



Palma MF 55TK36 – VT Stereo

Operating instructions

Contents

Remote control handset RK18	2	Blue Background During No-Signal ..	17
Control Panel Buttons	3	Volume Bar	17
Antenna Connections	3	AV Modes	17
Preparation	4	Teletext	17
Features	4	To operate Teletext	17
Safety Precautions	4	To select a page of Teletext	17
Before Switching on your TV	6	To Select Index Page	18
Power connection	6	To Select Teletext with a TV	
Connections to the RF input socket	6	Programme	18
How to connect other devices	6	Searching for a page while watching	
Inserting batteries in the remote control		TV	18
handset	6	To Select Double Height Text	18
Switching the TV ON/OFF	6	To Reveal "concealed" Information	18
To switch the TV on	6	To Stop Automatic Page Change	18
To switch the TV off	6	To Select a Subcode Page	18
Operating the TV	7	Fastext	18
A.P.S.	7	To exit Teletext	19
(Automatic Programming System)	7	To Display the Time	19
Operating with the buttons on the TV set	7	Connect Peripheral Equipment	19
Operating with Remote Control	7	Via the Euroconnector	19
Menu System	8	Via Ant Input	19
Sound Menu	9	Decoder	19
Picture Menu	11	TV and Video Recorder	19
Feature Menu	12	Copy Facility	21
Install Menu	13	Camera and Camcorder	21
Programme Menu	14	Search for and store the test signal of	
Other Features	16	the video recorder	21
TV Status	16	Connect the decoder to the video	
Programme Swap	16	recorder	21
Double-digit (- -)	16	Connecting Headphones	21
Personal Preferences	16	Tips	21
Sound Indicator	16	Care of the Screen	21
Sleep Timer Last Minute Indicator	16	Poor Picture	21
Mute Indicator	16	No Picture	21
No-Signal	17	Sound	21
		Remote Control	22
		No solution	22
		Specifications	22

Remote control handset RK18

The remote control handset sends its commands to the TV set with the aid of infra-red light. For this reason, it must always be pointed towards the TV set in order to operate correctly. Use of the remote control may possibly interfere with other devices or systems which are controlled by infra-red signals (such as infra-red headphones).

The remote control handset may not operate correctly if the TV set is exposed to direct sunlight, because the TV set is not able to detect the infra-red signals. The TV set must be switched on with its main switch before the remote control handset can be used.



Infra-red light!
Do not point the remote control handset at your eyes and press any of the buttons on it!

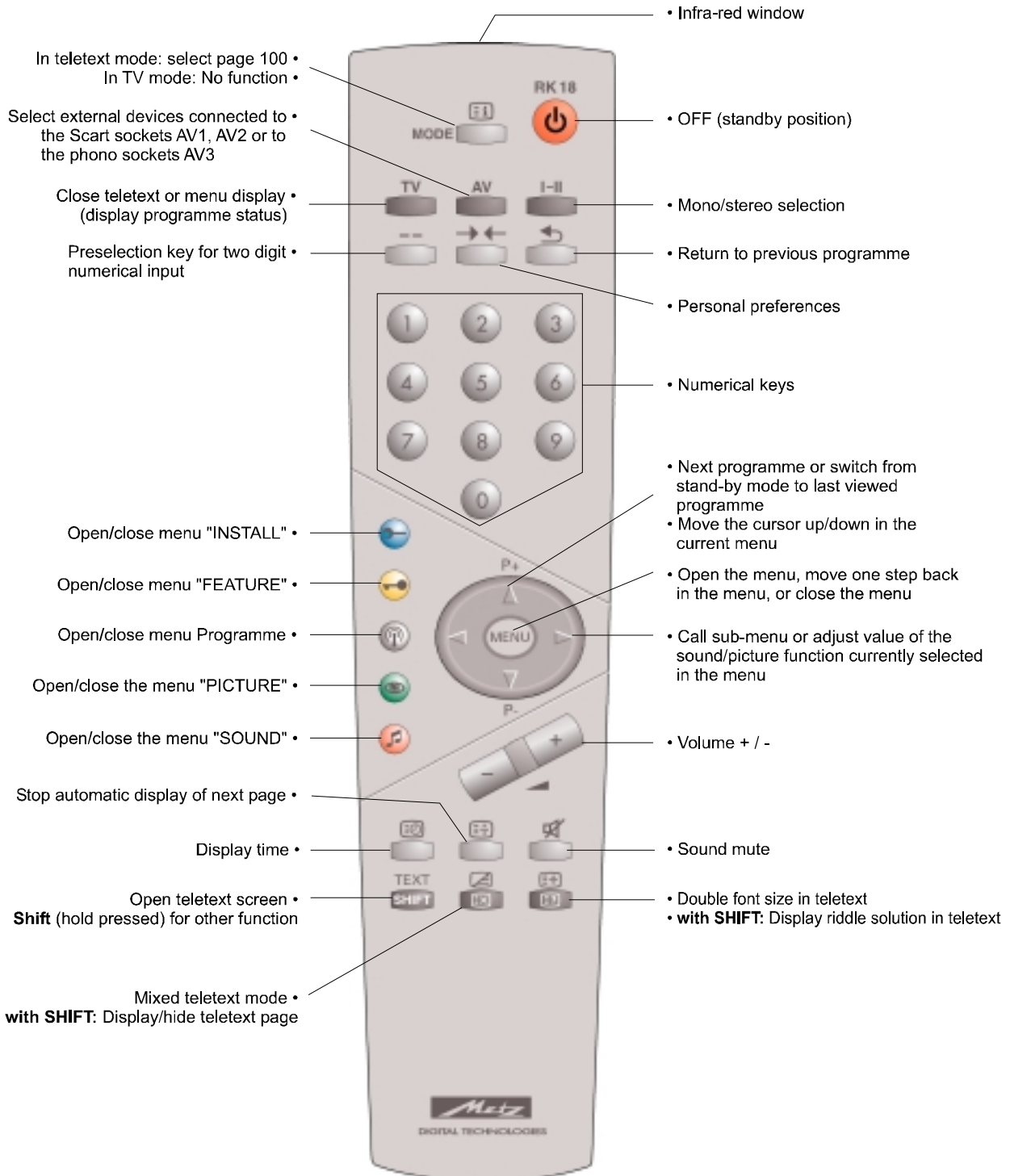

Control Panel Buttons

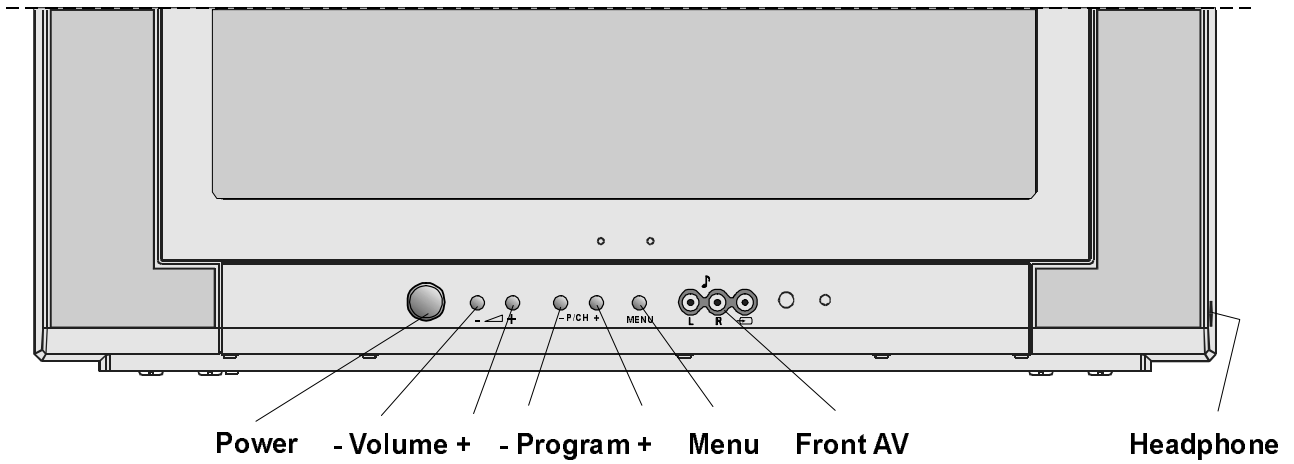

Antenna Connections

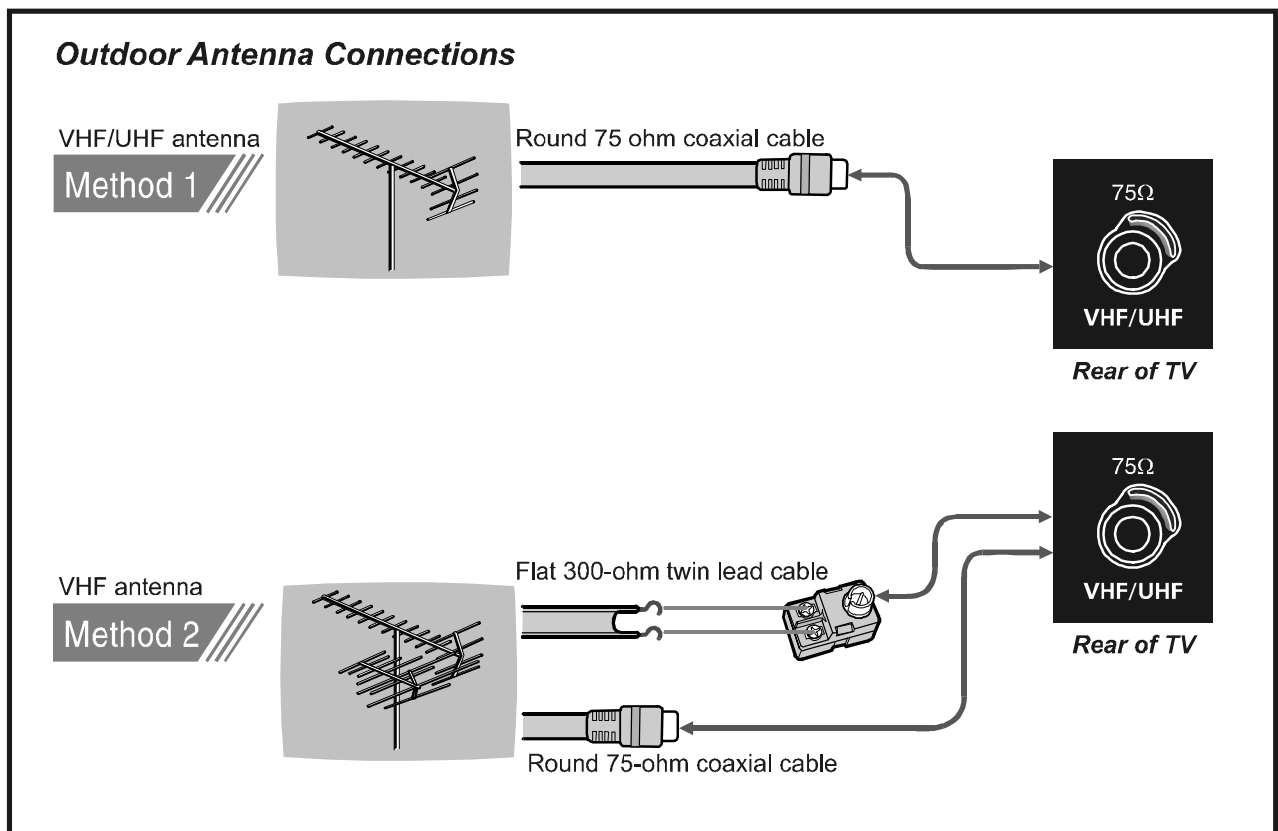

Preparation

For ventilation, leave a space of at least 10 cm free all around the set. To prevent any fault and unsafe situations, please do not place any objects on top of the set.

Use this apparatus in tropical and/or moderate climates.

Features

- It is a remote controlled colour television.
- 100 programmes from VHF, UHF bands or cable channels can be preset.
- It can tune cable channels.
- Controlling the TV is very easy by its menu driven system.
- It has Euroconnector socket for external devices (such as computer, video, video games, audio set, etc.)
- Second Euroconnector socket is available.
- Stereo sound system (German stereo) is available.
- Full function Teletext (Fastext, Toptext).
- It is possible to connect headphone.
- Direct channel access.
- A.P.S. (Automatic Programming System).
- All programmes can be named.
- Programme swapping between last watched two programmes.
- Forward or backward automatic tuning.
- Sleep timer.
- Automatic sound mute when no transmission.
- When no valid signal is detected, after 5 minutes the TV switches itself automatically to stand-by mode.
- WSS (Wide Screen Signaling).

Safety Precautions

1. Power Source

The receiver should be operated only from a **230V AC, 50 Hz** outlet. Ensure you select the correct voltage setting for your convenience.

2. Power Cord

The power supply cord should be placed so that it is not likely to be walked on or pinched by items placed upon them or against it. Pay particular attention to cord where it enters the plug, power outlet, and the point where it exits from the receiver.

3. Moisture and Water

Do not use this equipment in a humid and damp place (avoid the bathroom, the sink in the kitchen, and near the washing machine). Do not expose this equipment to rain or water, as this may be dangerous and do not place objects filled with liquids on top. Avoid from dripping or splashing.

4. Cleaning

Before cleaning, unplug the receiver from the main supply, outlet. Do not use liquid or aerosol cleaners. Use soft and dry cloth.

5. Ventilation

The slots and openings on the receiver are intended for ventilation and to ensure reliable operation. To prevent overheating, these openings must not be blocked or covered in anyway.

6. Lightning

In case of storm and lightning or when going on holiday, disconnect the power cord from the wall outlet.

7. Replacement Part

When replacement parts are required, be sure the service technician has used replacement parts which are specified by the manufacturer or have the same specifications as the original one. Unauthorised substitutions may result in fire, electrical shock, or other hazards.

8. Servicing

Please refer all servicing to qualified personnel. Do not remove cover as this may result in electric shock.

9. X-rays

The x-rays generated in this television are shielded sufficiently.

10. Naked Flame Sources

Do not place naked flame sources on the apparatus.

Warning!

Any intervention contrary to regulations, in particular, any modification of high voltage or a replacement of the picture tube may lead to an increased concentration of x-rays. Any television modified in this way no longer complies with license and must not be operated.

Instructions for waste disposal:

- *Packaging and packaging aids are recyclable and should principally be recycled. Packaging materials, such as foil bag, must be kept away from children.*
- *Batteries, including those which are heavy metal-free, should not be disposed of with household waste. Please dispose of used batteries in an environmentally sound manner. Find out about the legal regulations which apply in your area.*

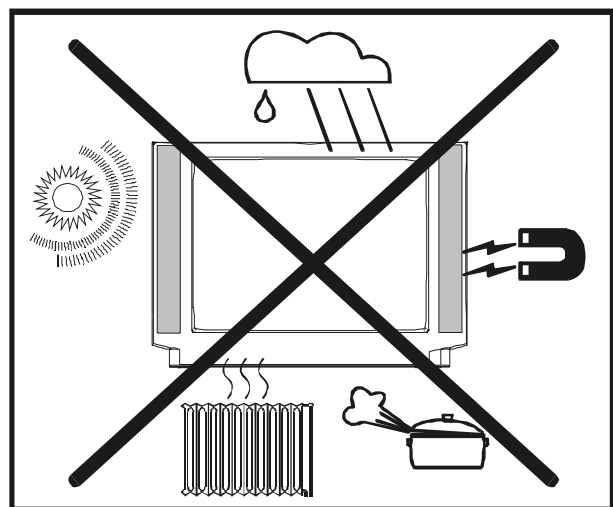
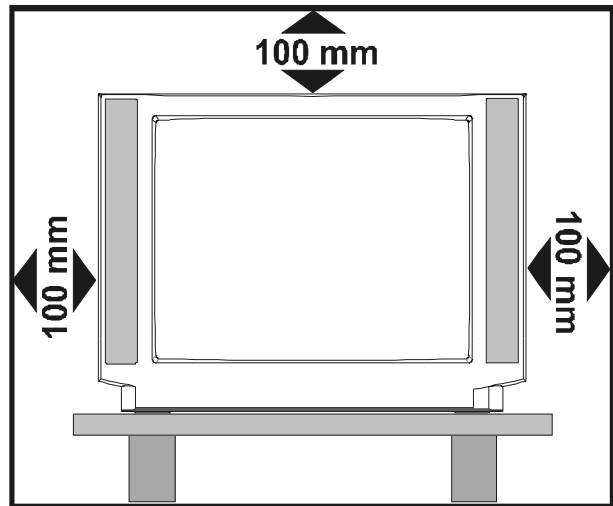

CAUTION

RISK OF ELECTRIC SHOCK



The lightning flash with arrowhead symbol, within an equilateral triangle, is intended to alert the user to the presence of uninsulated "dangerous voltage" within the product's enclosure that may be of sufficient magnitude to constitute a risk of electric shock of persons.



The exclamation point within an equilateral triangle is intended to alert the user to the presence of important operating and maintenance (servicing) instructions in the literature accompanying the appliance.

"DO NOT LEAVE YOUR TV AT STAND-BY OR OPERATING WHEN YOU LEAVE YOUR HOUSE"

Before Switching on your TV

Power connection

IMPORTANT: The TV set is designed to operate on **230V AC, 50 Hz**.

- After unpacking, allow the TV set to reach the ambient room temperature before you connect the set to the mains.

Connections to the RF input socket

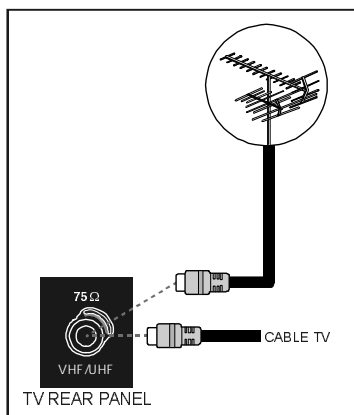

- Connect the aerial or cable TV plug to the RF input socket located at the back of the TV and connect the cable plug coming out from the TV out socket located at the devices (VCR, DVB etc.) to this socket as well.

How to connect other devices

IMPORTANT: Switch off the TV before connecting any external device.

Sockets for external connections are at the back and front of the TV. For connection of other devices via Euroconnector refer to the manuals of the related devices.

Inserting batteries in the remote control handset

- Place the batteries in the right directions as seen below.
- Remove the battery cover located on the back of the handset by gently pulling upwards from the indicated part.
- Insert two **LR03 AAA** or equivalent type batteries inside.
- Replace the battery cover.

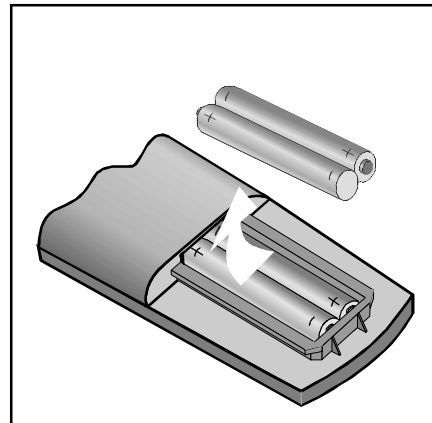

NOTE: Remove batteries from remote control handset when it is not to be used for a long period. Otherwise it can be damaged due to any leakage of batteries.

Switching the TV ON/OFF

To switch the TV on

Your TV will switch on in two steps:

- 1- Press the power button located on the front of the TV. Then the TV switches itself to standby mode and the **RED LED** located below the TV turns on.
- 2- To switch on the TV from stand-by mode either:

Press a digit button on the remote control so that a programme number is selected,

or,

Press Programme Up or Down buttons on the front of the TV or on the remote control, so that last switched off programme is selected.

By either ways the TV will switch on and the RED LED will turn GREEN.

To switch the TV off

- Press the stand-by button on the remote control, so the TV will switch to stand-by mode and the **GREEN LED** will become **RED**,

or,

Press the power button located on the front of the TV, so the TV will switch off and the GREEN LED will turn off.

Operating the TV

You can operate your TV both using the remote control handset and onset buttons.

A.P.S.

(Automatic Programming System)

"PLEASE, CHECK ANTENNA CABLE AUTO. PROGRAMMING SYSTEM" message will be displayed when you turn on your TV for the first time. APS, searches and sorts all channels and stores them automatically on your TV, according to the transmission of programme systems in your area.

To cancel APS before starting, press "TV" button. First of all choose the "COUNTRY". This, will effect the sort process in APS. To select "START" use "P+" or "P-" button and press "◀" or "▶" button. To cancel APS during running press "◀" or "▶" button.

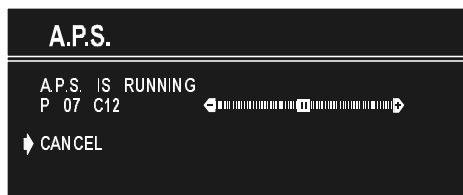
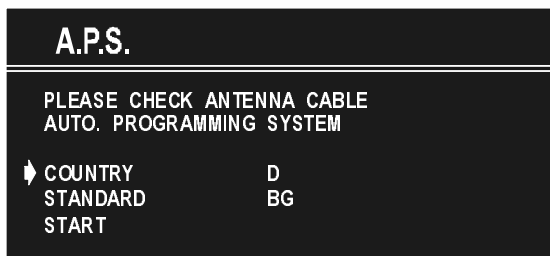

After APS is finalized, a programme list will appear on the screen. In the programme list you will see the programme numbers and names assigned to the programmes.

If you do not accept the locations and / or the programme names of programmes, you can change them in Programme menu.

Operating with the buttons on the TV set

Volume setting and programme selection can be made using the buttons on the front panel.

Volume Setting

- Press " - ▲ " button to decrease volume or " ▲ + " button to increase volume, so a volume level scale (slider) will be displayed at the middle of the bottom on the screen.
- By pressing both the " ▲ + " and " - ▲ " buttons at the same time you can enter Main menu.

Programme Selecting

- Press "P/Ch +" button to select the next programme or "- P/Ch" button to select the previous programme.

Entering Main Menu

- Press "MENU" button to enter Main menu. In the Main menu select sub-menu using "- P/Ch" or "P/Ch+" button and enter the sub-menu using " - ▲ " or " ▲ + " button. To learn the usage of the menus, refer to the Menu System section.

Operating with Remote Control

The remote control handset of your TV is designed to control all the functions of the model you selected. The functions will be described in accordance with the menu system of your TV.

Functions of the menu system are described in Menu System section.

Volume Setting

Press " ▲ + " button to increase volume. Press " - ▲ " button to decrease volume. A volume level scale (slider) will be displayed at the middle of the bottom on the screen.



Programme Selecting

(Previous or next programme)

- Press "P-" button to select the previous programme.
- Press "P+" button to select the next programme.

Programme Selecting (direct access):

Press digit buttons on the remote control handset to select programmes between 0 and 9. TV will switch to the selected programme. To select programmes between 10 - 99, you must use the double digit button "--".

P - - this OSD is displayed at the left hand upper on the screen.

After then, press the digit buttons consecutively which programme you want to select (eg. for programme 27, first press 2 and then 7). When it is late to press any digit button this function will be ignored and the display will be erased. In the same way it must not be late to press any digit button after entering the first digit. The limit of the delay time is 3 seconds.

Press directly the programme number to reselect single digit programmes.

Programme Swapping

- Press "↔" (programme swap) button to select the last selected programme. This button provides swapping between last two selected programmes. For example, select programme 8, then select programme 2. Now, if you press "↔" button, programme 8 will be selected. If you press the same button again, programme 2 will be selected and so on.

Menu System

Your TV has been designed with a menu system, to provide an easy manipulation of a multi-function system. The TV is controlled by choosing the commands, which are displayed on the screen.

Press the "MENU" button. The Main menu will be displayed at the middle on the screen.

All the selected items in this menu system is indicated with **CYAN** characters and with an arrow on the leftside of items.

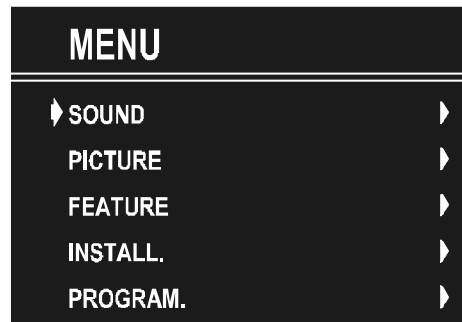

To select a sub-menu use "P+" or "P-" button, and press "◀" or "▶" button. Each option can also be selected with the coloured button and "📶" button on the remote control.

MAIN MENU

The menu system is described below.

The short way in order to enter the menus, press :

"MENU" Button, Main Menu.

Red (🎵) Button, Sound Menu.

Green (👁️) Button, Picture Menu.

Yellow (🔑) Button, Feature Menu.

Blue (🔑) Button, Install. Menu.

"📶" Button, Programme Menu.

Menu button has two functions; first is opening or closing the "MAIN MENU", and the second is closing the sub-menu and then opening its parent menu.

Sound Menu

To change sound settings

- Enter the Sound Menu directly, pressing the **RED** (🎵) button or,
- As you enter the main menu, sound will be the first selected option. In the main menu, select **SOUND** using “P+” or “P-” button, then enter the sound menu pressing “◀” or “▶” button.

Setting Volume:

As you enter the sound menu, Volume will be the first selected option.

- Press “▶” button to increase volume.
- Press “◀” button to decrease volume.

Or you can directly change the volume settings using “◀ +” (to increase) or “- ▶” (to decrease) button.

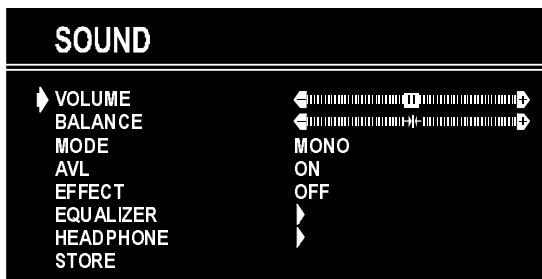

Setting Balance

It allows adjusting the distribution between the left and right speakers.

- Using “P+” or “P-” button select Balance.
- Press “▶” button to change balance rightward.
- Press “◀” button to change balance leftward.

When balance control is in mid position, the cursor is displayed with the two reciprocal arrows.

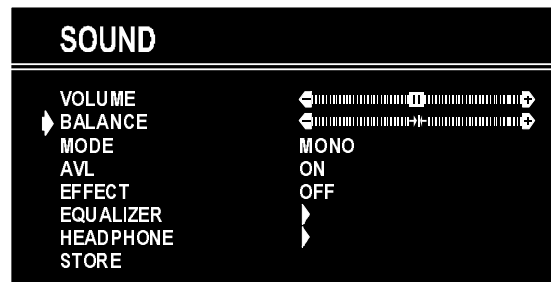

Selecting Mode

- Using “P+” or “P-” button select Mode.
- Press “◀” or “▶” button to change Mode.

You can choose **MONO**, **STEREO** or **DUAL (I-II)** mode, only if the selected channel supports that mode.

You can also change sound mode directly pressing “I-II” button on your remote control.

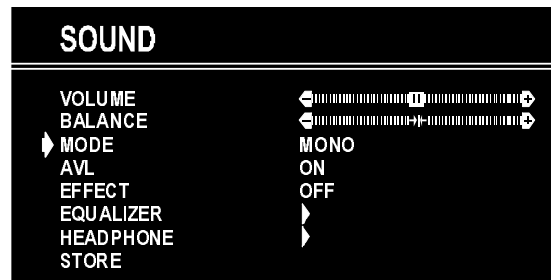

In case of bilingual broadcast (Dual Sound), you can select original or dubbed language using mode option.

Setting AVL

Automatic Volume Limiting (AVL) function normalises sound to obtain fixed output level between programs, having different sound levels. Pressing “◀” or “▶” button will turn on and off this feature.

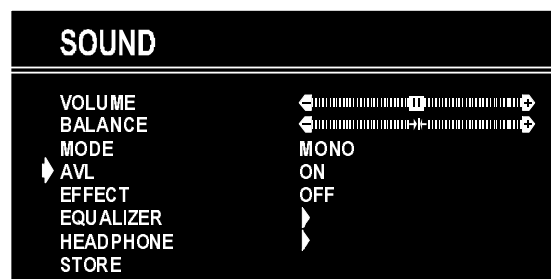

Setting Effect

You can use this feature to switch the sound effect on and off. Pressing “◀” or “▶” button will turn on and off this feature. If the current sound system is **MONO** and the sound effect is set **ON**, then the sound will be heard as if it is **STEREO**. If the current sound system is **STEREO**, switching this effect on will make the sound deeper. Switching it off will make no change in **MONO** and **STEREO**.

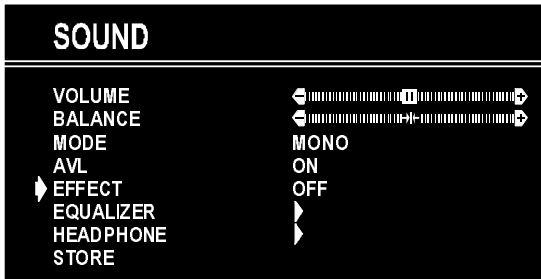

Equalizer

To enter Equalizer sub-menu, select Equalizer using “P+” or “P-” button, then enter Equalizer menu pressing “◀” or “▶” button.

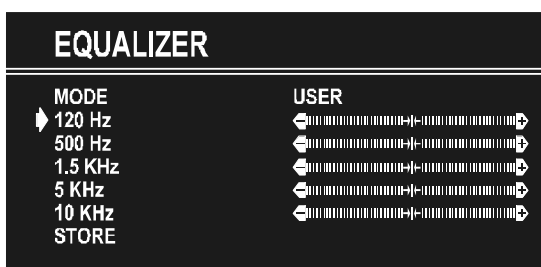
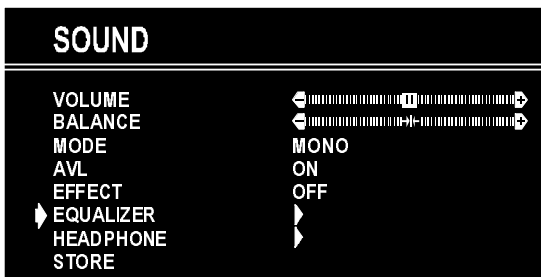

In MODE item there are five predefined and one user defined options. These are USER, CLASSIC, JAZZ, ROCK, POP and FLAT. The predefined options can not be changed by the user. If you change one of the frequency values of the predefined options, the MODE is switched automatically to USER option. The USER option may be adjusted by the user.

The 5 items below the MODE are available

to adjust the sound settings in 5 frequency values: 120 Hz, 500 Hz, 1.5 kHz, 5 kHz and 10 kHz. To change the values of 5 frequency options, select one of the options by “P+” or “P-” button, and then press “▶” to increase the value, or “◀” to decrease the value. In mid position, cursor is displayed with the two reciprocal arrows.

To store the Equalizer settings, press “◀” or “▶” button on “STORE” option.

During the store process all the items are stored, moreover, the USER mode information would not be lost. In other words, when the user mode is selected again, after storing the MODE with one of the predefined options, the user defined frequency values would be set.

To Change Headphone Sound Settings

Pressing “◀” or “▶” button on **HEADPHONE**, enter the Headphone menu. This is a sub-menu of Sound menu, and all options in this menu are working as the same in the Sound menu.

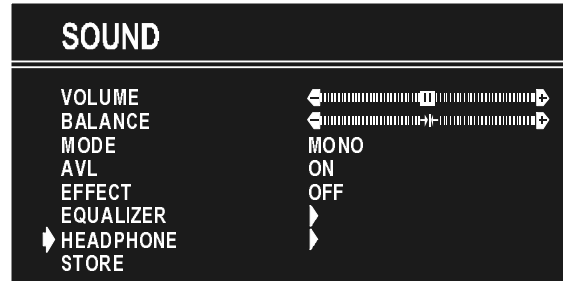

Setting Headphone Volume

- As you enter the Headphone sound menu, Volume will be the first selected option.
- Press “▶” button to increase volume.
- Press “◀” button to decrease volume.



Setting Headphone Balance

- When balance control is in mid position, the cursor is displayed with the two reciprocal arrows.
- Using "P+" or "P-" button select Balance.
- Press "▷" button to change balance rightwards.
- Press "◁" button to change balance leftwards.

Setting Headphone Mode

- Using "P+" or "P-" button select Mode.

Pressing "◁" or "▷" button will change the current sound mode. (e.g.: If the current sound mode is stereo, it will be stereo or visa versa).

In case of bilingual broadcast, you can select original or dubbed language again using mode menu. So when somebody listens to the original language from the loudspeakers, somebody else can listen to the dubbed language from headphone.

To Store the Settings

- Using "P+" or "P-" button select Store. Press "◁" or "▷" button to store current headphone volume and balance. The stored values will be valid for all the programmes.

To Store the Settings

- Press "◁" or "▷" button on "STORE" option to store Sound menu settings.

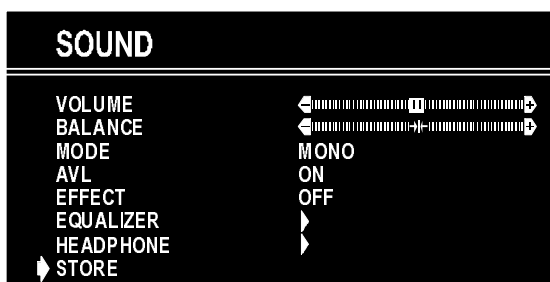

Picture Menu

- To enter the Picture menu directly, press the "GREEN" (👁️) button, or
- Press "MENU" button, now you are in Main menu. In the Main menu, select "PICTURE"

using "P+" or "P-" button, then enter the Picture menu pressing "◁" or "▷" button.

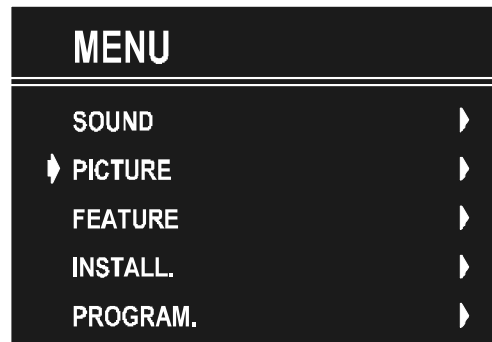

Setting Brightness

- As you enter the picture menu, Brightness will be the first selected option.
- Press "▷" button to increase brightness.
- Press "◁" button to decrease brightness.

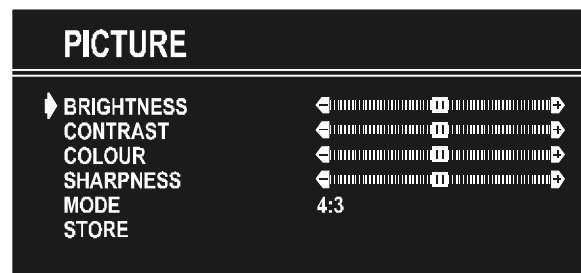

Setting Contrast

- Using "P+" or "P-" button select Contrast.
- Press "▷" button to increase contrast level.
- Press "◁" button to decrease contrast level.



Setting Colour

- Using "P+" or "P-" button select Colour.
- Press "▷" button to increase colour level.
- Press "◁" button to decrease colour level.



Setting Sharpness

- Using “P+” or “P-” button select Sharpness.
- Press “▷” button to increase peaking level.
- Press “◁” button to decrease peaking level.



Mode

This item is used to change the picture size.

By pressing “◁” or “▷” button you may choose one off three options. These are, “4:3”, “16:9” and “AUTO”.

- **4:3** This option forces the picture ratio to 4:3 mode.
- **16:9** This option forces the picture ratio to 16:9 mode.
- **AUTO**: This allows to change the picture mode automatically, according to the transmission of the selected channel. For example, your TV is 4:3 mode, but the transmission of that channel is in 16:9 mode. If you select the AUTO mode, the TV is switched to 16:9 mode automatically. If the TV is in 4:3 mode and the picture ratio of the channel is also 4:3, there will be no affect selecting the picture mode to AUTO mode.

In RGB and S-VHS modes the Picture Mode can be 4:3 or 16:9 (Auto mode is not available.).



To Store the Settings

- Press “◁” or “▷” button on **STORE** option to store Picture menu settings.

The stored picture mode setting will be valid only in current program. However, the other stored values in Picture Menu will be valid for all the programmes.

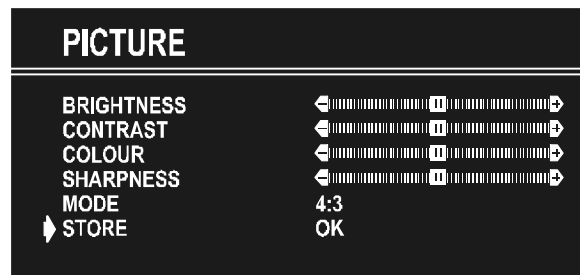

Feature Menu

- To enter the Feature menu directly, press the “YELLOW” (⌨) button, or
- Press “MENU” button, now you are in Main menu. In the Main menu, select **FEATURE** using “P+” or “P-” button. Then enter the Feature menu pressing “◁” or “▷” button.

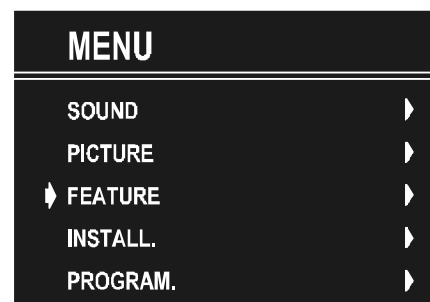

Sleep Timer

As you enter the Feature menu, **SLEEP TIMER** will be the first selected option. Use “◁” or “▷” button to change the Sleep Timer values between **OFF, 0:15:00, 0:30:00, 0:45:00, 1:00:00, 1:15:00, 1:30:00, 1:45:00** and **2:00:00**.

It is displayed on the upper right of the screen. If sleep timer is activated it is displayed with the TV status and erased with it after 3 seconds.

0:15 : 00

FEATURE	
▶ SLEEP TIMER	OFF
CHILD LOCK	OFF
LANGUAGE	ENGLISH
AV-2 OUTPUT	TV

If there is left only one minute of the down counting of the timer, it is displayed automatically on the upper right of the screen, and stayed there until finishing. Then TV goes automatically to stand-by.

Child Lock

You can use this feature to prevent children turning on TV or changing programs or adjustments etc. without remote control.

The **CHILD LOCK** feature can be set by “◀” or “▶” button to either **ON** or **OFF**. When **OFF** is selected, there will be no difference in the operation of your TV. When **ON** is selected, the TV can only be controlled by the remote control handset. In this case, the front panel buttons (except the Switch On/Off button) will not work.

FEATURE	
▶ SLEEP TIMER	OFF
▶ CHILD LOCK	OFF
LANGUAGE	ENGLISH
AV-2 OUTPUT	TV

Selecting Menu Language

Menu language can be chosen by pressing “◀” or “▶” button on **LANGUAGE** item.

FEATURE	
SLEEP TIMER	OFF
CHILD LOCK	OFF
▶ LANGUAGE	ENGLISH
AV-2 OUTPUT	TV

AV-2 OUTPUT

From AV-2 Output, either TV or AV-1 can be given. TV or AV-1 can be chosen by pressing “◀” or “▶” button on "**AV-2 OUTPUT**".

FEATURE	
SLEEP TIMER	OFF
CHILD LOCK	OFF
LANGUAGE	ENGLISH
▶ AV-2 OUTPUT	TV

To Store Settings

In Feature menu all settings are stored automatically.

Install Menu

- To enter the Install menu directly, press the **BLUE** (ⓘ) button, or
- Press "**MENU**" button, now you are in Main menu. In the Main menu, select "**INSTALL.**" using "**P+**" or "**P-**" button. Then enter the Install menu pressing “◀” or “▶” button.

MENU	
SOUND	▶
PICTURE	▶
FEATURE	▶
▶ INSTALL.	▶
PROGRAM.	▶

Selecting Programme

To select programme number, you can use “◀” or “▶” button, Digit Buttons or The Double Digit button with digit buttons.

Selecting Band

BAND, can be chosen either,

- “C” or “S” by “◀” or “▶” button.

Selecting Channel

CHANNEL can be changed by “◀” or “▶” button, by Digit Buttons or by the Double Digit button with digit buttons.

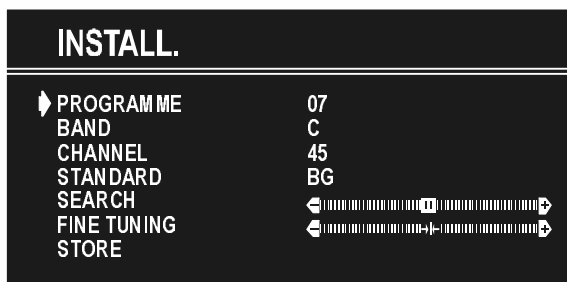

For band C,

01 - 83.

For band S,

01 - 41.

Standard

The "Standard" setting is fixed to "BG". You cannot change this item's setting.

Selecting Search

To start the search process, press "▷" button for forward search or "◁" button for backward search. **SEARCH** item blinks during search process, since the process is stopped or signal is found. During search process the semi-transparent menu background becomes "BLUE". To stop the search process "◁" or "▷" button must be pressed again.

Selecting Fine Tuning

You can use the Fine Tuning process for fine adjustment (after coarse adjustment), if you are not happy about the image on the screen.

Use "◁" or "▷" button on **FINE TUNING** item, until getting the best image on the screen.

In Channel option, normally the Fine Tuning cursor is placed at the middle on the slider, and this is indicated with the two reciprocal arrows.

To Store Settings

Press "◁" or "▷" button on **STORE** option to store Install menu settings.

Programme Menu

- To enter Programme menu directly, press the "Ⓜ" button, or

- Press "MENU" button, now you are in Main menu. In the Main menu, select "PROGRAM." using "P+" or "P-" button. Then enter the Programme menu pressing "◁" or "▷" button.

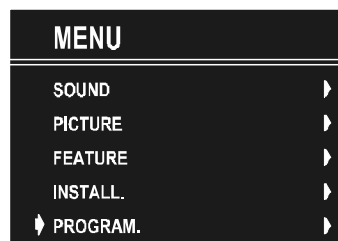

Moving cursor to four direction you can reach 30 programmes in the same page. By scrolling the pages up or down by pressing the navigation buttons you can select all the programmes in TV mode (except the AV mode).

In menus, "P+" and "P-" buttons are working like "Direction Up" and "Direction Down".

By cursor action, programme selection is done automatically. Selected programme is displayed with "CYAN" characters. In order to select programme is also possible by using digit or double-digit button. In this way programme selection gets also automatically and after selection the selected programme is displayed with cyan characters. The TV Status is changed by the programme selection too. When using double-digit button in order to select a programme, the Programme Number in TV Status OSD is displayed in "P --" form, and by pressing digit buttons they are displayed in it.

Programme Number is between 00 and 99. Programme Name has a name string with 5 characters.

At the bottom of the menu there is a programme sort functions section. Each function is activated by color button (seen above). **NAME** allows changing the programme name. By **DELETE** you can delete programmes that you decided. **INSERT** section is for inserting programmes into another programme spaces. By selecting **AUTOSTORE** section, A.P.S. menu will be available.

To change the name of a decided programme, that programme is selected and

pressed to the **RED** (🎵) button (**NAME**). The first letter begins to blank on the selected name. To change that letter "P+" or "P-" button can be used, and to select the other letters, "◀" or "▶" button can be used. If the cursor is at the last letter of the Programme Name, pressing "▶" button moves the cursor at the beginning. On the contrary, if the cursor is at the beginning of the Programme Name, pressing "◀" button moves the cursor at the end.

PROGRAM.			
▶ 01	C-12	11	-----
02	C-23	12	-----
03	C-45	13	-----
04	C-47	14	-----
05	C-50	15	-----
06	C-55	16	-----
07	-----	17	-----
08	-----	18	-----
09	-----	19	-----
10	-----	20	-----
		21	-----
		22	-----
		23	-----
		24	-----
		25	-----
		26	-----
		27	-----
		28	-----
		29	-----
		30	-----

■ NAME	■ DELETE
■ INSERT	■ AUTOSTORE

After changing the name by pressing the **RED** (🎵) button (**STORE**) it is stored. After activating the name process the "INSERT", "DELETE" and "AUTOSTORE" processes will be inactive and "CANCEL" option will be valid. This option cancels the name process, if the new name do not want to be stored.

■ STORE	■ CANCEL
■	■

When it is pressed to **GREEN** (👁) button (**INSERT**), "NAME", "AUTOSTORE" and "DELETE" functions are erased, the selected programme is displayed with green characters. From now on, the automatic selection is canceled. Cursors moves are indicated with "CYAN" characters. With navigation buttons, the decided program space can be selected and by pressing the green button again inserting is occurred to that space.

It should be thought that Prog-00 is the lowest programme (like Prog-100). If any programme is inserted to Prog-00, the

programmes under that programme space shift one up, and Prog-99 is adjusted to the first frequency value of VHF1 (44 MHz).

If Prog-00 is inserted to any programme space, all the programmes under that space shift one down and Prog-99 is erased, and Prog-00 is adjusted to the first frequency value of VHF1 (44 MHz).

"CANCEL" function cancels the activated "INSERT" process.

For "DELETE" process it is pressed to **YELLOW** (🔑) button, ("NAME", "INSERT" and "AUTOSTORE" functions are inactive). Pressing yellow button again erases the selected programme from the programme list, and the programmes below shift one up. Prog-00 is adjusted to the first frequency value of VHF1 (44 MHz). Pressing blue button cancels the activated "DELETE" process.

To enter Autostore menu, press to the **BLUE** (🔑) button. To learn the features of this function see "A.P.S" below.

APS, searches and stores all channels automatically on your TV, according to the transmission of programme systems in your area.

A.P.S.	
PLEASE CHECK ANTENNA CABLE AUTO. PROGRAMMING SYSTEM	
▶ COUNTRY	D
STANDARD	BG
START	

A.P.S.	
A.P.S. IS RUNNING	
P 07 C12	◀■■▶
▶ CANCEL	

To cancel APS before starting, press "TV" button. First of all choose the "COUNTRY". This, will effect the sort process in APS. To select "START" use "P+" or "P-" button and

press “◀” or “▶” button. To cancel APS during running press “◀” or “▶” button.

After APS is finalized, a programme list will appear on the screen. In the programme list you will see the programme numbers and names assigned to the programmes.

If you do not accept the locations and / or the programme names of programmes, you can change them in Programme menu.

Other Features

TV Status

Programme Number, Programme Name (or **AV**), (they are displayed on the upper left of the screen) and **Sleep Timer** (shows the time left on the upper right screen if enabled). In stereo options the sound indicator is displayed with them too. They are displayed after programme change during 3 seconds.

P 01 Programme Number

PR-01 Programme Name (5 characters)

These OSD's are displayed when a new programme is entered by digit button, by pressing “↵” button, or by “P+” or “P-” button, or by “TV” button.

Programme Swap (↵)

This button is used to reenter to the preceding entered programme again. Pressing “↵” consecutively allows to swap into two last entered programmes.

Double-digit (- -)

This OSD is displayed when the "Double-Digit" button pressed in place of the programme number indicator.

P - -

After then, in order to enter a programme it must be pressed to two digit consecutively. When it is late to press any digit button this function will be ignored and the display will be erased. In the same way it must not be late to press any digit button after entering

the first digit. The limit of the delay time is 3 seconds.

Personal Preferences (→←)

All the preset values will be restored, when pressing “→←”.

PP

Sound Indicator

This is a stereo option. The alternatives of the indicator are Mono, Stereo, Dual I and Dual II. This indicator is displayed under the programme number indicator on the screen. "I-II" button is used to select Mono or Stereo, or Dual I or Dual II.

MONO

In Mono broadcast or in forced-mono (for stereo broadcast).

STEREO

In Stereo broadcast.

DUAL I

If dual broadcast detected. Dual I is selected in default and also can be selected after Dual II by Remote Control.

DUAL II

If Dual II selected by Remote Control.

Sleep Timer Last Minute Indicator

It is displayed on the upper right of the screen. If sleep timer is activated it is displayed with the TV status and erased with it after 3 seconds.

If there is left only one minute of the down counting of the timer, it is displayed automatically on the upper left of the screen, and stayed there until finishing. Then TV goes automatically to stand-by.

0:15:00

Mute Indicator

It is placed in the upper middle of the screen when enabled, and it stays there until it is disabled.

🔇

To cancel mute, there is two alternative; the first one is pressing to "🔊" button, thus volume is set to the preceding value, and the second one is increasing the volume level, thus it starts at the minimum level to increase. By decreasing the volume level in mute state, mute will not be ignored, only the volume level will decrease. If mute canceled after decreasing the volume level, the volume will valid with the decreased level.

No-Signal

No-Signal Timer Indicator

It is displayed in the middle of the screen when no valid signal detected. It shows the remained time for the switching to the Stand-By mode (it takes 5 minutes when any signal detected or no any Remote Control command is accessed). The indicator is displayed in 3 seconds when there is no valid signal.

After an Remote Control command (if No-Signal Timer is active) the timer stops and if no signal detected again the timer is initialized to 5 minutes and starts 3 seconds later again to count down.

It is not valid in AV mode.

05 : 00

Blue Background During No-Signal

In case, no valid signal is detected AV mode. Blue Background is activated. During search process Blue Background is not active. But instead of it there is another feature given; the semi-transparent menu background is made blue.

Volume Bar

It is displayed in the lower middle of the screen. When a volume command is received (pressing ◀ + or - ▶ by Remote Control or Front panel) and no menu is active, it stays on the screen for 3 seconds, after the last volume command or until another command is received in between.



AV Modes

By pressing the "AV" button you can switch your TV to AV modes (except being in Teletext). Pressing this button consecutively will switch the TV in one off the AV modes: AV1, AV2, RGB, SVHS or FAV (Front AV).

AV1 supports the RGB mode. But if there is some colour problem in AV1 or AV2 modes, please force the AV mode to RGB or SVHS mode.

In order to quit the AV mode press the "TV", digit buttons, "P+" / "P-" button.

Teletext

Teletext is an information system that displays text on your TV screen. Using the Teletext information system you can view a page of information on a subject that is available in the list of contents (index).

On screen display is not available in text mode.

Contrast, brightness or colour control is not available, but volume control is available in text mode.

To operate Teletext

- Select a TV station on which Teletext is being transmitted.
- Press (TELETEXT) "TEXT" button. Usually the list of contents (index) is displayed on the screen.

To select a page of Teletext

- Press the appropriate digit buttons for the required Teletext page number.



The selected page number is displayed at the top left corner of the screen. The Teletext page counter searches until the selected page number is located, so that the desired page is displayed on the screen.

- Press "P+" button to move the Teletext screen forward one page at a time.
- Press "P-" button to move the Teletext screen backward one page at a time.



To Select Index Page

- To select the page number of the index (generally page 100), press “” button.



To Select Teletext with a TV Programme

- Press “” button. The text is now superimposed over the programme on the screen.
- Press “” button again to return to the Teletext page.



Searching for a page while watching TV

- While Teletext Mode is on, pressing **SHIFT** and “” buttons together will change the mode to TV, one more press to these buttons together will change the mode from TV to the latest Teletext page we left. In the TV mode enter a page number using digit keys. As you enter digits first line of teletext page will appear on top screen and will remain there until the requested page is found. Then teletext line will be replaced by page number to indicate that page has been found. Now you can display this teletext page pressing **SHIFT** and “” buttons together.

To Select Double Height Text



- Press “” button for the top half of the information page to be displayed in double height text.
- Press “” button again for the bottom half of the information page to be displayed in double height text.
- Press “” button once more for the full page of normal height text.

To Reveal “concealed” Information

- Pressing **SHIFT** and “” buttons together once will reveal answers on a quiz or games page.
- Pressing **SHIFT** and “” buttons together again will conceal the revealed answers.



To Stop Automatic Page Change

The teletext page you have selected may contain more information than what is on the screen; the rest of the information will be displayed after a period of time.

- Press “” button to stop the automatic page change.
- Press “” button again to allow the next page to be displayed.

To Select a Subcode Page

Subcode pages are subsections of long Teletext pages that can only be displayed on the screen one section at a time.

- Select the required Teletext page.
- Press “” button.
- Select the required subcode page number by pressing four digit buttons (e.g. 0001).
- If the selected subcode page is not displayed in a short time, press **SHIFT** and “” buttons together. TV programme will be displayed on the screen.
- Teletext page number will be displayed on the upper left corner of the screen when the selected page is found.
- Press **SHIFT** and “” buttons together to display the selected Teletext page.

Fastext

Teletext mode will be selected according to transmission automatically.

Your CTV supports the 7 page Teletext system. When the page number of any of the 7 pages in memory is entered, the system will not search for the requested page; instead it will display the page automatically.

- Press “**P+**” button to move the Teletext screen forward one page at a time.
- Press “**P-**” button to move the Teletext screen backward one page at a time.

For Fastext

The subject-heading for the information may have a particular colour or can be in a form located in a coloured box.

- Press an appropriate **RED** (🎵), **GREEN** (👁️), **YELLOW** (🔑) or **BLUE** (🔑) button in order to reach the relevant page quickly.

For Teletext

If Teletext transmission is present, colour coded buttons will appear in status row.

If Teletext transmission is not present, status row will not appear.

In Top mode the “P+” or “P-” commands will request the next or previous page respectively. If Teletext transmission is not available, in case of operation of these commands, wraparound occurs.

To exit Teletext

- Press “TV” button. The screen will switch to TV mode.

To Display the Time

- While watching a TV programme with Teletext transmission press “⌚” button. The current time information, captured from Teletext will be displayed at the upper middle of the screen.
- If the programme being watched does not have Teletext transmission, no information will be displayed.

Connect Peripheral Equipment

There is a wide range of audio and video equipment that can be connected to your TV.

The following connection diagrams show you where the different equipment should be connected at the back or the front side of the TV.

Via the Euroconnector

Your TV set has a Euroconnector socket. If you want to connect peripherals (e.g. video, decoder, etc.) which have Euroconnectors, to your TV, use **SCART1** or **SCART2** inputs.

If an external device is connected via Euroconnector sockets TV is switched to AV mode automatically. If the signal is RGB then the RGB OSD indicator is displayed on the screen.

In AV mode if you press the “📶” button the TV status OSD is displayed on the screen.

Via Ant Input

If you want to connect to your TV, peripherals like video recorders or decoders, but the device you want to connect does not have Euroconnector, you should connect it to the ANT input of your TV set.

If the VCR is connected via antenna input it is suggested to use the Programme 0.

Decoder

Cable TV offers you a wide choice of programmes. Most of them are free, others are to be paid for by the viewer. This means that you will need to subscribe to the broadcasting organisation whose programmes you wish to receive. This organisation will supply you a corresponding decoder unit to allow the programmes to be unscrambled.

For further information ask your dealer. See also the booklet supplied with your decoder.

Connect a decoder with an aerial socket to the TV

- Connect the aerial cable.

Connect a decoder without an aerial socket to the TV

- Connect the decoder to your TV with a eurocable (RCA Jack Cable) to **EXTERNAL**. When your decoder has a Euroconnector you can obtain better picture quality if you connect a eurocable to **EXTERNAL**.

TV and Video Recorder

- Connect the aerial cables.

Better picture quality can be obtained if you also connect a eurocable to **EXTERNAL sockets**.

Connect Peripheral Equipment

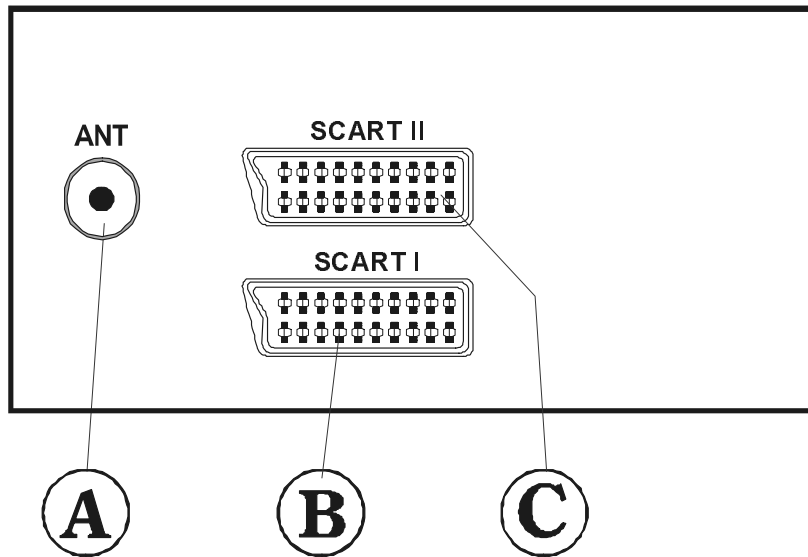

- A** ANTENNA
- B** Scart 1
- C** Scart 2

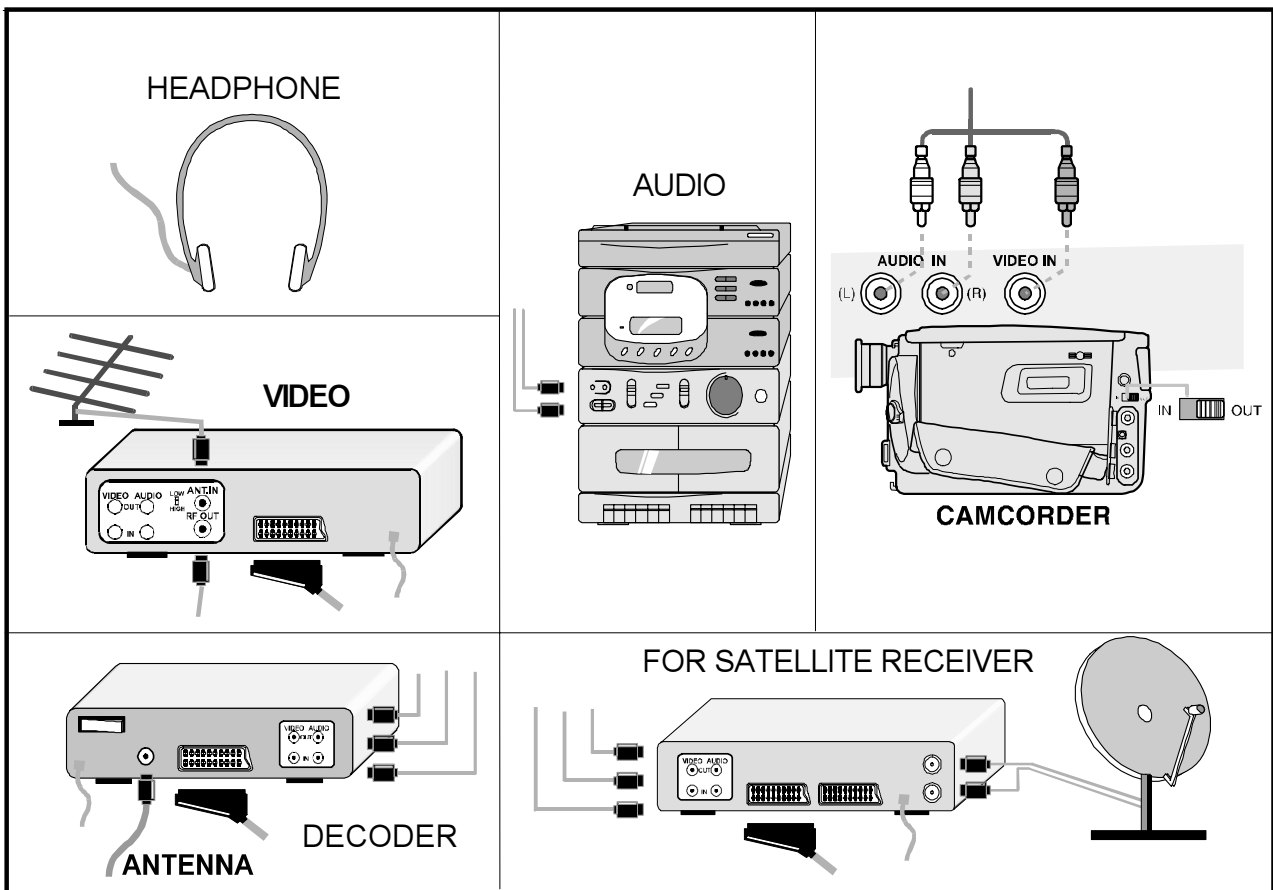

Copy Facility

Source selection for **VCR** recording.

- Select Features Menu in the Main Menu.
- Select **AV-2 OUTPUT** source pressing “◀” or “▶” button.

Camera and Camcorder

To connect to Front-AV input (FAV):

Connect your camera or camcorder at the front side of your TV.

- Connect your equipment to the TV via **VIDEO** (yellow), **AUDIO R** (red) and **AUDIO L** (white) inputs. You should connect the jacks to the input in the same colour.

Search for and store the test signal of the video recorder

- Unplug the aerial cable from the aerial socket “**ANT**” of your video recorder.
- Switch on your TV and put the video recorder on the test signal. (See the handbook for your video recorder.)
- Enter the Tuning menu via the Install menu.
- Search for the test signal of your video recorder in the same way as you searched for and stored the TV signals. See Tuning, Search and Store TV channels. Store the test signal under programme number 0.
- Replace the aerial cable in the aerial socket “**ANT**” of your video recorder once you have stored the test signal.

Connect the decoder to the video recorder

Some video recorders have a special euroconnector for decoder.

- Connect a eurocable to the euroconnector of your decoder and to the special euroconnector of your video recorder. See also the handbook of your video recorder.
- To connect your video recorder to the TV, see TV and Video Recorder section.

If you want to connect more equipment to your TV, consult your dealer.

Connecting Headphones

Use the stereo headphone socket (HP) on the lower front / right side of your TV, to connect headphones.

Tips

Care of the Screen

Clean the screen with a slightly damp, soft cloth. Do not use abrasive solvents as they may damage the TV screen coating layer

Poor Picture

Have you selected the correct TV system? Is your TV set or house aerial located too close to the loudspeakers, non-earthed audio equipment or neon lights, etc. ?

Mountains or high buildings can cause double pictures or ghost images. Sometimes you can improve the picture quality by changing the direction of the aerial.

Is the picture or Teletext unrecognisable? Check if you have entered the correct frequency.

The picture quality may degrade when two peripherals are connected to the TV at the same time. In such a case, disconnect one of the peripherals.

No Picture

Is the aerial connected properly? Are the plugs connected tightly to the aerial socket? Is the aerial cable damaged? Are suitable plugs used to connect the aerial? If you are in doubt, consult your dealer.

No Picture means that your TV is not receiving any transmission. Have you pressed the correct keys on the remote control? Try once more.

Sound

You can not hear any sound. Did you perhaps interrupt the sound, pressing “” key? Are external speakers connected to the TV?

Sound is coming from only one of the speakers. Is the balance set to one direction extreme? See SOUND menu.

Remote Control

Your TV no longer responds to the remote control. Press the "TV" button on the remote control once more. Perhaps the batteries are exhausted. If so you can still use the local keys at the front of your TV.

Have you selected the wrong menu? Press "TV" key to return to TV mode or press "MENU" to return to the previous menu.

No solution

Switch your TV set off and on. If this does not work, call the service personnel; never attempt to repair it yourself.

Cleaning The Screen

Your TV is fitted with a „True Flat" picture tube. The surface of the screen is covered with a foil. Under no circumstances may this be damaged.

To clean

Clean the laminated screen with a soft cotton cloth. Only non-alkaline, thinned soapsuds on a basis of water or alcohol be used to moisten the cloth. Rub the surface gently with the cloth until the surface is completely dry.

Under no circumstances...

may the screen be wiped with conventional glass cleaning fluid.

may the screen be brought into contact with abrasive materials.

may soiling be removed by polishing or scouring.

To clean off sticky substances, the cloth can be moistened with acetone.

Under no circumstances clean with this acetone cloth the TV-Cabinet.

Specifications

TV BROADCASTING

PAL B/G

RECEIVING CHANNELS

VHF (BAND I/III)

UHF (BAND U)

HYPERBAND

CABLE TV (S1-S20/ S21-S41)

NUMBER OF PRESET CHANNELS 100

CHANNEL INDICATOR

On Screen Display

RF AERIAL INPUT

75 Ohm (unbalanced)

OPERATING VOLTAGE

230V AC, 50 Hz.

AUDIO OUTPUT

German Stereo

AUDIO OUTPUT POWER ($W_{RMS.}$) (%10 THD)

2 x 8

POWER CONSUMPTION (W) (max.)

95

PICTURE TUBE

21" (55 cm)

DIMENSIONS (mm)			
D	L	H	Weight (kg)
476	600	450	22

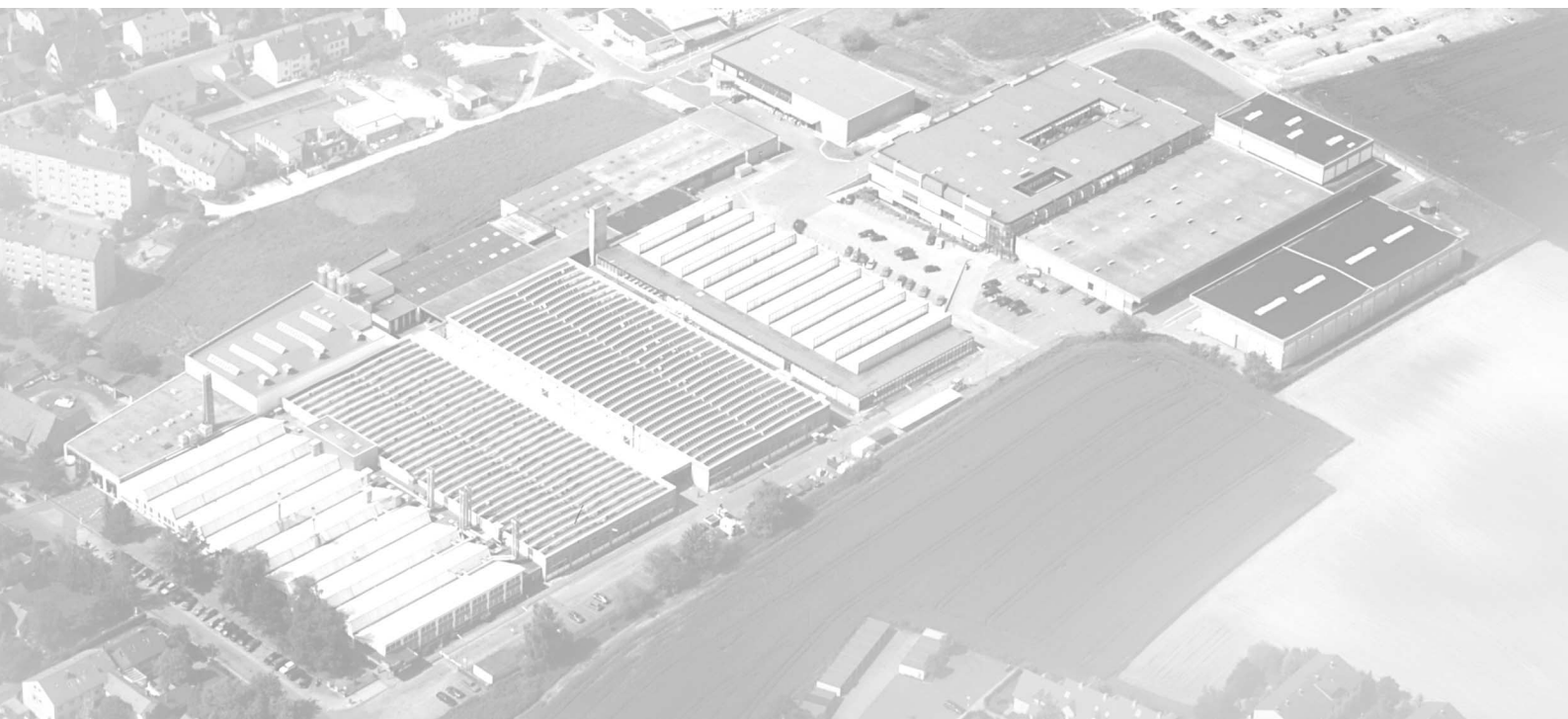

Metz - Werke GmbH & Co KG • Postfach 1267 • D-90506 Zirndorf • info@metz.de • www.metz.de



Unterhaltungselektronik



Fotoelektronik

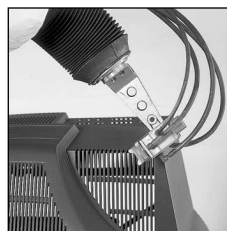

Kunststofftechnik



Industrieelektronik

Metz. Always first class.



Free Manuals Download Website

<http://myh66.com>

<http://usermanuals.us>

<http://www.somanuals.com>

<http://www.4manuals.cc>

<http://www.manual-lib.com>

<http://www.404manual.com>

<http://www.luxmanual.com>

<http://aubethermostatmanual.com>

Golf course search by state

<http://golfingnear.com>

Email search by domain

<http://emailbydomain.com>

Auto manuals search

<http://auto.somanuals.com>

TV manuals search

<http://tv.somanuals.com>