

HOME ENTERTAINMENT

Operating instructions
for all LCD-TV sets



- Bild und Ton
- AV Geräte
- Sondertabelle
- Timer
- Konfiguration



Foreword

Dear customer,
thank you for selecting a Metz
LCD TV set.

We have equipped this TV set
with a menu system which uses
"file cards" and believe that this
will provide you with a user
interface that is easy to under-
stand.

If you have any problems, you
can press the "INFO" key to
display a help function that will
assist you in setting up your TV
set.

However, you should read at
least sections 1 to 8 of the Ope-
rating Instructions before putting
your new TV set into service.

**This LCD TV is HD-ready and
supports HDTV broadcasts.**

HD
ready The HD ready Logo is a
Trademark of EICTA.

Your METZ-WERKE

Metz-Werke GmbH & Co KG
Postfach 1267
D-90506 Zirndorf/Germany

Fon: +49 911/97060
Fax: +49 911/9706340
www.metz.de
info@metz.de

Contents

Basic functions	1	Installation	4
	2.	Safety notes	5
	3.	The Remote Control	6
	4.	Daily Operation	8
	5.	Selecting the Operating Mode.	8
	6.	Station Selection.	9
	7.	User Help (Information).	10
	8.	Menu Control.	11
	9.	Teletext	12
	10.	AV Playback	15
Extended functions	10.1	AV Playback VCR function	17
	11.	General Picture Settings	18
	11.1	Picture Settings for Progr. via TV Menu.	20
	11.2	Picture Settings for Progr. via Station Table	21
	12.	General Sound Settings	22
	12.1	Sound Settings for Progr. via TV Menu	25
	12.1	Sound Settings for Prog. via the Stat. Table.	28
	13.	Colour Standard	29
	14.	Automatic Zoom.	30
	15.	Childlock	31
	16.	Reminder	33
	17.	Timer Control	34
	17.1	Setting the Time and Date	35
	17.2	Recording Control	36
	18.	Special Functions	
		- Picture-in-Picture	38
		- Normal/Speech.	39
		- Timer Overview	39
	- Direct Recording (OTR).	41	
	- Picture format	42	
	- Picture Position.	43	
18.1	Programming the Function Keys.	44	
19.	Sound Settings Mute Function	45	
20.	EPG	46	
20.1	Activating the EPG	47	
20.2	Collecting EPG Data	48	
20.3	Using the EPG	49	
20.3	Using the EPG Recording a Programme	52	
21.	Setting the Country and Language.	53	
Config.	22.	Setting Stations - Setting the reception mode	54
	22.1	TV-Standard ²⁾ for analogue stations.	55
	22.1	Analogue TV	56
	22.1	Colour standard for analogue stations	57
	22.2	Automatic DVB-T station search.	58

Contents

Configuration	22.2 Manual DVB-T station search	59
	22.3 Automatic DVB-C station search	60
	22.3 Manual DVB-C station search	61
	23. Station Logo.	62
	24. Sorting Stations	63
	25. Reg. AV Devices.	64
	- Data Logic.	65
	- Setting the signal types RGB	67
	- Setting the signal types DVI / HDMI.	68
	- Setting the signal types YUV (HD)	69
25.1 Removing AV Devices	70	
26. Initial Programme Position.	71	
27. Sound via HiFi Amplifier HiFi output	72	
28. Display Configuration.	74	
29. DVB Radio Mode	75	
30. Scope of Operation	76	
31. Operation without the Remote Control	78	
32. Connecting Headphones.	78	
33. Sound 1, Sound 2	79	
34. Cleaning the TV Set	79	
35. Connections on the Front	80	
35.1 Connections on the Rear of the Set.	81	
36. Copying between AV Devices		
Direct recording	84	
37. Setting the Picture Format	86	
38. Glossary	87	
39. Technical Data	90	
39.1 Upgrade Kits	92	
40. Inserting/Removing CA Modules	93	
41. Basic differences between		
analog terrestrial reception and DVB-T.	94	
Appendix for DVB satellite reception		
(applicable only if a satellite tuner is installed)		
A1. Setting up the Satellite Antenna System,		
LNB Supply Voltage	96	
A1.1 Setting up the Satellite Antenna System,		
DiSEqC System	97	
A1.2 Setting up the Satellite Antenna System,		
Selecting Satellites	98	
A.2 Setting Stations, Search Settings	99	
Setting Stations, Automatic Search.	100	
Setting Stations, Manual Search	101	
Setting Stations, Updating the Data	102	
Problems, Possible Causes, Remedies.	103	
Index.	105	
Connect a PC.	108	
Worth knowing		

1. Installation

- Take care that no bright artificial light or sunshine falls directly on the screen. This could cause reflections which have a negative effect on the brilliance of the picture.
- The best viewing distance is five times the screen diagonal, i.e.
 - Approximately 3.3 m (11 ft) for 26" screens
 - Approximately 4 m (13 ft) for 32" screens
 - Approximately 4.7 m (15 ft) for 37" screens
- The antenna cable and any other components (such as a video recorder) connected between the antenna socket in the wall and the TV set must comply with the European standard EN 60966-2-4.
- The antenna cable used for connecting the TV set must have a screening attenuation of at least 75 dB.
- The use of non-approved cables will invalidate the operating permission for the TV set.
- For details of how to connect peripheral devices such as video recorders, DVD players, etc. press the „INFO“ key to call the help function, select „Connecting AV devices“ with the cursor and press „OK“ to display the information.
- Only use Metz bases as a stand for the LCD TV.
- Use the Metz wall bracket (item no. 604 99 0286.A1) or a suitable OmniMount wall bracket to hang the LCD TV on the wall. For an OmniMount wall bracket, you also need the Metz adapter plate 013ZM1091.

2. Safety notes

- Always place the monitor on a solid, stable surface.
- If a cold TV set is moved to a warm room, always allow any condensation on the screen to evaporate before switching it on.
- The TV set is intended for use in a dry room. If, in exceptional circumstances, you use it outdoors, take care that it is protected against moisture (rain, splashed water, dew).
- TV sets need adequate ventilation. Never cover the openings on the rear of the set with curtains, doilies, newspapers, etc. Also take care that the slits in the bottom of the case are freely accessible so that the intake of the cooling air is not hindered.
- If you place the TV set in a wall unit, leave sufficient space on all sides for the circulation of cooling air.
- Do not place the TV set close to a radiator, since this would effect adequate cooling.
- Do not place
 - burning candles or
 - vessels containing liquids (vases, etc.)on top of the TV set, since any hot wax or water dripping into the set could cause serious damage to the electronic components and could also jeopardize the electrical safety of the set.
- Lightning can damage electrical equipment. A lightning flash entering the power cable or the aerial cable can damage the TV set even if it is switched off. You should therefore disconnect the power cable and aerial cable

from their outlets or from the TV set in the case of a thunderstorm.

- The monitor may be opened and repaired only by a qualified person.

CAUTION! HIGH VOLTAGES CAN KILL !

If repairs should be necessary, consult your local dealer.

- Always switch off the TV set before cleaning it.
- Do not hold the remote control directly in front of your eyes and press a button. The remote control emits infrared radiation!
- Do not place rechargeable batteries in the battery compartment of the remote control. Use only two 1.5 V dry batteries of the type LR03/AM4/AAA (Micro).
- The TV set is intended only for the reception and reproduction of picture and sound signals.
- The TV set may be operated only from a mains voltage of 230-240V VAC, 50 Hz. Australia: 240 VAC.
- For maintenance and repair work, the power plug or the power-cord input of the TV represents a means to disconnect the device from the mains and must therefore be kept in a usable state in line with applicable standards.
- Lay the power cable so that nothing stands on it and no-one can trip over it.
- Do not display still images, logos, 4:3 pictures with stripes etc. over an extended period. These still images can result in marks on the screen.

3. The Remote Control

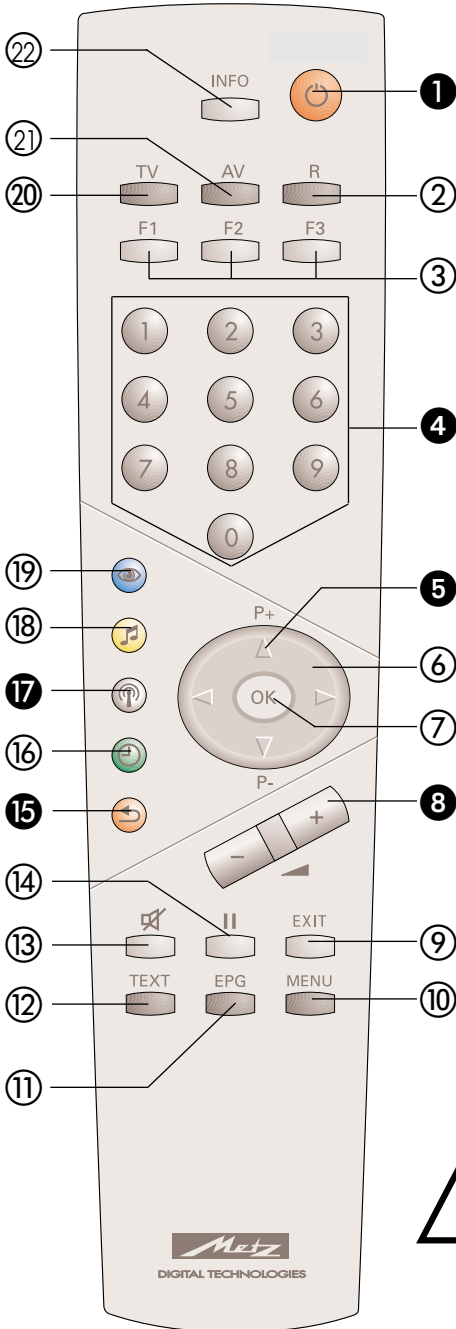

The remote control sends commands to the TV set by means of an infrared signal. You must point it towards the TV set when using it. Note that the remote control may interfere with the operation of other devices which use infrared signals (such as infrared headphones).

Sunlight falling directly on the TV set may interfere with the operation of the remote control, since the TV set cannot detect the infrared signals from the remote control under these conditions. The TV set must be switched on with the main power switch before it can be controlled with the remote control.

The most important keys for normal use

- 1 ON**
Switches the TV set on with programme position 1 or the programmed initial programme position selected, or switches it OFF (to the standby state).
- 4** Numeric keys (direct station selection).
- 5 P+ /P-** Selects the next/previous programme position.
- 8** Volume control.
Setting can be changed in the menu.
- 15** Back to the previously selected station.
- 17** Displays the station table.



Do not insert rechargeable batteries in the battery compartment of the remote control.

Use only two dry batteries of the type LR03/ AM4/AAA 1.5V.

3. The Remote Control

Overview of the functions of the keys

- ② Switch to DVB radio mode.
Switch on from the standby state into radio mode¹⁾.
- ③ Function keys:
F1/F2/F3: **press briefly** to call the functions set in the factory.
F1/F2/F3: **press and hold** to display a selection of special functions.
AV: press to select one of the previously configured AV devices.
- ⑥ Cursor control key in the "Information" window and the "TV menu".
- ⑦ OK: confirmation key.
- ⑧ Volume control; values can be set in the TV menu.
- ⑨ Exit key: exit from the menu without saving any changes you have made.
- ⑩ Open the TV menu.
In the menu: back to the main menu.
- ⑪ Open the electronic programme guide (EPG).
- ⑫ Open the Teletext window.
- ⑬ Mute.
- ⑭ Freeze frame.
- ⑮ Back to the previously selected station.
In the TV menu: open the "Configuration" menu.
- ⑯ Display the date and time.
In the TV menu: open the "Timer" window.
- ⑰ Display the station table.
In the TV menu: open the station table or the station features window.
- ⑱ Display the sound functions.
In the TV menu: open the "AV devices" window.
- ⑲ Display the picture functions.
In the TV menu: open the "picture and sound" window.
- ⑳ Back to the TV picture.
Switch from radio mode¹⁾ to TV mode.
Switch on from standby mode into TV mode.
- ㉑ Display the AV menu "Replay/record".
Switch on from standby mode into AV mode.
- ㉒ Display the "Information" window. In the "Information" window:
back to the table of contents.

1) Possible only in DVB mode !

4. Daily Operation

Switching on

Switch on the TV set with the main switch.

The TV set is now in standby mode and the red standby indicator lights.

After about five seconds, the TV set switches to programme position 1 or to the programmed initial programme position.

If you press no further keys on the remote control, a window requesting that you do so is displayed after about 10 minutes. If you do not do this, the TV set switches back to the standby state.

Use the numeric keys to select any desired programme position. Pressing the  key selects programme position 1 or, if it is programmed, the initial programme position (see page 71).



Switching off

Press the  key to switch the TV set to standby mode. If you do not intend to use the TV set for a longer period, switch it off with the main power switch.

Adjusting the volume

The volume can be adjusted with the - + key.

Adjusting the picture and sound settings

Call the picture settings with the blue key  or the sound settings with the yellow key . The setting box with the various functions is then displayed at the bottom left of the screen. Use the rocker key "P+/P-" to select the desired function and then use the - + key to adjust the setting.

5. Selecting the Operating Mode

You can switch the TV set between its various operating modes with the keys "TV", "AV" and "R". You can also switch from standby mode to the desired operating mode with these keys.

If you switch on the TV set with one of these keys, the station in the operating mode selected before the TV set was switched off is again selected.

TV = TV mode

AV = TV mode with input from AV devices (e.g. video tape recorder, DVD player, etc.)

R = DVB Radio mode ¹⁾



1) Possible only in DVB mode !

6. Station Selection

Station selection and management of programme positions

The TV set can store the settings for up to 2000 TV stations and 2000 radio stations in so-called programme positions. You can select any of these programme positions with the numeric keys, with the oval rocker key "P+/P-" or from the station table.

If you use the numeric keys for station selection, the first digit you enter is nor-

mally the "thousands" digit. If less than 1000 programme positions are occupied, it automatically becomes the "hundreds" digit.

If less than ten programme positions are occupied, the first digit you enter automatically becomes the "units" digit.

After pressing any numeric key, you have three seconds to press further numeric keys

6. Programmwahl



Opening the menu

Selecting stations from the station table

In normal TV or radio ¹⁾ mode, you can display the station table by pressing the white  key.

Press the white key  repeatedly to display a virtual keyboard. Use the respective key to sort the station list alphanumerically.

In the table which is then displayed, you can use the oval rocker key "P+/P-" or the numeric keys to select the desired station and then press the "OK" key to display this station.

If the station table contains more than 20 stations, you can display the next 10 stations by pressing the oval cursor control key  .





Back to the last station

You can use the red  key to switch back and forth between the last two stations you have selected.

10	Kabel 1
9	Nord 3
8	RTL
7	PRO 7
6	Nord 3
5	PRO 7
4	SAT1
3	Bayern 3
2	ZDF
1	ARD
56	Hessen 3
55	SW-BW
54	N-TV
53	West 3
52	Phoenix

1	CHI	2	TUV	3	WXYZ
2	ABC	3	DEF	4	GHI
3	JKL	4	MNO	5	PQRS

Pr Select with ...
or  
Confirm with .



1) Possible only in DVB mode !

During the design of this TV set, we have made every effort to make it as easy as possible for you to use it and we hope that you will enjoy familiarising yourself with your new TV set.

With the "Information" menu, the TV set is able to answer the many questions which may come up during installation and setup.

To display this menu, simply press the "INFO" key for the table of contents.

INFO



The "Information" menu (user help)

In the table of contents or the index, you can select the item of interest with the cursor control key.

Use the cursor-right key ► to scroll forwards through the contents or index ...

Use the cursor-left key ◀ to scroll backwards through the contents or index ...

Use the cursor-up key ▲ to select the last underlined item ...

Use the cursor-down key ▼ to select the menu lines...

... and then press the "OK" key to display the explanation of the selected item.

You can select any underlined word in the table of contents, the index or the explanation of a selected item with the cursor. Pressing the "OK" key then displays the explanation for this word.

You can also scroll forwards and backwards through previously displayed pages with the aid of the red and green keys.

Information Contents

Index

Station selection

Picture settings

Sound settings

AV playback

Recording facilities:

- Timer recording

- Direct recording

- AV copying

Teletext

Function keys

DVB radio mode

Electronic Programm Guide (EPG)

Select the underlined text with the cursor.

ⓘ : further information INFO : table of contents

Visited pages: ● back ● forward

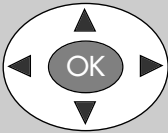

8. Menu Control

Opening the menu

With the "TV menu", we provide you with an assistant to help you find your way through the many possible settings of the TV set.

Don't be afraid to change any settings in the various menus. No changes will be saved unless you press the "OK" key to confirm them. If you are not sure whether you want to keep a changed setting, you can exit from the menu at any time, without saving any changes, by pressing the "EXIT" key.

Within the TV menu, you can return to the previous main menu item at any time by pressing the "MENU" key. If you are not sure what a menu item does, press the "INFO" key for more information.

In order to return to the menu, press the "INFO" key twice.

You can open each of the five main sections of the menu with the key of the corresponding colour. The "card file" which is then displayed is subdivided into Subjects (on the left) and Sections (on the right), and you can select these by moving the red, triangular cursor with the oval cursor control key or with the numeric keys.

When you press the "OK" key, the current setting for the selected item is shown in the "Setting window" below the card file and can be adjusted with the - + key.

You can save the new setting by pressing the "OK" key, which also returns you to the list of sections. If you do not want to save the new setting, press the "MENU" key to return to the corresponding main menu item or press the "EXIT" key to close the menu.

You can delete any incorrect inputs with the II key.

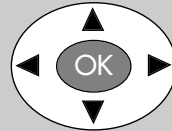
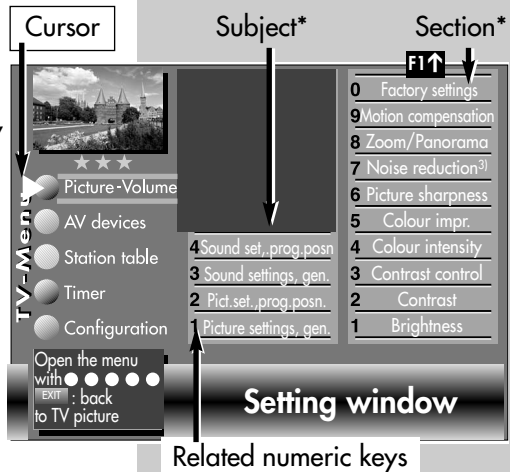

* The number of subjects and sections depends on the selected scope of operation. Depending on the configuration of the TV set, the various menu items may be displayed in a different order and numbered differently.

Opening the menu

TEXT

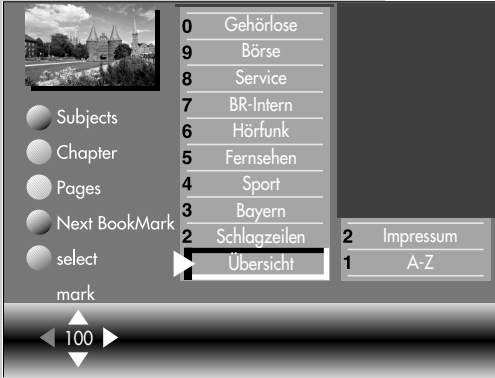

9. Teletext

Teletext is an additional service provided free of charge by many TV stations. It is an "electronic magazine" through which you can browse in various ways.

Opening Teletext:

- Press the "TEXT" key. If the selected station offers "TOP-Text", a "card file" is displayed (see the picture on the left). If "TOP-Text" is not available, Teletext page 100 is displayed (see the picture below).
- In the TOP-Text card file, you can select the desired cards with the cursor control key or with the numeric keys.
- Press the "OK" key to open the selected card.

Controlling Teletext with pages displayed:

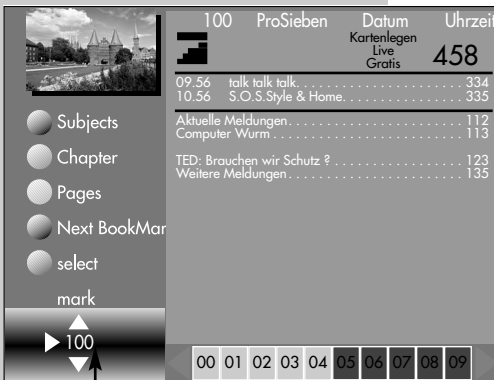

Blue key – next subject.

Yellow key – next section.

White key – next page.

After pressing the coloured pre-selection key, you can step through the subjects, sections or pages with the cursor control key or with the numeric keys.

If you wish to select a specific page, enter its page number on the numeric keys.

Page number

Sub-pages

If sub-pages exist for the selected page, the page numbers are displayed in black. In the example shown here, there are five sub-pages.

You can step through these sub-pages with the cursor control key.

9. Teletext

Double font size

You can double the size of the font used for Teletext pages with the **F1** key. Pressing this key once displays an enlarged picture of the upper third of the page. Pressing it a second and third time displays the centre and lower thirds of the page. Pressing a fourth time displays the entire page again.

Riddle key (display hidden text)

Function key **F2** is programmed in the factory to display hidden text, such as the answers to riddles.

Back to the last index page

You can return directly to the last index page you have displayed by pressing the numeric key **0**.

Stop page scrolling

The **II** key or the "OK" key can be used to stop the automatic scrolling executed by some pages, and to enable this again.

Page selection with the cursor

Press the "OK" key to stop page scrolling. The cursor **▶** is now positioned at the top left corner of the page and you can use the cursor control key **◀▶▲▼** to position it anywhere on the displayed page. This function is useful on index pages (such as pages 100, 200, etc.) in order to select a page you want to see. After positioning the cursor on the desired page number, press the "OK" key to display its contents.

Setting marks in Teletext ⁶⁾

As a user of Teletext, you will probably want to visit certain pages (such as stock-market news, news pages or the weather forecast) regularly.

In order to find these pages quickly, you can set marks to suit your personal requirements.

To do this, open a page for which you want to set a mark.

- Press the red  key for "Set" to place a mark on this page. The number of the mark you have just set is displayed above the window containing the number of the Teletext page. In the case of multiple pages, the mark is always set and displayed for the currently displayed sub-page.

 *Up to 10 marks can be set for each programme position.*

Scrolling through marked Teletext pages ⁶⁾

With the Teletext window open, you can step sequentially through the marked pages with the green  key.

An even easier method is by pressing the "TEXT" key while the TV programme is displayed. Each time you press this key, the next marked page is displayed. After the last marked page, the TV picture is displayed again.

⁶⁾ Not possible with an external receiver !

9. Teletext

Displaying all Teletext marks ⁶⁾

If you have set marks for a programme position, you can display an overview of these marks by pressing the **F3** key. The displayed list shows where the marks are set. Press **F3** again to hide the list.

You can select the individual marks in the list with the numeric keys.

Clearing Teletext marks ⁶⁾

Open the Teletext page whose mark is to be deleted and press the red  key "Delete" to delete the mark.

Subtitles in Teletext

Your TV set is capable of displaying subtitles. When a programme for which subtitles exist starts, the TV station displays a box showing the Teletext page on which these can be found.

- Press the "**TEXT**" key to open Teletext.
- If this is a "TOP-Text" station, the card file is displayed. Press the "**OK**" key and open any available page.
- Use the numeric keys to enter the number of the page containing the subtitles.

⁶⁾ Not possible with an external receiver !

10. AV Playback

Opening the menu

AV playback (devices with switching voltage)

⚠ Before they can be used, AV devices must be registered and assigned to the appropriate input sockets in the menu "AV devices".

Playing back a recording from a video cassette, DVD, etc. on a connected AV device is called AV playback.

In order to see the picture, you must programme your TV set to execute an automatic programme change at the EURO socket to which the AV device is connected.

Programming a programme change

⚠ This menu item is not available in a 2 ** menu (see Section 30, Scope of Operation).

⚠ The automatic programme change is set in the factory to "ON" for all EURO sockets.

- Press the "MENU" key.
The TV menu appears on the screen.
- Press the red key . The menu "Configuration" is displayed.
- Use the corresponding numeric key (in this example: **7**) to select the menu item "EURO sockets".
- Use the cursor control key to select "EURO 1", "EURO 2" or "EURO 3".
- Press the "OK" key and then, in the setting window, use the - + key to select "Programme change on".
- Press the "OK" key to save the new setting.
- Press the "EXIT" key to close the TV menu.

If you now start to play back a recording on the connected AV device, the TV set changes automatically from any other programme position to the playback mode.

MENU

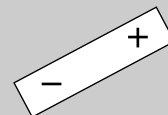
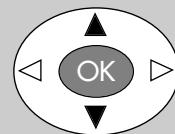
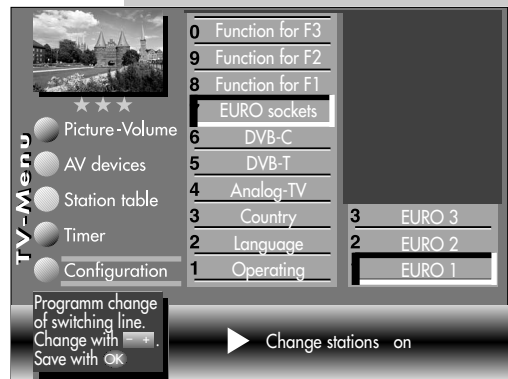

EXIT



The number of subjects and sections depends on the selected scope of operation. Depending on the configuration of the TV set, the various menu items may be displayed in a different order and numbered differently.

AV



AV playback

(devices without switching voltage)

 **Before they can be used, AV devices must be registered and assigned to the appropriate input sockets in the menu "AV devices".**

In order to see the played back picture, you must switch the TV set to playback mode.

- Select any programme position.
- Press the "AV" key.
- Use the corresponding numeric key to select the AV device you want to use.
- The TV set now changes from the current programme to the selected playback device.
- Start the replay function on the AV device. This AV selection remains active until you switch to any other programme position.
- After watching the film from the AV device, press the "TV" key to return to normal TV mode.

10.1 AV Playback VCR function

Opening the menu

 *The menu item "VCR" is not available in a 2 ** menu.*

Picture quality when playing back from tape devices

The VCR function ensures an optimum picture quality when playing back recordings from tape devices such as video cassette recorders or camcorders.

Setting the VCR function

- Select the appropriate AV level by pressing the "AV" key and using the numeric keys to select the AV device which is to supply the pictures.
- Press the "MENU" key to open the TV menu.
- Press the blue key . The menu "Picture and sound" and the menu item "General picture settings" are pre-selected.
- Use the corresponding numeric key (in the example: **2**) to select the menu item "Pict.settings for Pr."
- Use the corresponding numeric key (in the example: **8**) to select the menu item "VCR".
- Use the - + key to select "Opt.1". If this setting does not produce a satisfactory result, you can try using "Opt.2".
- Press the "OK" key to save the new setting.
- Press the "EXIT" key to close the TV menu.

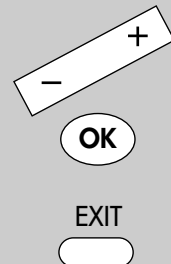
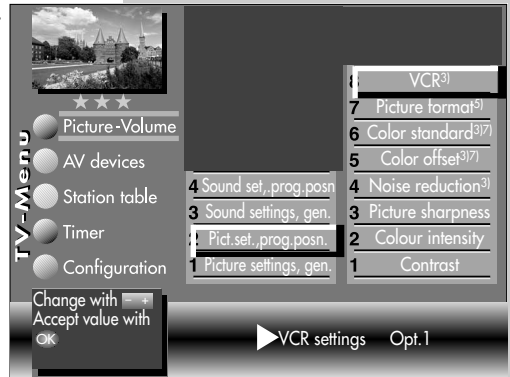
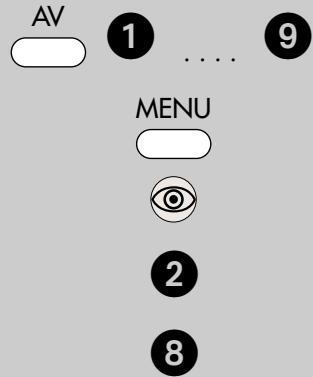

The number of subjects and sections depends on the selected scope of operation. Depending on the configuration of the TV set, the various menu items may be displayed in a different order and numbered differently.

5) Available only for DVB stations!

7) Available only for analogue stations!

Opening the menu

MENU

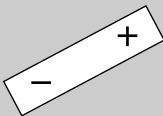
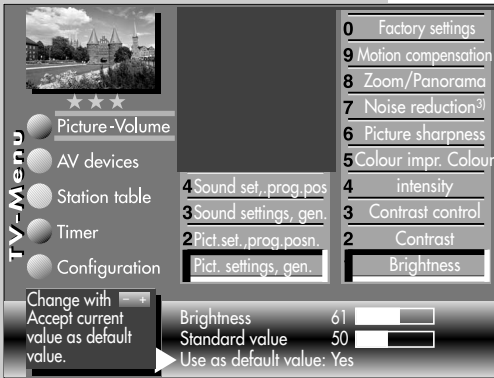

EXIT



The number of subjects and sections depends on the selected scope of operation. Depending on the configuration of the TV set, the various menu items may be displayed in a different order and numbered differently.

11. General Picture Settings

Some of the menu items are not available in a 2 ** menu.

The picture settings brightness, contrast, colour intensity, sharpness and noise reduction can be set generally for all programme positions and saved as **standard values** which can be recalled at any time by pressing the "OK" key.

Opening the picture settings menu:

This example describes how the brightness is adjusted. The other picture settings can be adjusted in a similar manner.

- Press the "MENU" key.
The TV menu appears on the screen.
- Press the blue key . The menu "Picture and sound" and the menu item "General picture settings" are pre-selected.
- Use the cursor control key to select the menu item "Brightness".
- The various menu items can be selected with the aid of the numeric keys.

- In the setting window, use the - + key to change the setting.
- Use the cursor control key to select the third line "Save as standard values".
- If you wish to save the new setting, use the - + key to select "Yes".
- Press the "OK" key to save the changed setting as a standard value.
- Press the "EXIT" key to close the TV menu.

If the standard values do not provide a satisfactory picture in some programme positions, you can make settings for these positions which differ from the standard values. See the next sections. 11.1 and 11.2.



11. General Picture Settings

Opening the menu

 **Some of the menu items are not available in a 2 ** menu.**

The picture settings zoom, vertical position, automatic zoom and panorama can be set and saved as general settings for all programme positions.

Setting the zoom/panorama mode:

- Press the "MENU" key.
The TV menu appears on the screen.
 - Press the blue key . The menu "Picture and sound" and the menu item "General picture settings" are pre-selected.
 - Use the cursor control key  to select the menu item "Brightness".
 - Press the corresponding **numeric key** to select "Zoom/Panorama".
 - Use the cursor control key to select the desired menu items.
 - Use the - + key to change the settings for "Zoom/Panorama".
 - Press the "OK" key to save the new settings.
The picture shows the factory settings.
 - Press the "EXIT" key to close the TV menu.
-  **The functions "Panorama" and "Zoom" can be combined with each other.**

MENU

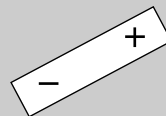
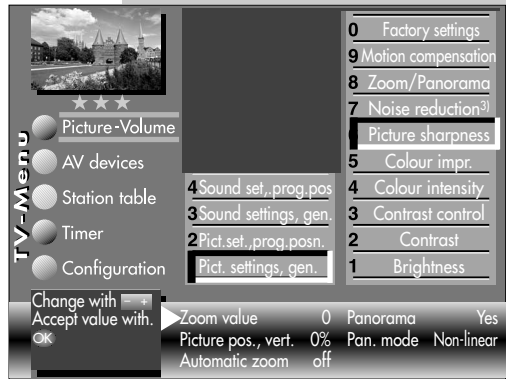

EXIT



The number of subjects and sections depends on the selected scope of operation. Depending on the configuration of the TV set, the various menu items may be displayed in a different order and numbered differently.

3) See glossary for an explanation.

Opening the menu

MENU

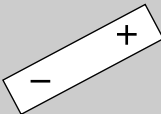
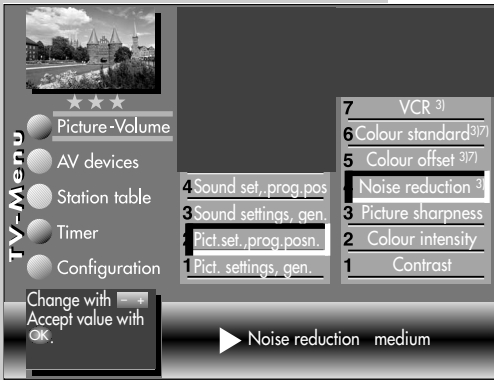

OK

EXIT



The number of subjects and sections depends on the selected scope of operation. Depending on the configuration of the TV set, the various menu items may be displayed in a different order and numbered differently.

2) Possible only on sets equipped with this function.

3) See glossary for an explanation.

5) Available only for DVB stations!

7) Available only for analogue stations!



11.1 Picture Settings for Programmes via TV Menu

 **Picture settings for individual programme positions are not available in a 2 ** menu.**

If the standard values do not provide a satisfactory picture in some programme positions, you can make different settings for these positions which override almost all of the general picture settings. These individual settings apply only to the programme position for which they are made, and they cannot be overwritten with the standard values. In addition to the general picture settings, the individual settings also include the settings colour offset, colour standard and VCR.

Individual picture settings for programme position xy:



- Select the programme position whose picture settings you wish to change.
- Press the "MENU" key.
The TV menu appears on the screen.

- Press the blue key . The menu "Picture and sound" and the menu item "General picture settings" are pre-selected.
- Use the cursor control key  to select the menu item "Pic. settings for Pr." And press the "OK" key.
- Use the corresponding numeric keys (in this example:  for noise reduction) to select the desired menu items.
- In the setting window, use the - + key to change the setting.
- Press the "OK" key to save the new setting.
- Press the "EXIT" key to close the TV menu.

11.2 Picture Settings for Programme via Station Table

Opening the menu

Individual picture settings for programme position xy:

- Select the programme position whose picture settings you wish to change.
- Press the "MENU" key.
The TV menu appears on the screen.
- Press the white key . The station table is displayed with the currently active programme position highlighted.
- Press the **F2** key to enable editing of the station table.
- Press the cursor control key  to move to the subject side.
- Use the corresponding numeric keys (in this example: **5** for the picture quality) to select the desired menu items.
- In the setting window, use the cursor control key to select the desired function.
- Use the - + key to change the setting. "gen." means here that the new setting will overwrite the related general picture setting (see pages 18 and 20).

 **The individual settings made here which differ from the general settings remain saved.**

- Press the "OK" key to save the new settings.
- Press the "EXIT" key to close the TV menu.

MENU



F2

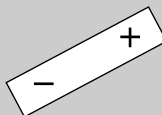
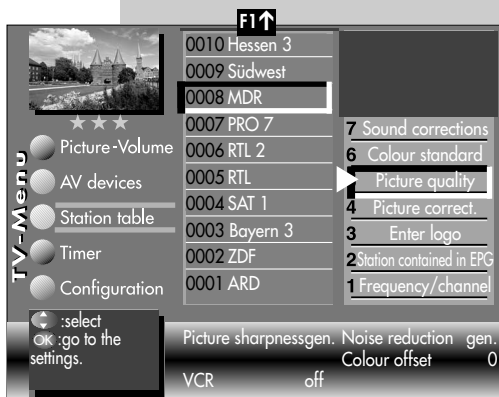

EXIT



Opening the menu

12. General Sound Settings

MENU



3

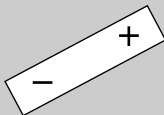
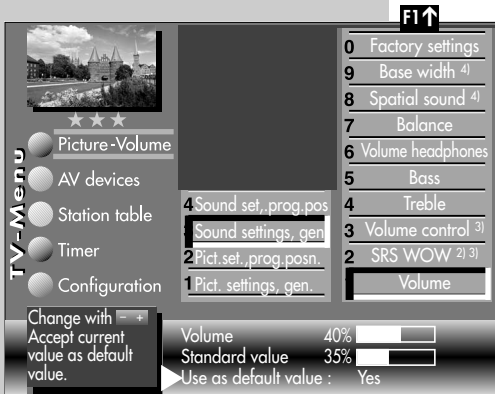

OK

EXIT



The number of subjects and sections depends on the selected scope of operation. Depending on the configuration of the TV set, the various menu items may be displayed in a different order and numbered differently.

- 2) Possible only on sets equipped with this function.
- 3) See glossary for an explanation.
- 4) Available only if SRS WOW is switched off

Some of the menu items are not available in a 2 ** menu.

The sound settings volume, treble, bass, stereo wide and spatial sound can be set generally for all programme positions and saved as standard values which can be recalled at any time by pressing the "OK" key.

Opening the sound settings menu:

- Press the "MENU" key.
The TV menu appears on the screen.
 - Press the blue key . The menu "Picture and sound" and the menu item "General picture settings" are pre-selected.
 - Use the corresponding numeric key (in the example: **3**) to select "General sound settings".
 - Use the corresponding numeric keys to select the desired menu items in the right-hand column.
 - Press the "OK" key to open the selected menu item for editing.
 - In the setting window, use the - + key to change the setting.
 - Use the cursor control key ▼ to select the third line "Save as standard value".
 - If you wish to save the new setting, use the - + key to select "Yes".
 - Press the "OK" key to save the new settings as standard values.
 - Press the "EXIT" key to close the TV menu.
- If the standard values do not provide satisfactory results for some programme positions, you can make different individual settings for these positions. See sections 12.1.**

12. General Sound Settings

Opening the menu

 **Some of the menu items are not available in a 2 ** menu.**

Setting SRS-WOW²⁾

- Press the "MENU" key.

The TV menu appears on the screen.

- Press the blue key . The menu "Picture and sound" and the menu item "General picture settings" are pre-selected.
- Press the numeric key **3** to select "General sound settings".
- Use the corresponding numeric key (in the example: **2**) to select "SRS-WOW"²⁾.
- In the setting window, use the - + key to change the setting.
- Press the "OK" key to save the changed setting.
- „Press the "EXIT" key to close the TV menu.

 **If the SRS-WOW function is active, the menu items "stereo wide" and "spatial sound" are disabled.**

MENU



3

2

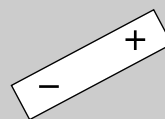
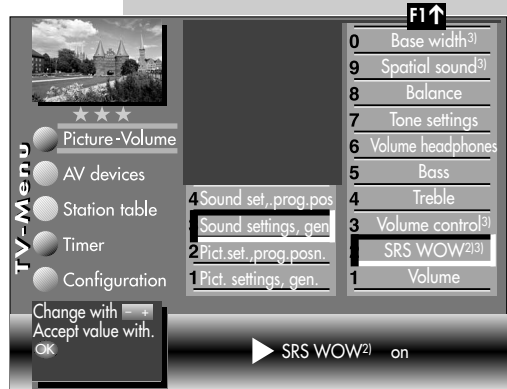

EXIT



The number of subjects and sections depends on the selected scope of operation. Depending on the configuration of the TV set, the various menu items may be displayed in a different order and numbered differently.

2) Possible only on sets equipped with this function.

3) See glossary for an explanation.

4) Available only if SRS WOW is switched off

Opening the menu

MENU



3

3

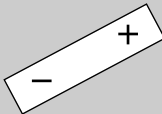
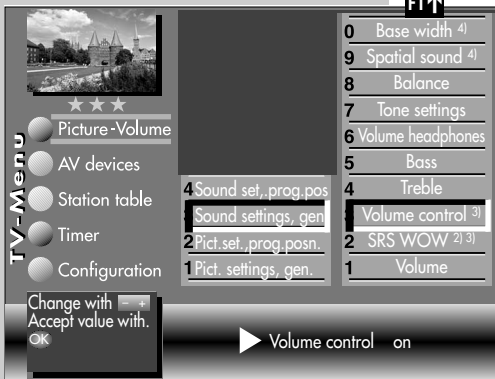

OK

EXIT



The number of subjects and sections depends on the selected scope of operation. Depending on the configuration of the TV set, the various menu items may be displayed in a different order and numbered differently.

2) Possible only on sets equipped with this function.

3) See glossary for an explanation.

4) Available only if SRS WOW is switched off

12. General Sound Settings

Automatic volume correction

Some TV stations transmit their commercials at a higher sound volume than that for the normal programme. In order to save you from adjusting the volume each time with the remote control, you can activate automatic volume correction.

With this function active, there is little difference in the volume levels for the normal programme and the commercials.

The setting made here applies to all programme positions.

Opening the volume correction menu:

- Press the "MENU" key.
The TV menu appears on the screen.
- Press the blue key . The menu "Picture and sound" and the menu item "General picture settings" are pre-selected.
- Use the corresponding numeric key (in the example: **3**) to select "General sound settings".

- Use the corresponding numeric key (in the example: **3**) to select "Volume correction".
- In the setting window, use the - + key to change the setting.
- Press the "OK" key to save the new setting.
- Press the "EXIT" key to close the TV menu.

The function "Volume correction" in the menu "General sound settings" does not overwrite the function "Volume correction" in the menu "Sound settings for Pr..."

12.1 Sound Settings for Programmes via TV Menu

Opening the menu

 *Some of the menu items are not available in a 2 ** menu.*



Volume correction

Various TV stations broadcast their programmes with different sound volumes. This volume difference can be minimised by correcting the volume. This adjustment remains active even if the standard sound values are recalled.

Adjusting the volume correction:

- Press the "MENU" key.
The TV menu appears on the screen.
- Press the blue key . The menu "Picture and sound" and the menu item "General picture settings" are pre-selected.
- Use the corresponding numeric key (in the example: **4**) to select "Sound settings for Pr.".
- Press the "OK" key and then, in the setting widow, use the - + key to change the setting.
- Press the "OK" key to save the new settings.
- Press the "EXIT" key to close the TV menu.

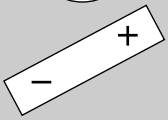
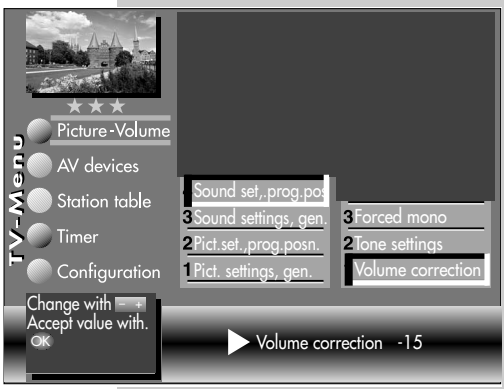

EXIT



 *Individual sound settings can also be made in the station table.*

The number of subjects and sections depends on the selected scope of operation. Depending on the configuration of the TV set, the various menu items may be displayed in a different order and numbered differently.

Opening the menu

MENU



4

2

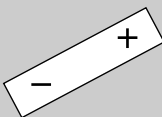
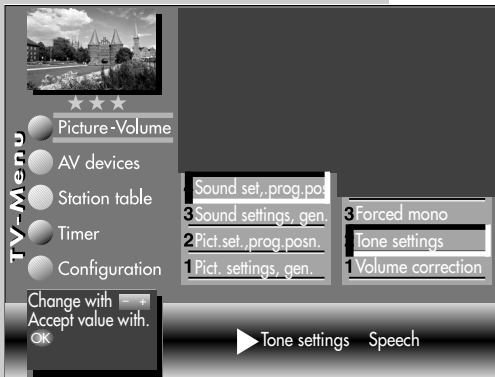

OK

EXIT



12.1 Sound Settings for Programmes via TV Menu

*Some of the menu items are not available in a 2 ** menu.*

Tone setting

The tone setting can be set to "Normal" or "Speech". The setting "Speech" should be used primarily for stations which broadcast mainly programmes with a lot of speech, such as news stations. The setting "Normal" is better for music programmes.

Adjusting the tone setting :

- Press the "MENU" key.
The TV menu appears on the screen.
- Press the blue key . The menu "Picture and sound" and the menu item "General picture settings" are pre-selected.
- Use the corresponding numeric key (in the example: 4) to select "Sound settings for Pr."

- Use the corresponding numeric key (in the example: 2) to select "Tone settings".
- In the setting window, use the - + key to change the setting.
- Press the "OK" key to save the new settings.
- Press the "EXIT" key to close the TV menu.

Individual sound settings can also be made in the station table.

The number of subjects and sections depends on the selected scope of operation. Depending on the configuration of the TV set, the various menu items may be displayed in a different order and numbered differently.

12.1 Sound Settings for Programmes via TV Menu



Opening the menu

 *Some of the menu items are not available in a 2 ** menu.*

Forced mono

It may happen that your TV set switches from mono to stereo in the middle of a programme, although no stereo sound is being transmitted. This is generally caused by the local reception conditions. If you activate "Forced mono" for the selected programme position, all programmes from this station will be reproduced in mono.

Activating forced mono:

- Press the "MENU" key.
The TV menu appears on the screen.
 - Press the blue key . The menu "Picture and sound" and the menu item "General picture settings" are pre-selected.
 - Use the corresponding numeric key (in the example: **4**) to select "Sound settings for Pr.".
 - Use the corresponding numeric key (in the example: **3**) to select "Forced mono".
 - In the setting window, use the - + key to change the setting.
 - Press the "OK" key to save the new settings.
 - Press the "EXIT" key to close the TV menu.
-  *Individual sound settings can also be made in the station table.*

MENU



4

3

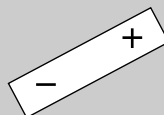
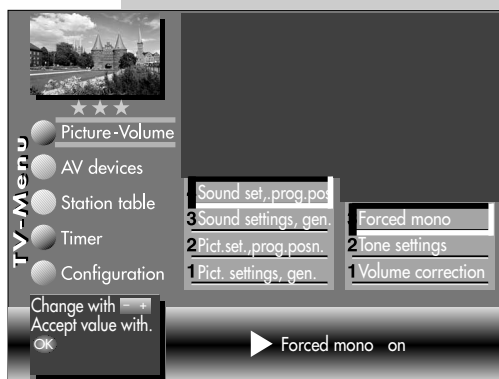

EXIT



The number of subjects and sections depends on the selected scope of operation. Depending on the configuration of the TV set, the various menu items may be displayed in a different order and numbered differently.

Opening the menu

MENU



F2



7

12.2 Sound Settings for Prog. via the Station Table

*Some of the menu items are not available in a 2 ** menu.*

Making sound corrections:

- Select the programme position whose sound settings you wish to change.
- Press the "MENU" key.
The TV menu appears on the screen.
- Press the white key . The station table is displayed with the currently active programme position highlighted.

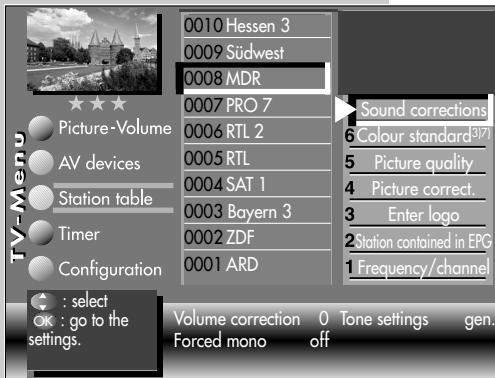

- Press the F2 key to enable editing of the station table.
- Use the cursor control key to move to the subjects side.
- Use the corresponding numeric keys (in this example:) for sound corrections) to select the desired menu items.
- In the setting window, use the cursor control key to select the desired functions.

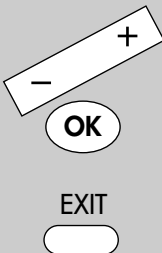

The number of subjects and sections depends on the selected scope of operation. Depending on the configuration of the TV set, the various menu items may be displayed in a different order and numbered differently.

- 3) See glossary for an explanation.
- 5) Available only for DVB stations!
- 7) Available only for analogue stations!

The use of the - + key to change the selected setting. "gen." means here that the new setting will overwrite the **general** sound settings (see pages 24 and 26).

The individual settings made here, which differ from the standard values, remain saved.

Press the "OK" key to save the new settings.

Press the "EXIT" key to close the TV menu.

13. Colour Standard



Opening the menu

 **Some of the menu items are not available in a 2 ** menu.**

Normally, your TV set will automatically detect the colour standard (PAL, SECAM, NTSC, NTSC44, PAL60, PALM or Pal N) transmitted by each station. If this does not function correctly for some programme positions, you can select the colour standard manually.

The factory setting for the colour standard is "Automatic".

Setting the colour standard:

- Select the programme position for which you wish to select the colour standard.
- Press the "MENU" key.
The TV menu appears on the screen.
- Press the white key . The station table is displayed with the currently active programme position highlighted.
- Press the F2 key to enable editing of the station table.
- Press the cursor control key  to move to the subjects side.
- Use the corresponding numeric key (in the example: ) to select "Colour standard".
- In the setting window, use the - + key to change the setting.
- Press the "OK" key to save the new setting.
- Press the "EXIT" key to close the TV menu.

MENU



F2



6

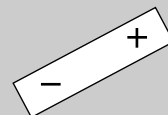
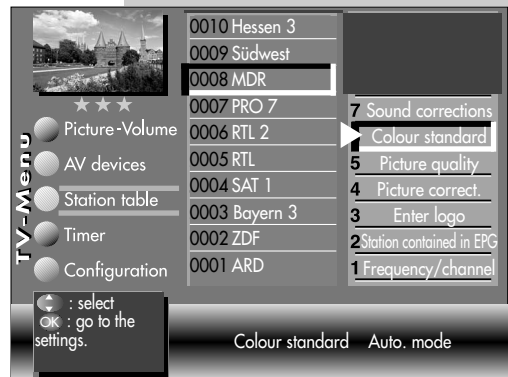

OK

EXIT



The number of subjects and sections depends on the selected scope of operation. Depending on the configuration of the TV set, the various menu items may be displayed in a different order and numbered differently.

3) See glossary for an explanation.

5) Available only for DVB stations!

7) Available only for analogue stations!

Opening the menu

MENU



6

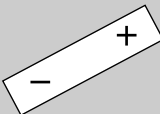
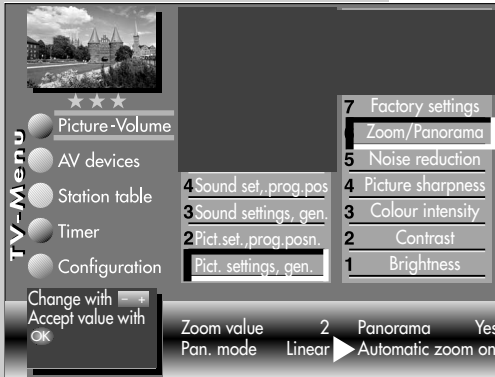

OK

EXIT



The number of subjects and sections depends on the selected scope of operation. Depending on the configuration of the TV set, the various menu items may be displayed in a different order and numbered differently.

14. Automatic Zoom

The menu item "Automatic zoom" is not available in a 2 ** menu.

When the automatic zoom function is active, programmes in a "widescreen" format (such as programmes in 16:9) are expanded to fill as much of the screen as possible.

If the function is inactive, the programmes are displayed in their original format.

Activating the automatic zoom 2)

- Press the "MENU" key. The TV menu appears on the screen.
- Press the blue key . The menu "Picture and sound" and the menu item "General picture settings" are pre-selected.
- Use the cursor control key to select the menu item "Brightness".
- Use the corresponding numeric key (in the example: **6**) to select the function "Zoom/Panorama".
- Use the cursor control key to select the menu item "Automatic zoom".

- Use the - + key to change the setting.
- Press the "OK" key to save the new setting.
- Press the "EXIT" key to close the TV menu.

15. Childlock



Opening the menu

With the aid of the childlock function, you can determine whether or not the TV set can be switched on and which stations may be selected at which times. The childlock can be set such that:

- a) it is always active,
- b) one to six TV, radio or AV programmes (Prog A ... Prog F) are exempted from the locking function (permitted programmes), or
- c) all programmes, or programmes which are not locked, may be viewed during a permitted time period (TV start – TV end).

The childlock must be saved once with a 4-digit "code" (password).

a) Activating the childlock

- Press the "MENU" key.
The TV menu appears on the screen.
- Press the green key  to open the menu "Timer".
- Use the cursor control key  to select "Settings" and press the "OK" key.
- In the setting window, use the cursor control key to select the menu item "Activate" and then use the - + key to set the childlock to "Active".
- Use the cursor control key  to select "Code" and enter your personal 4-digit code with the numeric keys.
Make a note of this code!
- Press the "OK" key to save the new setting.
- Press the "EXIT" key to close the TV menu.

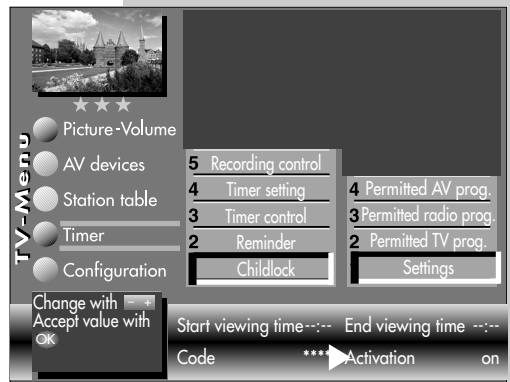
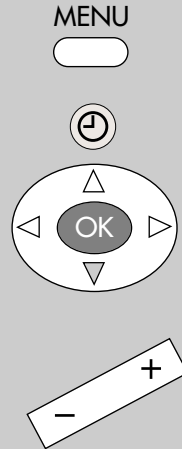

The number of subjects and sections depends on the selected scope of operation. Depending on the configuration of the TV set, the various menu items may be displayed in a different order and numbered differently.

b) Permitted programmes:

Activate the childlock as described in step a).

Use the corresponding numeric key to select the menu item "Permitted xx progs." (xx = TV, radio or AV). Press the "OK" key and, in the setting window, enter the programme positions with the numeric keys or use the - + key to select the desired programme positions.

- Press the "OK" key to save the new settings.

c) TV start – TV end

Activate the childlock as described in step a). In the setting window, use the cursor control key to select the start and end times and enter the desired times with the numeric keys. Press the "OK" key to save the settings.

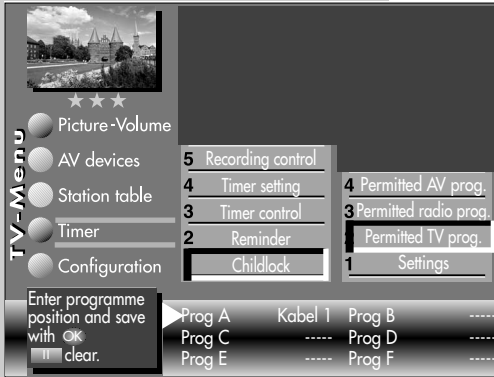

Protecting the childlock settings with your code

- Use the cursor control key to select "Code" and enter your personal code (password) with the numeric keys.



⚠ Make a note of this code, since the child lock can be deactivated only if the correct code is entered !

- Press the "OK" key to save the settings.
- Press the "EXIT" key to close the TV menu.
- Switch off the TV set with the ⏻ key.

⚠ The childlock is not fully activated until the TV set is switched off.

Deactivating the childlock

If the childlock is active, a window requesting your personal code is displayed each time the TV set is switched on. Entering the correct code enables the TV set and it can then be used normally until it is switched off again. To cancel the childlock function, proceed as described in step a), above, and set the childlock to "Inactive".



Factory setting
Code: 0000

16. Reminder

Opening the menu

 **The menu item "Reminder" is not available in a 2 ** menu.**

If you wish to be reminded of something while watching TV, you can set a reminder for any desired time. At this time, a window with the reminder appears on the screen.

Setting the reminder time

- Press the "MENU" key to open the TV menu.
- Press the green key  to open the "Timer" menu.
- Press the numeric key **2** to select "Reminder".
- Press the "OK" key and then, in the setting window, enter the desired time (four digits) with the **numeric keys**.
- Press the "OK" key to save this setting.
- Press the "EXIT" key to close the TV menu.

At the programmed time, a window with the reminder is displayed on the screen. You can close this window by pressing any key on the remote control.

 **If you do not want the reminder to appear every day, you must clear the time in the menu by pressing the **||** key.**

MENU



2

OK

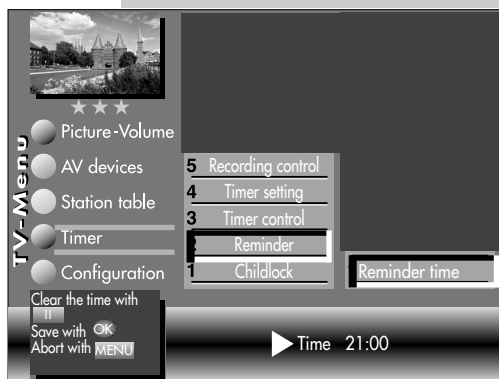

OK

EXIT



The number of subjects and sections depends on the selected scope of operation. Depending on the configuration of the TV set, the various menu items may be displayed in a different order and numbered differently.

Opening the menu

17. Timer Control

MENU



OK

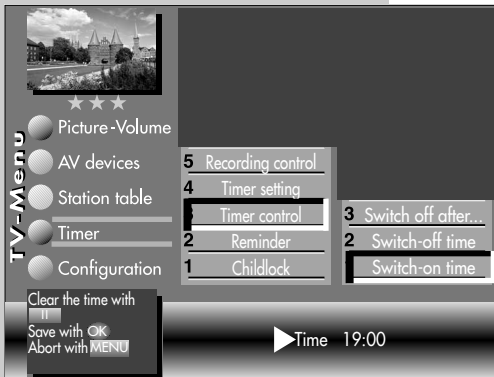

OK

EXIT



The number of subjects and sections depends on the selected scope of operation. Depending on the configuration of the TV set, the various menu items may be displayed in a different order and numbered differently.

The menu items "On time" and "Off time" are not available in a 2 ** menu.

In the menu item "Timer control", you can programme a switch-on time, a switch-off time and a sleep timer (switch off after ...).

The **switch-on time** is the time at which the TV set is to be switched on automatically.

The **switch-off time** is the time at which the TV set is to be switched off automatically.

The **sleep timer** (switch off after...) switches off the TV set after a programmed delay (which can be set in steps of 15 minutes).

Setting the on time and off time

- Press the "MENU" key to open the TV menu.
- Press the green key to open the "Timer" menu.
- Press the numeric key to select "Timer control".
- Press the "OK" key and then, in the setting window, enter the desired time (four digits) with the numeric keys.

- Press the "OK" key to save the setting.
- Press the "EXIT" key to close the TV menu.

At the programmed on time, the TV set is switched on from the standby state (red LED lights). You must confirm this automatic action by pressing any key on the remote control. If this is not done, the TV set will switch back to the standby state after 10 minutes. This ensures that the TV set does not stay on if you are not at home.

If you do not want to have the TV set switch itself on each day, you must clear the on and off times in the menu by pressing the II key.

17.1 Setting the Time and Date

Opening the menu

Normally, the TV set will determine the current date and time from the Teletext signals of the currently selected station (providing this station sends Teletext).

If this is not the case, or if an incorrect date or time is displayed, you can set the date and time manually.

In almost all cases, you will not need to do this. Even the changeover between winter time and summer time is executed automatically.

Setting the time and date manually:

- Press the "MENU" key to open the TV menu.
- Press the green key  to open the "Timer" menu.
- Press the numeric key **4** to select "Time settings".
- Press the "OK" key and then, in the setting window, enter the current time with the numeric keys.
- You can then start the internal clock precisely by pressing the "OK" key when the time you have entered is reached.

- Press the numeric key **2** to select "Current date".
- In the setting window, enter the date with the numeric keys.
- Press the "OK" key to save the settings.
- Press the "EXIT" key to close the TV menu.

i The local time offset is the difference between the local time where the TV set is installed and Greenwich Mean Time (GMT). The TV set normally detects this time offset and also the additional changeover to summer time.

The time needs to be set manually only if it is not detected automatically.

MENU



4

OK

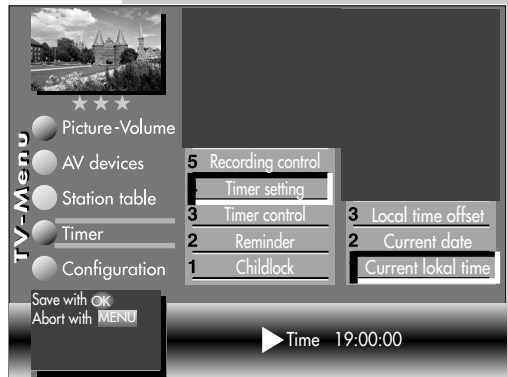

OK

2

OK

EXIT



The number of subjects and sections depends on the selected scope of operation. Depending on the configuration of the TV set, the various menu items may be displayed in a different order and numbered differently.

Opening the menu

MENU



5



OK

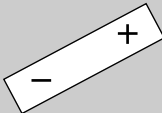
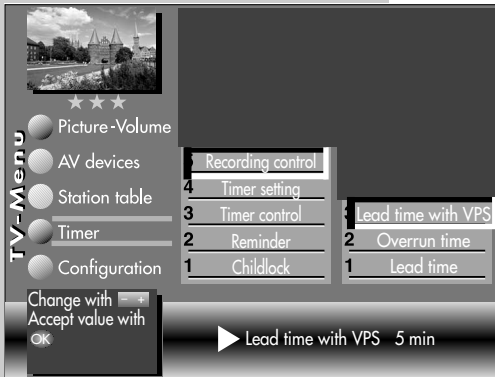

OK

EXIT



The number of subjects and sections depends on the selected scope of operation. Depending on the configuration of the TV set, the various menu items may be displayed in a different order and numbered differently.

17.2 Recording Control

This menu item is not available in a 2 ** menu.

In the menu item "Recording control", you can set a lead time and an overrun time for timer recordings. The TV set is automatically switched to the programme position from which the recording is to be made at a time which is the number of minutes programmed as the **lead time** before the programmed starting time for the recording.

At the end of the programmed recording time, the TV set remains set to this programme position for the period programmed as the **overrun time**.

For **VPS** recordings, the TV set is automatically switched to the programme position from which the recording is to be made at a time which is the number of minutes programmed as the VPS lead time before the programmed starting time for the recording. By default, the TV set switches to this programme position about one hour before the programmed start time for a VPS recording.

Setting the lead time, VPS lead time and overrun time

- Press the "MENU" key to open the TV menu.
- Press the green key to open the "Timer" menu.
- Use the corresponding numeric key (in the example: **5**) to select the menu item "Recording control".
- Use the cursor control key to select the desired menu item.
- Press the "OK" key and then, in the setting window, use the - + key to set the desired lead or overrun time.
- Press the "OK" key to save the settings.
- Press the "EXIT" key to close the TV menu.

17.2 Recording control

Application example:

You wish to record a programme received via DVB-T. The programme starts at 22:45 hours, ends at 23:40 hours and is broadcast on ITV.

Set up a "manual timer" as described in Section 18, "Special Functions 2, Timer Overview" or set a timer with the aid of the EPG as described in Section 22.3 "Using EPG, Recording a Programme". The timer recording does not use VPS.

Set the lead time to 3 minutes and the overrun time to 10 minutes.

At the programmed start time minus the programmed lead time of three minutes, the TV set is either:

- switched on from the standby state (red LED lights) with the programme position for ITV selected, whereby the screen remains dark but the programme is sent via the EURO socket to your recorder, or
- switched to the programme position for ITV if it is already switched on.

At the programmed end of the recording (at 23:40 hours) the programme position for ITV remains selected for the programmed overrun time of 10 minutes.

 ***It is not possible to switch to another programme position during the programmed lead and overrun times.***

Opening the menu

F1

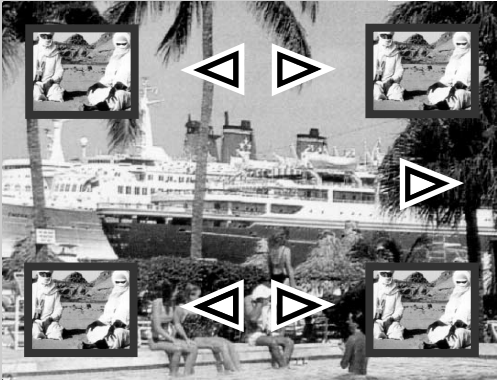

18. Special Functions Picture-in-Picture

On TV sets equipped with only one tuner, the picture-in-picture (PIP) function can only be used to display the picture from an AV device.

On TV sets with two tuners, the picture from another station or from an AV device can be displayed.

Activating the PIP function

- The **F1** key is pre-programmed with the picture-in-picture function.
- You can use the cursor control keys ◀▶ to move the PIP picture on the screen. The last position to which this picture was set is saved.
- By pressing the "OK" key, you can set the frame of the PIP picture to active (red) or inactive (white).
- The contents of the PIP picture can be changed only if its frame is active (red). If this is the case, you can use the numeric keys or the "P+/P-" rocker key to select a different AV programme position.

If you wish to display the picture from a connected AV device as a picture-in-picture, press the "AV" key and then use the **numeric keys** to select the desired AV device.

If you wish to display the picture from another station, use the numeric keys to select the desired programme position.

- Pressing the red key Ⓡ swaps the contents of the two pictures.
- Pressing the green key Ⓢ causes the PIP picture to expand to fill the screen and terminates the PIP function.
- To close the PIP picture, press the "EXIT" key.

👉 If a recording has been programmed in the timer menu, activating the PIP function displays the programme which is being recorded.



EXIT



18. Special Functions

Normal/Speech

Selection of "Normal" or "Speech" is described in Section 12.1, "Tone Settings".

In this menu, you can temporarily select "Normal" or "Speech". The selection remains active until you switch to another programme position, switch to standby mode or switch the TV set off completely.

This setting has no effect of the setting described in Section 12.1, "Tone Settings".

Opening the menu

F2



Special functions 2

1 Normal/Speech

9 Timer-Overview

0 Direct recording

18. Special Functions

Recording a programme with a timer

If you wish to record a programme which your video recorder or DVD recorder cannot receive directly because it does not have a suitable tuner (such as DVB-T or DVB-C), you can use the "Timer overview" to make such programmes available to the recording device.

Opening the menu

F2



9

F1

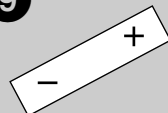

Setting a timer manually for a recording:

- Press the **F2** key. If you press **F2** briefly, the function programmed for **F2** (see Section 18.1, "Programming the function keys") is executed.

If you hold down **F2** for about two seconds, all possible selections are displayed.

- If all possible selections are displayed, press the corresponding numeric key (in the example: **9**) to open the timer menu.

- If a timer already exists, press the **F1** key.
- The cursor is located at the left of the first line "Record". The number of subjects and sections

Recording	Yes	Preview	17:23
Reminder	No	+ Mon Tue Wed Thu Fri Sat Sun 29.04.	
Pr	---		
Date	--:--		
Start	--:--		
End	--:--		
VPS	No		
Recording device	Videorecorder		
Change with	+/-		
	:select.		
OK	:save the timer.		

The number of subjects and sections depends on the selected scope of operation. Depending on the configuration of the TV set, the various menu items may be displayed in a different order and numbered differently.

Opening the menu

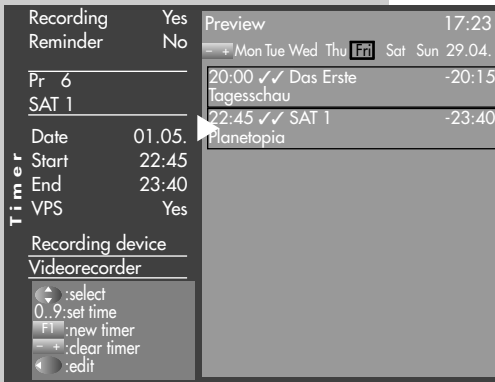
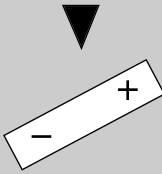

18. Special Functions

Recording a programme with a timer

depends on the selected scope of operation.

Depending on the configuration of the TV set, the various menu items may be displayed in a different order and numbered differently.

Use the - + key to set this menu item to "Yes".

- If desired, press cursor control key ▼ and use the - + key to activate the reminder function. If the reminder function is active, a reminder window is displayed on the screen one minute before the start time programmed for the timer.
- Use the **numeric keys** to select the programme position (see the station table of the TV set) which is to make the programme available for recording.
- Press the cursor control key ▼ and use the **numeric keys** to enter the date, start time and end time of the programme you want to record..

 **If you inadvertently enter a wrong time, you can delete it with the II key or overwrite it with the numeric keys.**

- Press the cursor control key ▼ and use the - + key to select the recording device connected to the TV set which is to be used for the recording.
- Press the "OK" key to save the programmed settings. The settings are stored in the timer memory.
- Press the "EXIT" key to close the TV menu.

Clearing a timer:

- Press the **F2** key.
- Press numeric key **9** to open the timer menu.
- Use the cursor control key to select the timer you wish to clear and press **II** to mark it for deletion. A window is displayed on the screen, asking whether you really want to clear this timer. Confirm the intended action by pressing the appropriate key.

18. Special Functions

Direct recording of a programme

Opening the menu

If you wish to record the programme you are currently watching, you can start a direct (one-touch) recording to make the current programme available to a recording device connected to the EURO sockets.

Starting a direct recording:

- Press the **F2** key.
If you press **F2** briefly, the function programmed for F2 (see Section 18.1, "Programming the Function keys") is executed.
If you hold down **F2** for about two seconds, all possible selections are displayed.



- Press numeric key **0** to open the timer menu window.
The timer menu window displays the programme position, the date and the EPG data for the current programme or for the next two hours.

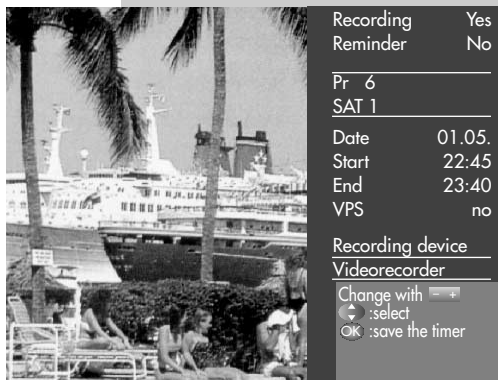

- If there is more than one AV device connected to your TV set, use the cursor control key **▼** to select the proposed recording device and use the **- +** key to select the desired device.
- Press the **"OK"** key to save the settings.

 **On the recording device (e.g. video recorder), select the AV programme position and start the recording by pressing the appropriate button (REC, OTR, etc.).**

Opening the menu

F3

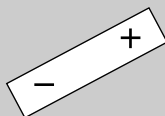
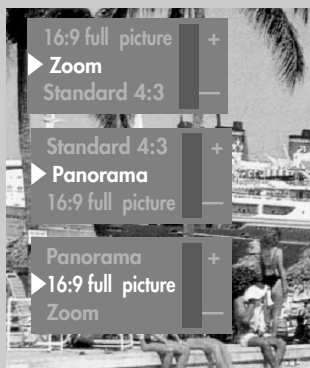

18. Special Functions Picture format

Adjusting the picture format:

- Press the **F3** key.
If you press **F3** briefly, the function programmed for F3 (see Section 18.1, "Programming the Function keys") is executed.
If you hold down **F3** for about two seconds, all possible selections are displayed.
- Press numeric key **1** to select the function "Picture format menu".
- Use the "**P+/P-**" rocker key to select the desired function. After selection of a picture format, you can also adjust the zoom setting by pressing the **- +** key within five seconds.
- The settings made here (except for the automatic zoom set in the TV menu) remain active until you switch to a different programme position or switch off the TV set.

Zoom / Picture position

After selecting the function "Zoom", you can adjust the zoom factor with the **- +** key. In addition, you can move the picture position ⁴⁾ up and down on the screen in order, for example, to keep the station logo or the subtitles visible. To change the picture position, press and hold the **F3** key until the selection is displayed. Then press numeric key **2** and use the "**P+/P-**" rocker key to move the picture.

Standard 4:3

This is the standard setting for all programmes in the 4:3 picture format.

Panorama

With the aid of the panorama function, you can expand programmes broadcast in 4:3 format to fill the screen of a 16:9 TV set. The picture is expanded uniformly in the horizontal direction. You can also zoom the picture. The panorama function can be activated and deactivated in the menu item "General picture settings" of the menu "Picture and sound".

16:9 Full picture

This function serves to display pictures from external devices (such as a 16:9 video recorder) with the correct aspect ratio.

18. Special Functions Picture Position

Opening the menu

If desired, the picture can be shifted up or down in order, for example, to make subtitles visible or to hide "ticker" displays.

F3

Adjusting the picture position:

- Press the **F3** key.
If you press **F3** briefly, the function programmed for F3 (see Section 18.1, "Programming the Function keys") is executed.
 - Press numeric key **2** to select the function "Picture position vertical".
 - You can now use the - + key to move the picture up and down on the screen so that, for example, the station logo or the subtitles are visible.
-  ***This setting is not saved. If you wish to save it as a global setting, use the procedure described in Section 11 to set it.***



Special functions 3

- 1 Picture format
- 2 Pic. form., vertical

Opening the menu

18.1 Programming the Function Keys

F2



Special functions 2

1 Normal/Speech

9 Timer overview

0 Direct recording

The remote control has four function keys: F1, F2, F3 and AV. You can programme these function keys with any of the available functions.

If you press and hold any function key, a window with the available functions is displayed. The picture on the left shows the functions available for the F2 key.

Programming function key F1, F2, F3 or AV with a function



- Press the "MENU" key to open the TV menu.

MENU



F1



- Press the red key  to open the "Configuration" menu.
- Press and hold the **F1** key to display the available functions.
- Use the cursor control key  or the corresponding numeric keys to select the desired "Function for.." (in this example: F2).
- Press the "OK" key and then use the cursor control key to select one of the available functions.
- Press the "OK" key to assign this function to the selected function key (the selected function is marked with "X").

- Press the "EXIT" key to close the TV menu.

 **If a function key is programmed with a function, this function can be called by briefly pressing the function key. Pressing and holding the function key displays a list of all available functions.**

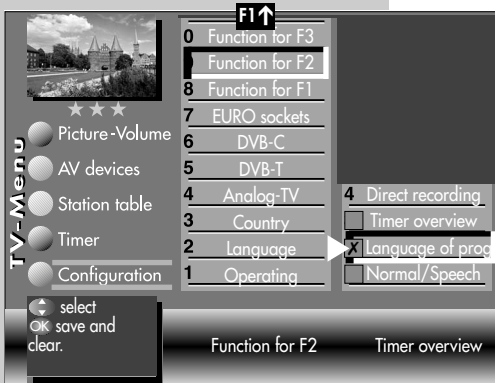

EXIT



19. Sound Settings



Mute Function

Opening the menu

In the menu "Sound settings", you can activate a two-stage mute function.

When this function is active, the volume in TV mode can be reduced in two stages with the mute key .

Activating the mute function

- Press the "MENU" key to open the TV menu.
- Press the red key  to open the "Configuration" menu.
- Press the "OK" key to move to the right side of the menu.
- Use the cursor control key  or the corresponding numeric key (in the example: (3)) to select the menu item "Sound settings".
- In the setting window, use the - + key to set the function "Mute (2-stage)" to "On".
- Press the "OK" key to save the setting.
- Press the "EXIT" key to close the TV menu.

In normal TV mode, the mute key  is used as follows:

- Press it once to reduce the volume by 12 scale divisions.
- Press it again within five seconds to reduce the volume to "00".
- Pressing the  key once again restores the volume to its original level.

MENU



OK

3

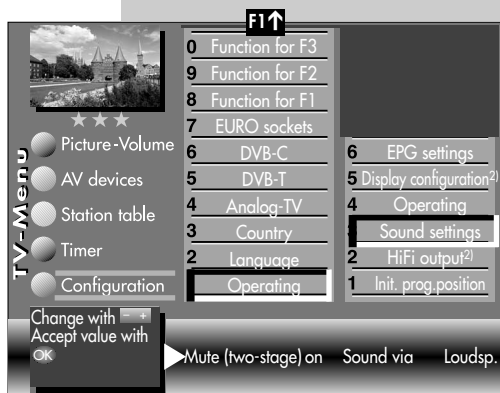

OK

EXIT



20. EPG

EPG is an **E**lectronic **P**rogram **G**uide containing programme information for all important stations. It is broadcast by various stations (in Germany by Kabel1 and RTL 2) and also includes the data for the other TV stations in the country.

The TV set needs about 30 minutes to initially download the large amount of data.

- On TV sets with two tuners, the EPG data are downloaded with the aid of the second tuner (see the next page). Once the data have been downloaded, the TV set stores the EPG in a special memory.

The EPG in this memory is updated regularly, providing the TV set is not switched off with the main power switch.

- On TV sets with only one tuner:
 - the EPG programme position must remain selected for at least 30 minutes, or
 - the data are downloaded at night (02:30 - 03:00) when the TV set is in standby mode.

Not possible with an external receiver !

20.1 Activating the EPG

The EPG function can be activated by briefly pressing the "EPG" key if an EPG programme position has been defined in the menu (see below). If no EPG programme position has been defined in the menu, the following applies.

When any programme position on which EPG can be received is selected, the following is displayed after a short delay:



Use this station as EPG station ?

Yes

Any other key closes this window.

The TV set is thus asking whether you want to use this station as the source for the EPG data.

If you press any key other than the green key, this programme position is not used as the source of EPG data. The message will be displayed again on any other programme position where the EPG data are available.

If you press the green key for "Yes", this programme position will be used as the source for the EPG data. The message will not be displayed for any other programme positions.

If you know which programme position provides EPG data, you can enter its number in the TV menu with the numeric keys.

You can also overwrite an existing programme position number or clear it with the key.

Opening the menu

EPG



MENU

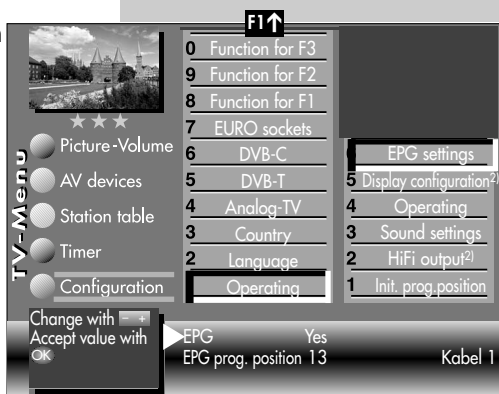

The number of subjects and sections depends on the selected scope of operation. Depending on the configuration of the TV set, the various menu items may be displayed in a different order and numbered differently.

Not possible with an external receiver !

20.2 Collecting EPG Data

The Electronic Programme Guides are broadcast by several different stations, and the information is therefore presented in various layouts. You can thus choose between different EPGs with different appearances.



- TV set with a single tuner: select the EPG programme position and leave it selected for 30 minutes
- TV set with two tuners: the TV set collects the EPG data with the aid of the second tuner.





Special notes:

All stations which are found by a station search are displayed in the station table and also listed in the EPG. Stations which carry two different programmes at different times of the day must be stored in two programme positions (see Section 24).

You can select which stations are to be listed in the EPG.

Normally, the data for all stations are collected and displayed. If you wish to exclude certain stations from the EPG, proceed as follows:

- Press the "MENU" key to open the TV menu.
- Press the white key  to display the menu station table with the active programme position marked.
- Press the **F2** key to enable editing of the station table.
- Press the cursor control key  to move to the subjects list.

- Press numeric key **2** to delete the mark (x) at the beginning of the line "Include station in EPG".
- If you wish to exclude further stations from the EPG, use the cursor control keys     to select each station and repeat the above step.

The data collection operation is interrupted if:

- the Teletext function is called;
- a recording is programmed in the menu "AV recording";
- a "timer recording" is active or will start within one hour;
- the Teletext function "Subtitles" is activated.

If you switch the TV set to the standby state during the data-collection operation, the green LED lights or "EPG" is displayed to indicate that data collection is still running.







Not possible with an external receiver !

20.3 Using the EPG

Opening the menu

Once all of the EPG data have been collected, briefly pressing the "EPG" key displays the EPG with the current programme on the selected programme position highlighted.

The following keys have special functions in EPG mode:

-  Select a programme.
-  View the selected programme or set a reminder for it.
-  Scroll to earlier or later programmes.
- 0-9 Enter a time for display of the programmes starting at or after this time.
-  Back to the previous programme of the selected station.
-  Show all following programmes of the selected station.
-  Forward to the following programme of the selected station.
- blue: Select all programmes.
- yellow: Programme selection on the basis of the selected user and his interests.
- white: User can set interests.
- green: Select user (father, mother, teenager, child).
- red: Make the selected programme available for recording (see page 51).
- EXIT: Back to the TV picture.
- + -: Scroll by days through the EPG

EPG



EXIT



Not possible with an external receiver !

Selecting a programme and viewing or setting a reminder

In the EPG, you can select a programme with the cursor control key.

- Press the "OK" key in order to
 - view the programme if it is already running, or
 - set a reminder for it if it has not yet started. A green check mark is displayed after the start time.
- Press the "TEXT" key to display and hide a description of the programme. This may not be possible for some programmes.

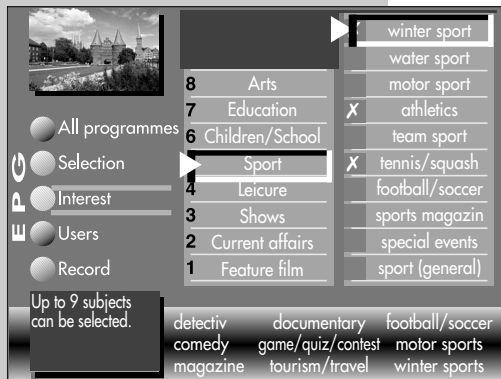

Setting a user profile

By pressing the green key several times, it is possible to set up the EPG for the current user (father, mother, teenager, child).



Setting interests

Each user can set up the EPG to reflect his or her special interests.

- Press the white key .
- Use the cursor control key or the corresponding numeric key to select one of the subjects.
- Use the cursor control key  to move to the other side.

- Use the cursor control key or the corresponding numeric keys to select one of the subjects and mark X it by pressing the "OK" key.

 **Up to nine subjects of interest can be marked for each user.**

- You can delete a mark X by pressing the "OK" key again.
- Press the red key  to save the selections.

Not possible with an external receiver !

20.3 Using the EPG

Opening the menu

Programme Information (Now Showing: ..)

After switching to a channel, a box is displayed at the bottom of the screen as shown in the picture.

This box contains the following information:

- Channel number (in this example: Pr4).
- Audio mode (stereo/mono).
- Start/end time of the programme
- The time bar shows the elapsed programme time.
- Broadcasting station
- Programme title
- Date and time
- Time details and title of the following programme

Press the green key  to view additional information about the programme currently showing, provided the respective station broadcasts such information.

Repeatedly press the green key  to view additional information about the following programme, provided the respective station broadcasts such information.

This information can also be accessed while a programme is running.

To hide the information, press "EXIT".



EXIT



Not possible with an external receiver !

Opening the menu



20.3 Using the EPG Recording a Programme

Selecting a programme for recording:

If you have a video recorder with the dialogue system, the EPG permits you to start a recording by pressing a single key.

- Press the "EPG" key to open the EPG.
- Use the cursor control key to select the programme you wish to record.

If a video recorder with dialogue system is connected (see also Section 25):



- Switch on the video recorder.

- Insert a cassette.

- Press the red key  on the remote control.

If a normal video recorder is connected:

- Switch on the video recorder.

- Insert a cassette.

- Press the red key  on the remote control to programme the TV timer (see also "Direct recording (OTR)").

- On the AV programme position of the video recorder, programme a timer with the data and time of the programme which will be provided by the TV timer.



Not possible with an external receiver !

21. Setting the Country and Language

Opening the menu

 *The menu items "Language" and "Country" are not available in a 2 ** menu.*

MENU

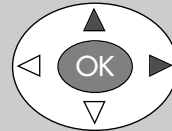

Selecting the language in the TV menu

You can select any of the available languages for the TV menu. All texts in the menu and in the help screen (Information) are then displayed in the selected language.

Setting the country

After installation of the TV set, you must enter the country in which it is installed (such as Great Britain) in order to assign certain basic settings (such as the channel assignments, the order in which the stations are stored, etc.).

Setting language and country:

- Press the "MENU" key to open the TV menu.
- Press the red key  to open the menu "Configuration".
- Use the corresponding **numeric keys** to select "Language" or "Country".
- Press the "OK" key and then use the cursor control key to select the desired language or country.
- Press the "OK" key to confirm your selection.
- Press the "EXIT" key to close the TV menu.

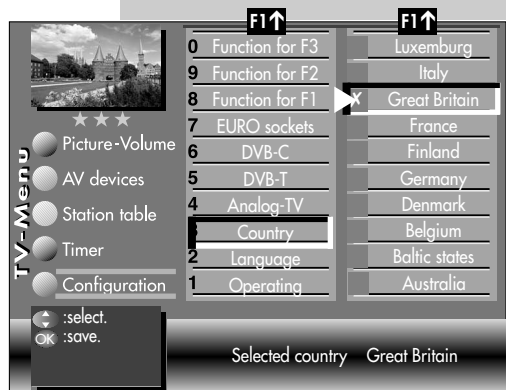
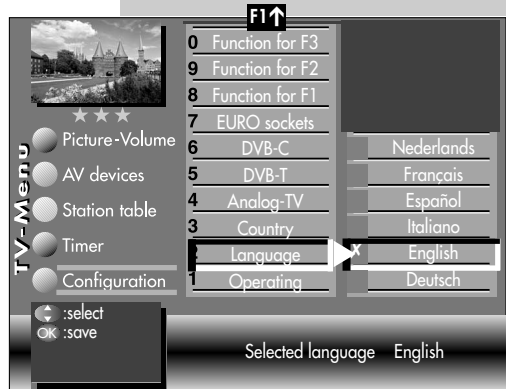

The number of subjects and sections depends on the selected scope of operation. Depending on the configuration of the TV set, the various menu items may be displayed in a different order and numbered differently.

Opening the menu

22. Setting Stations

Setting the reception mode

This TV set is capable of operating in three different reception modes:

Analogue TV:

The broadcasting technology which has been used for many years. The signals can be received via a rooftop antenna or a cable.

DVB-T:

The new digital broadcasting technology whose signals can be received via an existing (analogue) rooftop antenna or an indoor antenna (depending on the strength of the available signal). For more details, please consult your local TV dealer or search for "DVB-T" in the Internet.

DVB-C:

The new digital broadcasting technology whose signals are received via a cable connection. For further details, please consult your local cable provider or TV dealer or search for "DVB-C" in the Internet.

Select the reception mode to match the broadcasting technology available in your area.

MENU



4

5

6

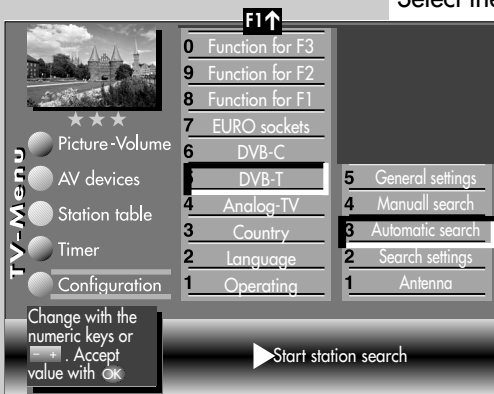

Setting the reception mode

- Press the "MENU" key to open the TV menu.
- Press the red key (🔴) to open the menu "Configuration".
- Use the corresponding **numeric key** to select the appropriate reception mode "Analogue TV", "DVB-T" or "DVB-C".

The number of subjects and sections depends on the selected scope of operation. Depending on the configuration of the TV set, the various menu items may be displayed in a different order and numbered differently.

22.1 Setting Stations

TV-Standard 2) for analogue stations

Various TV standards for picture and sound are used in different countries. If the wrong TV standard is selected, you will not be able to hear the sound, or it will be distorted. The TV standard "L" also uses a different standard for transmission of the picture. The TV standard must therefore be set before you execute a station search.

The TV set is set in the factory to the TV standard B/G.

Setting the TV standard 2)

- Press the "MENU" key to open the TV menu.
- Press the red key  to open the menu "Configuration".
- Use the corresponding numeric key (in the example: **4**) to select "Analogue TV".
- The menu item "Search settings" is already selected.
- Press the "OK" key and, in the setting window, use the - + key to select the desired TV standard.
- Press the "OK" key to confirm your selection.
- Press the "EXIT" key to close the TV menu.

Opening the menu

MENU

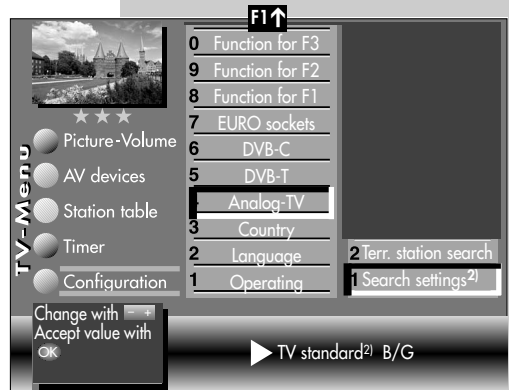

The number of subjects and sections depends on the selected scope of operation. Depending on the configuration of the TV set, the various menu items may be displayed in a different order and numbered differently.

2) Possible only on sets equipped with this function.

Opening the menu

MENU

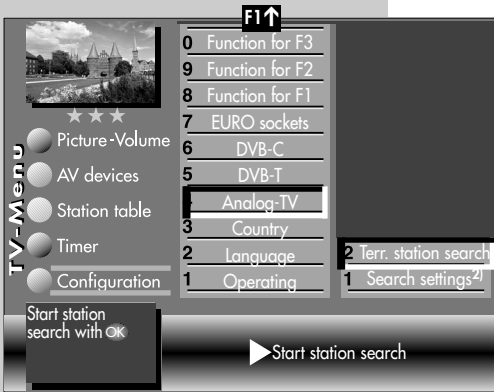
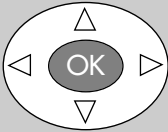

22.1 Setting Stations Analogue TV

Terrestrial station search

The terrestrial station search automatically searches the entire range of available reception frequencies for stations. All stations which are found are placed in the station table which is displayed at the end of the search operation. If you are not satisfied with the order in which the stations are displayed, you can move them to other positions or delete unwanted stations (see Section 24., "Sorting stations").

Executing a terrestrial station search

- Press the "MENU" key to open the TV menu.
- Press the red key to open the menu "Configuration".
- Use the corresponding **numeric key** (in the example: **(4)**) to select "Analogue TV".
- Use the corresponding numeric key (in the example: **(2)**) to select "Terr. station search".
- Press the "OK" key and, in the setting window, confirm the menu item "Start station search" by pressing the "OK" key.
- The TV set starts to search for available stations. A station table with the newly found stations is displayed on the left half of the screen. If a station table already existed before the search, the newly found stations are automatically appended after the last existing station.
- After completion of the search, all stations which have been found are sorted.
- You can delete any unwanted stations from the station table by selecting them with the cursor control key and pressing the **II** key.

The number of subjects and sections depends on the selected scope of operation. Depending on the configuration of the TV set, the various menu items may be displayed in a different order and numbered differently.

2) Possible only on sets equipped with this function.

22.1 Setting Stations



Colour standard for analogue stations

The TV set will normally detect the colour standard (PAL, SECAM, NTSC, NTSC44, PAL60, PAL M) automatically.

If this automatic selection does not provide satisfactory results (which should happen only rarely), you can select the colour standard manually for each programme position.

The colour standard is set in the factory to "Automatic".

Setting the colour standard

- Press the "MENU" key to open the TV menu.
- Press the white key  to open the station table.
- Press the F2 key to enable editing of the station table.
- Use the cursor control key to select the programme position whose colour standard you wish to change.
- Press the cursor control key  to move to the left column.
- Use the corresponding numeric key (in the example: **6**) to select "Colour standard".
- Use the - + key to select the desired colour standard, or to step through the available colour standards until the picture is displayed clearly.
- Press the "OK" key to confirm your selection.
- Press the "EXIT" key to close the TV menu.

Opening the menu

MENU



F2



6

F1↑

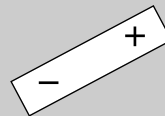
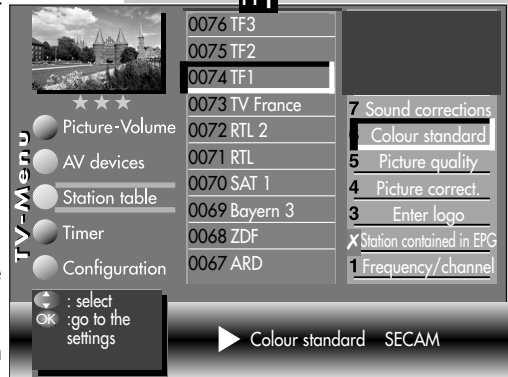

OK

EXIT



The number of subjects and sections depends on the configuration of the TV set, the various menu items may be displayed in a different order and numbered differently.

Opening the menu

MENU



5

3

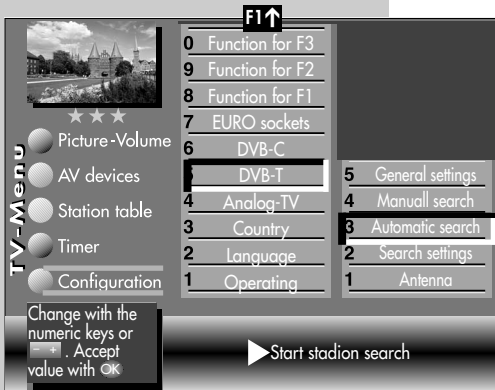

OK

The number of subjects and sections depends on the selected scope of operation. Depending on the configuration of the TV set, the various menu items may be displayed in a different order and numbered differently.

22.2 Setting Stations

Automatic DVB-T station search

DVB-T station search

The DVB-T station search operation searches the entire frequency band for **TV and radio stations**. All stations which are found are placed in separate TV and radio station tables. See Section 29. for details of DVB radio mode.

If you are not satisfied with the order in which the stations are displayed, you can move them to other positions or delete unwanted stations (see Section 24., "Sorting stations").

Executing the automatic station search

- Press the "MENU" key to open the TV menu.
 - Press the red key to open the menu "Configuration".
 - Use the corresponding **numeric key** (in the example: **5**) to select "DVB-T".
 - In the setting window "Antenna", you can switch the supply voltage for an antenna on or off with the - + key.
- Normal setting = Off !**
- The setting "On" may be used only if you have an active **indoor antenna** which needs a supply voltage for its internal amplifier.
 - Use the corresponding numeric key (in the example: **2**) to select "Search settings".

- In the setting window, use the - + key to select one of the following:

All = search for all stations.

FTA only = search for only unencrypted (free-to-air) stations.

FTA +CICAM = search for FTA stations and stations which can be decoded with a CI module (accessory).

- Press the "OK" key and use the corresponding numeric key (in the example: **3**) to select "Automatic search".
- Press the "OK" key to start the search. The TV set now searches for available stations.

22.2 Setting Stations

Manual DVB-T station search

Opening the menu

For a manual station search, you must know the channel number or the frequency of the station you wish to find.

Executing the manual search

- Press the "MENU" key to open the TV menu.
- Press the red key  to open the menu "Configuration".
- Use the corresponding **numeric key** (in the example: **5**) to select "DVB-T".
- In the setting window "Antenna", you can switch the supply voltage for an antenna on or off with the - + key (see also page 58).
- Use the corresponding numeric key (in the example: **2**) to select "search settings".
- In the setting window, use the - + key to select "All", "FTA only" or "FTA + CICAM" (see also page 58).
- Press the "OK" key and use the corresponding numeric key (in the example: **4**) to select "Manual search".
- In the setting window, use the **numeric keys** to enter the channel number or the frequency.

MENU

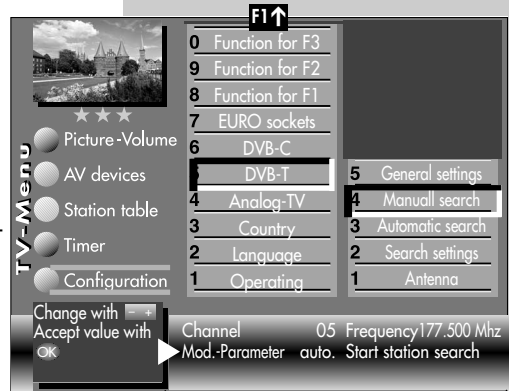

If you know further data of the desired station, select the menu item "Mod. parameter" and use the - + key to change the setting there to "Manual". You can then enter further data.

- After input of the station data, use the cursor control key to select the menu item "Station search" and press the "OK" key to confirm your selection.
The station settings are saved.

Transmission 8k Mode Modulation 64 QAM
Mod. Parameter manuell Guard Intervall 1/8
Code rate 3/4 Start station search

The number of subjects and sections depends on the selected scope of operation. Depending on the configuration of the TV set, the various menu items may be displayed in a different order and numbered differently.

Opening the menu

MENU



6

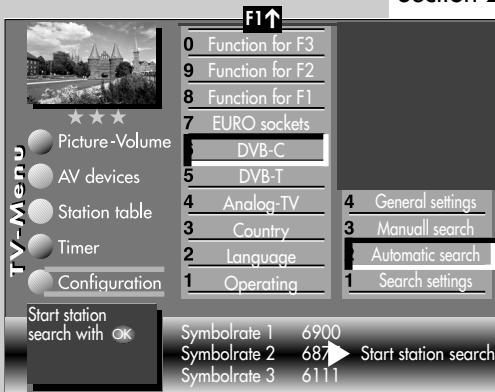

OK

2



OK

The number of subjects and sections depends on the selected scope of operation. Depending on the configuration of the TV set, the various menu items may be displayed in a different order and numbered differently.

22.3 Setting Stations

Automatic DVB-C station search

DVB-C station search

The DVB-C station search operation searches the entire frequency band for **TV and radio stations**. All stations which are found are placed in separate TV and radio station tables. See Section 29 for details of DVB radio mode.

If you are not satisfied with the order in which the stations are displayed, you can move them to other positions or delete unwanted stations (see Section 24., "Sorting stations").

Executing the automatic search

- Press the "MENU" key to open the TV menu.
 - Press the red key to open the menu "Configuration".
 - Press the numeric key **6** to select "DVB-C".
 - The cursor is now on the menu line "Search settings".
 - Press the "OK" key and, in the setting window, use the - + key to select "All", "FTA only" or "FTA +CICAM" (see also page 58).
 - Press the "OK" key and then press the corresponding numeric key (in the example: **2**) to select "Automatic search". The cursor is now on the line "Symbol rate 1".
- The most common symbol rates are already preset. Usually these settings do not need to be modified. If the symbol-rate settings do not yield the desired result, set other symbol rates and save them by pressing "OK". Ask your cable operator for details.**
- Press the cursor control key to select the menu line "Start station search".
 - Press the "OK" key to start the search. The TV set now searches for available stations.

22.3 Setting Stations

Manual DVB-C station search

Opening the menu

For a manual station search, you must know the channel number or the frequency of the station you wish to find.

Executing the manual search

- Press the "MENU" key to open the TV menu.
- Press the red key  to open the menu "Configuration".
- Use the corresponding **numeric key** (in the example: **6**) to select "DVB-C".
- The cursor is on the menu line "Search settings".
- Press the "OK" key and, in the setting window, use the - + key to select "All", "FTA only" or "FTA +CICAM" (see also page 58).
- Press the "OK" key and use the corresponding numeric key (in the example: **3**) to select "Manual search".
- The cursor points to "Channel".
- In the setting window, use the numeric keys to enter the channel number (or special channel number) or the frequency of the desired station.

If you know further data of the desired station, select the menu items "Modulation" and "Symbol rate" and use the - + key or the numeric keys to change the settings there.

- After input of the station data, use the cursor control key to select the menu item "Station search" and press the "OK" key to confirm your selection.
The station settings are saved.

MENU

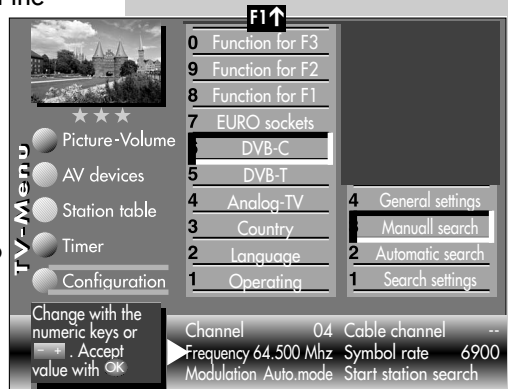

Channel 04 Cable channel --
 Frequency 64.500 Mhz Symbol rate 6900
 Modulation 128 QAM Start station search

OK

3

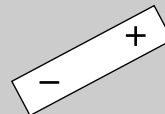

The number of subjects and sections depends on the selected scope of operation. Depending on the configuration of the TV set, the various menu items may be displayed in a different order and numbered differently.

Opening the menu

23. Station Logo

MENU



F2



3

With the aid of the VPS signal, a station logo with a maximum length of 15 characters is automatically assigned to each station.

If this automatic assignment does not work, or if you want to use a different logo, you can change the setting manually.

Setting the station logo

- Press the "MENU" key.
- Press the white key to open the "station table".
- Press the **F2** key to enable editing of the station table.
- Select the programme position whose logo you wish to change.
- Press the cursor control key to move to the other column.
- Use the corresponding numeric key (in the example: **3**) to select "Logo input".
- The various letters and digits can be selected with the aid of the cursor control key .
- You can delete single characters with the red key or the complete logo with the key.

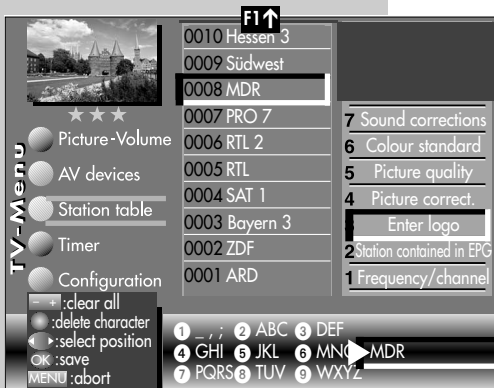

OK

EXIT





The number of subjects and sections depends on the selected scope of operation. Depending on the configuration of the TV set, the various menu items may be displayed in a different order and numbered differently.

24. Sorting Stations

Opening the menu

You can move, copy and delete individual stations or groups of stations within the station table.







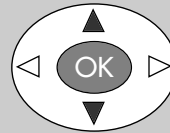



Moving, copying and deleting stations

- Press the "MENU" key to open the TV menu.
- Press the white key  to open the station table.
- Use the **cursor control key** to select the programme position which is to be moved, copied or deleted. You can also mark a contiguous block of positions by moving the cursor to the programme position at the end of the block.
- Briefly press the **OK** key to mark the programme position (in the example: position 008). Press and hold the **OK** key to mark all programme positions in the previously selected block.
- To copy this programme position, use the cursor to select the programme position before or after which the selected station is to be inserted. If the station(s) you have selected were previously in programme positions with lower numbers than the insertion position, they are inserted before this position; if they previously had higher numbers, they are inserted after this position.
- To move the selected station(s), select the programme position to which the station(s) is/are to be moved.
- Use the - + key to copy (+) or move (-) the station(s).
- To delete a station, press the  key.
- Press the "EXIT" key to close the TV menu.

MENU



F11

	0010 Hessen 3	0020 BR alpha
	0009 Südwest	0019 3 SAT
	0008 MDR	0018 Kinderkan.
	0007 PRO 7	0017 FRANKEN
	0006 RTL 2	0016 TELE-5
	0005 RTL	0015 9LIVE
	0004 SAT 1	0014 SuperRTL
	0003 Bayern 3	0013 Kabel 1
	0002 ZDF	0012 VOX
	0001 ARD	0011 West 3

TV-Menu

- Picture-Volume
- AV devices
- Station table
- Timer
- Configuration

← : select
F2 : edit programme attributes or station list.

Moving, copying, deleting:
Select station with **OK** (hold down to select a block)
Select new position with the cursor
- + : move/copy,  : delete

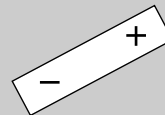

EXIT



Opening the menu

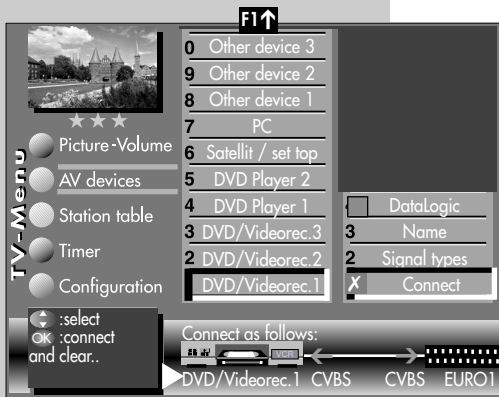
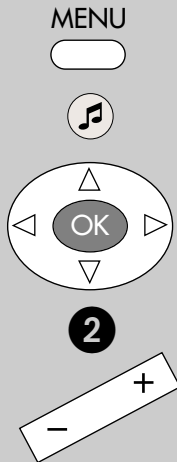

Caution! Connection of a new device may cause an existing connection diagram to be changed. If so, you must reconnect the AV devices accordingly.

25. Registering AV Devices

AV (audio/video) **devices** are external devices which deliver video and/or audio signals (such as video recorders, DVD players, DVD recorders, etc.) and which can be connected to TV sets.

All commonly available AV devices are listed in the menu "AV devices".

Note that you must always connect AV devices exactly as shown in the connection diagram in the TV menu of your TV set !

SVHS/Hi8 and Data Logic video recorders **must** always be connected to the EURO1 socket of the TV set.

In the factory, the EURO1 socket is programmed for a video recorder and the EURO2 socket is programmed for a DVD player.

Registering an AV device on the TV set

- Press the "MENU" key to open the TV menu.
- Press the yellow key to open the menu "AV devices".
- Use the cursor control key to select the AV device you wish to register and press the "OK" key.
- Press numeric key **2** and use the - + key to select the appropriate signal types (OUT/IN) for this device and press "OK" to confirm your selection. For details of the signal types, see page 66 and the operating instructions for the AV device being connected.
- If desired, press numeric key **3**, enter a different name for this AV device and press "OK".
- Use the cursor control key to select "Connect" and press the "OK" key. Then connect the AV device to the corresponding EURO socket.

25. Registering AV Devices

Data Logic

Opening the menu

Data Logic video recorder

i "Data Logic" is a system which provides a dialogue between a TV set and a video recorder. This "intelligent" system offers the features such as:

- Automatic transfer of the settings for terrestrial or cable TV stations (not DVB) to the video recorder.
- Immediate recording - the video recorder records the programme currently displayed on the TV screen.
- Automatic switching to the AV programme position.
- Direct control of the video recorder from the timer menu of the TV set.
- Automatic switching off of the video recorder when the TV set is switched to the standby state.

In the menu "AV devices" check **X** to the left of the field "Data Logic" for "Video recorder 1" and connect the video recorder to the EURO1 socket.

i *Data Logic will function correctly only if the AV-1 socket on the video recorder is connected to the EURO 1 socket on the TV set.*

Comparable dialogue systems are: QLink (Panasonic), EasyLink (Philips), Megalogic (Grundig), SMARTLINK (Sony).

i *This menu item is not available in a 2 ** menu.*

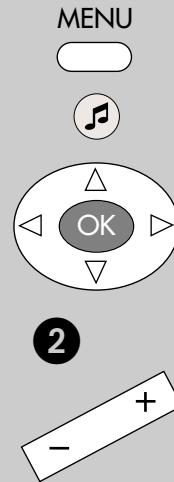

Registering a Data Logic video recorder on the TV set

- Press the "MENU" key to open the TV menu.
- Press the yellow key to open the menu "AV devices".
- Use the cursor control key to select the AV device to be connected and press the "OK" key.

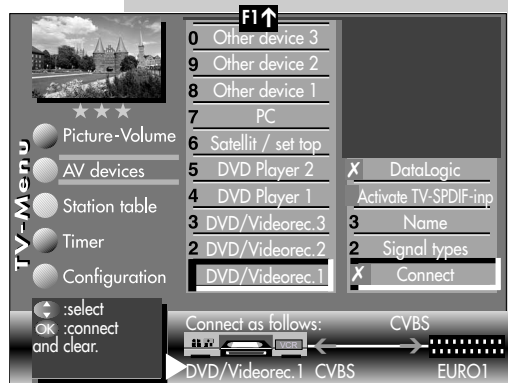

Opening the menu



25. Registering AV Devices Data Logic

- Press numeric key **2**, use the - + key to select the correct signal types (OUT/IN) and press the "OK" key.
(See also the operating instructions of the AV device.)
- If desired, press numeric key **3**, enter a new name for the AV device and press the "OK" key.
- Use the cursor control key to select "Data Logic" and press the "OK" key.
- Use the cursor control key to select "Connect" and press the "OK" key. Then connect the AV device to the corresponding EURO socket.

Data Logic: transferring the station table

- Press the "MENU" key to open the TV menu.
- Press the red key  to open the menu "Configuration".
- Press numeric key **4** to select "Analogue TV".
- Press the "OK" key and then press numeric key **2** to select "Data Logic".
- Press the "OK" key to transfer the programme positions from the TV set to the video recorder.

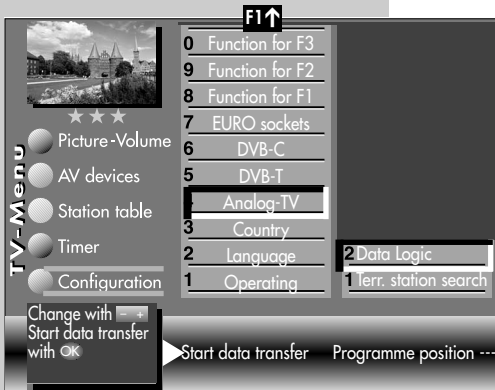

The number of subjects and sections depends on the selected scope of operation. Depending on the configuration of the TV set, the various menu items may be displayed in a different order and numbered differently.

25. Registering AV Devices

Setting signal types RGB

Opening the menu

👉 *The signal type always refers to the input and output of the AV device.*

Some AV devices may use a composite video signal (FBAS) for recording and playback operations and an RGB signal for displaying their menus.

It is not possible to make a general statement in this respect. The operating instructions of the AV device concerned may provide some indication.

If you connect such an AV device with the signal type "composite video" (FBAS) and recordings are played back correctly, but you cannot see the menu of the AV device, you must change the signal type in the menu "AV devices" to "RGB".

Setting the signal type

- Press the "MENU" key to open the TV menu.
- Press the yellow key  to open the menu "AV devices".
- Use the cursor control key to select the AV device whose signal type you wish to change and press the "OK" key.
- Press numeric key **2**, use the cursor control key to select "Signal OUT", and use the - + key to change the setting to "RGB".
- Press the "OK" key to confirm your selection.
- Press the "EXIT" key to close the TV menu.

👉 *Caution ! This may cause an existing connection diagram to be modified. If so, you must reconnect the AV devices accordingly.*

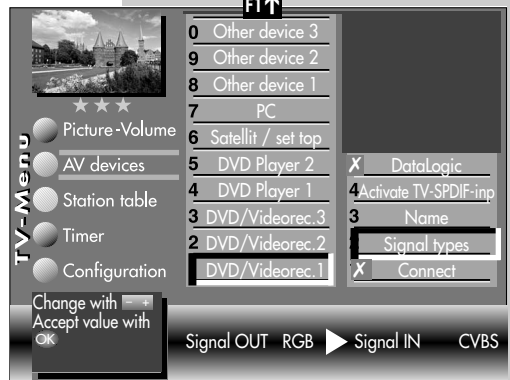
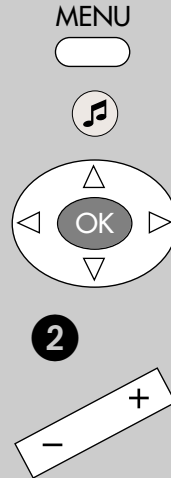

The number of subjects and sections depends on the selected scope of operation. Depending on the configuration of the TV set, the various menu items may be displayed in a different order and numbered differently.

Opening the menu

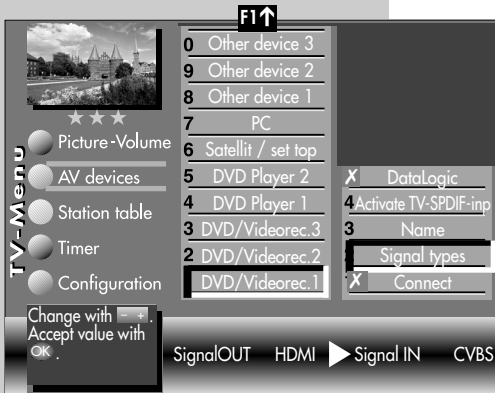
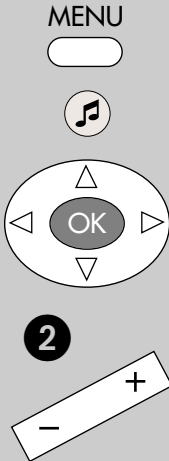

The number of subjects and sections depends on the selected scope of operation. Depending on the configuration of the TV set, the various menu items may be displayed in a different order and numbered differently.

25. Registering AV Devices Setting signal types DVI/HDMI

The signal type always refers to the input and output of the AV device.

AV devices equipped with a DVI or HDMI socket can be connected to the LCD TV with the aid of a DVI or HDMI cable, respectively.

The connected device must be registered in the menu "AV devices" with "Signal OUT" set to "DVI" or "HDMI", as applicable. Connection via a DVI or HDMI interface permits digital transfer of the picture signal from the device to the TV set. The sound signal must be connected with an additional Cinch or optical (Toslink) audio cable.

Setting the signal type DVI or HDMI

- Press the "MENU" key to open the TV menu.
- Press the yellow key to open the menu "AV devices".
- Use the cursor control key to select the AV device whose signal type you wish to change and press the "OK" key.
- Press numeric key **2**, use the cursor control key to select "Signal OUT", and use the - + key to change the setting to "RGB".
- Press the "OK" key to confirm your selection.
- Press the "EXIT" key to close the TV menu.

Caution ! This may cause an existing connection diagram to be modified. If so, you must reconnect the AV devices accordingly.

25. Registering AV Devices

Setting signal types YUV/YUV(HD)

Connection of external devices with YUV component output to the "COMPONENT IN" RCA jacks.

 **The signal type always refers to the input and output of the AV device.**

AV devices equipped with a YUV jack can be connected to the LCD TV by means of a YUV cable (see page 81). In the "AV Devices" menu, the connected AV device must be registered with signal OUT "YUV" or "YUV (HD)".

The connection of the analogue YUV source using the RCA jacks to the YUV input of the LCD TV depends on the output format of the signal source.

Configure the following settings, depending on the output format of your signal source:

Signal type	Source format
YUV	576i
YUV (HD)	576p, 720p, 1080i

Setting the YUV or YUV (HD) Signal Type

- Enter the TV menu by pressing "MENU".
- Press the yellow key to open the "AV Devices" menu.
- Use the cursor control to select the AV device whose signal type you want to change and press "OK".
- Press numeric key **2**, use the cursor control to select "Signal OUT", and use the - + key to set "YUV" or "YUV (HD)".
- Confirm the setting by pressing "OK".
- Exit the "TV Menu" by pressing "EXIT".

 **Caution ! This may cause an existing connection diagram to be modified. If so, you must reconnect the AV devices accordingly.**

Opening the menu

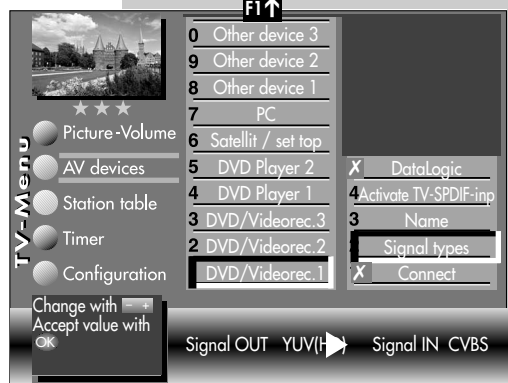
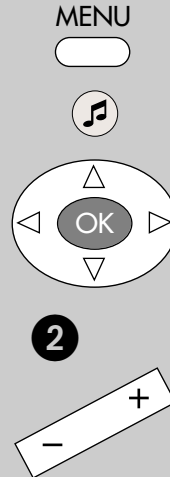

The number of subjects and sections depends on the selected scope of operation. Depending on the configuration of the TV set, the various menu items may be displayed in a different order and numbered differently.

Opening the menu

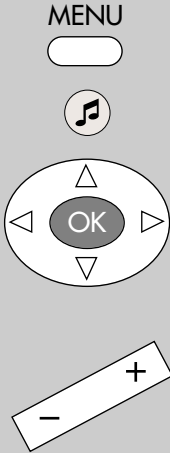

25.1 Removing AV Devices

 *This menu item is not available in a 2 ** menu.*

If desired, you can change the factory settings for AV devices (a video recorder on the EURO1 socket and a DVD player on the EURO2 socket).

Removing an AV device from the TV set

- Press the "MENU" key to open the TV menu.
- Press the yellow key  to open the menu "AV devices".
- Use the cursor control key to select the device you wish to remove and press the "OK" key. The cursor is on the line "Connect".
- Press the "OK" key again. A message is displayed, asking if you really want to change the connected device.
- Press the OK key again to remove the connected device.
- Press the "EXIT" key to close the TV menu.

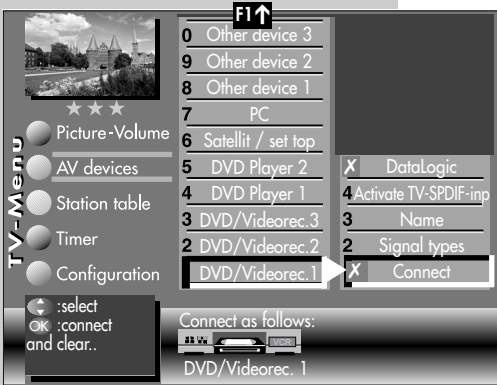

OK

EXIT

The number of subjects and sections depends on the selected scope of operation. Depending on the configuration of the TV set, the various menu items may be displayed in a different order and numbered differently.

26. Initial Programme Position

You can define an initial programme position in this TV set. This initial programme position is used primarily to select the AV programme position if you use an external receiver.

Setting the initial programme position

 ***This menu item is not available in a 2 ** menu.***

Select a receiver (satellite or set-top box) in the menu "AV devices" and connect the receiver to the TV set (see also Section 25, Registering AV Devices").

- Press the "AV" key.
- Use the numeric keys to select the position "Sat/Set-top" in the AV menu.
- Press the "MENU" key to open the TV menu.
- Press the red key  to open the menu "Configuration".
- Use the cursor control key to select "Operation" and then "Initial programme position".
- Press the "OK" key and, in the setting window, use the - + key to select "Yes".
- Press the "OK" key to save the new setting.
- Press the "EXIT" key to close the TV menu.

 ***The AV programme position will now be selected automatically when you switch on the TV set with the main power switch.***

Opening the menu

MENU

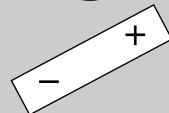
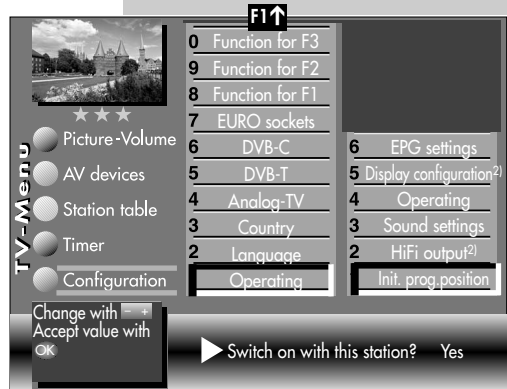

EXIT



The number of subjects and sections depends on the selected scope of operation. Depending on the configuration of the TV set, the various menu items may be displayed in a different order and numbered differently.

2) Possible only on sets equipped with this function.

Opening the menu

MENU

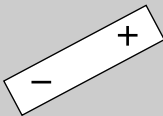
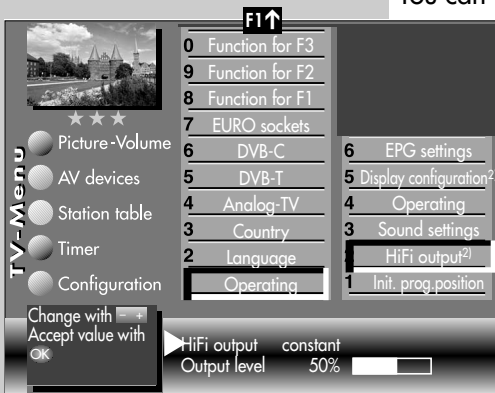

EXIT



The number of subjects and sections depends on the selected scope of operation. Depending on the configuration of the TV set, the various menu items may be displayed in a different order and numbered differently.

27. Sound via HiFi Amplifier HiFi output

On the rear of the TV set, you will find audio sockets and a digital audio-out socket (see page 81) which can be used to connect the TV set to a HiFi system (HiFi amplifier).

Settings need to be made in the menu items "HiFi output" and "Sound settings" only if the TV set is connected to a HiFi system.

If you want adjust the sound settings exclusively on the HiFi system, you must set the HiFi output to constant.

You can then no longer adjust the volume and tone with the Metz remote control. The mute (M) function remains active.

If you want to be able to change the sound settings with the Metz remote control, you must set the HiFi output to variable.

Setting the HiFi output

- Press the "MENU" key to open the TV menu.
- Press the red key (R) to open the menu "Configuration".

- Use the cursor control key (P) to select "Initial programme position".
- Use the corresponding numeric key (in the example: 2) to select "HiFi output".
- In the setting window, use the - + key to set the desired parameters.
- Press the "OK" key to save the new settings.
- Press the "EXIT" key to close the TV menu.

In normal TV Mode, the function "Sound via..." can be activated temporarily by pressing the yellow key (Y) and using the - + key.

27. Sound via HiFi Amplifier

HiFi output



Opening the menu

On the rear of the TV set, you will find audio sockets and a digital audio-out socket (see page 81) which can be used to connect the TV set to a HiFi system (HiFi amplifier).

If you wish to play back the sound only via a HiFi system (HiFi amplifier) which is connected with the aid of a Cinch cable, you must select the function "Sound via HiFi".

If you wish to play back the sound only via a HiFi system (HiFi amplifier) which is connected with the aid of an optical audio cable ("Toslink", available as an accessory), the following settings should not be made.

Setting sound via HiFi

- Press the "MENU" key to open the TV menu.
- Press the red key  to open the menu "Configuration".
- Press the "OK" key to move to the right-hand column.
- Use the cursor control key  or the corresponding numeric key (in the example: **3**) to select "Sound settings".
- In the setting window, use the cursor control key  to select the menu item "Sound via...".
- Use the - + key to select "Sound via HiFi".
- Press the "OK" key to save the new setting.
- Press the "EXIT" key to close the TV menu.

In normal TV Mode, the function "Sound via..." can be activated temporarily by pressing the yellow key  and using the - + key.

MENU

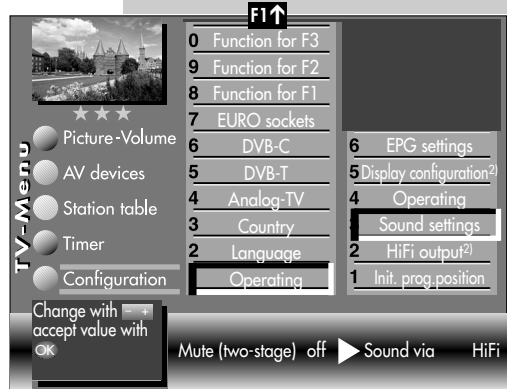

EXIT



The number of subjects and sections depends on the selected scope of operation. Depending on the configuration of the TV set, the various menu items may be displayed in a different order and numbered differently.

2) Possible only on sets equipped with this function.

Opening the menu

MENU



5

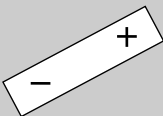
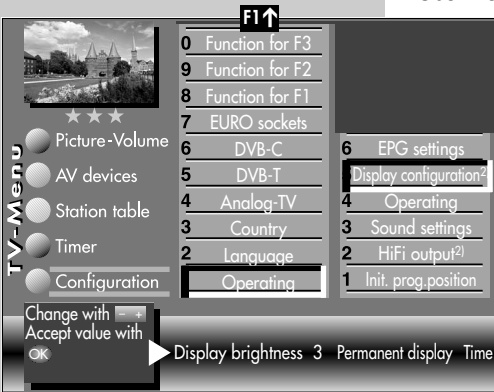

OK

EXIT



The number of subjects and sections depends on the selected scope of operation. Depending on the configuration of the TV set, the various menu items may be displayed in a different order and numbered differently.

2) Possible only on sets equipped with this function.

28. Display Configuration

*This menu item is not available in a 2 ** menu.*

The green digital display on the front of the TV set can be programmed, as desired, to show the time or the current programme position.

Setting the display configuration ²⁾

- Press the "MENU" key to open the TV menu.
- Press the red key to open the menu "Configuration".
- Use the cursor control key to select "Initial programme position".
- Use the corresponding numeric key (in the example: **5**) to select "Display configuration".
- In the setting window, use the . + key to select the desired setting.
- Press the "OK" key to save the new setting.
- Press the "EXIT" key to close the TV menu.

29. DVB Radio Mode

To switch from TV mode to DVB radio mode, press the "R" key.

The screen is automatically blanked after about 30 seconds.

To switch from DVB radio mode to TV mode, press the "TV" key.

Setting DVB radio stations

The available DVB radio stations are automatically detected during a station search (see Section 22) and stored in a separate station table at the operating level for radio mode.

The radio station table can be sorted (see Section 24) and the station logos can be changed (see Section 23).

-  ***DVB radio stations are administered in the same basic way as DVB TV stations. The functions described in Sections 12, 12.1, 15 to 17.2 and 18 (Special functions, Normal/speech, Timer overview and Direct recording) are also available for radio stations.***

Opening the menu





30. Scope of Operation

The adjustable scope of operation for the TV set can be a great help in finding your way around the complex operating functions of the TV set.

The scope of operation can be set to various levels, which are identified by asterisks.

1 ★ "Just watching TV"- in other words, it is not possible to open the TV menu and only the functions available on the remote control can be used:

- Zapping
- Selection of programme positions with the numeric keys, the oval "**P+**/**P-**" rocker key or the white key .
- Opening Teletext.
- Displaying help information (INFO).
- Playing back films from a video recorder or DVD player by pressing the "**AV**" key.
- Selecting "Special functions 1" by pressing the **F1** key.
- Selecting "Special functions 2" by pressing the **F2** key.
- Selecting "Special functions 3" by pressing the **F3** key.
- Selecting connected AV devices by pressing the "**AV**" key.
- Calling the standard picture functions by pressing the blue key .
- Calling the standard sound functions by pressing the yellow key .
- Calling the "EPG" function with the "**EPG**" key.

If the scope of operation is set to a 1 ★ menu and you subsequently want to open a menu, then:

- Press and hold the "**MENU**" key for at least five seconds to open the TV menu.
- The menu item "Operation" is automatically selected.

30. Scope of Operation



Opening the menu

- Use the - + key to select the desired scope of operation and press the "OK" key to save the new setting.
- 2 ★ ★ This menu permits you to configure the use of the TV set to a certain degree. All of the functions listed for the 1 ★ menu are available and are supplemented by the following functions:

- Childlock
- Timer control (sleep timer)
- Automatic station search
- Transfer of the TV station table from the TV set to a Data Logic video recorder.
- Editing functions in the station table

- 3 ★ ★ ★ This is the operating scope for persons who are interested in technology who want to be able to use the full range of functions of the TV set.

Setting the scope of operation

- Press the "MENU" key to open the TV menu.
- Press the red key  to open the menu "Configuration".
- Use the cursor control key  to move to the menu line "Initial programme position".
- Press the numeric key  to select "Scope of operation".
- In the setting window, use the - + key to select the desired scope of operation.

Press the "OK" key to save the new setting.

Press the "EXIT" key to close the TV menu.

MENU

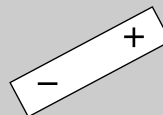
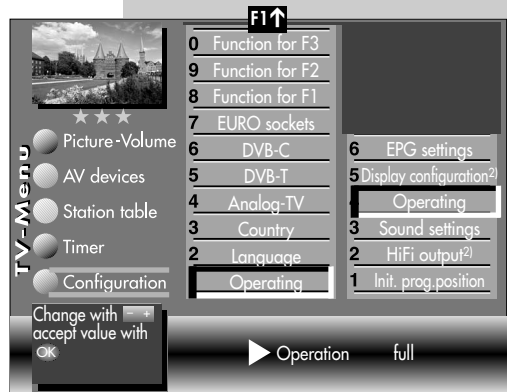

EXIT



The number of subjects and sections depends on the selected scope of operation. Depending on the configuration of the TV set, the various menu items may be displayed in a different order and numbered differently.

31. Operation without the Remote Control

Operation without the remote control is provided as an emergency measure in case the batteries of your remote control are exhausted or the remote control is not readily available.

The local controls are located on the bottom edge of the TV set, on the right.

Switching on

Press the main power switch on the TV set. After about five seconds, the TV set is switched on with programme position 1 or the programmed initial programme position selected.

You can also use the following functions directly on the TV set, without a remote control. For functions which require further adjustments, the function remains preselected for ten seconds.

Programme selection

Press the **-/+** buttons.

Volume

Press and hold the preselection key **F** until the bar display for the volume appears on the screen. Then press the **"-"** or **"+"** button to adjust the volume.

Contrast

Press and hold the preselection key **F** until the bar display for the contrast appears on the screen. Then press the **"-"** or **"+"** button to adjust the contrast.

32. Connecting Headphones

The headphone socket is located behind a flap on the left side of the TV set (see Section 35).

We recommend the use of headphones with an impedance of at least 32 Ω . The use of headphones with a lower impedance will reduce the dynamic range of the sound.

You can save the headphone volume as a standard value.

33. Sound 1, Sound 2



When receiving a dual-language programme, you can switch between the two sound channels.

In TV mode, press and hold the yellow key  until the sound function "Sound mode" is selected.

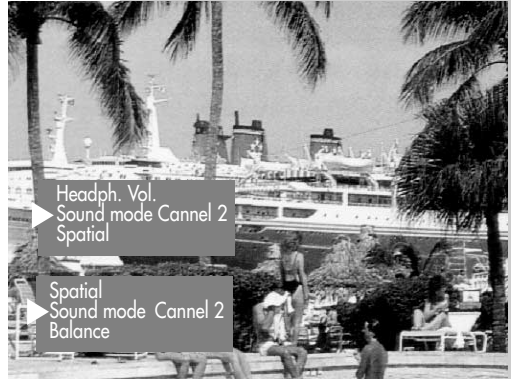
Then use the - + key to select Sound 1 or Sound 2.



34. Cleaning the TV Set

-  **Before cleaning the set, always switch it off with the mains switch!**
-  **Incorrect treatment and cleaning of the screen surface can cause irreparable damage to it. You should therefore always observe the following instructions for treatment and cleaning of the set.**

Treatment:

Always treat the screen surface very carefully.

Take care not to damage it mechanically by shocks, impact, scratching or scraping.

Keep sharp, pointed and hard objects away from the surface of the screen.

Keep the surface of the screen clean.

For cleaning the case and the screen, use only a soft, dry cloth. For removing stubborn marks, you may moisten the cloth slightly.

Cleaning and care:

The surface of the screen may be cleaned only with a soft, dry cloth (such as a microfleece duster). If any marks cannot be removed with this dry cloth, you may moisten the cloth slightly.

Take care that no water or other liquid can enter the TV set, since this can cause serious damage to the set.

If any liquid or other foreign object (pieces of metal, etc.) enters the set, immediately disconnect the mains plug from the wall outlet.

Never insert your hands or tools into the set, since this may result in electric shocks.

35. Connections on the Left/Front Side of the Set

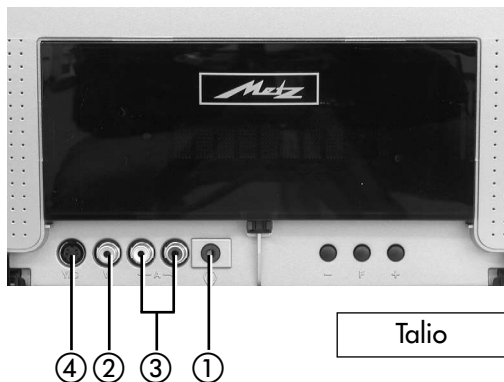
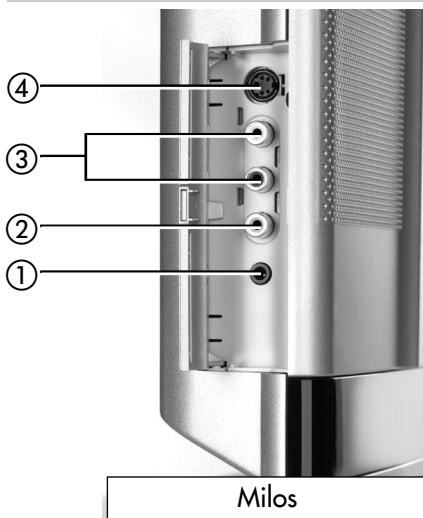

- ① Headphone socket, diameter 3.5 mm
- ② FBAS/Video in (e.g. digital camera or camcorder)
- ③ Audio in R/L (e.g. camcorder)
- ④ S-VHS or Y/C in (e.g. camcorder)

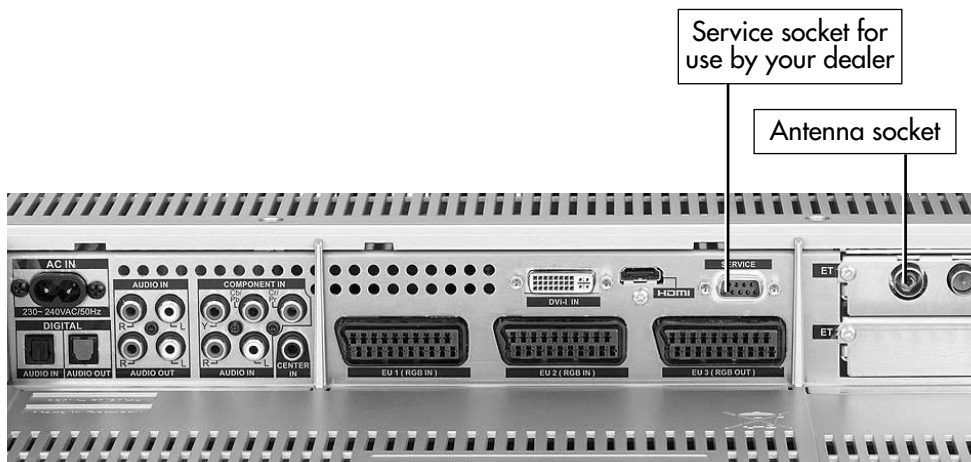

35.1 Connections on the Rear of the Set (covered by a flap) Viewed from below

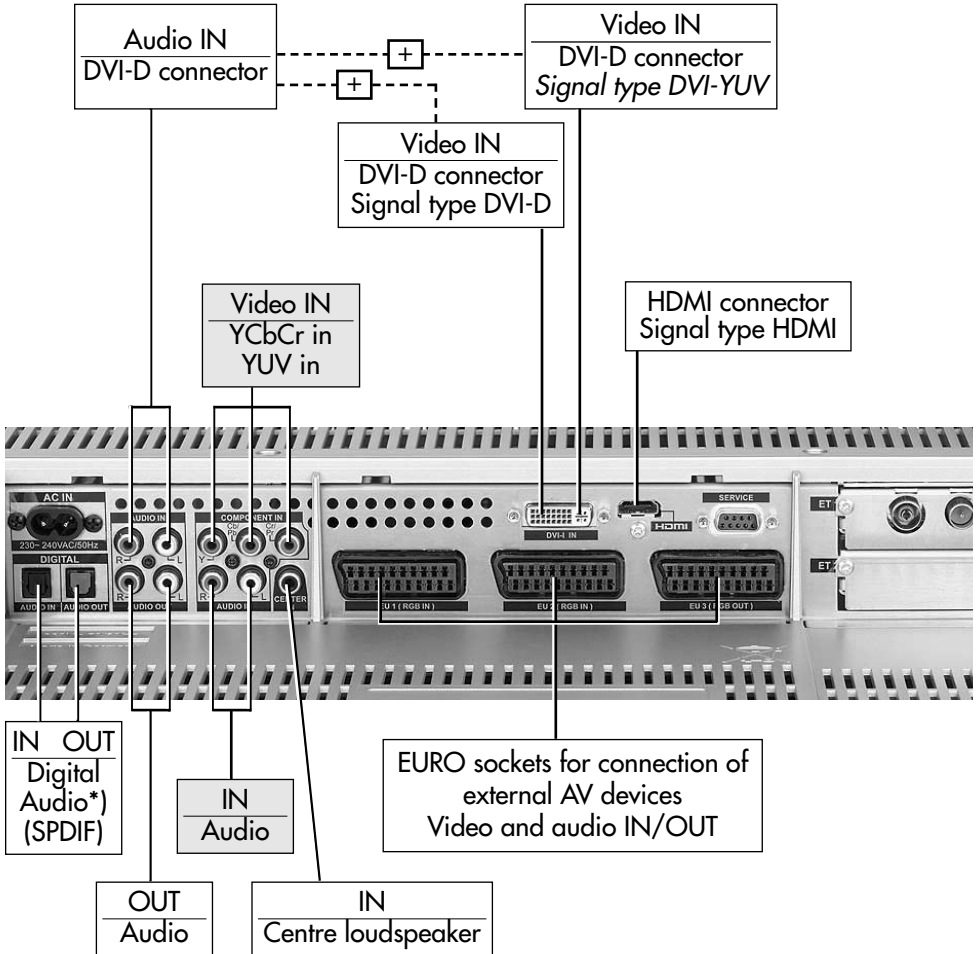

*) The sockets "Digital audio IN" and "Digital audio OUT" can be operated in loop-through mode. To do this, open the menu "AV devices" and activate (x) the menu item "Activate TV SPDIF input".

 **With the aid of an optical audio cable ("Toslink" cable, available from your dealer), the digital audio signal (AC3) provided by the TV set can be extracted for external processing.**

35.1 Connecting a HiFi Amplifier/AV Receiver

Metz LCD-TV

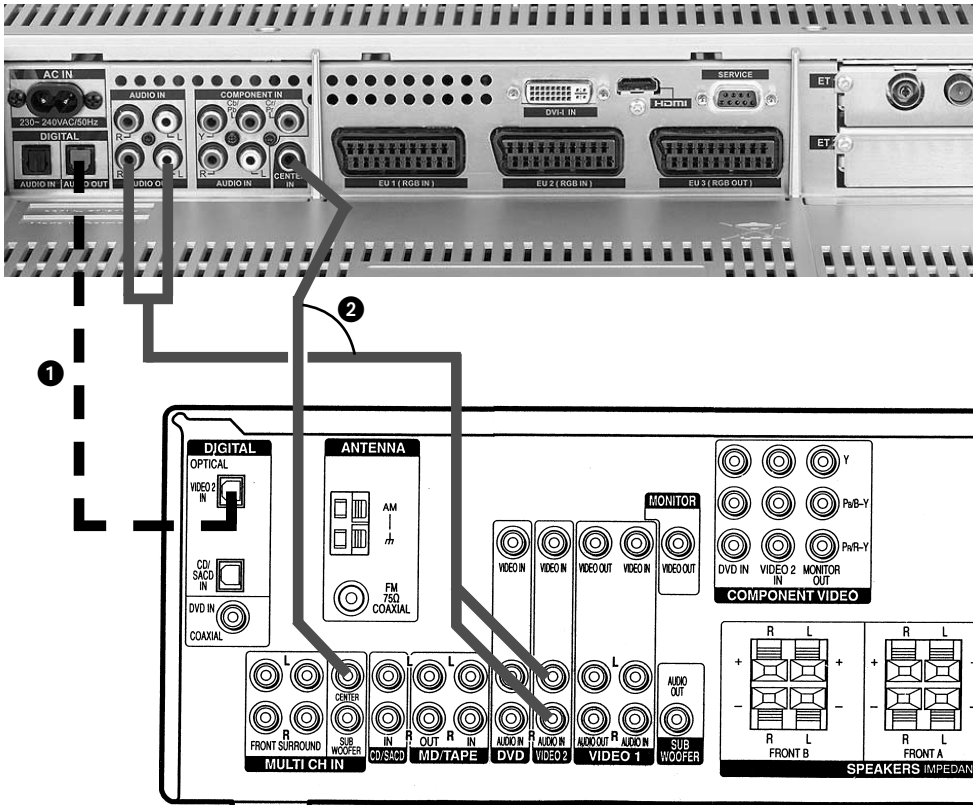



HiFi-amplifier
AV-Receiver



35.1 Connecting a Hifi Amplifier/AV Receiver

Opening the menu

Registering the AV Device with the TV

- Enter the TV menu by pressing "MENU".
- Press the yellow key  to open the "AV Devices" menu.
- Use the cursor control key  to select "Hifi Amplifier" in the device selection.
- Press "OK" twice, use the cursor control key  to select "Signal Types", and press "OK"..
- For connection type **1**, select the signal type "Signal IN - SPDIF".
For connection type **2**, select the signal type "Signal IN - Stereo".
Confirm the setting by pressing "OK"
- Press the "EXIT" key to close the TV menu.

Sound:

- To configure the sound settings of the LCD TV, press the yellow key  and use the cursor control key  to select the menu item "Sound via ...".
- For connection type **1**, use the - + key to select "Sound via Hifi".
The speakers of the LCD TV are muted.
The sound (AC3 or stereo sound) is rendered over the speakers of the Hifi set.
- For connection type **2**, use the - + key to select "Sound via surround".
The speakers of the LCD TV are used as the centre box. The sound (AC3 or stereo sound) is rendered over the speakers of the Hifi unit.

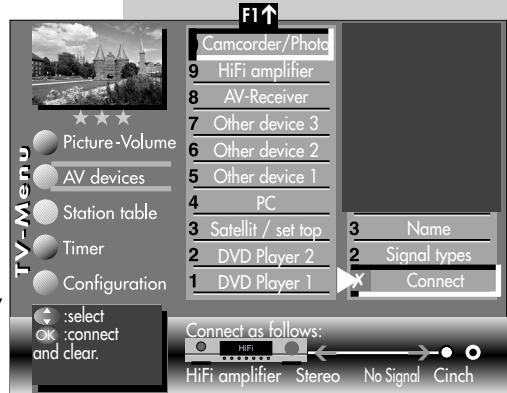
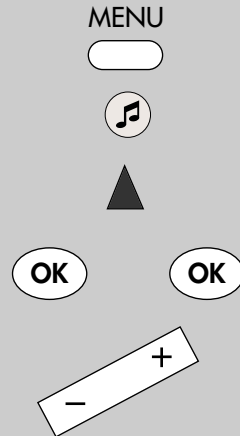

Opening the menu

AV



2

36. Copying between AV Devices Direct recording

If you wish to copy a recording from one of the AV devices connected to your TV set (such as a DVD player) to another connected AV device (such as a video recorder), you must do this by means of a direct recording operation. In this case, the signal arriving at one of the EURO sockets is redirected to the other EURO socket, from where it can be recorded.

Example: you have a DVD player and a video recorder connected to the EURO sockets of the TV set (see Section 25).

Programming a direct recording for copying:

- Press the "AV" key and use the corresponding numeric key to select the DVD player (playback device).
- Press the **F2** key.

Briefly pressing **F2** executes the function which is programmed for this function key (see Section 18.1, "Programming function keys"). Pressing and holding **F2** for about three seconds displays all functions available for this function key.

- Press **numeric key 0** to open the timer menu. The timer window displays the AV programme position (DVD player), the current date and a time window of two hours.
- If two hours is insufficient for the copying operation, use the numeric keys to enter a later end time.

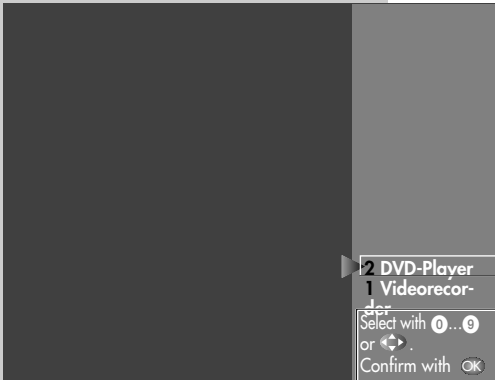

F2



0

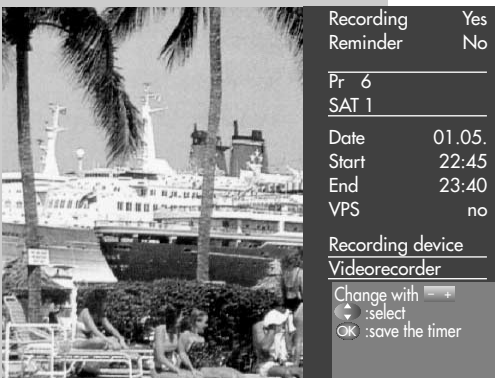

36. Copying between AV Devices

Direct recording

- Use the cursor control key ▼ to select the line "Recording device".
If only one such device exists, it is then displayed. If further recording devices exist, you can select the desired device with the aid of the - + key.
- Press the "OK" key to save the settings.
- On the playback device (in this example, the DVD player) start the film which is to be copied.
- On the recording device (in this example, the video recorder), select the AV programme position (in most cases AV1).
- On the recording device, start a direct recording by pressing the appropriate button (**REC** or **OTR**, etc.).

The TV set is now set up so that the signal coming from the playback device is connected directly to the recording device.

Opening the menu

MENU



2

7

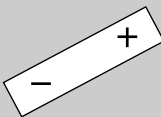
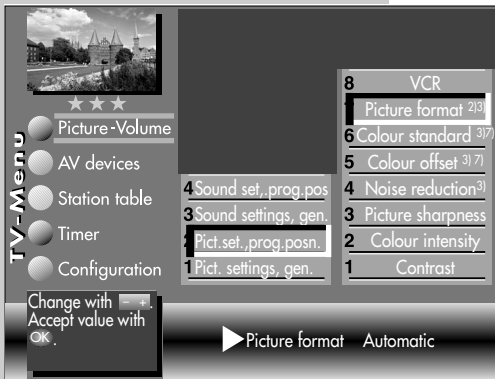

OK

EXIT



The number of subjects and sections depends on the selected scope of operation. Depending on the configuration of the TV set, the various menu items may be displayed in a different order and numbered differently.

3) See glossary for an explanation.

7) Available only for analogue stations!

37. Setting the Picture Format

Some of the following menu items are not available on a 2 ** menu.

Setting the picture format:

- Select the AV programme position which delivers the picture by pressing the "AV" key and then pressing the numeric key corresponding to the device you want to use.
- Press the "MENU" key. The TV menu appears on the screen.
- Press the blue key to open the menu "Picture and sound". The menu item "General picture settings" is preselected.
- Press **numeric key 2** to select the menu item "Pict. settings for Pr.". .
- Use the corresponding numeric key (in the example: **7**) to select the function "Picture format".
- Use the - + key to set the picture format setting to "Automatic".
- Press the "OK" key to save the new setting.
- Press the "EXIT" key to close the TV menu.

38. Glossary

Automatic zoom

When the automatic zoom function is active, programmes broadcast in "widescreen format" (such as those in the 16:9 format) are expanded to fill as much of the screen as possible.

If this function is inactive, the format of such programmes is not adjusted automatically.

AV programme position

AV devices have one or more connection sockets, depending on the model. The designations of these sockets are marked on the device (e.g. AV1).

On the AV device, you can select which socket you want to use. The selected socket is shown on the display of the AV device (e.g. A1 for socket AV1).

Code

The settings for the childlock function are protected by a four-digit code: you can enter any desired code, but you should note it for future use. If you have forgotten your code, please consult your local dealer.

Forced mono

It may happen that your TV set switches to stereo mode although the programme you are watching is not broadcast with stereo sound. This is normally due to the local reception conditions. If you set the selected programme position to "forced mono" all programmes received at this programme position are reproduced with mono sound.

Noise reduction

This function allows you to improve the picture quality of "snowy" pictures which result from poor reception conditions. Various levels of noise reduction can be selected and the settings can be made separately for each programme position.

38. Glossary

Panorama

The panorama function can be used to expand "normal" TV programmes broadcast in the 4:3 format to fill the full width of a 16:9 screen. This is done by expanding the picture width accordingly.

Picture position, vertical

With widescreen films, subtitles are sometimes transmitted in the black area at the bottom of the screen. You can move the picture upwards on the screen to ensure that these subtitles remain visible.

Standard values

The standard values are the settings (such as brightness, sound volume, colour, etc.) which are the same for all programme positions.

Spatial sound

This function can be used to create an artificial stereo effect for programmes with sound in mono.

Stereo wide

For stereo broadcasts, the distance between the speakers can be increased artificially in order to achieve a wider stereo effect.

SRS-WOW ²⁾

WOW is an audio system developed by SRS Labs, Inc. which provides a unique listening experience. The sound becomes fuller and the bass is deeper and more voluminous.

Activation of the WOW function allows you to hear a lot of spatial and environmental audio information which is lost in normal stereo mode.

In normal TV mode, the WOW function can be preselected by pressing the yellow key  and then switched on and off with the - + key.



Is a registered trade mark of SRS Labs, Inc.

2) Possible only on sets equipped with this function.

38. Glossary

The SRS WOW technology is used by Metz under a licence from SRS Labs, Inc.

Tone settings

The tone can be set to either "Normal" or "Speech". In the setting "Speech", the bass and treble components of the sound signal are set to make speech as easy to understand as possible. The setting "Normal" is recommended for music programmes.

VCR

The VCR function provides an optimal picture quality when playing back recordings from tape devices such as camcorders or video recorders.

Volume correction

The various stations broadcast their sound at different volumes. The TV set can automatically compensate for these differences in the volume. This function remains active even if the standard sound settings are recalled.

39. Technical Data

Mains voltage:

230-240 VAC, 50Hz

Antenna input:

75 Ohms, unbalanced DIN 45325

Channel coverage:

Standard channels 2 - 12, 21 - 69

Special channels S1 - S20, S21 - S41,

S42 ... S46 (Belgium channels OIR)

Power consumption

	Power consumption (to CENELEC / TC 59 X)	Music output power to DIN 45324 into 4Ω (at 1 kHz) (sinusoidal power) *) into 8Ω
Milos 26 Talio 26	ca. 102 W	2 x 12 W* (2 x 8 W)
Milos 26 SAT	ca. 107 W	2 x 12 W* (2 x 8 W)
Milos 32	ca. 120 W	2 x 20 W (2 x 12 W)
Milos 32 Sat	ca. 125 W	2 x 20 W (2 x 12 W)
Milos 32 S Talio 32 S	ca. 125 W	2 x 20 W (2 x 12 W)
Milos 37 S	ca. 170 W	2 x 20 W (2 x 12 W)

If a DVB-S module is installed, the power consumption increases by about 10 W.

Energy consumption per hour (Wh):

Multiply the power consumption in W by 1 hour

Stand-by: 1.7 W

39. Technical Data

Supported Signal Standards

Video HDMI

- a) 720x480i/p 60Hz RGB
- b) 720x480i/p 60Hz YCbCr 4:4:4 / 4:2:2
- c) 720x576i/p 50Hz RGB
- d) 720x576i/p 50Hz YCbCr 4:4:4 / 4:2:2
- e) 1280x720p 50/60Hz RGB
- f) 1280x720p 50/60Hz YCbCr 4:4:4 / 4:2:2
- g) 1920x1080i 50/60Hz RGB
- h) 1920x1080i 50/60Hz YCbCr 4:4:4 / 4:2:2
- i) 640x480p 60Hz RGB

Video DVI-D

- a) ... h) from Video HDMI, and
- 640x480p 60Hz RGB (DVI-D, analog)
- 800x600p 60Hz RGB (DVI-D, analog)
- 1024x768p 60Hz RGB (DVI-D, analog)
- 1366x768p 60Hz RGB (DVI-D, analog)
- 1280x720p 50/60Hz YCbCr analog
- 1920x1080i 50/60Hz YCbCr analog

Video Scart (RGB):

- 720x576i 50 Hz
- 720x480i 60 Hz

Video Scart (Y/C, FBAS) / Front AV:

- 720x576i 50 Hz PAL / SECAM
- 720x480i 60Hz NTSC

Video Component IN:

- 720x576i/p 50 Hz
- 720x480i/p 60 Hz
- 1280x720p 50/60Hz
- 1920x1080i 50/60Hz

Audio HDMI:

- Linear PCM Stereo 32 kHz
- Linear PCM Stereo 44,1 kHz
- Linear PCM Stereo 48 kHz

Audio S/PDIF:

- Linear PCM Stereo 32 kHz
- Linear PCM Stereo 44,1 kHz
- Linear PCM Stereo 48 kHz

39. Technical Data

Audio Scart / Front AV, Comp Audio, DVI Audio:
Analog Stereo

Audio Center IN:
Analog mono

39.1 Upgrade Kits

- **DVB-S digital upgrade kit 029 NM 1119**
For the reception of digital TV and radio stations broadcast via satellites. The DVB upgrade kit is installed in the TV set, which means that no external remote control is needed.
- **MD module 060 NM 1043 MPEG-Decoder**

Ask your local dealer about any further upgrade kits.

You can also find further information on our homepage: www.metz.de.

40. Inserting/Removing CA Modules

The LCD TV has two slots (C11 / C12) for CA modules at the top (card reader for smartcards or decoder cards).

To insert the CA module, open the lid on the top of the LCD TV and insert the CA module in one of the slots as shown in the pictures. Press the CA module down until the unlocking bar is lifted up.

Close the lid.

The LCD TV is now ready to decode the respective station.

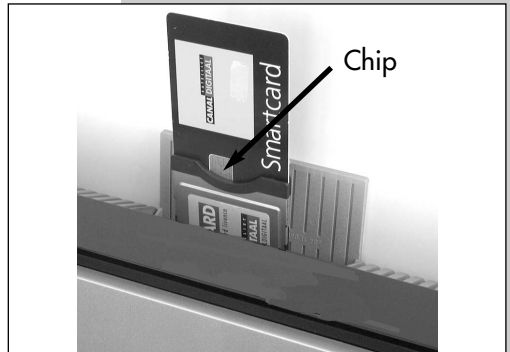

Front view



Back/top view (without lid)

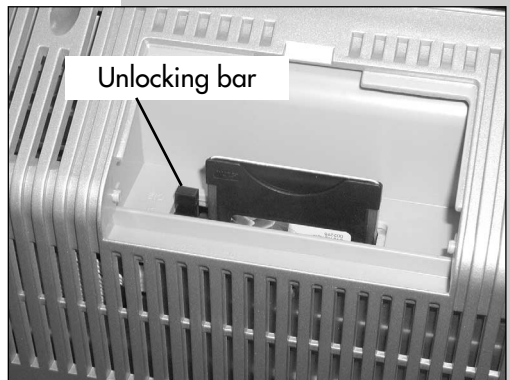

Back view (without lid)
with inserted module

41. Basic differences between analog terrestrial reception and DVB-T

Information for our dealers and interested customers.

In order to understand how the behaviour of DVB-T receivers differs from that of the analog terrestrial receivers used until now, two things are important: digital transmission and the simultaneous broadcasting network.

Digital transmission

A DVB transmitter does not transmit only a single programme, but a set of programmes – normally six to eight. The information for each programme – the picture, the sound and teletext – is converted into a digital format, i.e. into numerical values which are grouped together in packets. The packets of the various programmes are then transmitted sequentially in a so-called transport stream.

Further information which permits the receiver to detect and correct any errors which occur during transmission is added to this transport stream.

Example:

If the information 0 or 1 is to be transmitted, the 0 could be encoded as 000 and the 1 as 111. If one of the three digits numbers is falsified during transmission, i.e. the receiver receives, for example, 010 instead of 000, the receiver can decide that the presence of at least two zeros indicates that the intended information value was 0 and, correspondingly, that at least two ones indicates the information 1.

If two of the numbers in a block are changed, the receiver can detect that an error has occurred, but any attempt to correct this would have the wrong result.

Example:

If the information 0 is encoded as 000 and is received as 101, the receiver would assume that this should have been 111 and will then decode it, incorrectly, as 1.

To sum up:

several programmes are transmitted by a single transmitter in the form of digital packets. Additional information is transmitted to permit complete correction of a certain number of transmission errors.

Simultaneous broadcasting network

For DVB-T, the programmes are not transmitted on a modulated carrier frequency; instead, one channel with a width of 8 MHz contains 8,192 individual carrier frequencies.

Some of the signals reaching the receiver come directly from the transmitter, others are signals which have been reflected from obstacles in the vicinity and some are even those transmitted by other transmitters. Normally, these signals reinforce each other. In extreme cases, however, if they are out of phase and have the same amplitude, the signals can cancel each other out:

41. Basic differences between analog terrestrial reception and DVB-T

Addition

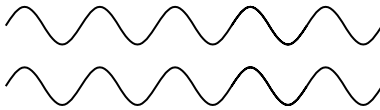

Cancellation

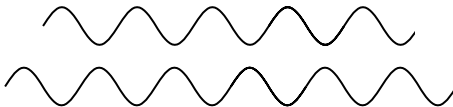

In most cases, only a few of the 8,192 carrier frequencies will be fully cancelled out and the information which is lost can be reconstructed by the error-correction function of the receiver. Reception becomes impossible only if very strong reflections cause the loss of too many carrier frequencies.

The phase relationship between two signals depends on the path taken by these signals on their way to the receiver.

If a rooftop antenna is used, almost all of the signals reach the receiver by the same path.

If an indoor antenna is used, the signals reaching the receiver may have been reflected from

- objects outside the building,
- objects such as thermally insulated windows (coated with metal films),
- reinforced-concrete parts of the building,
- persons in the vicinity or
- the furnishings of the room.

The signals may also have come from a different transmitter.

In such cases, the reception quality depends not only on the actual signal strength, but also on how many carrier frequencies are cancelled out.

Such problems can often be corrected by adjusting the position and the alignment of the antenna. In general, moving the antenna a few centimetres to one side, or tilting or turning the antenna, can improve reception far more than the use of an additional antenna amplifier.

👉 Simply moving the antenna a few centimetres to one side can often cause the signals to be added together instead of cancelling each other out.

Calling the menu

MENU



5

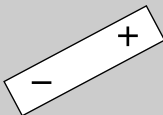
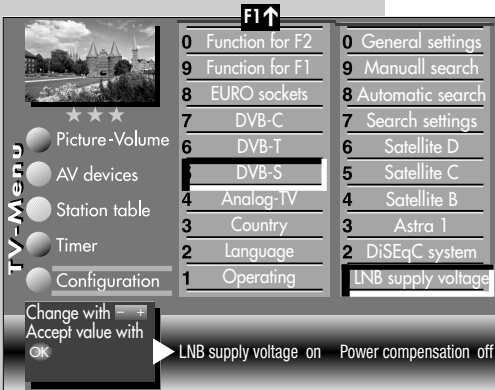

OK

EXIT



The number of subjects and sections depends on the selected scope of operation. Depending on the configuration of the TV set, the various menu items may be displayed in a different order and numbered differently.

A1. Set-up of satellite system LNB supply voltage

i The settings of the satellite antenna system must be entered in the menu "Configuration" so that the TV set knows them.

These settings should always be made in the order in which they are shown in the right-hand column of the menu, starting at the bottom, i.e. LNB supply voltage, DiSEqC system, etc..

LNB supply voltage

The LNB voltages for selection of the polarisation (horizontal H = 18V, vertical V = 14V) are already set and do not normally need to be changed.

If the cable to the satellite antenna is very long, the voltages reaching the LNB may be too low. In such cases, the voltages can be increased by 1 V by activating the line-compensation function.

If any changes should be necessary, they can be made as follows.

Changing the settings

- Press the MENU key to open the TV menu.
- Press the red key  to open the menu "Configuration".
- Press the appropriate numeric key (in this example **5**) to select "DVB-S".
- Press the OK key and, in the setting window, use the - + key to switch the LNB supply voltage on or off.
- Press the Ok key to confirm the new setting.
- Press the EXIT key to close the TV menu.

 If the TV set is connected to a community antenna, the LNB supply voltage must always be set to "Off".

A1.1 Set-up of satellite system DiSEqC system

Calling the menu



"DiSEqC" makes it possible to control the satellite antenna digitally via the existing antenna cable and is a prerequisite for the reception of signals from more than two satellites (e.g.

i Astra, Eutelsat, Hotbird).

If you wish to receive signals from at least three satellites (e.g. ASTRA 19.2°, Eutelsat 16°, Hotbird 13°) the antenna system can be controlled only with the aid of "DiSEqC".

 **This menu item is not available in a 2** menu.**

Switching DiSEqC on and off

- Press the MENU key to open the TV menu.
- Press the red key  to open the menu "Configuration".
- Press the appropriate numeric key (in this example  to select "DVB-S".
- Use the cursor control key to select "DiSEqC system" and press the OK key to confirm the selection. The cursor is now located in front of "DiSEqC system" in the setting window.
- Use the  + to select "Yes" or "No".
- Press the OK key to confirm the new setting.
- Press the EXIT key to close the TV menu.

MENU

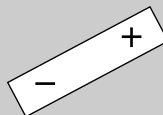
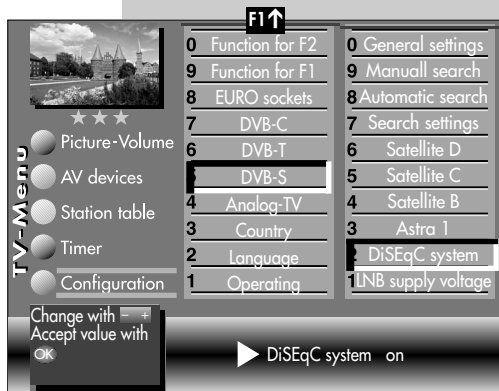

EXIT



The number of subjects and sections depends on the selected scope of operation. Depending on the configuration of the TV set, the various menu items may be displayed in a different order and numbered differently.

Calling the menu

MENU

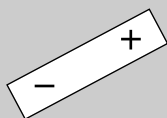
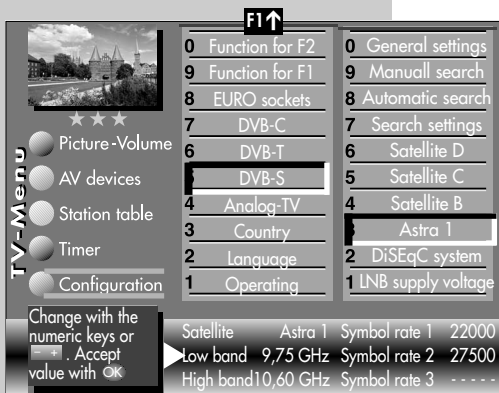

EXIT



A1.2 Set-up of satellite system Selecting satellites

You can set up to four satellites in the menu "Configuration". No satellite is set in the factory.

The LNB frequency is used to switch between the high and low frequency bands. The default frequencies **Low band 9.75 GHz** and **High band 10.60 GHz** are set in the factory.

Selecting satellites

- Press the MENU key to open the TV menu.
- Press the red key to open the menu "Configuration".
- Press the appropriate numeric key (in this example) to select "DVB-S".
- Press the appropriate numeric key (in this example) to select "Satellite A".
- Use the **- +** key to select the desired satellite. The most common satellites are displayed one after the other, together with the symbol rates for each one. Depending on the satellite, it may be necessary to set additional **symbol rates** manually if the selected satellite uses different symbol rates and you wish to find the related transponders in an automatic station search.

- Use the cursor control key to select "Low band" or "High band". The settings depend on the components installed in the satellite antenna. For the correct settings, please consult the data sheet or the label of the LNB(s) being used.
- Press the OK key to confirm the new settings.
- Press the EXIT key to close the TV menu.

The number of subjects and sections depends on the selected scope of operation. Depending on the configuration of the TV set, the various menu items may be displayed in a different order and numbered differently.

A2. Setting the stations

Search settings

Calling the menu

Before executing a DVB station search, you must make the appropriate search settings.

Depending on the features installed in the TV set and your personal requirements, you can make the following settings:

All = search for all stations on the selected satellite.

FTA only = search only for unencrypted (free-to-air) stations on the selected satellite.

FTA (CI) = search for all FTA stations and stations which can be received with the CI module.

The menu item "FTA (CI)" is available only if a CI module has been installed and a CA module is plugged into it.

Making the search settings

- Press the MENU key to open the TV menu.
- Press the red key  to open the menu "Configuration".
- Press the appropriate numeric key (in this example **5**) to select "DVB-S".
- Press the appropriate numeric key (in this example **7**) to select "Search settings".
- Use the - + key to select the desired setting.
- Press the Ok key to confirm the new setting.
- Press the EXIT key to close the TV menu.

MENU



5

7

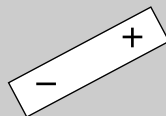
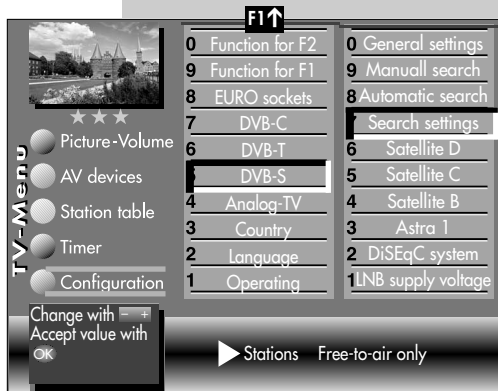

EXIT



The number of subjects and sections depends on the selected scope of operation. Depending on the configuration of the TV set, the various menu items may be displayed in a different order and numbered differently.

Calling the menu

A2. Setting the stations Automatic search

DVB-S station search

The DVB-S station search scans the entire reception band for **TV** and **radio stations** and stores them in separate TV and radio station tables. For details of the DVB radio mode, see Section 29 in the operating instructions for the TV set.

If you are not satisfied with the order in which the stations are stored, you can move stations to other positions in the table or delete them. For further details, see Section 24, "Sorting stations" in the operating instructions for the TV set.

 **The station search will function correctly only if the LNB frequencies have been set and stored correctly.**

MENU



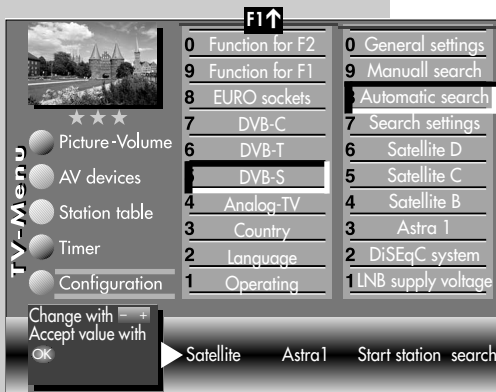

5

8



Executing the automatic station search

- Press the MENU key to open the TV menu.
- Press the red key  to open the menu "Configuration".
- Press the appropriate numeric key (in this example **5**) to select "DVB-S".
- Press the appropriate numeric key (in this example **8**) to select "Automatic search".
- In the setting window, use the - + key to select the desired satellite (if several are available; see Section 1.2 of the operating instructions for the TV set).

- Use the cursor control key  to move to the menu line "Start station search".
- Press the OK key to start the station search.

The TV set searches for the specified stations and places them in a station table, which is then displayed.

If desired, you can sort or move stations to other positions in the table or delete unwanted stations. For details, see Section 24 of the operating instructions for the TV set..

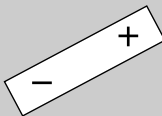

OK

EXIT



The number of subjects and sections depends on the selected scope of operation. Depending on the configuration of the TV set, the various menu items may be displayed in a different order and numbered differently.

A2. Setting the stations

Manual search

Calling the menu

For the manual search, you must know the frequency, the symbol rate and the polarisation of the station for which you want to search.

Executing the manual search

- Press the MENU key to open the TV menu.
- Press the red key  to open the menu "Configuration"
- Press the appropriate numeric key (in this example **5**) to select "DVB-S".
- The cursor is located on the line "LNB supply voltage".
- Press the appropriate numeric key (in this example **9**) to select "Manual search".
- The cursor then moves to "Satellite". If more than one satellite is available, use the **- +** key to select the desired satellite.
- In the setting window, use the cursor control key **▶** to select the menu line "Frequency".
- Use the numeric keys or the **- +** key to set the frequency.
- In the setting window, use the cursor control key **▼** to select the line "Polarisation" and use the **- +** key to select "H=Horizontal" or "V=Vertical".
- In the setting window, use the cursor control key **◀** to select the line "Symbol rates" and enter the symbol rate with the numeric keys.
- In the setting window, use the cursor control key **▼** to select the line "Start station search" and press the OK key to start the search. The station is placed in the station table. If desired, you can sort or move stations to other positions in the table or delete unwanted stations. For details, see Section 24 of the operating instructions for the TV set.

MENU



5

9

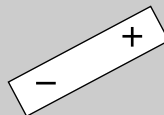
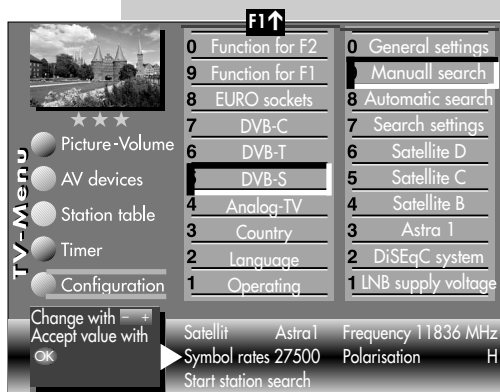

OK

The number of subjects and sections depends on the selected scope of operation. Depending on the configuration of the TV set, the various menu items may be displayed in a different order and numbered differently.

Calling the menu

MENU



5

0

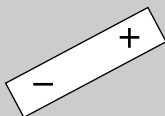
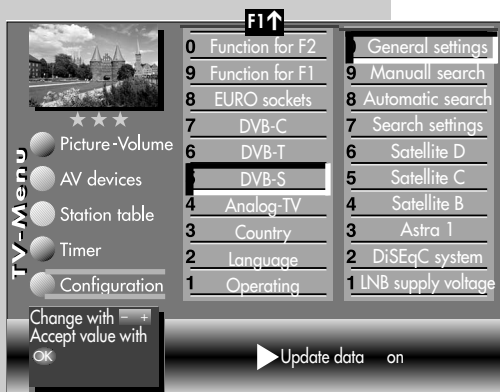

OK

EXIT



The number of subjects and sections depends on the selected scope of operation. Depending on the configuration of the TV set, the various menu items may be displayed in a different order and numbered differently.

A2. Setting the stations Updating the data

With the menu item, "General settings", you can specify whether or not the data are to be saved in the non-volatile memory of the TV set when transmission parameters are changed.

This update function applies to stations which use different transmission parameters at different times of the day, such as when they transmit regional programmes.

Setting the data update function

- Press the MENU key to open the TV menu.
- Press the red key  to open the menu "Configuration".
- Press the appropriate numeric key (in this example **5**) to select "DVB-S".
- The cursor is located on the line "LNB supply voltage".
- Press the appropriate numeric key (in this example **0**) to select "General settings".
- In the setting window, use the - + key to set "Update data" to "On".
- Press the OK key to confirm the new setting.
- Press the EXIT key to close the TV menu.

Problem	Possible cause	Remedy
TV set does not react to commands from the remote control	<ul style="list-style-type: none"> • No line of sight between the remote control and the TV set. • Sunlight is shining directly on the infrared window of the TV set. • Batteries of the remote control are exhausted. • TV set has been switched off with the main power switch. • Fault in the internal processor. 	<ul style="list-style-type: none"> • Remove any obstacles between the units. • Prevent sunlight from shining on the set. • Replace the batteries. • Switch on the TV set with the main power switch. • Switch off the TV set with the main power switch, wait a few seconds and then switch it on again.
The message "Enter code" is displayed when the TV set is switched on.	<ul style="list-style-type: none"> • The childlock is active and was programmed to disable all stations. 	<ul style="list-style-type: none"> • Enter the code you used when programming the childlock.
The TV set will not switch to a selected programme position. A teddy bear is displayed instead.	<ul style="list-style-type: none"> • The childlock is active and was programmed so that only the stations shown in the list beside the teddy bear may be selected. 	<ul style="list-style-type: none"> • Enter the code you used when programming the childlock.
You have switched off the TV set with the Ⓢ key, but the green LED remains on.	<ul style="list-style-type: none"> • EPG data are currently being collected from the programmed EPG station. 	<ul style="list-style-type: none"> • None. When all data have been collected, the TV set will switch itself off automatically.
Direct recording of an analogue terrestrial station (received via roof antenna or cable) with Data Logic does not work.	<ul style="list-style-type: none"> • The Data Logic video recorder is not connected to the roof antenna or cable outlet with a suitable cable. 	<ul style="list-style-type: none"> • Connect the Data Logic video recorder to the roof antenna or cable outlet with a suitable cable.

Problem	Possible cause	Remedy
<p>General problems with an external AV device connected to the TV set.</p>	<ul style="list-style-type: none"> • The AV device has not been registered in the TV set. 	<ul style="list-style-type: none"> • Open the menu "AV devices", select the device with the cursor, set the signal types (OUT/IN) correctly and press the "OK" key. Make sure that you connect the AV device as shown in the connection diagram.
<p>Data Logic does not work.</p>	<ul style="list-style-type: none"> • The Data Logic video recorder with data transfer has not been registered correctly. • The Scart cable does not have all pins connected through. 	<ul style="list-style-type: none"> • Open the menu "AV devices" and register the Data Logic video recorder as video recorder 1 with "Data Logic On". • Use a Scart cable in which all pins are connected through.
<p>A film in 16:9 format is played back from an AV device, but is displayed in 4:3 format.</p>	<ul style="list-style-type: none"> • The picture format for this programme position has not been set correctly in the TV menu. 	<ul style="list-style-type: none"> • Select the AV programme position and set the picture format to 16:9 or "Automatic" (see Section 37).
<p>The menu of a connected AV device (such as a DVD player) is not visible on the TV screen.</p>	<ul style="list-style-type: none"> • The AV device has been registered in the TV menu with the signal type "Composite video". 	<ul style="list-style-type: none"> • Register the AV device with the signal type "RGB" (see page 68).

Index

Automatic station search	56-60
Automatic zoom	30
AV devices, connecting/registering	64
AV devices, removing	70
AV programme position	16
AV playback, devices with switching voltage .	15
AV playback, devices without switching voltage.	16
Batteries for the remote control.	6
Brightness	7,18
Camcorder, connecting.	64,80
Childlock	31
Childlock, activating	31
Childlock, deactivating	32
Childlock, permitted programmes.	32
Cleaning	79
Code for childlock.	32
Colour standard	29,57
Connections on front and rear of set	80,81
Copying recordings	84
Country	52
DataLogic video recorder	65
Decoder (D-Box), connecting	64
Direct recording (OTR)	41
Double font size	13
DVD player, connecting.	64
DVD player, removing.	70
Electronic Programme Guide = EPG	46
EURO sockets	15,81
External devices (playback)	15
External devices, connecting.	64,81
Font size, double	13
Forced mono	27
Freeze frame	7
Function keys.	7,44
Glossary	87
Headphones	78,80
Help	10
HiFi output	72

Index

Info (Information)	10
Initial programme position	71
Interests (see EPG).	50
Language for TV menu	52
Marks in Teletext, clearing	14
Marks in Teletext, overview	12
Marks in Teletext, scrolling by	13
Marks in Teletext, setting	13
Menu language	52
Menu, menu control	11
Multiple pages, sub-pages.	12
Noise reduction	18,20
Off time	34
On time	34
Operating mode.	8
Panorama	19,42
Picture format.	42
Picture position	43
Picture quality from video recorder.	17
Picture settings	8,18,20,21
Picture sharpness	18
Playing back from external devices.	15,16,84
Premiere decoder - see AV device	
Programme guide	46
Programme switching for AV devices	9
Radio mode with DVB	75
Reception type	53
Recording with the EPG.	51
Reminder	33,50
Riddle key	13
Signal type (Euro sockets)	67-69
Sleep timer.	34
Sound 1, Sound 2.	77
Sound corrections.	28
Sound effects	22
Sound settings	8,22
Spatial sound (see sound settings)	22
SRS-WOW	23

Index

Standard picture settings	18
Standard sound settings	24
Station logo	61
Station search, automatic	58,60
Station search, manual.	59,61
Station selection	9
Station table.	15
Stations, moving, copying and deleting	63
Stations, sorting	63
Stereo wide	22
Summer time (see time settings)	35
Switching off	8
Switching on	8
Switching voltage, devices with	15
Switching voltage, devices without	16
Thunderstorms	5
Timer control	34
Timer, setting manually	35
Tone settings (see Sound settings)	26
TV menu	11
TV standard	57
VCR function	17
Video recorder, connecting	64
Video recorder, picture quality	17
Teletext	12
Teletext, clearing marks	14
Teletext, font size.	13
Teletext, overview of marks	14
Teletext, scrolling by marks	13
Teletext, setting marks	13
Volume correction.	25
Volume correction, automatic.	24
Winter time	35
Zoom	19,42

Connect a PC

To connect a PC to the LCD TV, you must first register the PC with the LCD TV; see Chapter 25 "Registering AV Devices".

Set the signal type for the PC to DVI-A (analogue with VGA cable) or DVI-D (digital with DVI cable), depending on the connection type. Use a suitable connection cable to connect the PC to the LCD TV.

Power on the LCD TV, press "AV", and select the "PC" connection with the respective number key.

Power up the PC and wait. Usually, the LCD TV will recognise the PC and display the image. If possible, select a resolution of 1366 x 768 pixels @ 60 Hz.

If these steps do not result in a satisfactory display of the PC image, proceed as follows:

1. Before you connect the PC to the LCD TV, set the resolution to 1024 x 768 pixels and the refresh rate to 60 Hz. For graphics cards with two outputs (e.g., VGA and DVI), set the operating mode to "clone" to display the same image on both outputs.
2. Install the latest graphics-cards driver. Most graphics cards have an ATI or nVidia graphics chip.
For all ATI-based graphics cards, the drivers can be downloaded from www.ati.com (often "catalyst drivers").
The latest drivers for all nVidia-based graphics cards are available at www.nvidia.com.
3. If you use the analogue VGA graphics-card output, use a fully wired 15-pin VGA cable in order to ensure that the information exchange between the PC and the LCD TV works (DDC)



- ① Service Centre
- ② Training Centre
- ③ Administration and development
- ④ Storage/Dispatch
- ⑤ Mecablitz production
- ⑥ TV production
- ⑦ Plastics technology

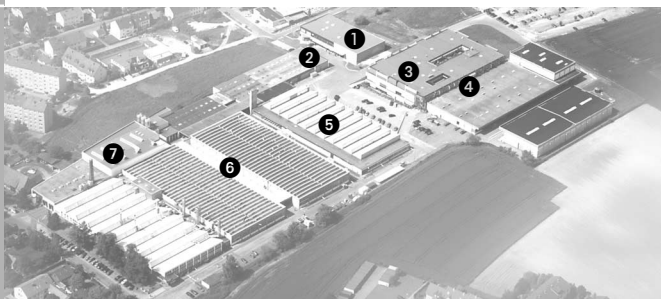

Metz - Werke GmbH & Co. KG - Zirndorf near Nürnberg

Core competence in the areas of electronics and plastics technology to form the basis of the excellent reputation of the Metz Werke that has been built up throughout the world over a period of many decades.

Metz offers quality made in Germany:
Consumer electronics, mecablitz flash units,
plastics technology and industrial electronics.

Metz-Werke GmbH & Co. KG
Postfach 1267, D-90506 Zirndorf

Fon: +49 911 - 97060
Fax: +49 911 - 9706340

www.metz.de
info@metz.de

Errors excepted. Subject to changes.

© Printed in Germany

Metz - always first class.

Free Manuals Download Website

<http://myh66.com>

<http://usermanuals.us>

<http://www.somanuals.com>

<http://www.4manuals.cc>

<http://www.manual-lib.com>

<http://www.404manual.com>

<http://www.luxmanual.com>

<http://aubethermostatmanual.com>

Golf course search by state

<http://golfingnear.com>

Email search by domain

<http://emailbydomain.com>

Auto manuals search

<http://auto.somanuals.com>

TV manuals search

<http://tv.somanuals.com>