

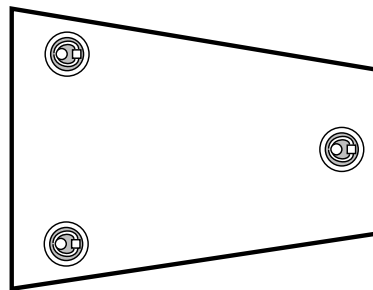

# Operating Instructions

## MSL-4

Self-Powered Loudspeaker System



Top

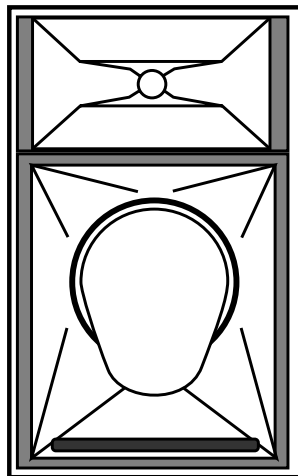

Front

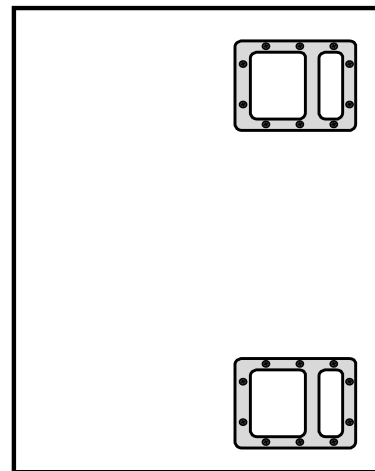

Side

Copyright © 1999  
Meyer Sound Laboratories, Inc.  
All rights reserved.  
Part # 05.031.008.01 Rev C

**Keep these important operating instructions.**



## Safety Summary



### English

- To reduce the risk of electric shock, disconnect the loudspeaker from the AC mains before installing audio cable. Reconnect the power cord only after making all signal connections.
- Connect the loudspeaker to a two-pole, three wire grounding mains receptacle. The receptacle must be connected to a fuse or circuit breaker. Connection to any other type of receptacle poses a shock hazard and may violate local electrical codes.
- Do not install the loudspeaker in wet or humid locations without using weather protection equipment from Meyer Sound.
- Do not allow water or any foreign object to get inside the loudspeaker. Do not put objects containing liquid on, or near, the unit.
- To reduce the risk of overheating the loudspeaker, avoid exposing it to direct sunlight. Do not install the unit near heat-emitting appliances, such as a room heater or stove.
- This loudspeaker contains potentially hazardous voltages. Do not attempt to disassemble the unit. The unit contains no user-serviceable parts. Repairs should be performed

### Français

- Pour réduire le risque d'électrocution, débranchez la prise principale de l'haut-parleur, avant d'installer le câble d'interface allant à l'audio. Ne rebranchez le bloc d'alimentation qu'après avoir effectué toutes les connexions.
- Branchez l'haut-parleur dans une prise de courant à 3 dérivations (deux pôles et la terre). Cette prise doit être munie d'une protection adéquate (fusible ou coupe-circuit). Le branchement dans tout autre genre de prise pourrait entraîner un risque d'électrocution et peut constituer une infraction à la réglementation locale concernant les installations électriques.
- Ne pas installer l'haut-parleur dans un endroit où il y a de l'eau ou une humidité excessive.
- Ne pas laisser de l'eau ou tout objet pénétrer dans l'haut-parleur. Ne pas placer de récipients contenant un liquide sur cet appareil, ni à proximité de celui-ci.
- Pour éviter une surchauffe de l'haut-parleur, conservez-la à l'abri du soleil. Ne pas installer à proximité d'appareils dégageant de la chaleur tels que radiateurs ou appareils de chauffage.
- Ce haut-parleur contient des circuits haute tension présentant un danger. Ne jamais essayer de le démonter. Il n'y a aucun composant qui puisse être réparé par l'utilisateur. Toutes les réparations doivent être effectuées par du personnel qualifié et agréé par le constructeur.

### Deutsch

- Um die Gefahr eines elektrischen Schlages auf ein Minimum zu reduzieren, den Lautsprecher vom Stromnetz trennen, bevor ggf. ein Audio-Schnittstellensignalkabel angeschlossen wird. Das Netzkabel erst nach Herstellung aller Signalverbindungen wieder einstecken.
- Der Lautsprecher an eine geerdete zweipolige Dreiphasen-Netzsteckdose anschließen. Die Steckdose muß mit einem geeigneten Abzweigschutz (Sicherung oder Leistungsschalter) verbunden sein. Der Anschluß der unterbrechungsfreien Stromversorgung an einen anderen Steckdosentyp kann zu Stromschlägen führen und gegen die örtlichen Vorschriften verstoßen.
- Der Lautsprecher nicht an einem Ort aufstellen, an dem sie mit Wasser oder übermäßig hoher Luftfeuchtigkeit in Berührung kommen könnte.
- Darauf achten, daß weder Wasser noch Fremdkörper in das Innere den Lautsprecher eindringen. Keine Objekte, die Flüssigkeit enthalten, auf oder neben die unterbrechungsfreie Stromversorgung stellen.
- Um ein Überhitzen dem Lautsprecher zu verhindern, das Gerät vor direkter Sonneneinstrahlung fernhalten und nicht in der Nähe von wärmeabstrahlenden Haushaltsgeräten (z.B. Heizgerät oder Herd) aufstellen.
- Im Inneren diesem Lautsprecher herrschen potentiell gefährliche Spannungen. Nicht versuchen, das Gerät zu öffnen. Es enthält keine vom Benutzer reparierbaren Teile. Reparaturen dürfen nur von ausgebildetem Kundendienstpersonal durchgeführt werden.

### Español

- Para reducir el riesgo de descarga eléctrica, desconecte de la red el altoparlante antes de instalar el cable de señalización de interfaz de la segnale. Vuelva a conectar el conductor flexible de alimentación solamente una vez efectuadas todas las interconexiones de señalización.
- Conecte el altoparlante a un tomacorriente bipolar y trifilar con neutro de puesta a tierra. El tomacorriente debe estar conectado a la protección de derivación apropiada (ya sea un fusible o un disyuntor). La conexión a cualquier otro tipo de tomacorriente puede constituir peligro de descarga eléctrica y violar los códigos eléctricos locales.
- No instale el altoparlante en lugares donde haya agua o humedad excesiva.
- No deje que en el altoparlante entre agua ni ningún objeto extraño. No ponga objetos con líquidos encima de la unidad ni cerca de ella.
- Para reducir el riesgo de sobrecalentamiento, no exponga la unidad a los rayos directos del sol ni la instale cerca de artefactos que emiten calor, como estufas o cocinas.
- Este altoparlante contiene niveles de voltaje peligrosos en potencia. No intente desarmar la unidad, pues no contiene piezas que puedan ser reparadas por el usuario. Las reparaciones deben efectuarse únicamente por parte del personal de mantenimiento capacitado en la fábrica.

## Contents

Safety Summary ..... 2 Introduction..... 4 AC Power ..... 4 Audio Input ..... 6 Amplification and Protection Circuitry..... 6	Rigging ..... 8 Measurement and System Integration Tools ..... 8 Complete Systems ..... 9 Driver Troubleshooting ..... 12 Array Design ..... 13 Specifications ..... 14 Controls and Connectors ..... 15
---	--

## Symbols Used

These symbols indicate important safety or operating features in this booklet and on the chassis.



Dangerous voltages: risk of electric shock	Important operating instructions	Frame or chassis	Protective earth ground
Pour indiquer les risques résultant de tensions dangereuses	Pour indiquer important instructions	Masse, châssis	Terre de protection
Zu die gefahren von gefährliche spanning zeigen	Zu wichtige betriebsanweisung und unterhaltsanweisung zeigen	Rahmen oder chassis	Die schutzerde
Para indicar azares provengo de peligroso voltajes	Para indicar importante funcionar y mantenimiento instrucciones	Armadura o chassis	Tierra proteccionista

Declaration of Conformity According to ISO/IEC Guide and EN 45014

The Manufacturer:

Meyer Sound Laboratories, Inc.  
 2832 San Pablo Avenue  
 Berkeley, California 94702-2204, USA

Declares that the product:

MSL-4  
 Product Options: All

Conforms to the following Product Specifications:

Safety: EN 60065: 1994  
 EMC: EN 55022: 1987 - Class A  
 IEC 801-2: 1984 - 8 kV  
 IEC 801-3: 1984 - 3 V/m  
 IEC 801-4: 1984 - 0.5 kV Signal

The product herewith complies with the requirements of the Low Voltage Directive 73 / 23 / EEC and the EMC Directive 89 / 336 / EEC.

**Office of Quality Manager**  
**Berkeley, California USA**  
**April 27, 1999**

Operating temperature:	0°C to + 45°C
Nonoperating temperature:	< -40° C or > +75° C
Humidity:	to 95% at 35° C
Operating Altitude:	to 4600 m (15,000 ft)
Nonoperating altitude:	to 6300 m (25,000 ft)
Shock:	30g 11 msec half-sine on each of 6 sides
Vibration:	10 Hz to 55 Hz (0.010m)

Made by Meyer Sound, Berkeley, CA, USA  
 European Office:  
 Meyer Sound Germany GmbH  
 Carl Zeiss Strasse 13  
 56751 Polch, Germany



**UL LISTED 3K59 C**  
**COMMERCIAL AUDIO SYSTEM**

# Introduction

The **MSL-4 self-powered loudspeaker system** is ideal for large venues requiring long throw distances and precise coverage, but can also be used effectively in smaller applications. Its high-Q (narrow coverage) horn has a consistent beam width across its entire frequency range, enabling efficient array design that maximizes coverage and SPL for a given array size.

The MSL-4 contains independent amplifier and control electronics for one 12" low frequency cone driver (in a horn-loaded vented enclosure) and one high frequency horn driver (2" throat, 4" diaphragm) in a compact trapezoidal cabinet. This integrated design provides excellent performance, durability, and reliability, eliminates amplifier racks, and simplifies setup and installation.

The MSL-4 matches well with the Meyer Sound DS-4 self-powered mid/bass loudspeaker, the PSW-2 and 650-P self-powered subwoofers, and also performs efficiently with the PSW-4. The MSL-4 can be used as a full-range or mid-hi speaker and has the following acoustical specifications:

Frequency Response	±4 dB 65 Hz – 18 kHz
Phase Response	±30° 450 Hz – 10 kHz
Coverage	40° H x 35° V
Dynamic Range	> 110 dB

The MSL-4 can be equipped to operate with the **Remote Monitoring System™** (RMS) interface network and software application. RMS displays signal and power levels, driver and cooling fan status, limiter activity, and amplifier temperature for all speakers in the network on a Windows-based PC. Contact Meyer Sound for more information about RMS.

## AC Power

When AC power is applied to the MSL-4, the **Intelligent AC™** supply automatically selects the correct operating voltage, allowing the MSL-4 to be used in the US, Europe, or Japan without manually setting a voltage switch. The Intelligent AC power supply also protects the MSL-4 by performing surge suppression for high voltage transients (up to 275V), minimizing inrush current, and filtering EMI. The MSL-4 uses a NEMA L6-20P or IEC 309 male power inlet and satisfies UL, CSA, and EC safety standards.

NOTE: Continuous voltages higher than 275V may damage the unit!

## Voltage Requirements

The MSL-4 operates safely and without audio discontinuity if the AC voltage stays within the ranges 85–134V or 165–264V,

at 50 or 60Hz. Immediately after applying AC power, the green **Active** LED on the user panel illuminates and the proper operating voltage is automatically selected, but the system is muted. During the next three seconds, the primary fan turns on, the main power supply slowly ramps on, and the system is enabled to pass audio signals.

**TROUBLESHOOTING NOTE:** If the Active LED does not illuminate or the system does not respond to audio input after ten seconds, remove AC power to avoid possible damage to the unit. Experienced electronics technicians with access to a test bench can verify proper operation for the power supply and amplifier system with The Meyer Sound Self-Powered Series MP-2 and MP-4 Field Verification Procedure (part # 17.022.066.01; contact Meyer Sound to receive this document). All other users should contact Meyer Sound or an authorized Meyer Sound service center.

If the voltage decreases below the lower bound of either operating range (known as a *brown-out* period), the supply uses current from its storage circuits and continues to function briefly. The unit turns off if the voltage does not increase above the threshold before the storage circuits are depleted. The length of time that the MSL-4 continues to operate during brown-out depends on how low the voltage drops and the audio source level during this period.

If the voltage fluctuates *within* either operating range, automatic tap selection stabilizes the internal operating voltage. This tap selection is instantaneous and there are no audible artifacts. If the voltage increases above the upper bound of either range, the power supply turns off rapidly, preventing damage to the unit.

If the MSL-4 shuts down due to either low or high voltage, the power supply automatically turns on after three seconds if the voltage has returned to either normal operating range. If the MSL-4 does not turn back on after ten seconds, remove AC power and refer to the TROUBLESHOOTING NOTE above.

## Current Requirements

The MSL-4 presents a dynamic load to the AC mains which causes the amount of current to fluctuate between quiet and loud operating levels. Since different types of cables and circuit breakers heat up (and trip) at varying rates, it is essential to understand the types of current ratings and how they correspond to circuit breaker and cable specifications.

The **maximum continuous RMS** current is the maximum RMS current over a duration of at least 10 seconds. It is used to calculate the temperature increase in cables, which is used to select cables that conform to electrical code standards. It is also

used to select the rating for slow-reacting thermal breakers.

The **maximum burst RMS** current is the maximum RMS current over a one second duration. It is used to select the rating for most magnetic breakers.

The **maximum instantaneous peak current during burst** is used to select the rating for fast-reacting magnetic breakers and to calculate the peak voltage drop in long AC cables according to the formula

$$V_{pk\_drop} = I_{pk} \times R_{total\ cable}$$

Use the table below as a guide to select cables and circuit breakers with appropriate ratings for your operating voltage.

M SL-4 Current Ratings			
	115V	230V	100V
Max. Continuous RMS	8A	4A	10A
Max. Burst RMS	15A	8A	18A
Max. Peak During Burst	22A	11A	25A

The minimum electrical service amperage required by a system of Meyer speakers is the sum of their **maximum continuous RMS** currents. We recommend allowing an additional 30% above the minimum amperage to prevent peak voltage drops at the service entry.

**TROUBLESHOOTING NOTE:** In the unlikely case that the circuit breakers trip (the white center buttons pop out), do not reset the breakers! Contact Meyer Sound for repair information.

## Safety Issues

Pay close attention to these important electrical and safety issues.

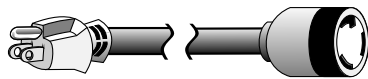

Use a power cord adapter to drive the MSL-4 from a standard 3-prong outlet (NEMA 5-15R; 125 V max).

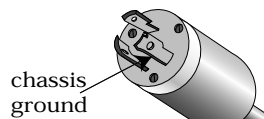

The MSL-4 requires a grounded outlet. Always use a

grounding adapter when connecting to ungrounded outlets.

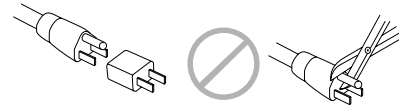

Do not use a ground-lifting adapter or cut the AC cable ground pin.



Keep all liquids away from the MSL-4 to avoid hazards from electrical shock.

Do not operate the unit if the power cables are frayed or broken.



Tie-wrap anchors on the amplifier chassis provide strain relief for the power and signal cables. Insert the plastic tie-wraps through the anchors and wrap them around the cables.

## Power Connector Wiring

Use the following AC cable wiring diagram to create international or special-purpose power connectors:

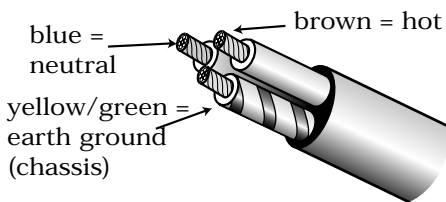

AC cable color code

If the colors referred to in the diagram don't correspond to the terminals in your plug, use the following guidelines:

- Connect the blue wire to the terminal marked with an *N* or colored black.
- Connect the brown wire to the terminal marked with an *L* or colored red.
- Connect the green and yellow wire to the terminal marked with an *E* (or  $\oplus$ ) or colored green (or green and yellow).

## Audio Input

The MSL-4 presents a 10 k $\Omega$  balanced input impedance to a three-pin XLR connector wired with the following convention:

**Pin 1** — 220 k $\Omega$  to chassis and earth ground (ESD clamped)

**Pin 2** — Signal  
**Pin 3** — Signal

Differential Inputs

**Case** — Earth (AC) ground and chassis

 Shorting an input connector pin to the case can form a ground loop and cause hum.

Pins 2 and 3 carry the input as a differential signal; their polarity can be reversed with the **input polarity** switch on the user panel. If the switch is in the up position, pin 2 is hot relative to pin 3, resulting in a positive pressure wave when a positive signal is applied to pin 2. Use standard audio cables with XLR connectors for balanced signal sources.

**TROUBLESHOOTING NOTE:** If abnormal noise (hum, hiss, popping) is produced from the loudspeaker, disconnect the audio source from the speaker. If the noise stops, then the problem is not within the loudspeaker; check the audio input and AC power.

A single source can drive multiple MSL-4s with a paralleled input loop, creating an unbuffered hardwired loop connection. The input impedance for a single MSL-4 is 10k $\Omega$ ; cascading *n* MSL-4s will produce a balanced input impedance of 10k $\Omega$  divided by *n*. To avoid distortion from the source, make sure that the source equipment can drive the total load impedance

presented by the paralleled input circuit. For most source equipment it is safe to drive circuits whose input impedance is no smaller than 10 times its output impedance. For example, cascading 10 MSL-4s produces an input impedance of 1000 Ohms (10k $\Omega$  divided by 10). The source equipment should have an output impedance of 100 ohms or less.

This is also true when connecting in parallel (loop out) MSL-4s to 650-Ps, DS-4Ps, or any other Meyer Sound self-powered loudspeaker system.

The LD-1A is highly recommended when driving systems using multiple speakers. (See Measurement and Integration Tools, page 9.)

## Amplification and Protection Circuitry

Each driver in the MSL-4 is powered by one channel of the Meyer Sound MP-2, a 1240W RMS amplifier (620W RMS/ch) utilizing complementary power MOSFET output stages (class AB/H). The following sections discuss the MP-2's limiting circuitry and the two-fan cooling system.

### TruPower™ Limiting System

Conventional limiters assume that the resistance of a loudspeaker remains constant and set the limiting threshold by measuring voltage only. This method is inaccurate because the loudspeaker's resistance changes in response to the frequency content of the source material and thermal variations in the loudspeaker's voice coil and magnet. Conventional limiters begin limiting prematurely, which under-utilizes system headroom and deprives the loudspeaker of its full dynamic range.

The TruPower limiting (TPL) system accounts for varying loudspeaker impedance by measuring current, in addition to voltage, to compute the power dissipation and voice coil temperature. TPL improves performance during limiting by allowing the loudspeaker to produce its maximum SPL across its entire frequency range and extends the lifetime of the drivers by controlling the temperature of the voice coil.

**HI Limit** and **LO Limit** LEDs on the user panel indicate TPL activity for the high and low frequency amplifier channels. When either channel exceeds the safe continuous power level, its limiter engages, ceasing operation when the power level returns to normal. The limiters for each channel function independently and do not affect the signal when the LEDs are inactive.

The MSL-4 performs within its acoustical specifications and operates at a normal temperature if the limit LEDs are on for no

longer than two seconds, and off for at least one second. If either LED remains on for longer than three seconds, that channel is **hard limiting** with these negative consequences:

- Increasing the input level will not increase the volume.
- The system distorts due to clipping and nonlinear driver operation.
- Unequal limiting between the low and high frequency drivers alters the frequency response.
- Driver and amplifier life-span is reduced because they are subjected to excessive heat.

NOTE: Although the TPL limiters exhibit smooth sonic characteristics, we do not recommend using them for intentional compression effects. Use an outboard compressor/limiter to compress a mixed signal.

The TPL LEDs can indicate an imbalance in a configuration of loudspeakers by functioning like a spectrum analyzer. If the loudspeakers in a subwoofer, mid-bass, or mid-hi subsystem begin to limit before reaching the required operating level for the entire system, then that subsystem needs to be supplemented with additional loudspeakers.

## Fans and Cooling System

The MSL-4 uses a forced-air cooling system with two fans to prevent the amplifiers from overheating. The fans draw air in through ducts on the front of the cabinet, over the heatsinks, and out the rear of the cabinet. Since dust does not accumulate in the amplifier circuitry, its life-span is increased significantly.

A foam insert filter, in combination with the entire front grill surface, acts as an air filter for the cooling system. Despite the filtering, extensive use or a dusty operating environment can allow dust to accumulate along the path of the airflow, preventing normal cooling. We recommend periodically removing the grill, filter, and amplifier module and using compressed air to clear dust from the grill, filter, fans, and heatsinks. Make sure that the air ducts are clear and that there is at least six inches clearance for exhaust behind the cabinet.

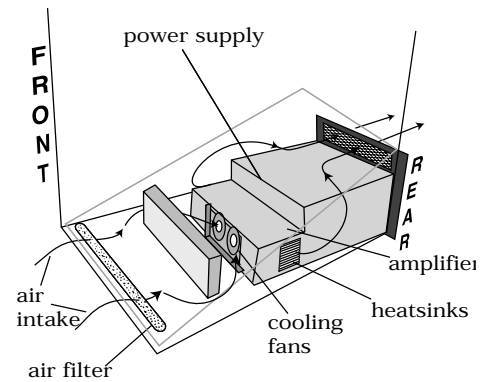

A variable-speed primary fan runs continuously with an inaudible operating noise of 22dBA at 1 m at its slowest speed. The speed of the primary fan begins increasing when the temperature of the heatsinks reaches 42°C. The fan reaches full speed at 62°C and is barely audible near the cabinet, even without an audio signal.

In the unusual event that the heatsink temperature reaches 74°C, the secondary fan turns on; it turns off when the temperature decreases to 68°C. The secondary fan is audible at close proximity without an audio signal and turns on in response to

- primary fan failure (check its status immediately);
- a prolonged period of high source levels in hot temperatures or direct sunlight;
- accumulation of dust in the cooling system path;
- driver failure.

TROUBLESHOOTING NOTE: In the highly unlikely event that the secondary fan does not keep the temperature below 85°C, the MSL-4 automatically shuts down until AC power is removed and reapplied. If the MSL-4 shuts down again after cooling and reapplying AC power, contact Meyer Sound for repair information.

# Rigging

Two types of rigging hardware are available to fly the MSL-4 loudspeaker system: Aircraft pan fittings and the optional L-Track system. Both are installed and tested exclusively at Meyer Sound Laboratories.

## Aircraft Pan Fittings Only

The MSL-4 without L-Track weighs 184 lb (83.5 kg). The maximum recommended load for an MSL-4 with aircraft pan fittings is 600 lb (273 kg). This *working load* is based on a 5:1 safety factor. The MSL-4 has six rigging brackets (three on top and bottom of the cabinet); each bracket is capable of supporting the full working load of the cabinet.

rigging brackets  
three on top, three on bottom

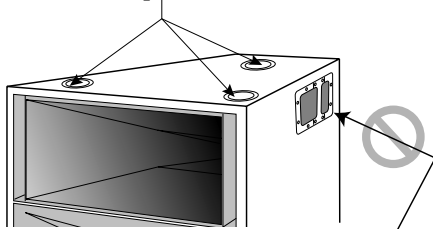

⚠ Handles are for carrying only.  
Do not use them for rigging!

## The MSL-4 with Optional L-Track Rigging System

There are four types of interchangeable rigging brackets, each fastened by six Phillips screws:

- aircraft pan fittings (ring and stud)
- $\frac{3}{8}$ "-16 nut plates
- M-10 x 1.5 metric nut plates
- blank plates (if no rigging brackets are requested)

NOTE: Units with nut plates are rated for the weight of one cabinet only.

Rigging load ratings assume a straight tensile pull and that the cabinet is in new condition with aircraft pan fittings. If these conditions are not met, the load ratings can be reduced significantly. Load ratings can also be reduced by age, wear, and damage. It is important to inspect the rigging hardware regularly and replace worn or damaged components immediately.

The cabinet, exposed electronic circuitry, and drivers can receive protective treatment that permits safe use in wet conditions. Additionally, a rain hood can be fitted to shield cables and electronics. *Do not install a unit outdoors without weather protection!* Contact Meyer Sound for more information.



The MSL-4 equipped with the L-Track rigging system weighs 205 lbs (93 kg). The **maximum recommended load for an L-Track-equipped MSL-4 at vertical pull using any 2 points is 1500 lbs. (682 kg)**. We strongly recommend using all four rigging points per end. This *working load* is based on a 5:1 safety factor<sup>1</sup>.

L-Track provides eight rigging points (four on the top and bottom end of each cabinet); the maximum working load of each individual point is dependent on the direction in which the cabinet is being pulled at each particular point. Figure 1 on the following page shows the working loads for each point as they vary depending on cabinet pull angle.



**NOTE:** When flying the MSL-4 using the L-Track system, it is absolutely imperative that you do not exceed either the maximum recommended working load for an entire cabinet or the working load of any individual rigging point.

All working load limit ratings assume the cabinet, fittings, and L-Track are in new condition. If not, the load ratings can be reduced significantly. It is important to inspect the rigging hardware regularly and replace worn or damaged components immediately.

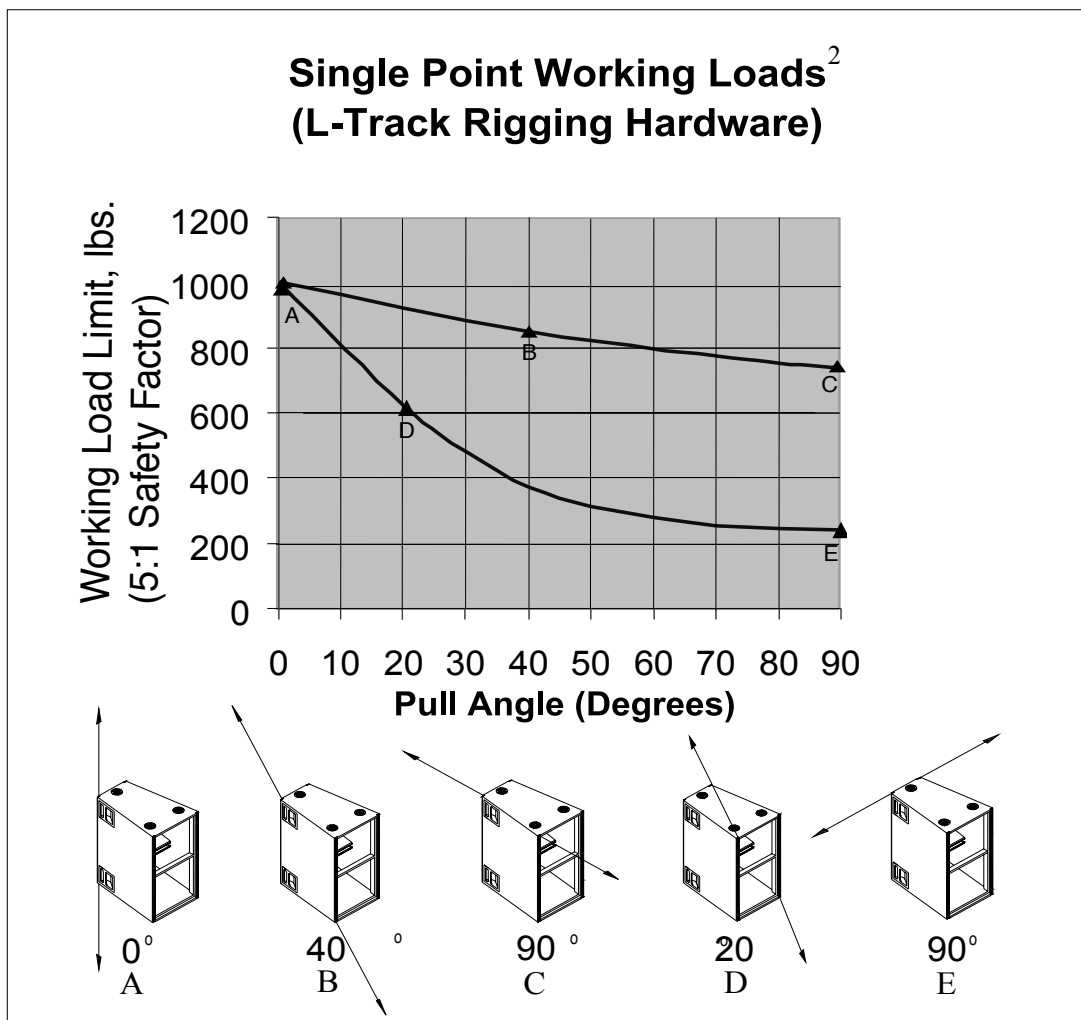

<sup>1</sup>Depending upon your geographic location a different safety factor may be required. All Meyer Sound products must be used in accordance with local, state, federal, and industry regulations. It is the owner's and/or user's responsibility to adhere to local regulations and evaluate the reliability of any rigging method for their application. Rigging should be done only by experienced professionals.

<sup>2</sup>Results from tests of the L-Track rigging system using the New Haven Part # NH47556-12.

# Measurement and System Integration Tools

It is essential that even the most carefully assembled sound systems be analyzed with precise measurement tools. We recommend using the Meyer **SIM® System II Sound Analyzer** and **CP-10 Parametric Equalizer** to

- assist the process of configuring speaker systems;
- measure propagation delays between subsystems to set the correct polarity and delay times;
- measure and equalize variations in frequency response caused by the acoustical environment and the placement and interaction of speakers.

We recommend using the Meyer Sound **LD-1A Line Driver** to integrate different types of Meyer self-powered loudspeakers into a complete system. The LD-1A has two channels equipped to control a full-range main system, and six auxiliary channels for down-fill, front-fill, and delay systems. The LD-1A maintains signal integrity for long cable paths and provides the following useful functions:

- The **Lo Cut** switch activates a high-pass filter (160Hz, -12 dB/oct, Q = 0.8) that performs a crossover function for the Mid-Hi output.
- The **DS-2/DS-4 & Sub Crossover** switch (channels 1 and 2 only) activates a crossover network optimized for the DS-2P and DS-4P when used with the 650-P. With the switch **in**, frequencies below 80Hz are sent to the Sub output (for the 650-P), and above 80Hz to the DS-2 output. When the 650-P is used without the DS-4P, the switch should be **out**, which sends a full-range signal to both the DS-2 and Sub outputs.
- The **DS-2/DS-4** and **Sub** switches (channels 1 and 2 only) toggle the polarity for the DS-2 and Sub outputs.
- The **Mid-Hi**, **DS-2**, and **Sub** outputs (channels 1 and 2 only) each have their own gain control and mute switch.

**POLARITY NOTE:** The polarity for Meyer self-powered loudspeaker systems may be reversed using the input polarity switch on the user panel. The LD-1A also allows polarity reversal with the DS-2 f and Sub f switches for loudspeakers connected to the DS-2 and Sub outputs. When making polarity decisions in applications that include the LD-1A, check the state of all polarity switches.

Contact Meyer Sound for assistance with your application.

# Complete Systems

Meyer Sound loudspeaker systems are designed to complement one another, with the goal of ensuring full harmonic depth and richness to the auidial experience.

The following Meyer Sound loudspeaker systems are mentioned in the example applications. Note that each application requires the use of the LD-1A line driver.

- CQ:** Self-powered loudspeaker
- DS-2P, DS-4P:** Self-powered mid-bass loudspeakers
- 650-P:** Self-powered subwoofer
- PSW-2, PSW-4:** Self-powered subwoofers
- 650-R2:** Externally amplified subwoofer

The Meyer Sound self-powered loudspeaker systems listed above have a **loop** connection to send the input signal to another loudspeaker. Full-range signals can be applied to all Meyer Sound self-powered subwoofers because they have built-in active crossovers that filter mid-hi frequencies.

The cabinets in the following examples are in a close-proximity coplanar orientation, unless otherwise stated. Externally amplified Meyer subwoofers require the opposite polarity to all Meyer self-powered speakers. Separating speakers by more than 5 ft may require polarity reversal to compensate for the propagation delay between the loudspeakers and the measurement or listening position.

## MSL-4 and 650-P

The MSL-4 is particularly well matched with the 650-P and PSW-2 and also performs efficiently with the PSW-4. Due to the overlap in frequency response between the MSL-4 and the subwoofer, the system frequency response exhibits a low frequency (LF) rise in the range 65–120Hz. It is important to emphasize that the loudspeakers are in phase in this region. The rise can be corrected using the Meyer Sound CP-10 Parametric Equalizer, if desired.

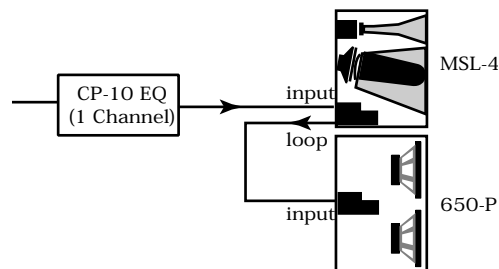

Set the MSL-4 and 650-P to the same polarity.

## LD-1A with MSL-4 and 650-P

A typical MSL-4:650-P ratio is 2:1 but separate Sub and Mid-Hi level controls on the LD-1A allow the ratio to vary while maintaining control of the spectral balance of the system. The Lo Cut filter for CH1 Mid-Hi should be **in** to correct the LF rise between the MSL-4 and 650-P.

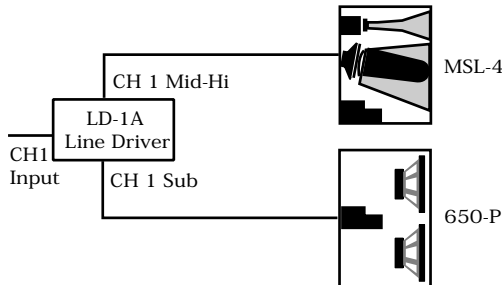

Set the MSL-4 and 650-P to the same polarity.

## LD-1A with Flown PSW-2 and MSL-4; 650-P on the Floor

Including subwoofers in a flown cluster provides a smooth frequency image because the low and mid-hi frequencies are produced from loudspeakers located close together. The identical dimensions of the PSW-2 and MSL-4 allow them to be easily flown together.

The CH 1 Mid-Hi output drives the MSL-4 with the Lo Cut filter **in**. The CH 1 Sub and DS-2 outputs drive the 650-Ps and PSW-2s with the DS-2 & Sub Crossover switch **out**, which sends a full-range signal with independent level control to each loudspeaker.

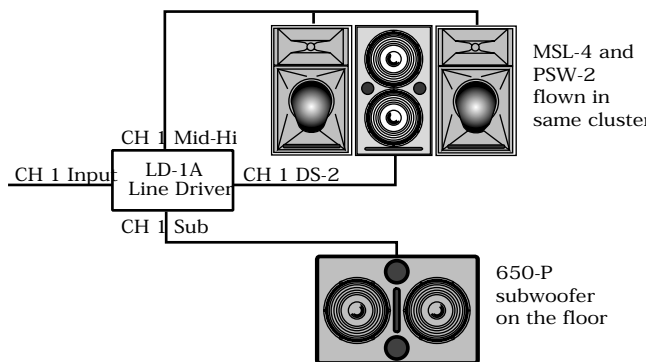

Set the MSL-4 and PSW-2 to the same polarity. The polarity for the 650-P depends on the height and distance of the measurement position from the flown and subwoofer systems.

## LD-1A with Flown MSL-4, DS-2P/DS-4P, and CQ; 650-P on the Floor

This example shows the LD-1A integrating a complete system of self-powered loudspeakers for a large venue. Although the diagram shows half of the system with channels 1, 3, and 5, channels 2, 4, and 6 can be used with identical connections for the other half. The MSL-4, DS-2P/DS-4P, and CQ arrays are flown; the 650-Ps are on the floor.

The CH 1 Mid-Hi and CH 3 outputs drive the inner three and outer two loudspeakers of the MSL-4 array, applying appropriate levels for loudspeakers directed at different distances. The diagram shows the additional mid-hi output created by connecting the CH 1 Loop to the CH 3 input. Using a Y-connection at the CH 1 input (as shown for the down-fills) accomplishes the same signal routing. The Lo Cut and Array EQ switches for both channels should be **in**. The Lo Cut filters eliminate the LF rise caused by the frequency response overlap between the MSL-4 and DS-2P/DS-4P/650-P systems. The Array EQ filters minimize the MSL-4 array's low-mid rise.

The CH 1 DS-2 and Sub outputs drive the DS-2P/DS-4P and 650-P loudspeaker systems with the DS-2 & Sub Crossover switch **in**. Set the MSL-4 and DS-2P/DS-4P to the same polarity. The polarity of the 650-P depends on the height and distance of the measurement position from the subwoofer and flown systems.

CH 5 controls the CQ down-fill system. Since the main system is more powerful than the down-fill system to project farther into the venue, the main system is audible in the down-fill's coverage area. To insure that the loudspeakers combine properly in the intersecting coverage area:

- Set the CQ to the opposite polarity to the MSL-4 to phase align the mid-hi frequencies and minimize the MSL-4's LF down-lobe.
- Use the CH 5 Lo Cut filter to eliminate the LF rise caused by the overlap in frequency response with the 650-P and DS-2P/DS-4P systems.
- Delay the down-fill to compensate for the propagation delay between the down-fill and main systems in the intersecting coverage area.

We recommend that the entire system be measured, phase-aligned, and equalized using the SIM System II Sound Analyzer and CP-10 Parametric Equalizer.

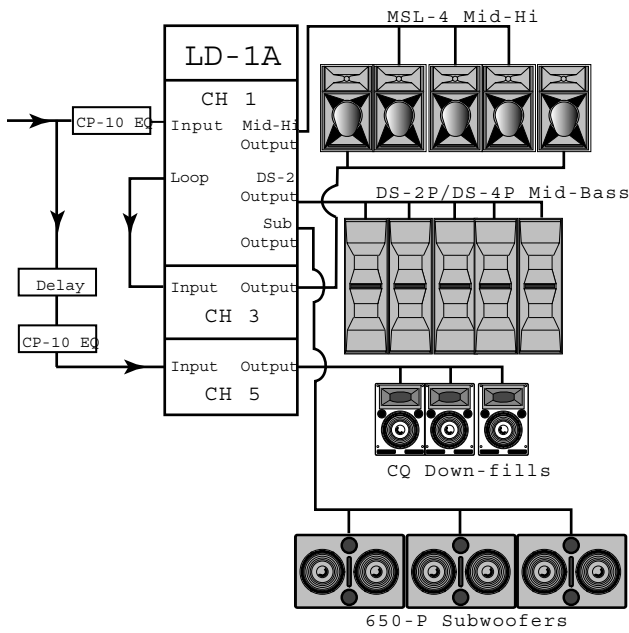

Set the MSL-4 and DS-4P to the same polarity; reverse the polarity for the CQ. The polarity for the 650-P depends on the height and distance of the measurement position from the flown and subwoofer systems.

### MSL-4 and 650-R2

Although it is preferable to use the MSL-4 in a completely self-powered system, excellent results can still be achieved using the 650-R2, USW-1, and MSW-2.

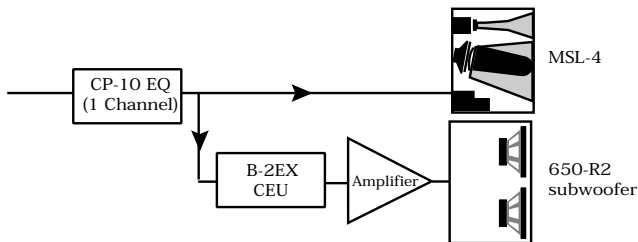

Set the MSL-4 to the opposite polarity to the 650-R2 amplifier.

## Driver Troubleshooting

### Troubleshooting with TPL

The TPL LED can indicate serious driver problems, if interpreted correctly. If one MSL-4 in a system exhibits substantially more TPL activity than others receiving the same audio signal, then one or both drivers in that unit may have a short circuit. This is a potentially dangerous condition for the electronics; shut the MSL-4 down immediately.

The TPL circuit does not activate if there is no power dissipation in the driver, regardless of the input signal level. Therefore, if all MSL-4s in a system receiving the same audio signal exhibit TPL activity except one, then that unit may have an open voice coil; disconnect it and contact Meyer Sound for repair information.

NOTE: The Remote Monitoring System (RMS) provides precise information about peak power, peak voltage, and average voltage (VU) for each amplifier channel, enabling a more complete driver diagnostic than the TPL LEDs. Contact Meyer Sound for more information about RMS.

### Driver Replacement

To determine whether a low or high frequency driver is functioning properly, or replace a damaged driver, contact Meyer Sound to obtain the Low Driver Inspection and Evaluation Procedure for Self-Powered Series Products (part # 17.010.120.01) or the High Driver Inspection and Evaluation Procedure for Self-Powered Series Products (part # 17.010.120.02).

### Verifying Driver Polarity

Incorrect driver polarity impairs system performance and may damage the drivers. All Meyer loudspeakers are shipped with the drivers in correct alignment. However, if the driver or circuit wiring has been removed or disassembled in any loudspeaker in a system for any reason, it is essential to check the polarity between drivers in the same cabinet and between adjacent loudspeakers.

We do not recommend using phase poppers to analyze driver polarity. The phase response for all drivers varies, to some degree, over the frequency range in which it operates. Since the phase popper, a popular but inaccurate tool, does not discern variations in phase response with respect to frequency, it provides no useful information about the phase response through the crossover, the most important consideration for determining correct driver polarity.

Phase poppers are, therefore, not useful for performing phase measurements on an individual loudspeaker or a full-range sound system containing one or more crossovers. If necessary, apply a phase popper only to loudspeakers with identical drivers without a crossover, and check the system's overall phase response with a frequency analyzer and/or listening test.



Since polarity reversal causes excessive driver excursion at high source levels, use moderate levels when conducting these tests.

## Driver Polarity in the Same Loudspeaker

Use the following test procedure to verify polarity between drivers in the same loudspeaker:

1. Place a measurement microphone 3 ft from the front of the loudspeaker at the midway point between the low and high frequency drivers.
2. Connect a signal source to the loudspeaker and note the frequency response.

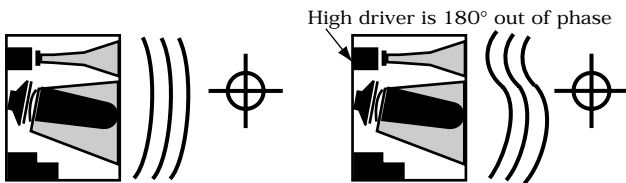

Drivers with correct polarity cause acoustic addition

Drivers with reversed polarity cause acoustic cancellation

The polarity is correct if the frequency response is smooth through the crossover region (600Hz – 1 Hz). Cancellation greater than 6 dB in the same range indicates polarity reversal.

## Driver Polarity In Adjacent Loudspeakers

Use the following test procedure to verify the polarity between two adjacent loudspeakers *of the same type*:

1. Position two loudspeakers adjacent to each other.
2. Place a measurement microphone 3 ft from the speakers on the axis between them.
3. Connect a signal source to one speaker and note the frequency response and overall level.
4. Apply the same signal to the second speaker with the first speaker still connected.

The polarity is correct if the frequency response remains constant with a significant increase in amplitude. Broadband cancellation (decreased overall level) indicates polarity reversal.

# Array Design

Creating an effective array with the MSL-4 requires a precise understanding of how to combine the coverage area and SPL of the individual speaker with those of adjacent speakers. Array design is a trade-off between increasing on-axis power and creating smooth transitions between the coverage areas of adjacent speakers.

As the splay angle (the angle between adjacent cabinet faces) decreases below the coverage angle of the individual speaker, the on-axis power increases, but the coverage overlap between adjacent speakers causes comb filtering and other frequency response variations.

As the splay angle increases toward the coverage angle, the on-axis power decreases, but the variations in frequency response diminish. As the splay angle increases beyond the coverage angle, noticeable gaps begin to form in the array's coverage area.

NOTE: The trapezoidal shape of the MSL-4 determines only the narrowest recommended splay angle (15°) for horizontal arrays and does not represent the horizontal coverage area.

A series of outdoor tests was conducted at Meyer Sound Laboratories to determine coverage angles and on-axis SPL

for arrays with one and two horizontal rows of up to six speakers each, at numerous splay angles. The measurements were conducted at a distance of 8 m with half-space loading; on-axis SPL values were interpolated from 8 m to 1 m. The coverage angle for the array is the result of averaging the -6 dB points from 125Hz to 8kHz.

The horizontal angles in the tables on the next page represent the optimal narrow (15°), middle (22.5°), and wide (30°) orientations for the MSL-4. The 10° and 20° vertical splay angles represent the optimal narrow and wide vertical configurations. **2@0° LT** denotes *long throw*: the two horns are coupled directly together (top speaker upside down/bottom speaker upright) to form a single narrow horn.

The following tables show the SPL and coverage areas that result from grouping the MSL-4 in arrays of up to six units horizontally and two rows vertically. If this information does not address your application requirements, contact Meyer Sound to obtain additional information on array design.

MSL-4 Array Coverage and Maximum SPL Chart

Horizontal Units & Angle	1			2 @ 15°			2 @ 22.5°			2 @ 30°			3 @ 15°			3 @ 22.5°			3 @ 30°			4 @ 15°		
	Coverage		Max SPL (dB Fk)	Coverage		Max SPL (dB Fk)	Coverage		Max SPL (dB Fk)	Coverage		Max SPL (dB Fk)	Coverage		Max SPL (dB Fk)	Coverage		Max SPL (dB Fk)	Coverage		Max SPL (dB Fk)	Coverage		Max SPL (dB Fk)
	H	V		H	V		H	V		H	V		H	V		H	V		H	V		H	V	
Vertical Rows & Angle																								
1	40°	35°	140	20°	35°	145	50°	35°	143	70°	35°	141	55°	35°	147	80°	35°	146	100°	35°	146	70°	35°	149
2 LT (0°)	40°	20°	146	20°	20°	151	50°	20°	149	70°	20°	147	55°	20°	153	80°	20°	152	100°	20°	152	70°	20°	155
2 @ 10°	40°	40°	145	20°	40°	150	50°	40°	148	70°	40°	146	55°	40°	152	80°	40°	151	100°	40°	151	70°	40°	154
2 @ 20°	40°	55°	144	20°	55°	149	50°	55°	147	70°	55°	145	55°	55°	151	80°	55°	150	100°	55°	150	70°	55°	153

Horizontal Units & Angle	4 @ 22.5°			4 @ 30°			5 @ 15°			5 @ 22.5°			5 @ 30°			6 @ 15°			6 @ 22.5°			6 @ 30°		
	Coverage		Max SPL (dB Fk)	Coverage		Max SPL (dB Fk)	Coverage		Max SPL (dB Fk)	Coverage		Max SPL (dB Fk)	Coverage		Max SPL (dB Fk)	Coverage		Max SPL (dB Fk)	Coverage		Max SPL (dB Fk)	Coverage		Max SPL (dB Fk)
	H	V		H	V		H	V		H	V		H	V		H	V		H	V		H	V	
Vertical Rows & Angle																								
1	100°	35°	148	130°	35°	147	95°	35°	150	120°	35°	147	160°	35°	146	100°	35°	150	145°	35°	148	185°	35°	147
2 LT (0°)	100°	20°	154	130°	20°	153	95°	20°	156	120°	20°	153	160°	20°	152	100°	20°	156	145°	20°	154	185°	20°	153
2 @ 10°	100°	40°	153	130°	40°	152	95°	40°	155	120°	40°	152	160°	40°	151	100°	40°	155	145°	40°	153	185°	40°	152
2 @ 20°	100°	55°	152	130°	55°	151	95°	55°	154	120°	55°	151	160°	55°	150	100°	55°	154	145°	55°	152	185°	55°	151

# Specifications

<b>Acoustical</b>	
Frequency Response <sup>1</sup>	±4dB 65Hz-18kHz:-6dB at 60Hz and 20kHz
Phase Response <sup>1</sup>	±30° 450Hz-10kHz
Maximum Peak SPL <sup>1</sup>	140dB
Dynamic Range <sup>2</sup>	> 110dB
Coverage	40° H x 35° V
<b>Transducers</b>	
Low Frequency	12" diameter MS-12 cone (3" voice coil)
High Frequency	2" throat, 4" diaphragm MS-2001A compression driver
Acoustic Crossover Point	800Hz
<b>Audio Input</b>	
Type	Complementary power MOSFET output stages class AB/H
Burst Capability <sup>3</sup>	1240 Watts (620 Watts/channel)
THD, IM, TIM	< .02 %
<b>AC Power</b>	
Type	10 kΩ impedance, electronically balanced
Connector	XLR (A-3) male and female
Nominal Input Level	+4 dBu (1.23 Vrms)
<b>Amplifiers</b>	
Connector	250V NEMA L6-20P / IEC 309 Twistlock male receptacle
Automatic voltage selection <sup>4</sup>	85 – 134 V / 165 – 264 V; 50 Hz / 60 Hz
Max Continuous RMS Current (> 10 s)	115 V: 8 A    230 V: 4 A    100 V: 10 A
Max Burst RMS Current (< 1 s)	115 V: 15 A    230 V: 8 A    100 V: 18 A
Max Peak Current During Burst	115 V: 22 Apk    230 V: 11 Apk    100 V: 25 Apk
Soft Current Turn-on	Inrush current < 12 A @115 V
<b>Physical</b>	
Dimensions	21.25" W x 36" H x 30" D
Weight	w/o L-Track: 184 lb (83.5 kg); shipping: 213 lb (96.6 kg) with L-Track: 205 lb (93.2 kg); shipping 226 lb(106.3 kg)
Enclosure/Finish	Multi-ply hardwood/black textured
Protective Grill	Hex perforated steel grill, foam covering
Rigging	Six aircraft pan fittings (three on top and bottom). Working load for each fitting is 600 lb (273kg.) based on a 5:1 safety factor with a straight tensile pull. Optional L-Track rigging system: Working load for each end of the cabinet is 1500 lbs (681.8 kg), based on a 5:1 safety factor. Working load for individual points varies; see the chart on page 9.

## Notes

1. Subject to half-space loading; measured with one-third octave frequency resolution in fixed ISO bands.
2. Measured as the ratio between the peak SPL and the A-weighted noise floor.
3. Nominal 8 Ω resistive load, pink noise, 100V peak.
4. The unit is rated at 88 – 125VAC and 182 – 235 VAC, 50/60 Hz, to satisfy EC standards for –10% to 6% AC line voltage.

## Rear Panel and Optional Module

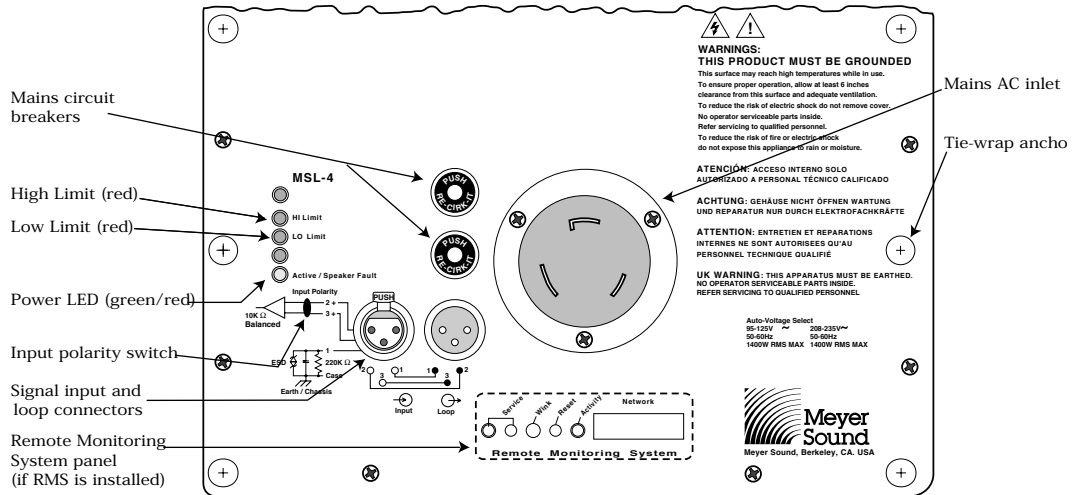

Rear User Panel shown with the optional Remote Monitoring System (RMS) panel

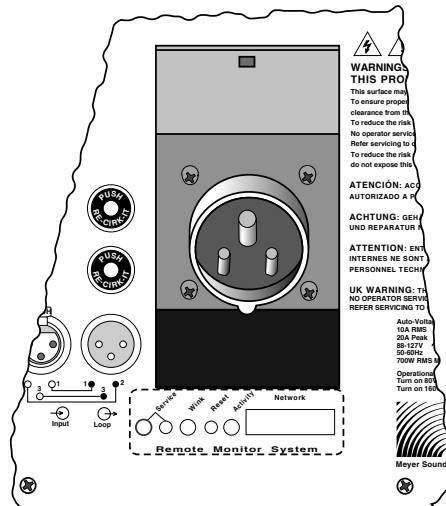

European Rear User Panel with IEC 309 connector



---

## Dimensions

(in inches)

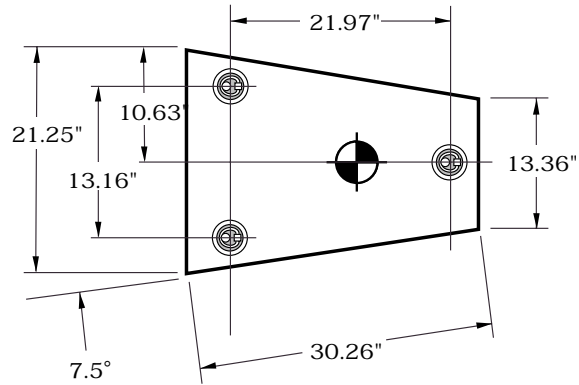

Top

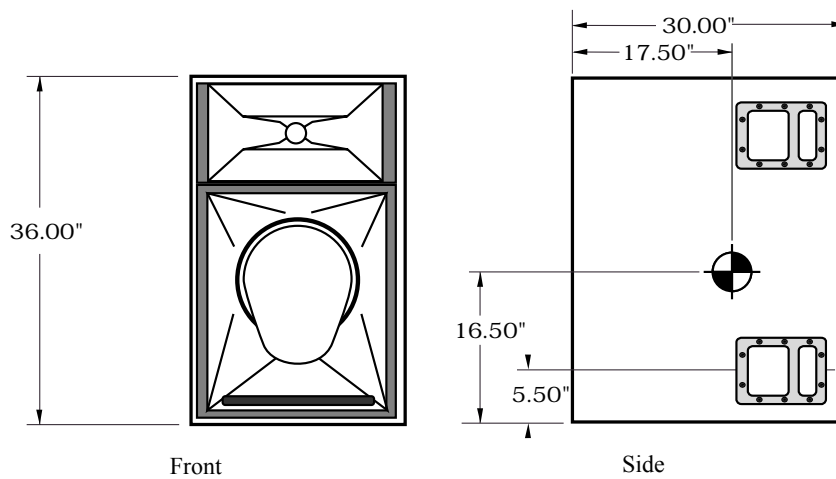

Front

Side

---

## Contact Information

Meyer Sound Laboratories, Inc.  
2832 San Pablo Avenue  
Berkeley, California 94702  
Telephone: 510 - 486 - 1166  
FAX: 510 - 486 - 8356  
E-mail: [techsupport@meyersound.com](mailto:techsupport@meyersound.com)  
<http://www.meyersound.com>

Meyer Sound Europe  
Meyer Sound Germany GmbH  
Carl Zeiss Strasse 13  
D-56751 Polch, Germany  
Telephone: 49.2654.9600.58  
FAX: 49.2654.9600.59  
E-mail: [meyersound@t-online.de](mailto:meyersound@t-online.de)

## Free Manuals Download Website

<http://myh66.com>

<http://usermanuals.us>

<http://www.somanuals.com>

<http://www.4manuals.cc>

<http://www.manual-lib.com>

<http://www.404manual.com>

<http://www.luxmanual.com>

<http://aubethermostatmanual.com>

Golf course search by state

<http://golfingnear.com>

Email search by domain

<http://emailbydomain.com>

Auto manuals search

<http://auto.somanuals.com>

TV manuals search

<http://tv.somanuals.com>