



MICRONIX PC/104 POWER SUPPLY

PV-5127, PV-5127A
POWER SUPPLY MODULE WITH UPS & BATTERY CHARGER

User Manual & Installation Guide

VERS. 1.1

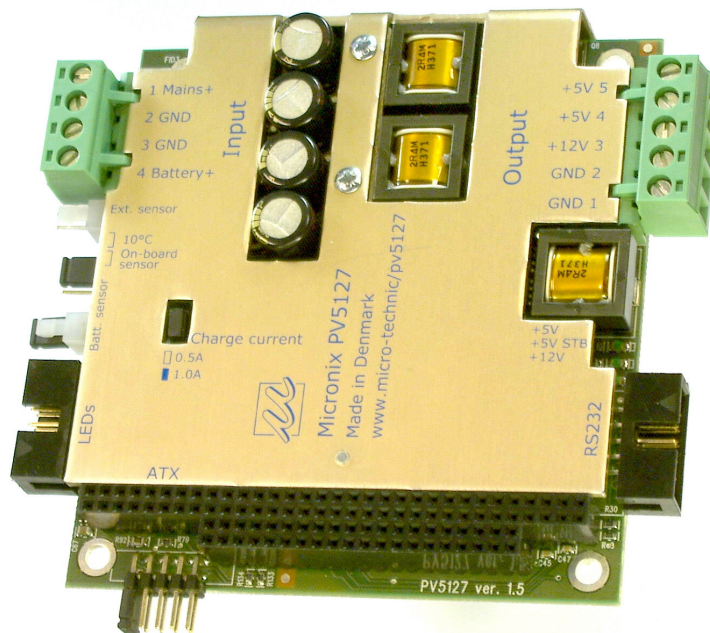

DOC: M5236DM

Micro Technic A-S • Denmark •
Tel. +45 6615 3000 • Fax +45 6615 3077
E-mail: support@micro-technic.com
Website: www.micro-technic.com

Table of contents

TABLE OF CONTENTS	2
REVISION HISTORY	4
GENERAL INFORMATION	5
ORDERING CODES	5
ACCESSORIES.....	5
DESCRIPTION	6
BLOCK DIAGRAM	6
CONNECTORS	8
POWER INPUT CONNECTOR (KL2).....	8
POWER OUTPUT CONNECTOR (KL3)	8
OUTPUT VOLTAGE INDICATORS	8
HEATER AND FAN CONTROL AND EXTERNAL LEADS CONNECTOR (CN2)	9
RS232 CONNECTOR (CN3)	9
ATX CONNECTOR (CN10).....	10
EXT. SENSOR CONNECTOR (J2).....	10
BATT. SENSOR CONNECTOR (J1)	10
PINHEADER (ST3).....	10
PC/104 BUS CONNECTOR (CN1)	11
SYSTEM TEMPERATURE	12
UPS CONTROL	14
PS_ON SIGNAL.....	14
RS232	15
<i>RS232 Status signals</i>	16
<i>RS232 Shutdown signal</i>	16
PC/104 INTERFACE	17
SOFTWARE COMPATIBILITY	19
BATTERY MONITOR AND CHARGER	20
BATTERY VOLTAGES.....	20
LEAD-ACID CHARGER	20
ATX AND SOFTOFF STATE MACHINES	22
THE MAIN DC/DC CONVERTER AND 5V STB	22
THE 5V+12V OUTPUTS.....	22
THE ATX ON/OFF STATE MACHINE	23
THE SOFTOFF STATE MACHINE.....	23
TECHNICAL DATA	25
MECHANICAL LAYOUT	27
INSTALLATION GUIDE	27
INSTALLATION GUIDE	28
PRECAUTIONS TO ESD.....	28
SETTINGS AND CONNECTIONS	28
<i>STI</i>	28

J1..... 28
ST3 28
J2..... 28
CN2 28
CN3 28
CN10 28
KL2..... 29

THERMAL CONSIDERATIONS 30

DIFFERENCES BETWEEN PV-5127 AND PV-5127A 31

BLOCK DIAGRAM OF THE PV-5127A 31

Revision history

Revision number	Reason for change	Date
1.0	Initial revision	23-Mar-04
1.1	Error in mechanical layout changed – page 27.	21-Oct-05

General information

Ordering codes

PV-5127-S
 PV-5127A-S

S=Stack-through PC/104 connector

Available models:

Model no	Description
PV-5127-S	75W PC/104 Power Supply Module (+5V, +12V), 18-35V input supply with UPS/Battery charger
PV-5127A-S	75W PC/104 Power Supply Module (+5V, +12V), 10-35V input supply

Accessories

These accessories must be ordered separately if needed.

Model no	Description
PV-5127-TW40	External temperature sensor for system and battery temperature
CDB-9F	RS232 ribbon cable for "simple signalling" UPS protocol

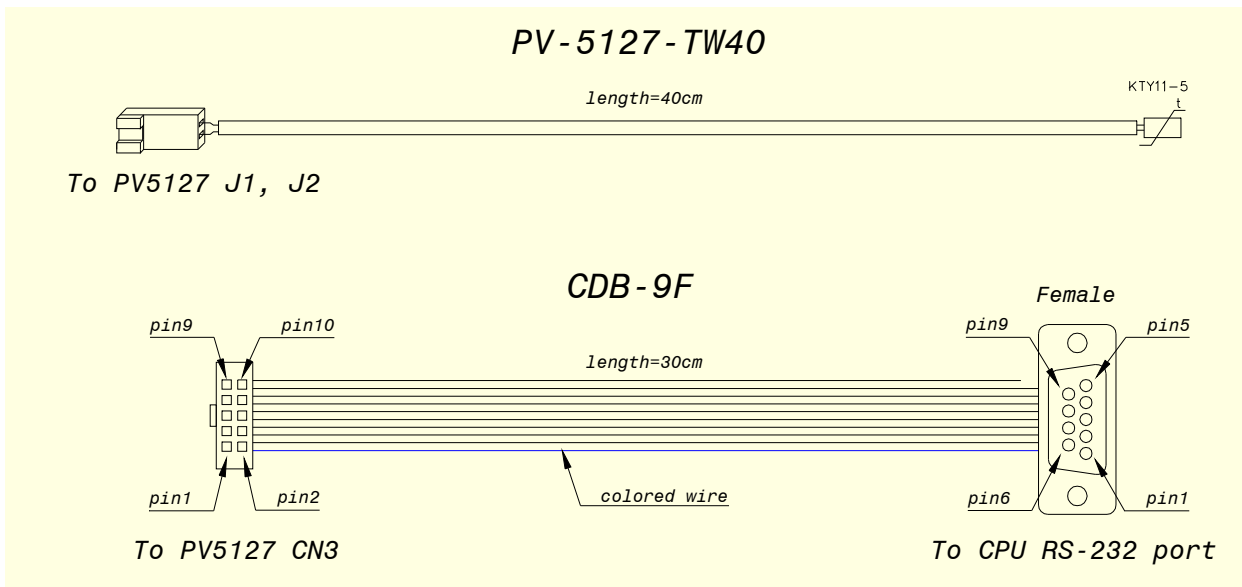

Description

The Micronix PV-5127 is a high efficiency PC/104 power supply for embedded, vehicular and automotive systems applications. It will withstand extended temperatures and the shock and vibration of mobile equipment. Micronix PV-5127 has an input supply range of 18-35V (PV-5127A: 10-35V), which is convenient for automotive and low-voltage applications. Intelligent back-up battery charger with temperature protection of your battery pack. Additionally, it has a built-in fan/heat control. Micronix PV-5127 has support for three ATX signals: PWR_GOOD, PS_ON, and +5V Standby.

Micronix PV-5127 supports sealed lead-acid batteries, and the Micronix PV-1075 PC/104 NiMH battery pack.

Block Diagram

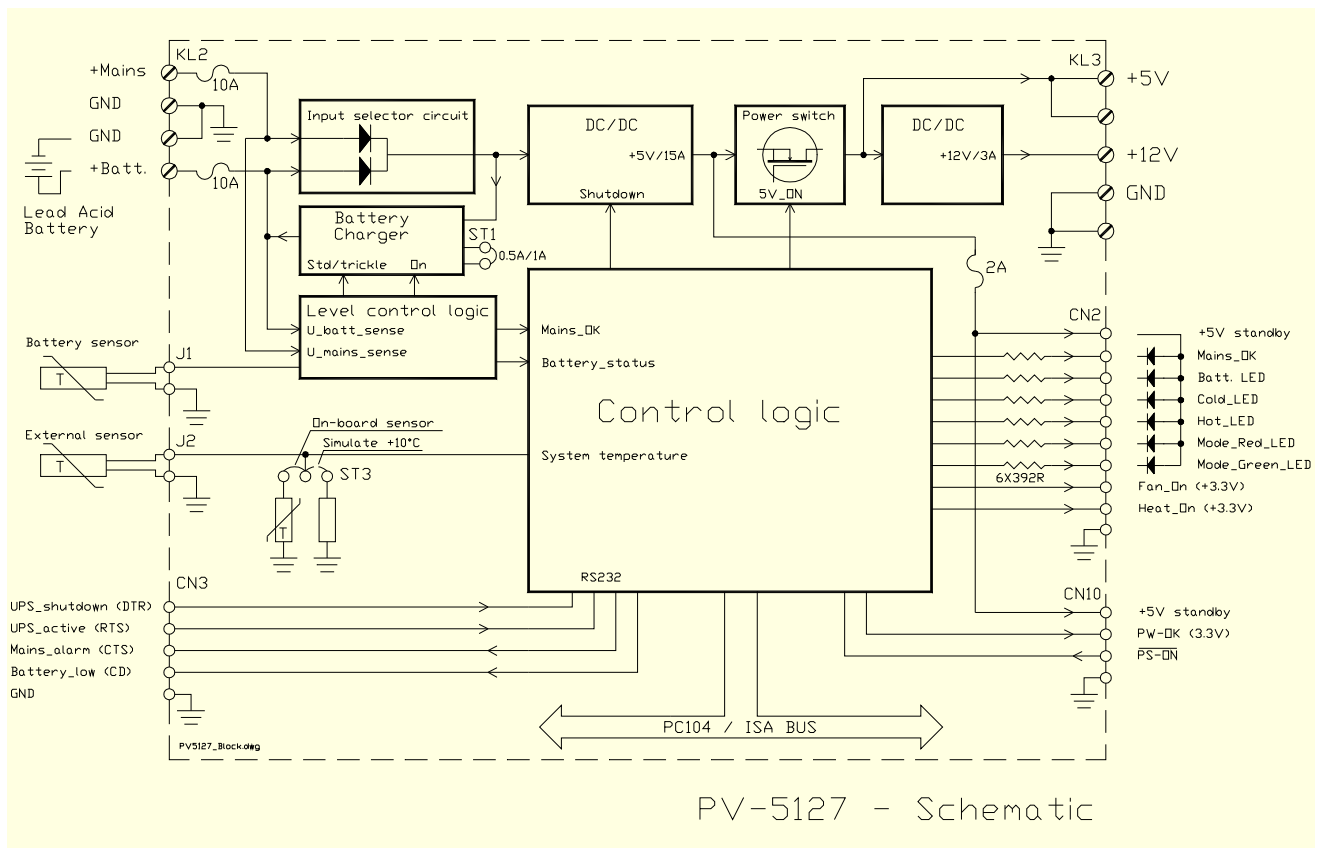

PV-5127 is built around a high efficiency DC/DC converter that converts the incoming DC voltage to 5V/15A. This output is used for +5V Standby and is available at CN2 and CN10. A power switch is used for turning on/off the output voltages +5V and +12V under software control and by the safety shutdown function.

The mains power and backup battery are connected to KL2. The input selector circuit always selects the highest of the two voltages. If the mains voltage drops below the battery voltage, the backup battery immediately takes over.

The mains supply is continuously monitored. There is hysteresis on the mains monitor so that a mains failure is reported when the mains voltage drops below 16.5V, and mains is reported OK when the voltage rises above 17.5V.

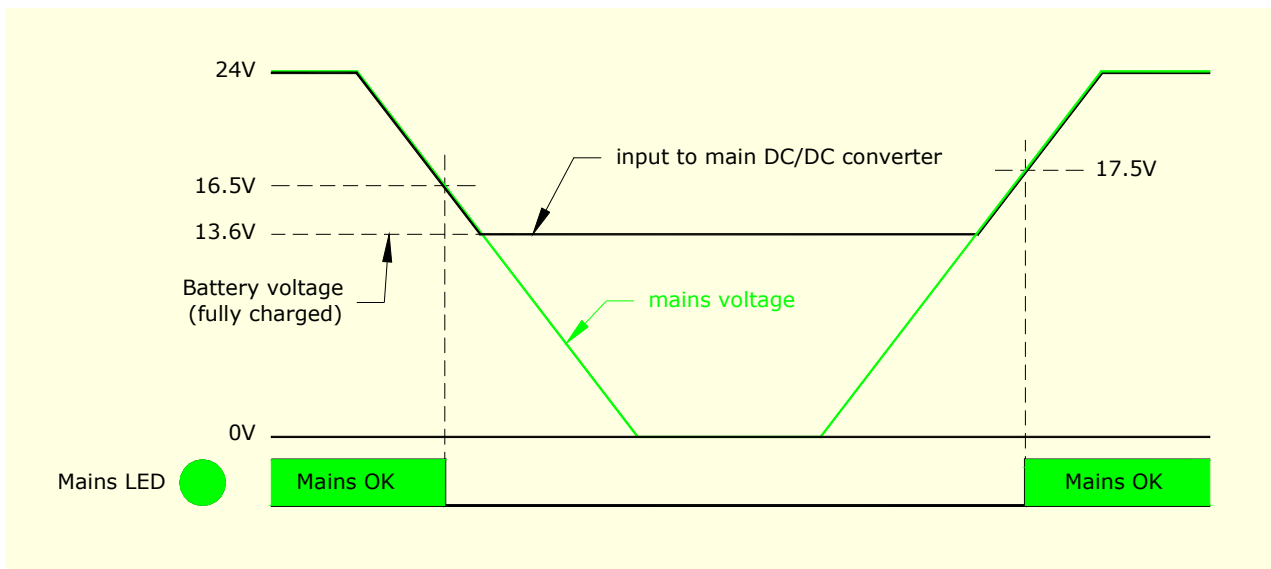

The connected lead-acid backup battery is maintained by an integrated battery charger (fast charge and trickle charge). Using an external battery temperature sensor, you can disable the charging if the battery is too hot. See the section *Battery monitor and charger*.

The PV-5127 can also monitor the system (ambient) temperature and prevent the CPU from starting if it is too cold or too hot, and advise it to shut down if it is too hot. The system temperature can also be used to control an external fan and heating element. See the section *System temperature*.

UPS monitoring software on the CPU can get UPS status information through the RS232 port and the PC/104 bus, and it can perform a software-controlled power-off through the ATX signal PS_ON, the RS232 port, and the PC/104 bus. See the section *UPS control*.

Connectors

The PC-5127 is equipped with nine connectors:

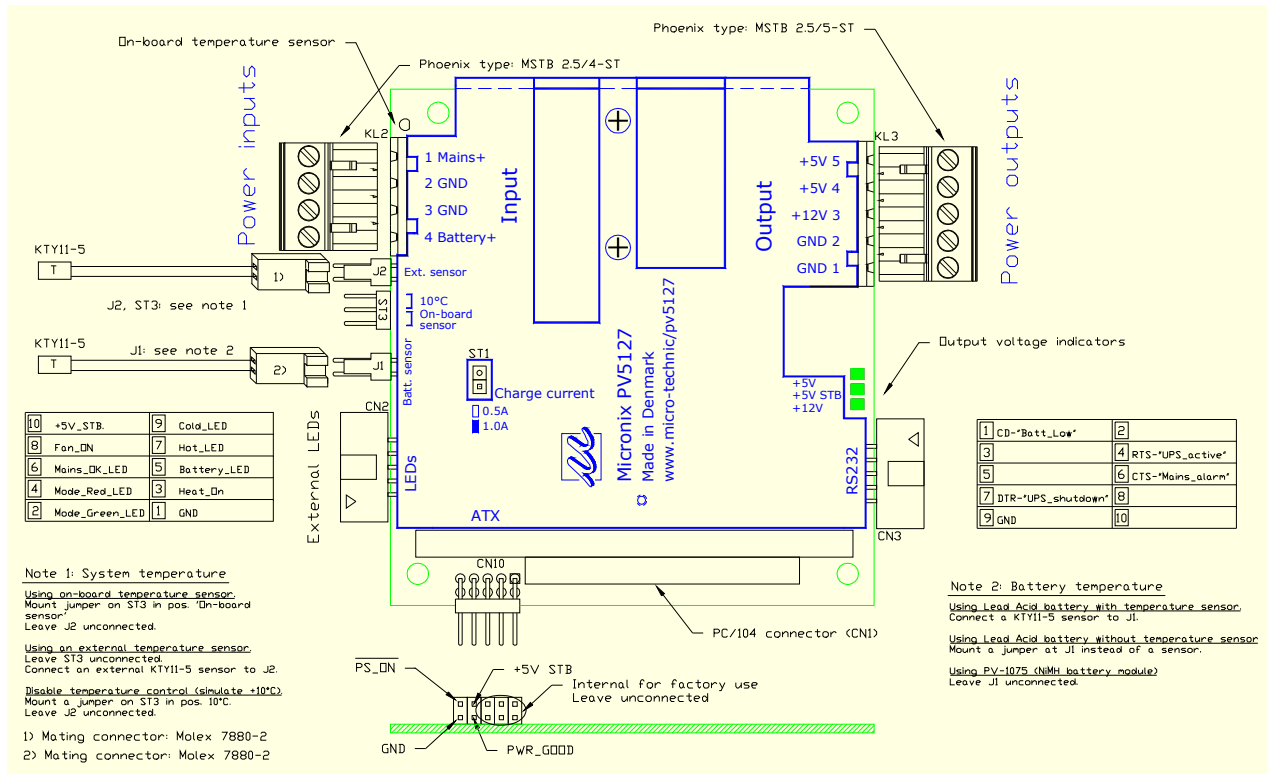

Power input connector (KL2)

Power into PV-5127 (Mains and battery) is supplied through KL2 that is a four-pole removable screw clamp connector. The layout of this connector is printed in the silkscreen on the heatsink.

Power output connector (KL3)

Power out of PV-5127 (+5V and +12V) is applied to KL3 that is a five-pole removable screw clamp connector. The layout of this connector is printed in the silkscreen on the heatsink.

Output voltage indicators

Three green LEDs indicate presence of the output voltages +5V, +5V Standby, and +12V.

Heater and fan control and external LEDs connector (CN2)

Status for PV-5127 can be shown on external LEDs. These must be connected to CN2 by a 10 position ribbon cable with a mating connector. Furthermore, the +5V Standby and logical outputs for the external heating element and the external fan are placed in this connector. The layout of this connector is shown in the schematic to the left of the connector. The function of the individual LEDs is shown in the table:

LED name	Pin no	Function
GND	1	System GND.
Mode_Green_LED	2	See note.
Heat_On	3	Logical output for external heat element, 3.3V when active.
Mode_Red_LED	4	See note.
Battery_LED	5	See section <i>Battery monitor and charger</i> .
Mains_OK_LED	6	On when mains supply OK.
Hot_LED	7	See section <i>UPS control</i> .
Fan_On	8	Logical output for external fan, 3.3V when active.
Cold_LED	9	See section <i>UPS control</i> .
+5V_STB	10	+5V standby, is active when the main DC/DC converter is on.

Note: Mode_Green_LED and Mode_Red_LED are intended for use with a two-color red+green LED. When both Mode LEDs are on, you get yellow. The possible colors are:

Mode LED color	Function
Green	On, both +5V and +12V are on
Yellow	Standby, only +5V Standby is on
Off	Off, main DC/DC converter is off

The LEDs should be connected like this:

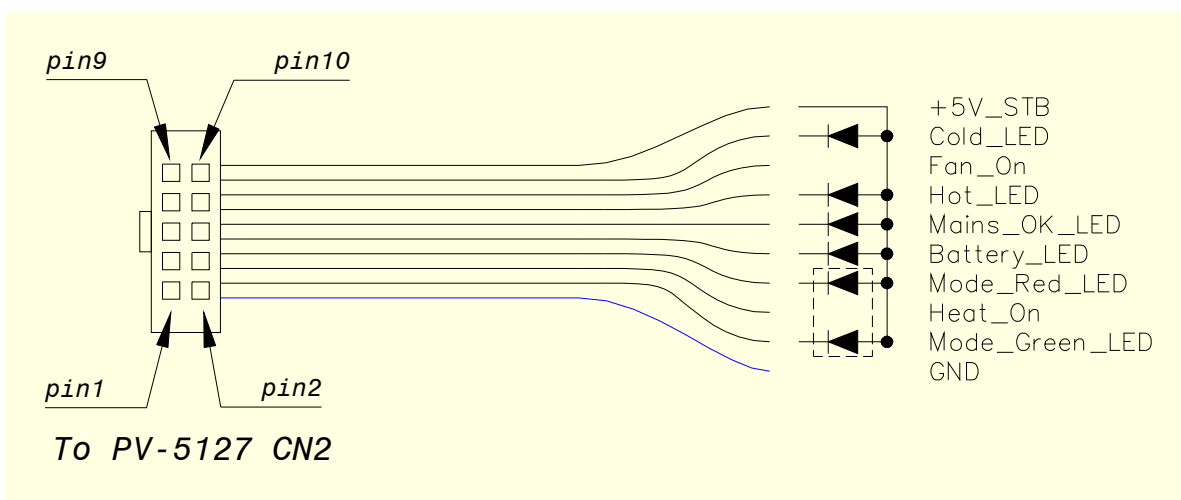

RS232 connector (CN3)

This connector is documented in the *UPS Control* section.

ATX connector (CN10)

The ATX connector holds the three ATX-signals: PS_ON, PWR_GOOD and +5V Standby. The layout of this connector is shown in the schematic. The function of the individual ATX signals is shown in the table:

ATX signal	Pin no	Function
GND	1	System GND
*	2	For factory use only
*	3	For factory use only
*	4	For factory use only
*	5	For factory use only
*	6	For factory use only
+5V STB	7	+5V Standby
PWR_GOOD	8	This pin is 3.3V when +5V and +12V is OK
PS_ON	9	This pin must be pulled low in order to start PV-5127
GND	10	System GND

Ext. sensor connector (J2)

This connector is for an external ambient (system) temperature sensor, see section *System temperature*. The input is designed for the Infineon KTY11-5 temperature dependent resistor (Infineon ordering code Q62705-K245). Mating connector for J2 is Molex 7880-2. A ready-made sensor with a 40 cm cable and connector is available as the PV-5127-TW40 accessory.

Batt. sensor connector (J1)

This connector is for an external battery temperature sensor, or a jumper, see section *Battery monitor and charger*. The input is designed for the Infineon KTY11-5 temperature dependent resistor (Infineon ordering code Q62705-K245). Mating connector for J1 is Molex 7880-2. A ready-made sensor with a 40 cm cable and connector is available as the PV-5127-TW40 accessory. From the factory, a jumper is installed, disabling the battery temperature control.

Pinheader (ST3)

This pinheader is for configuring the System temperature measurement, see section *System temperature*. You can mount a jumper in the “10°C” position, in the “On-board sensor” position, or you can leave it unconnected. The factory default is a jumper in the “10°C” position.

Jumper position (ST3)	Input for System temperature
No jumper installed	Sensor connected to J2
Jumper on ‘On-board sensor’	On-board sensor. Leave J2 unconnected.
Jumper on ‘10°C’	Simulate +10°C. Leave J2 unconnected. (Factory default)

PC/104 bus connector (CN1)

The PC/104 connector is for connecting the PV-5127 to the CPU and other PC/104 boards. There is a female connector on the top, and pins on the bottom so that you can mount other PC/104 boards both above and below the PV-5127.

The main +5V and +12V outputs are available in the PC/104 connector, so you don't need to use the KL3 outputs when drawing smaller currents. The maximum allowed current through the PC/104 connector is 2A per pin. Using all three 5V pins in parallel together with at least three GND pins allows a maximum of 5V/6A. There is one 12V pin, allowing max 12V/2A. For larger currents, you must use the KL3 power connector.

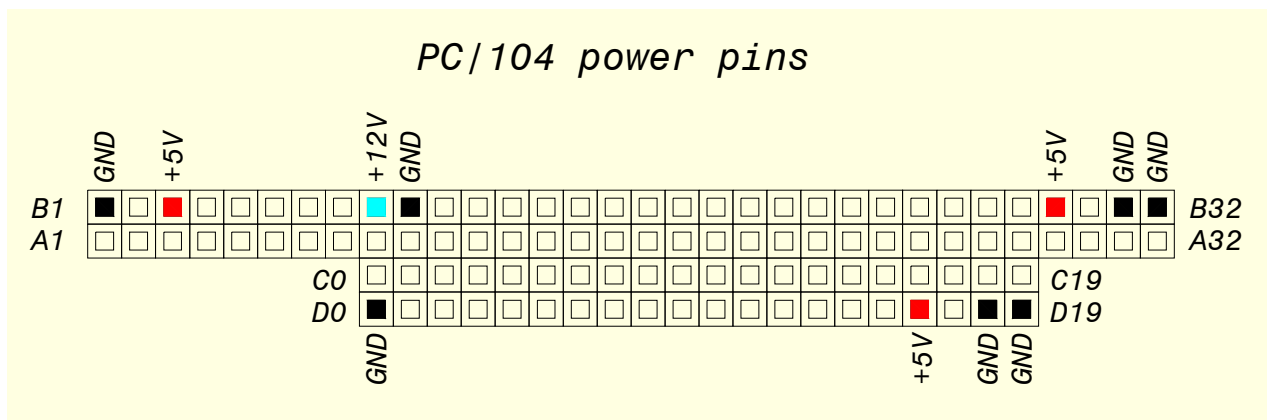

The ATX signals (+5V STB, PS_ON and PWR_GOOD) are not available in the PC/104 connector. The PC/104 bus is also used for software UPS status and power-off, see the *UPS Control* section. The software interface uses the following signals:

PC/104 pin	Function
A2	SD7
A3	SD6
A4	SD5
A5	SD4
A6	SD3
A7	SD2
A8	SD1
A9	SD0
A11	AEN
A22	SA9
A23	SA8
A24	SA7
A25	SA6
A26	SA5
A27	SA4
A28	SA3
A29	SA2
A30	SA1
A31	SA0
B13	IOW#
B14	IOR#

System temperature

The PV-5127 has a temperature measuring circuit that can control an external fan and heater, and prevent the CPU from starting if the temperature is too low or too high. It monitors the system temperature as long as +5V STB is on.

As system temperature sensor, you can use the onboard sensor, or an external sensor of type Infineon KTY 11-5 connected to J2 (labelled "Ext. sensor"). If you don't want any temperature control, you can also configure it to a simulated 10°C, which effectively disables the temperature control.

The circuitry checks for four different temperature ranges: *too cold*, *cool*, *warm*, and *too hot*.

Range	Thresholds
<i>Too cold</i>	Below (0°C, 3°C)
<i>Cool</i>	Between (0°C, 3°C) and (15°C, 18°C)
<i>Warm</i>	Between (15°C, 18°C) and (47°C, 55°C)
<i>Too hot</i>	Above (47°C, 55°C)

There is hysteresis when moving between the ranges. The notion (0°C, 3°C) denotes the lower and upper hysteresis levels, so that the change from *too cold* to *cool* happens when the temperature rises above 3°C, but to change from *cool* to *too cold*, the temperature must fall below 0°C. Similarly for the threshold between *cool* and *warm* (at 15°C and 18°C), and between *warm* and *too hot* (at 47°C and 55°C).

For testing purposes, the *too cold* and *too hot* ranges can be simulated. To simulate *too cold*, mount a jumper on J2 instead of a sensor. To simulate *too hot*, leave both J2 and ST3 unconnected.

The temperature ranges are used for these functions:

Range	CPU start allowed	Heater	Fan	Critical alarm	Cold LED	Hot LED
<i>Too cold</i>	No	On	Off	No	Flashing	Off
<i>Cool</i>	Yes	Off	Off	No	Off	Off
<i>Warm</i>	Yes	Off	On	No	Off	Off
<i>Too hot</i>	No	Off	On	Yes	Off	Flashing

Note that the heater and fan outputs are logical outputs that become 3.3V when they are active. If necessary, the user must provide driving circuitry to drive an actual heater and fan. The positions of the two outputs in CN2 are shown here.

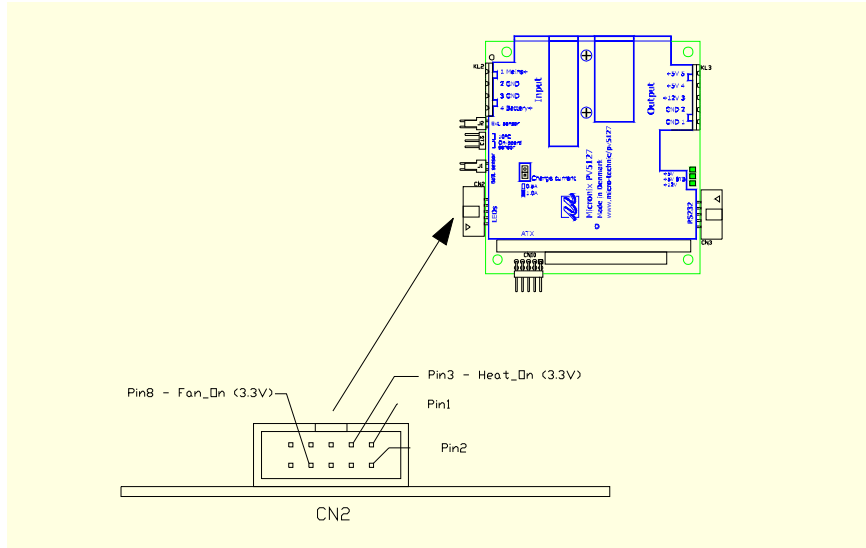

If the temperature is *too cold* or *too hot*, the CPU cannot be turned on until it changes to *cool* or *warm*. But if it the CPU is on, and the temperature later changes to *too cold* or *too hot*, the CPU continues running.

If the temperature changes to *too hot* and you are using UPS monitoring software with the RS232 status signals, a “critical alarm” (mains failure and low battery) is signalled, prompting the monitoring software to shut down immediately. UPS monitoring software that reads status information through the PC/104 can also detect this condition and react accordingly.

UPS Control

The PV-5127 provides several methods for the CPU to get UPS status information, and to turn off power. The CPU can get status information through the RS232 and the PC/104 interface, and it can perform a software-controlled power-off through the ATX PS_ON signal, through an RS232 signal, and through the PC/104 interface.

PS_ON signal

Two of the ATX functions that are supported in PV-5127 are: +5V STB and PS_ON. These signals are placed in connector CN10.

In the figure below, the relationship between Mains OK, PS_ON and +5V STB is illustrated.

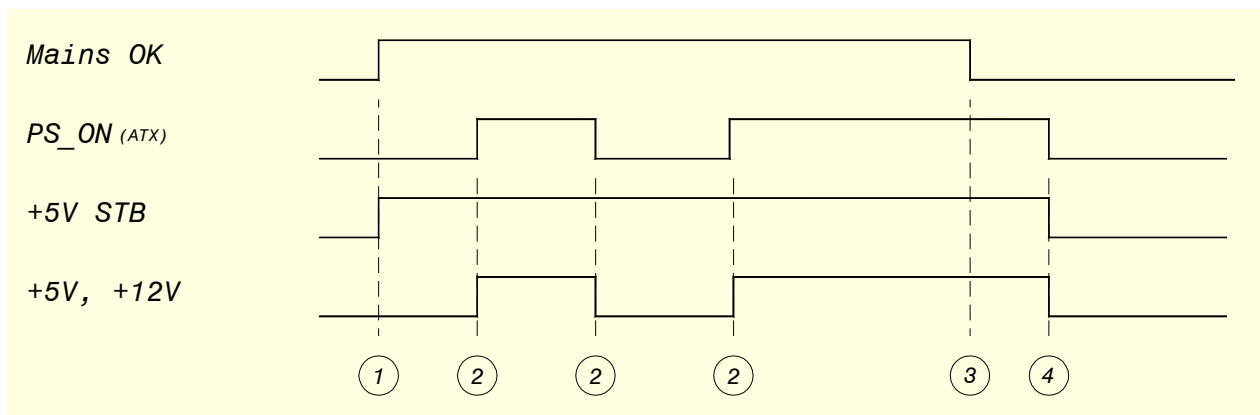

In this figure, the system temperature and the battery voltage are assumed to be OK. For the full details involving these conditions, please see the *ATX and Softoff state machines* section.

1. 5V STB turns on when mains turns on.
2. The CPU can turn itself on and off using PS_ON, and since mains is on, the +5V STB also stays on.
3. When mains disappears while the CPU is on, it continues running on battery.
4. When the CPU turns itself off while mains isn't present, everything including +5V STB is turned off, to conserve battery power. It stays off until mains comes back.

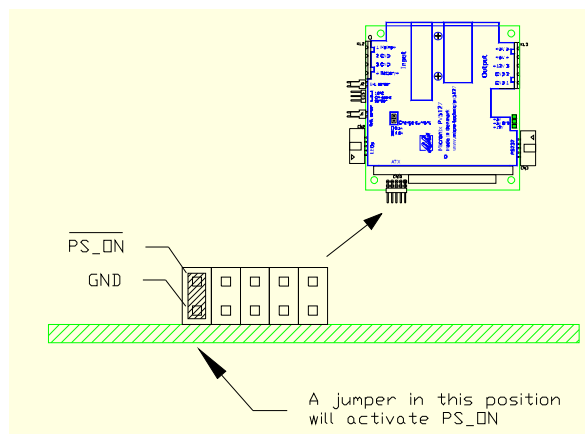

RS232

The PV-5127 has a connector (CN3, labelled “RS232”) that can be connected to an RS232 port on the CPU. The PV-5127 provides two handshake outputs with status information, and one handshake input for controlling shutdown. The RxD and TxD signals are not used, the only used signals are Ground and the three handshake signals. The three signals are compatible with the “simple signalling” or “basic signalling” protocol used by other UPS units.

The 10-pin connector, CN3 is designed to be used with a simple ribbon cable ending in a DB9 female connector to be plugged into a DB9 male RS232 connector on the CPU.

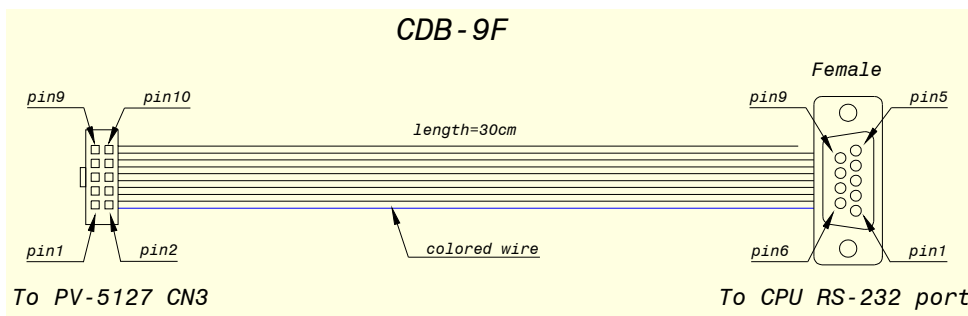

The signals use normal RS232 voltage levels. Inactive (‘0’) = -10V, active (‘1’) = +10V. In the table shown inputs are indicated by (i) and outputs by (o).

PV-5127 CN3	
Pin	Function
1	Battery low(o)
2	
3	
4	UPS_active(i), see note
5	
6	Mains failure(o)
7	Shutdown(i)
8	
9	GND
10	

CPU RS232 DB9		
Pin	RS232	Function
1	CD	Battery low(i)
2		
3		
4	DTR	Shutdown(o)
5	GND	GND
6		
7	RTS	UPS_active(o)
8	CTS	Mains failure(i)
9		

Note: The UPS_active signal is currently unused by the PV-5127.

RS232 Status signals

The *Battery low* and *Mains failure* signals together can tell three different states:

Mains failure	Battery low	Status
0	0	Running normally on mains power.
1	0	Mains alarm, running on battery. The CPU is advised to shut down if mains power doesn't come back within reasonable time. This time should be configured in the UPS monitoring software.
1	1	Critical alarm. The CPU is advised to shut down immediately. This happens in two situations: <ul style="list-style-type: none"> • During mains failure and the battery is critically low. • When the system is <i>too hot</i>.

RS232 Shutdown signal

When the CPU activates the Shutdown signal for one second, the PV-5127 immediately turns off the +5V and +12V power, and, if mains is not present, also the +5V STB. Pulses shorter than one second have no effect. For details, please see the section *ATX and Softoff state machines*.

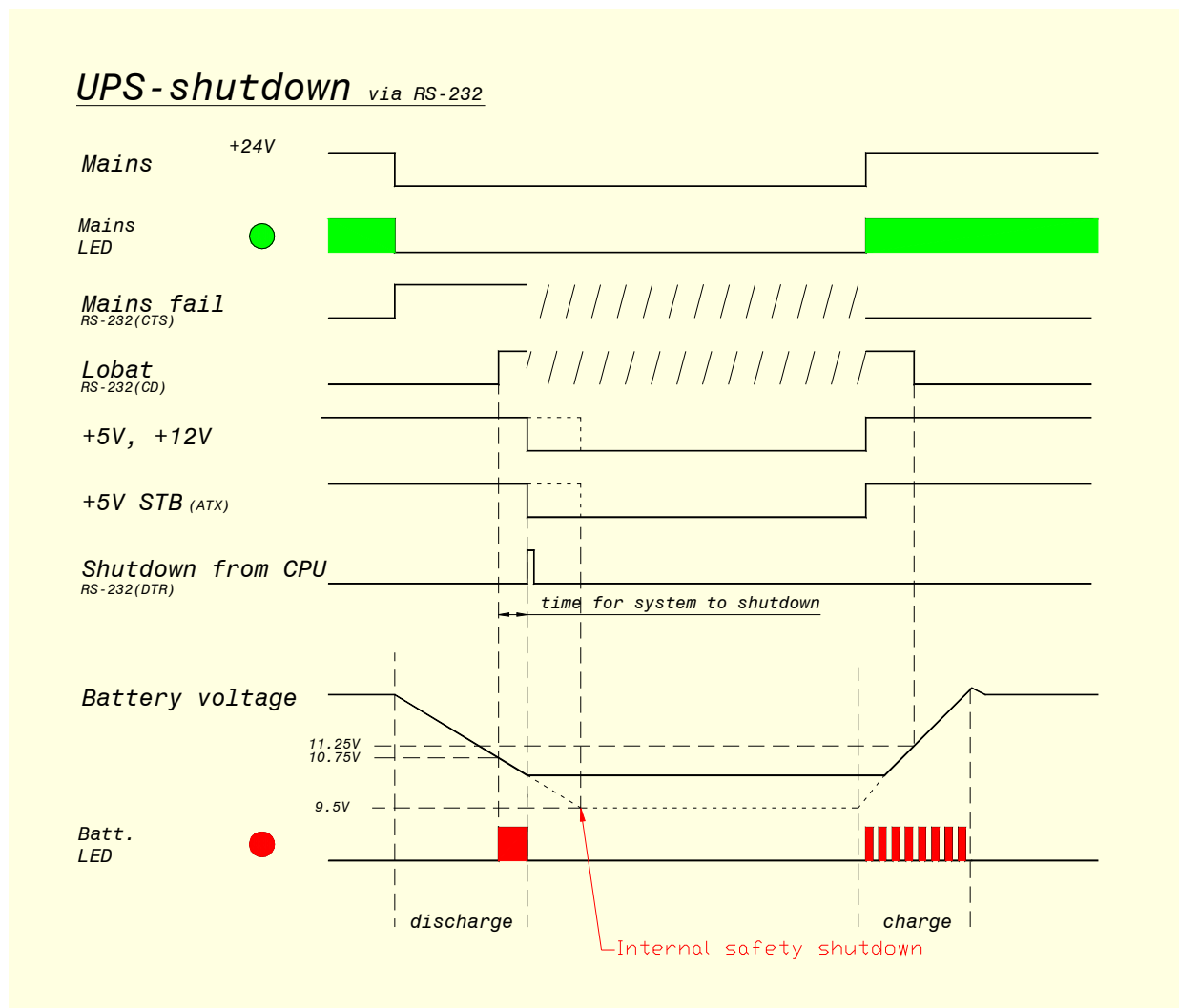

PC/104 interface

The PV-5127 has a software interface where the CPU can read status information and perform a power-off through the PC/104 bus. The power-off can be delayed up to 253 seconds, so that the UPS monitoring can start the delayed power-off, then start a shutdown of the operating system, and the actual power-off happens after the operating system has finished shutting down.

When a delayed power-off has been initiated, the software can later cancel or modify it. This means that the delayed power-off can be used as a software watchdog: If the software e.g. once every second starts a power-off specifying a delay of 10 seconds, the system is continuously kept on. If, because of a software error, the refreshing of the delayed power-off stops, the PV-5127 will power off the system in 10 seconds. If mains is present and the system temperature is OK, the PV-5127 will turn on again two seconds later, ensuring a clean reboot.

This interface is used by the PV-5127 UPS minidriver for Windows 2000/XP. You only need the following information if you want to write your own UPS monitoring or watchdog software.

To the CPU, the PV-5127 appears as a fixed block of eight I/O addresses at 250h-257h. It doesn't use any memory addresses, IRQs, or DMA channels.

Address	Read/write	Function
250h	read only	SIGNATURE
251h	read only	STATUS
252h	read only	BAT_STATUS
253h	read only	RS232_STATUS
254h	read/write	SHUTDOWN
255h	-	Reserved
256h	-	Reserved
257h	-	Reserved

SIGNATURE (port 250h, read only):

This port always reads as 37h. Software can read this register to verify the presence of a PV-5127 adapter.

STATUS (port 251h, read only): 0000b**m**s**s**

This port contains the following read-only status information bits.

ss (STATUS bit 1-0): System temperature, according to the internal or external system temperature sensor.

ss=00: *Too cold*

ss=01: *Cool*

ss=10: *Warm*

ss=11: *Too hot*

m (STATUS bit 2): Mains present.

m=0: *Mains voltage not present, running on battery*

m=1: *Mains voltage present*

b (STATUS bit 3): Battery present.

b=0: *Battery not present (empty or disconnected)*

b=1: *Battery present*

BAT_STATUS (port 252h, read only): nn0cctvv

This port contains the following read-only battery status information bits.

vv (BAT_STATUS bit 1-0): Battery voltage. See the section *Battery monitor and charger*.

vv=00: *Empty or low*

vv=01: *Medium*

vv=10: *Full*

vv=11: *Disconnected*

t (BAT_STATUS bit 2): Battery temperature, according to the battery temperature sensor input. When using the PV-1075 NiMH battery module, the sensor should be disconnected, and this bit always reports *battery too hot*.

t=0: *Battery temperature OK, charger enabled*

t=1: *Battery too hot, charger disabled*

cc (BAT_STATUS bit 4-3): Charger status.

cc=00: *Charger off*. When using the PV-1075, the charger is always off.

cc=01: *Reserved*

cc=10: *Charger on, trickle charging*

cc=11: *Charger on, fast charging*

nn (BAT_STATUS bit 7-6): Battery type. With the current firmware, the only possible value is 01.

nn=00: *Reserved*

nn=01: *Lead-Acid, or PV-1075 NiMH battery module*

nn=10: *Reserved*

nn=11: *Reserved*

RS232_STATUS (port 253h, read only): uuuu0000

This port contains the following read-only status bits. They reflect the status of the pins in the RS232 connector, whether input from the CPU, or output by the PV-5127. All four signals are active high, i.e. 1=signal active, 0=signal inactive. Note that RTS (UPS_active) has no function, apart from being readable in this port.

RS232_STATUS bit 4: CD (Lobat). Output from the PV-5127.

RS232_STATUS bit 5: CTS (Mainsfail). Output from the PV-5127.

RS232_STATUS bit 6: RTS (UPS_active). Input into the PV-5127.

RS232_STATUS bit 7: DTR (Shutdown). Input into the PV-5127.

SHUTDOWN (port 254h, read/write):

This port holds the current state of the Softoff state machine. Please see the section *ATX and Softoff state machines*. Possible values are:

00h: SOFT_OFF (first half of 2-second delay)
FEh: SOFT_ON
FFh: SOFT_OFF (second half of 2-second delay), or SOFT_TEMPBAD
Other values: SOFT_DELAY, delayed shutdown in progress. value = remaining seconds until SOFT_OFF

Software normally won't read the values 00h and FFh since the 5V+12V is off at this time. Writing 00h will turn off power immediately, and it will stay off for at least two seconds. You shouldn't write FFh since this will turn power off for only one second, and this might not be enough for a CPU to reboot cleanly. Writing FEh will cancel a delayed shutdown in progress. Writing other values will initiate (or modify) a delayed shutdown, with the value being the number of seconds until SOFT_OFF.

Software compatibility

Windows NT 4.0: The PV-5127 RS232 interface is directly compatible with the Windows NT 4.0 UPS service, using the CDB-9F cable. It can monitor the three statuses (Normal, Mains alarm, Critical alarm), and use the RS232 Shutdown signal to power off.

Windows 2000 and XP: The UPS service in these operating systems can monitor the three statuses (Normal, Mains alarm, Critical alarm) through RS232, but it cannot power off the PV-5127 with the Shutdown signal. This is because the UPS service is terminated during shutdown, so it cannot activate the Shutdown signal when shutdown is complete.

To power off the PV-5127 after a shutdown under Windows 2000 and XP, you must use either the PS_ON signal with an ATX compatible CPU, or the PC/104 interface. Using the PS_ON signal ensures that power is turned off exactly when the operating system has finished shutting down. The PC/104 interface is used by the PV-5127 UPS minidriver available at <http://www.micro-technic.com/pv5127/>. This method does not use an RS232 port or cable.

Linux: Several UPS monitoring daemons exist which use the "simple" or "dumb" signalling protocol on a serial port. Examples are:

- *apcupsd* (<http://www2.apcupsd.com>): When using the CDB-9F cable, you should specify UPSCABLE 940-0020B.
- *Network UPS Tools* (<http://www.networkupstools.org>): When using the CDB-9F cable, you should specify genericups upstype=2.
- Other daemons: Make sure that you use the right handshake signals since no single standard exists for which handshake are used for which function, and adapt either the software configuration or the cable accordingly.

With some UPS hardware, you can experience a "deadlock" problem if mains power comes back after the UPS monitoring software has decided to shut down the operating system. This happens if the UPS monitoring software is unable to turn off power after the operating system has finished shutting down, because mains power has come back. This cannot happen with the PV-5127 because it always turns off power for at least two seconds after a power-off command through RS232 or PC/104, even if mains power is present.

Battery monitor and charger

Battery voltages

The PV-5127 monitors the voltage of the battery as long as the main DC/DC converter is on. The voltage status controls the charger, the RS232 alarm output, the battery LED, and it can be read through PC/104. The possible ranges are:

Range	Thresholds
<i>Empty</i>	Below 9.5V
<i>Low</i>	Between 9.5V and (10.75V, 11.25V)
<i>Medium</i>	Between (10.75V, 11.25V) and (13.0V, 14.7V)
<i>Full</i>	Between (13.0V, 14.7V) and 15.0V
<i>Disconnected</i>	Above 15.0V

There is hysteresis when moving between some of the ranges. The notion (10.75V, 11.25V) denotes the lower and upper hysteresis levels, so that the change from *low* to *medium* happens when the voltage rises above 11.25V, but to change from *medium* to *low*, the voltage must drop below 10.75V.

When *empty*, and running on battery, power is immediately turned off to protect the battery against complete discharge. This is the safety shutdown feature. *Empty* can also mean that no battery is connected.

When *low*, and running on battery, a Critical alarm is reported through RS232.

The *medium* and *full* ranges control the charging mode, see below.

The *disconnected* state happens when the charger is on, and there is no battery connected.

Lead-acid charger

The PV-5127 has an integrated lead-acid battery charger that will maintain the UPS battery as long as the mains voltage is present. The battery charger has three modes of operation: *Fast charge*, *trickle charge*, and *off*.

In the *fast charge* mode, the battery charger will deliver a constant current to the battery as long as the battery voltage has not reached 14.7V. This current can be programmed by a jumper at ST1.

ST1 installed	ST1 removed
Fast charge current=1A	Fast charge current=0.5A

After reaching 14.7V, the charger goes into *trickle charge* mode. In this mode, the battery is supplied with a constant voltage of 13.6V. When the battery voltage falls below 13.0V, the charger returns to *fast charge* mode.

Charging a lead-acid battery while it is too hot may damage it. The PV-5127 has an input, J1, for connecting an external battery temperature sensor. The sensor, if used, should be physically

mounted directly on the battery. The charging is disabled when the temperature according to this sensor rises above 55°C, and enabled when it falls below 45°C. The J1 input has the following function:

Installed on J1	Charger function
Nothing	Disabled. See note.
A jumper	Enabled (factory default)
A KTY11-5 sensor	Enabled when not too hot

Note: When using the PV-5127 with a PV-1075 NiMH battery module, you must disable the PV-5127 charger by leaving J1 unconnected.

You can connect a Battery LED to the CN2 connector. The LED shows these statuses:

Battery LED	Meaning
Off	Battery voltage OK (<i>medium</i> or <i>full</i>). If mains is present and the charger is enabled, the charger is in <i>trickle charge</i> mode, otherwise it is <i>off</i> .
Flashing	Charger is in <i>fast charge</i> mode.
Steady on	Battery error. This indicates that the battery is either <i>empty</i> , <i>low</i> , or <i>disconnected</i> .

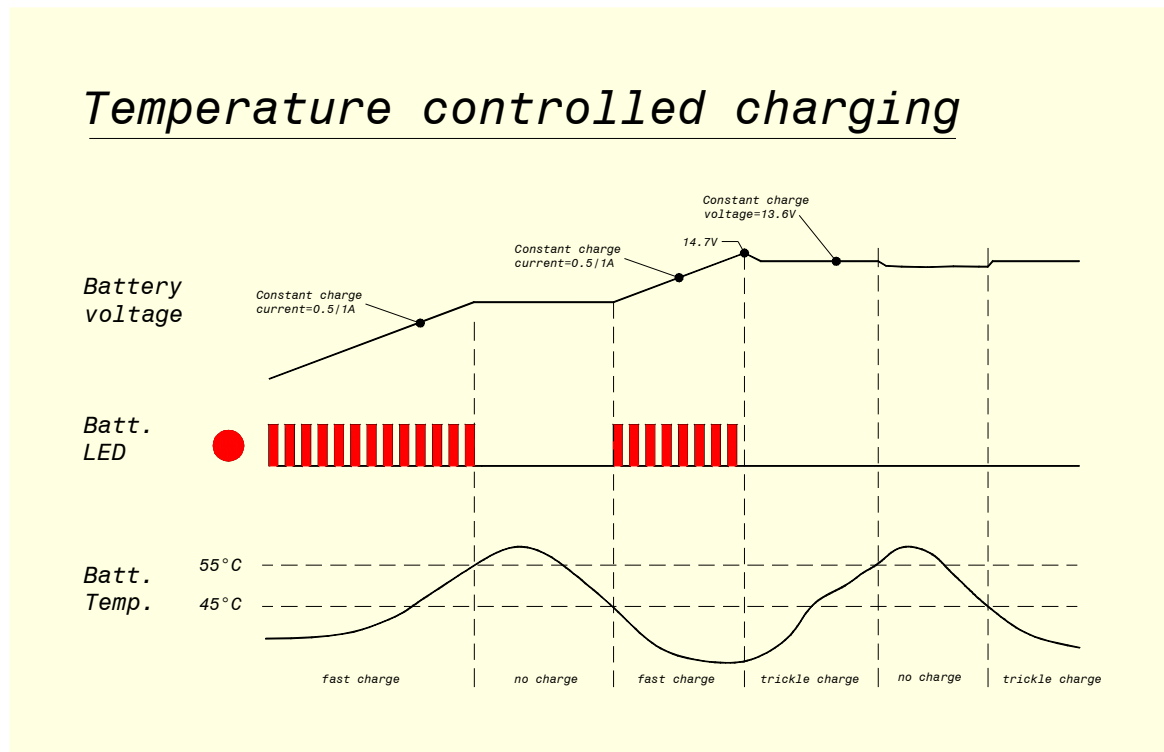

ATX and Softoff state machines

The PV-5127 provides several ways to turn on/off power. ATX compatible CPUs can turn themselves on and off using PS_ON, and UPS monitoring software on CPUs without PS_ON can turn off using either a RS232 handshake signal or a software command through the PC/104 bus. Regardless of the method, the system temperature ensures that the CPU can only be turned on when the system temperature is OK, but it is allowed to stay on if the temperature later becomes too cold or too hot. The system temperature circuit can be bypassed using a jumper that effectively tells the PV-5127 that the temperature is always OK.

The main DC/DC converter and 5V STB

The main DC/DC converter converts the input voltage (from mains or the backup battery) to 5V. The output of the converter is directly connected to the 5V STB output, so whenever the converter is on, the 5V STB is present. It also powers the internal control logic. When off, the power consumption is minimal.

The output of the converter is also connected, through a power switch, to the main 5V output and (through a step-up DC/DC converter) to the 12V output. The power switch controls when to turn on the 5V+12V outputs.

The main DC/DC converter turns on when mains appears, and stays on as long as mains is present. When the converter is on, the CPU can turn on and off the 5V+12V output using PS_ON, depending on temperatures etc.

When mains disappears, the converter stays on as long as the 5V+12V output is on, and the battery is OK (>9.5V). That is, when running on battery, the converter is turned off when the CPU turns itself off (to conserve battery capacity until mains comes back), or when the battery is empty (to protect the battery against deep discharging).

The 5V+12V outputs

The power switch, which turns on and off the 5V+12V outputs, is controlled by two state machines implemented in the control logic – the ATX on/off state machine, and the Softoff state machine. Both state machines must be in their “on” state for the power switch to turn on. When either state machine goes to an “off” state, the 5V+12V outputs turn off, and if mains is not present, the main DC/DC converter also turns off.

The ATX on/off state machine

The ATX on/off state machine has two states: ATX_OFF and ATX_ON. Only in the ATX_ON state can the 5V+12V outputs be turned on.

The state machine is controlled by the PS_ON input (located in the CN10 connector), and the system temperature status. PS_ON is active low – it is *active* when pulled low to 0V, and *inactive* when high or left floating.

- The state machine starts up in ATX_OFF when the main DC/DC converter starts.
- It changes to ATX_ON when PS_ON is active **and** the system temperature is OK (*cool* or *warm*). This means that the CPU cannot turn itself on when the temperature is not OK (*too cold* or *too hot*).
- It stays in ATX_ON as long as PS_ON is active. Even if the system temperature becomes *too cold* or *too hot*, it stays in ATX_ON, as long as PS_ON is active. This means that the CPU won't suddenly be turned off if the temperature becomes bad (but it can decide to do a controlled shutdown and power off when it sees the temperature status).
- When PS_ON goes inactive, it changes to ATX_OFF.

If your CPU cannot control the PS_ON input, you can make it permanently active by placing a jumper in CN10.

The Softoff state machine

The Softoff state machine is intended for use with UPS monitoring software, such as the Windows 2000/XP UPS service. The Softoff state machine is controlled by the RS232 Shutdown (DTR) signal, the system temperature status, and software commands through the PC/104 bus. This state machine is useful when your CPU does not support the PS_ON signal. With this state machine, you can perform a shutdown using an RS232 handshake signal (see the section *RS232*), and through a software command through the PC/104 bus (see the section *PC/104 Interface*). If you leave the RS232 DTR unconnected, it is by default inactive.

The state machine has four states: SOFT_ON, SOFT_DELAY, SOFT_OFF and SOFT_TEMPBAD. SOFT_ON and SOFT_DELAY are the “on” states, i.e. only in these states can the 5V+12V be turned on. SOFT_OFF and SOFT_TEMPBAD are the “off” states, where the 5V+12V is guaranteed to be off.

It can be illustrated like this:

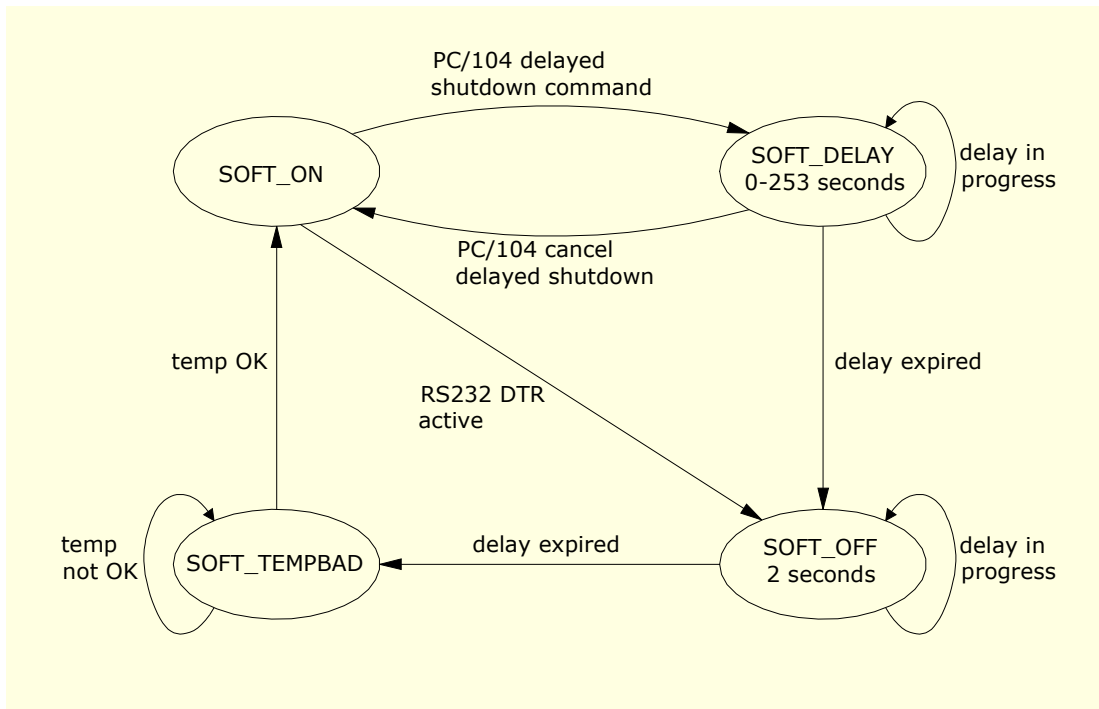

- The state machine starts up in SOFT_TEMPBAD when the main DC/DC converter starts. In this state, the 5V+12V cannot be turned on. It stays in this state as long as the system temperature is *too cold* or *too hot*.
- SOFT_ON: This is the normal “on” state. The RS232 DTR (Shutdown) is monitored, and if it is active for one second, power is turned off by going to SOFT_OFF. Pulses on DTR shorter than one second are ignored. In SOFT_ON, the CPU can issue a delayed shutdown command through the PC/104 bus.
- SOFT_DELAY: The 5V+12V is still on, but the delayed shutdown timer is running. The delay can be cancelled by software, returning to SOFT_ON.
- SOFT_OFF: The 5V+12V is turned off for two seconds, ensuring that the CPU is cleanly rebooted after it has decided to shut down, even if mains isn’t present, the main DC/DC converter is also turned off, so everything stays off until mains comes back.
- SOFT_TEMPBAD: If mains is present, it moves from SOFT_OFF to SOFT_TEMPBAD after two seconds. If the system temperature is OK (*cool* or *warm*), it then moves immediately to SOFT_ON. If the system temperature is either *too cold* or *too hot*, it stays in SOFT_TEMPBAD until either the temperature becomes OK, or mains disappears (whereby everything is turned off until mains comes back).

Note that the PV-5127 does not have a very accurate clock. You should expect deviations of $\pm 10\%$ from the nominal times in SOFT_DELAY and SOFT_OFF.

Technical data

Power supply:	
Input voltage:	
PV-5127-S:	18-35Vdc (with UPS and charger)
PV-5127A-S:	10-35Vdc (without UPS and charger)
Output Voltage 1:	+5Vdc, 8A
Ripple/noise:	+/-100mV
Line regulation:	+/-1%
Load regulation:	+/-5%
Output Voltage 2:	+12Vdc, 3A
Ripple/noise:	+/-150mV
Line regulation:	+/-1%
Load regulation:	+/-5%
Output Voltage 3:	+5V Standby, 1A
Output power:	75W, max
Efficiency:	5V: 91%, 12V: 81%
Overload protection:	Short circuit and overload protected
UPS/Battery Charger:	
Battery type:	12V Lead Acid or NiMH (PV-1075)
Lead Acid charge:	Fast charge: Constant current (0.5 or 1A) Trickle charge: Constant voltage (13.6V)
Battery protection:	Input for temperature sensor.
Temperature control:	Internal or external ambient temperature sensor Logical outputs for external fan and heater (3.3V when on) Alarm to CPU when temp. too high(via "RS232" and PC/104)
ATX signals:	Input: PS_ON Outputs: PWR_GOOD, +5V Standby
"RS232" Interface:	
Handshake signals:	"Mains failure", "Battery Low", "Shutdown"
High temperature alarm:	Activates "Mains failure" and "Battery Low"
Software:	Supported by Windows NT and Linux
PC/104 Interface:	
Power:	+5V, +12V
Status:	Software readable mains, battery, and temperature status
Shutdown:	Software shutdown, delayed 0-253 sec.
Software:	UPS service for Windows 2000 and XP available
Logic outputs (Fan_ON, Heat_ON, and PWR_GOOD):	
V _{OH} – Output high voltage:	min. 2.4V @ -4.0mA
V _{OH} – Output high voltage:	typ. 3.3V @ 0mA
V _{OL} – Output low voltage:	max. 0.4V @ 8.0mA

Environmental specifications:	
Operating temperature:	-20°C to +70°C at 0.5 m/s airflow
Storage temperature:	-40°C to +85°C
Humidity:	20 to 90% non-condensing
Cyclic humidity:	ETS 300 019-2-5 or equal
Vibration:	10-1000 Hz sinus and random @ 1-1.5G RMS EN
Sustained vibration:	60068-2-34 & 60068-2-36
Shock:	IEC 60068-2-27 & 60068-2-29
Size: (W x L x H):	90 x 96 x 15mm

Mechanical layout

The schematic on this page shows the dimensions for PV-5127.
All dimensions are in mm.

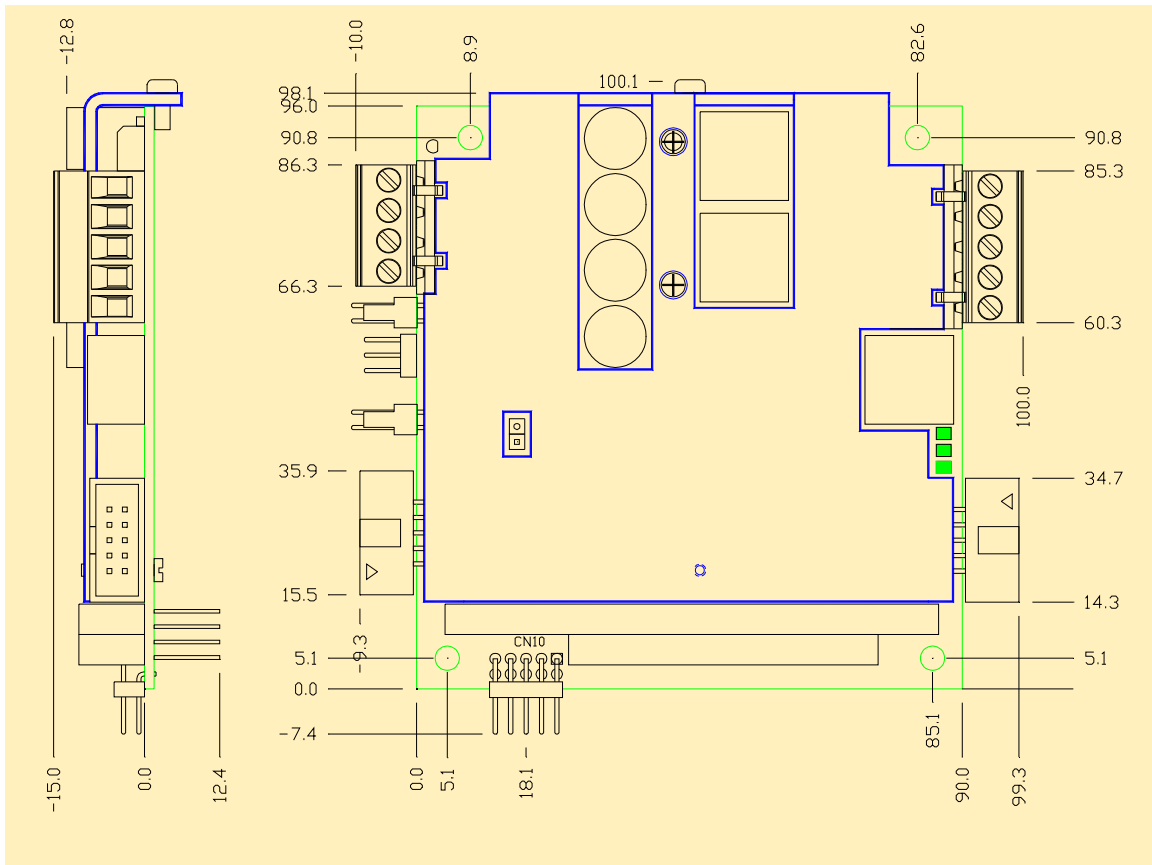

Installation guide

Precautions to ESD

Please note that the Micronix PV modules must be handled with respect to ESD (Electrostatic Discharge). Electrostatic Discharge to the PV modules must be avoided.

Before removing the module from the protection bag, the user must be discharged using a grounded wrist ribbon.

Settings and connections

ST1

To set the fast charge current to 1A, install a jumper at ST1 (factory default). To set the fast charge current to 0.5A, remove jumper at ST1.

J1

Connect an external temperature sensor at J1 (i.e. PV-5127-TW40) if the battery temperature is to be supervised during the charging process. The battery temperature control can be disabled by installing a jumper at J1 (factory default). Leave ST1 unconnected when PV-5127 is used with a PV-1075 battery module. See section *Connectors* and *Battery monitor and charger*.

ST3

Connect a jumper in position 'On-board sensor' if the system temperature is to be measured by the on-board sensor. If the system temperature is to be measured by an external sensor, leave ST3 unconnected. To disable the system temperature control, install a jumper in the position '10°C' (factory default).

J2

Connect an external temperature sensor at J2 (i.e. PV-5127-TW40) if the system temperature is to be supervised by an external sensor. Otherwise leave J2 unconnected. See section *Connectors* and *System temperature*.

CN2

If external LED indicators or the heater and fan control outputs are used, connect these through CN2. Otherwise leave CN2 unconnected. See section *Connectors*.

CN3

If the 'simple signalling' protocol is to be used for the UPS control, connect a suitable cable (i.e. CDB-9F) between CN3 and a COM port on the CPU. Otherwise leave CN3 unconnected. See section *UPS Control*.

CN10

If your CPU has a 5V Standby power input and a PS_ON output, connect them to the corresponding pins in CN10 (ATX). Otherwise place a jumper on the two leftmost pins in CN10 to permanently activate PS_ON (factory default). See section *Connectors* and section *UPS Control*.

KL2

Connection of mains and battery voltage are made via KL2 as shown in the table:

Connection in KL2	Function
1	Mains+ in
2	Mains- in
3	Battery- in
4	Battery+ in

Connect mains input to pin 1 and 2. To use a lead-acid backup battery, connect it to pin 3 and 4, otherwise leave pin 3 and 4 unconnected. To use a NiMH (Nickel Metal Hydride) battery for back-up, a Micronix PV-1075 can be integrated in the PC/104 stack. In this case, see documentation supplied with PV-1075 for connection of mains and battery.

KL3

Output power can be supplied from connector KL3. This should be used if the output current exceeds the PC/104 connector limits, see section *PC/104 connector (CNI)*, or if you need power for devices that are not powered through the PC/104 bus.

Connection number in KL3	Function
1	GND
2	GND
3	+12V out
4	+5V out
5	+5V out

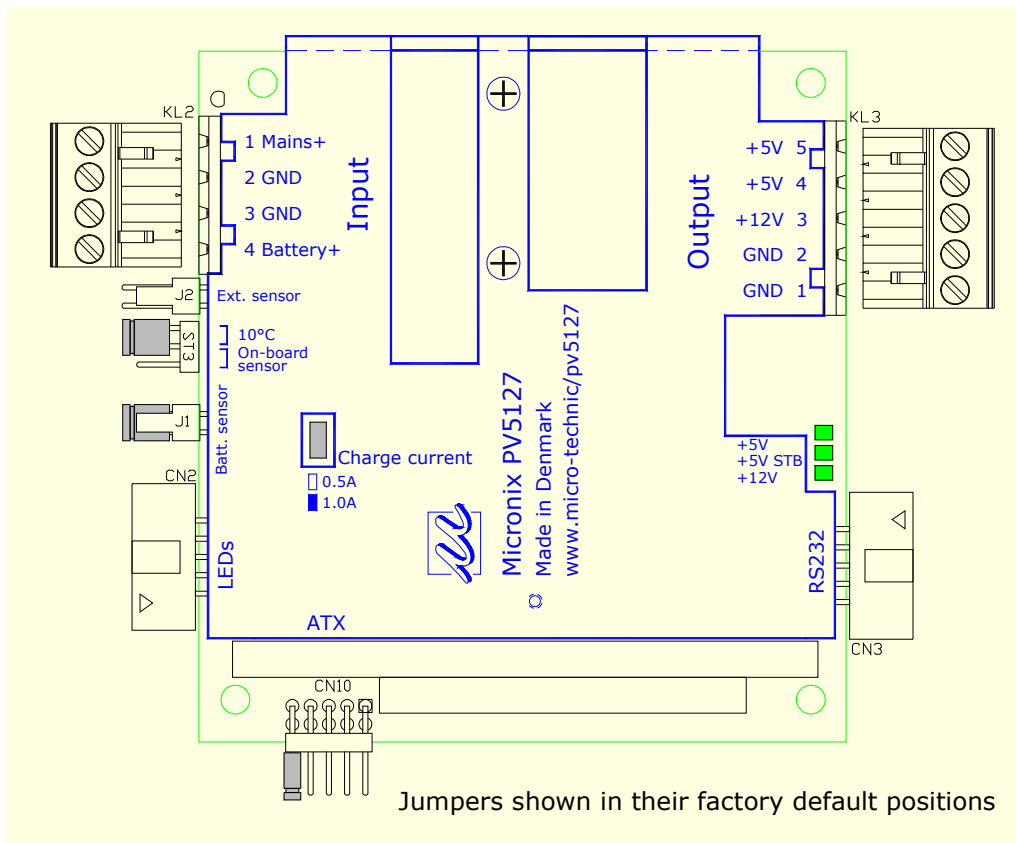

Thermal considerations

When installing the Micronix PV-5127 in a PC/104 stack, some considerations about convection must be made. For the power supply to work properly, certain temperature limits must not be exceeded. Several factors will affect the temperature raise in the PV-5127:

- the delivered power
- the convection inside the cabinet
- the input voltage (mains) and
- the ambient temperature

Tests have shown that if the temperature at the top of the electrolytic capacitors do not exceed 105°C, the PV-5127 is thermally safe. This table shows the relationship between Uin and Tcap:

Uin[V]	Tcap[°C]	Tamb max.[°C]	Pout[W]
10	67	60	75
18	72	55	75
24	74	53	75
30	86	41	75

All figures in the table match an ambient temperature equal to 22°C without forced cooling. A raise in ambient temperature must be added to Tcap. This gives the max. ambient temperature: Tamb max. = (105 –Tcap) + 22. These figures are given in the table.

If the PV-5127 is placed in an ambient temperature that is higher than indicated in the table, the system integrator must arrange forced cooling. Temperature experiments have shown that a min. airflow parallel to the surface of the heat sink of 0.5m/s is adequate for max. load at ambient temperatures up to 84°C. For durability reasons, it is recommended not to use PV-5127 at ambient temperatures exceeding 70°C at full load.

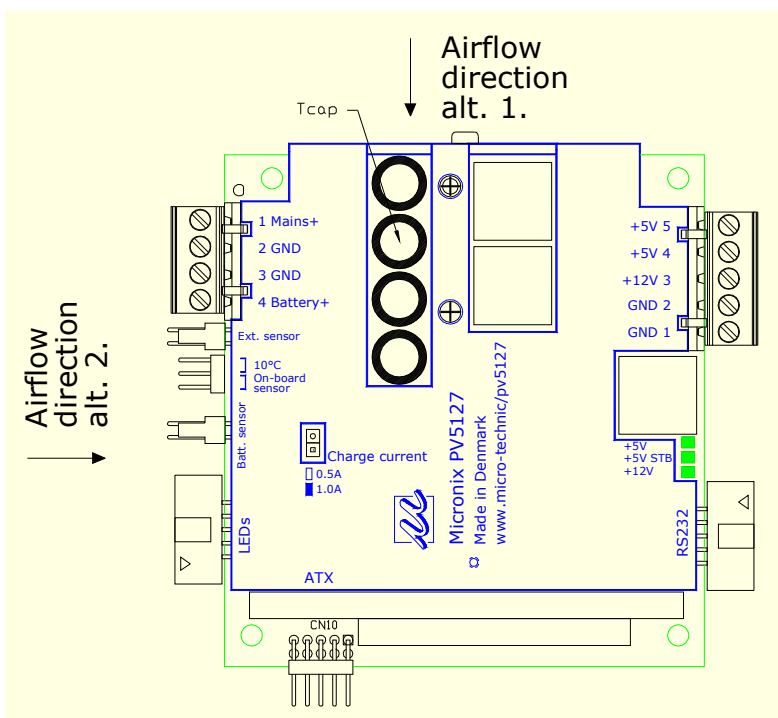

Differences between PV-5127 and PV-5127A

The PV-5127 is available in a version without UPS and battery charger. The ordering code for this product is PV-5127A. These things are different in this version:

- The mains voltage range is nominally 10-35V instead of 18-35V. The mains monitor reports mains failure at mains voltage below 9.0V and mains OK at above 9.5V, instead of 16.5V and 17.5V, respectively.
- The battery charger is omitted.
- The input selector circuit is omitted.
- J1 for battery temperature sensor is omitted.
- CN3 for “RS232” UPS communication is omitted.

Block diagram of the PV-5127A

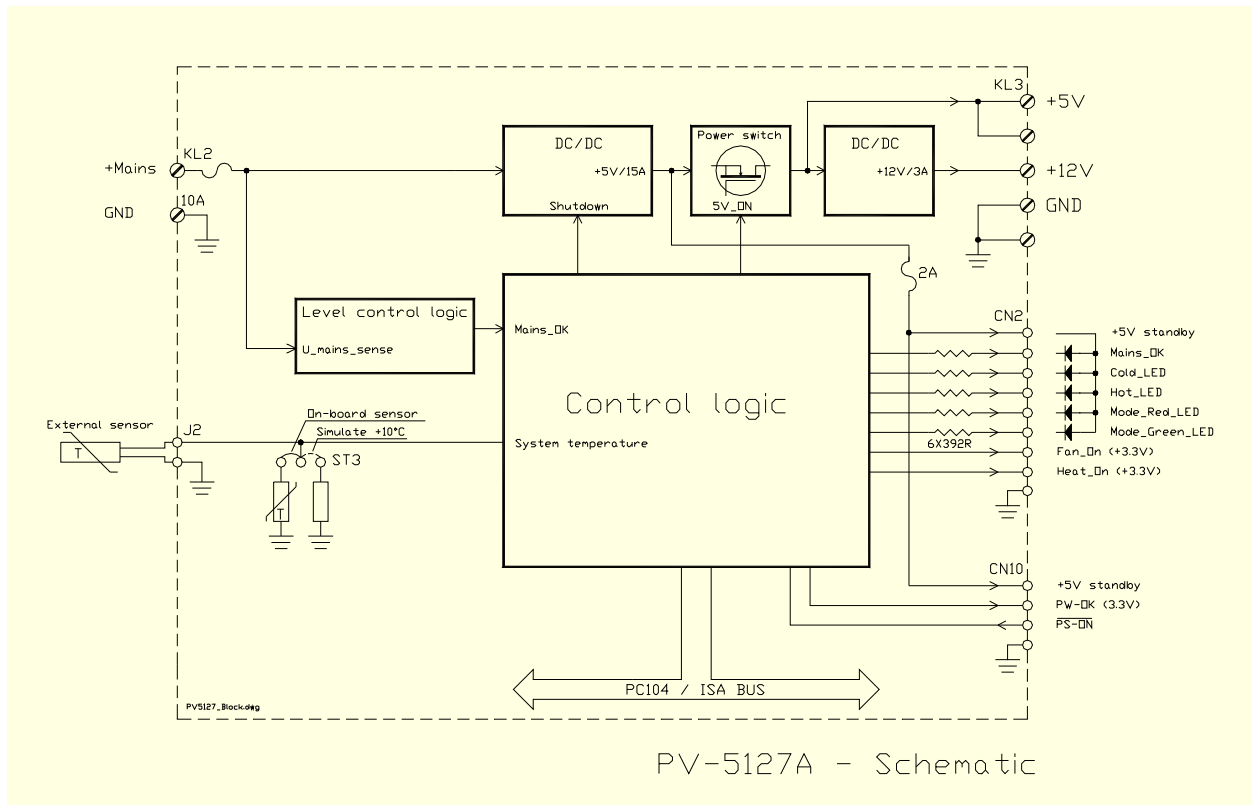

Free Manuals Download Website

<http://myh66.com>

<http://usermanuals.us>

<http://www.somanuals.com>

<http://www.4manuals.cc>

<http://www.manual-lib.com>

<http://www.404manual.com>

<http://www.luxmanual.com>

<http://aubethermostatmanual.com>

Golf course search by state

<http://golfingnear.com>

Email search by domain

<http://emailbydomain.com>

Auto manuals search

<http://auto.somanuals.com>

TV manuals search

<http://tv.somanuals.com>