

5000E

User's Manual

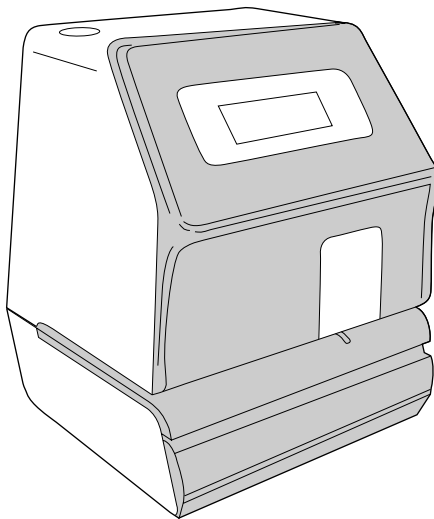

Lathem Time Corporation

WARNING

This equipment has been tested and found to comply with the limits for a Class A digital device, pursuant to Part 15 of FCC Rules. These limits are designed to provide reasonable protection against harmful interference when the equipment is operated in a commercial environment. This equipment generates, uses, and can radiate radio frequency energy and, if not installed and used in accordance with the instruction manual, may cause harmful interference to radio communications. Operation of this equipment in a residential area is likely to cause harmful interference in which case the user will be required to correct the interference at his or her own expense.

Caution: Changes or modifications not expressly approved by the party responsible for compliance could void the user's authority to operate the equipment.

THIS DIGITAL APPARATUS DOES NOT EXCEED THE CLASS A LIMITS FOR RADIO NOISE EMISSIONS FROM DIGITAL APPARATUS AS SET OUT IN THE RADIO INTERFERENCE REGULATIONS OF THE CANADIAN DEPARTMENT OF COMMUNICATIONS.

LE PRÉSENT APPAREIL NUMÉRIQUE N'ÉMET PAS DE BRUITS RADIOÉLECTRIQUES DÉPASSANT LES LIMITES APPLICABLES AUX APPAREILS NUMÉRIQUES DE CLASSE A PRESCRITES DANS LE RÈGLEMENT SUR LE BROUILLAGE RADIOÉLECTRIQUE ÉDICTÉ PAR LE MINISTÈRE DES COMMUNICATIONS DU CANADA.

1. The details of this User's Manual are subject to change even without previous notification.
2. This User's Manual has been prepared with the utmost care to cover all aspects of the time clock's use.
3. Be sure to use your time clock after you have fully understood the hardware and software specifications and limits.
4. No part of this publication may be reproduced, stored in a retrieval system, or transmitted, in any form or by any means, mechanical, photocopying, recording or otherwise.

This User's Manual and its contents are copyrighted by
LATHEM TIME CORP. with all rights reserved.



Lathem Time Corporation

www.lathem.com

(800) 241-4990

Thank you for purchasing our time clock.

For safe and proper operation, please carefully read the manual before using the time clock and save it for reference.

FEATURES:

Main applications : Payroll/job cost recorder, time stamp or numbering machine.

- Quartz time clock
 - Dot matrix printer
 - Perpetual calendar
 - Automatic daylight saving time
 - 4-way print activation
 - Automatic
 - Manual
 - Semi-automatic
 - Combination
 - Adjustable print position
 - Prints in 8 languages
 - Prints numbers/date
- Alphanumeric printing
 - Selectable 4-digit year imprint
 - 12 or 24-hour format
 - Regular minute, 1/10, 1/100 or 5/100 of an hour
 - Password for program protection
 - Digital LCD display (Date, Hour, Minute, Day of the Week indication)
 - Rigid enclosure, wall or desk top mount
 - Full power reserve (optional)

Caution:

Avoid placing the unit in environments that are:

- humid or dusty.
- exposed to direct sunshine.
- subject to frequent or continuous vibrations.
- outside the temperature range between -5° and 45°C ($+25^{\circ}$ and 113°F)
- affected by chemicals or ozone.

Place the time clock close to the wall outlet so that it is easily accessible to disconnect.

For questions about the operation of this time clock, or to order supplies and accessories, please contact Lathem Time at (800)241-4990.

BEFORE USING YOUR TIME CLOCK

Package Contents

Unpack the time clock and check its contents to ensure that the time clock unit and all accessories as shown below are included.

ATTACHED ACCESSORIES

• Time clock

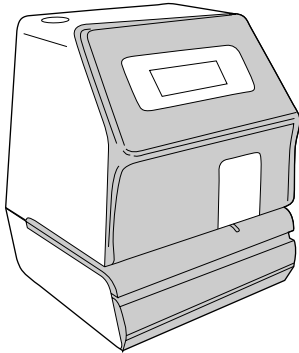

• Ribbon cassette

.....1 ps.

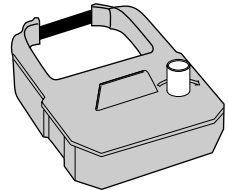

• The ribbon cassette is installed at the factory.

• Keys2 pcs.

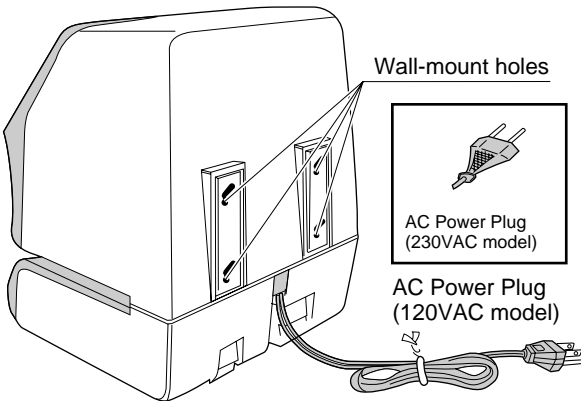
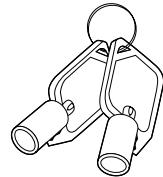

Wall-mount holes

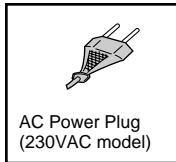

AC Power Plug
(230VAC model)

AC Power Plug
(120VAC model)

• Wall-mount fittings

Screw4 pcs.

Template1 sheet.

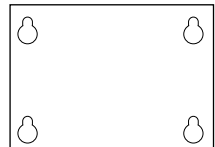

CONFIGURATION

LOCATION OF NAME

It is important to become familiar with the time clock before setting it up and using it.

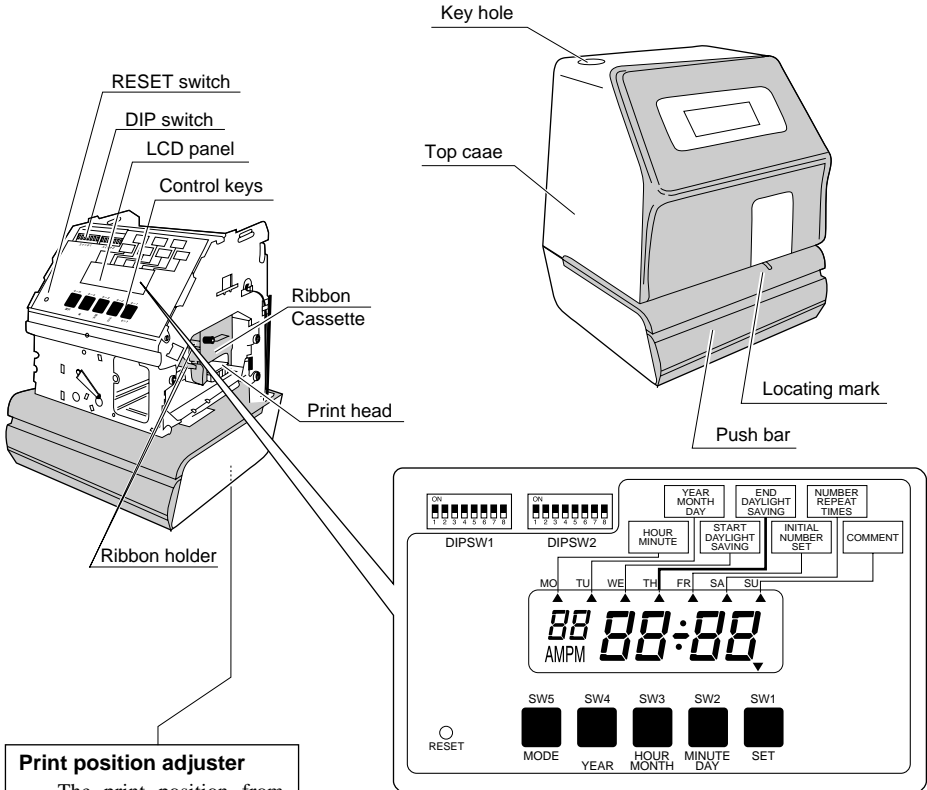

Print position adjuster

The print position from the card edge is adjustable by pressing and sliding the print position button on outside bottom.

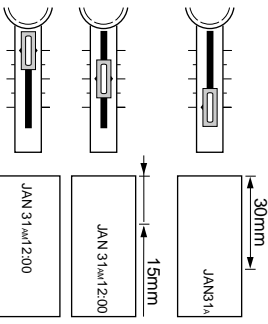

PRINT POSITION ON TIME CARD

The print position from the card edge is adjustable by pressing and sliding the print position button located on the right outside bottom of the recorder. Maxuim distance from edge of form to print is approximately $1 \frac{3}{16}$ " (30mm).

QUICK EASY SETUP

Step 1

Unlock the key and remove the top case.

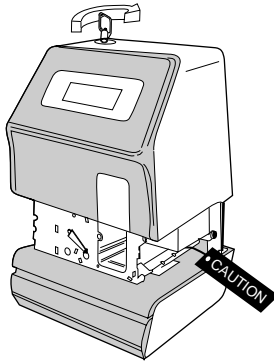

Step 3

Plug the AC cord into the AC outlet. When plugged in the LCD panel indicates the current time. It is now ready to be adjusted if necessary.

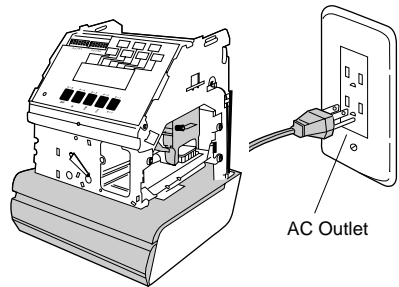

Step 2

Remove the PROTECTION PAD.

 Remove the PROTECTION PAD before you plug the AC cord into the AC outlet.

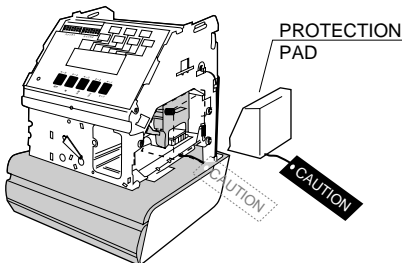

Step 4

Insert a card.

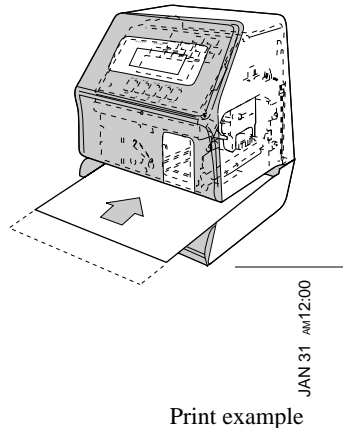

PLEASE NOTE: If a time card is inserted and removed too quickly, the print head will move, but no imprinting will occur. This feature is designed to protect and maintain the life of your printer. Please hold the time card in the recorder until the print head movement is complete.

HOW TO PROGRAM THE CLOCK

To enter the program setting mode, you should plug the AC power cord into the AC outlet and remove the cover. Thereafter press the 5 tactile switches, SW5 to SW1.

< > indicates pressing a tactile switch. Pressing longer will realize faster increments.

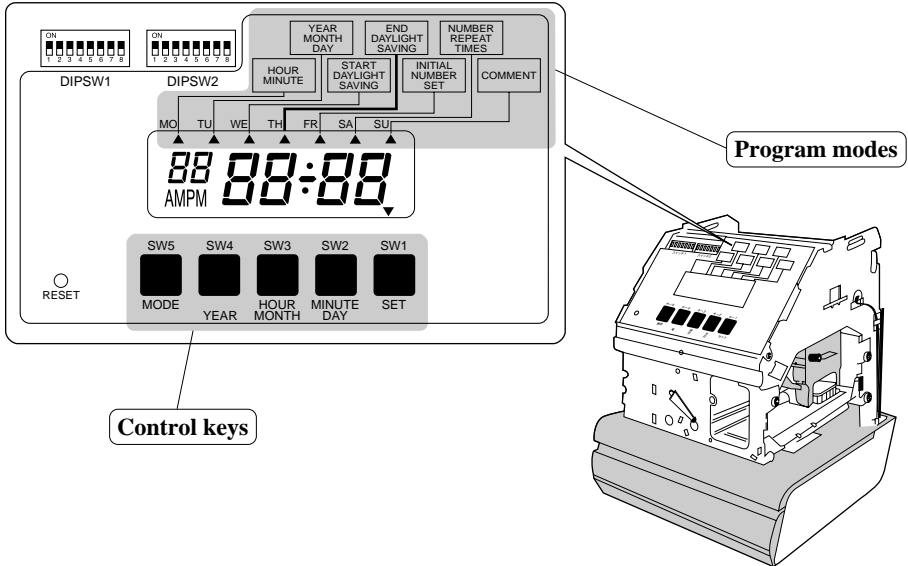

Function of 5 control keys

SW5 : You can select the desired program setting mode by pressing this **SW5** key. Selected program setting mode is indicated by the "▲" mark on the display.

SW4 , **SW3** , **SW2** : When you press the **SW4** , **SW3** and **SW2** keys, you can increment the set value.

SW1 : You can set the value selected on the display by pressing the **SW1** key. Thereafter you press this **SW1** key again, you can return the clock to the normal operation mode.

SETTING THE TIME

Step 1

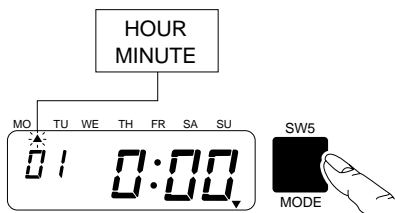

Press the [SW5 : MODE] key once, the "HOUR MINUTE" arrow flashes.

Step 2

Example :

Set to Morning 10:08 AM



Press the [SW3 : HOUR / MONTH] key until the correct hour appears.
The seconds are automatically reset to 00.
Keeping the SW3 pressed, advances the hour automatically.

Step 3



Press the [SW2: MINUTE / DAY] key until the correct minute appears.
Keeping the SW2 pressed, advances the minute automatically. Longer pressing speeds advancement.

Step 4



Press the [SW1: SET] key after checking the desired time appears on the LCD.
The seconds are 00.
Press [SET] accordingly to a time signal.
The unit is now set to correct time.

Step 5



Press the [SW1:SET] key again.

SETTING THE DATE

Step 1

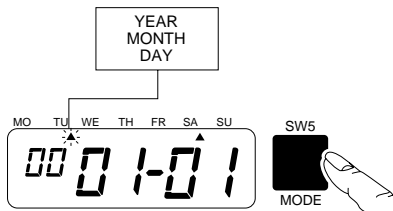

Press the [SW5 : MODE] key twice, the "YEAR / MONTH / DAY" arrow flashes.

Step 2

Example : set to 21st Octobr, 2001

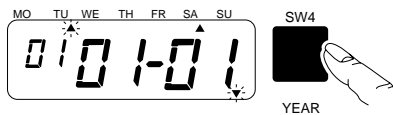

Press the [SW4 : YEAR] key until the correct year appears.

Keeping the SW4 pressed, advances the year automatically. Longer pressing speeds advancement.

Step 3



Press the [SW3 : HOUR / MONTH] key until the correct month appears.

Step 4

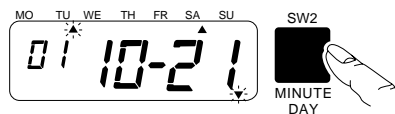

Press the [SW2: MINUTE / DAY] key until the correct day appears. Keeping the SW2 pressed, advances the day automatically. Longer pressing speeds advancement.

Step 5

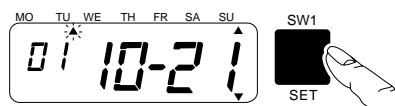

Press the [SW1: SET] key after checking the desired year, month and day on the LCD.

Step 6



Press the [SW1:SET] key again.

SETTING THE STARTING DAYLIGHT SAVING TIME

When the daylight saving time is set, one hour will be automatically added to the day advance time on the starting date and, similarly, one hour will be automatically subtracted on the ending date of the daylight saving time.

Step 1

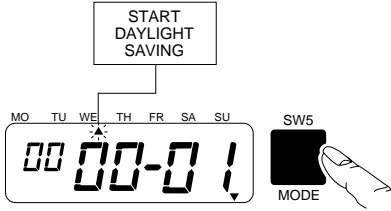

Press the [SW5:MODE] key three times, the "START DAYLIGHT SAVING" arrow flashes.

Example :

Starting from Second of April, 2001

Step 2



Press the [SW4:YEAR] key until the correct year appears.

Keeping the SW4 pressed, advances the year automatically, Longer pressing speeds advancement.

Step 3



Press the [SW3 : HOUR / MONTH] key until the correct month appears.

Step 4



Press the [SW2:MINUTE / DAY] key until the correct day appears.

Keeping the SW2 pressed, advances the day automatically. Longer pressing speeds advancement.

Step 5



Press the [SW1:SET] key after checking the desired year, month and day on the LCD.

Step 6



Press the [SW1: SET] key again.

⚠ If you do not use the daylight saving time function, set the month value to 00.

SETTING THE ENDING DAYLIGHT SAVING TIME

Step 1

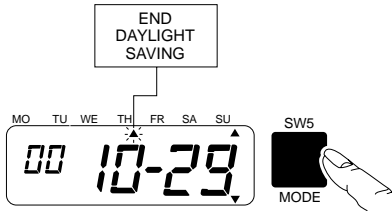

Press the [SW5: MODE] key four times, the "END DAYLIGHT SAVING" arrow flashes.

Example:

End on 28th of October, 2001

Step 2



Press the [SW4: YEAR] key until the correct year appears.
Keeping the SW4 pressed, advances the year automatically. Longer pressing speeds advancement.

Step 3



Press the [SW3 : HOUR / MONTH] key until the correct month appears.

Step 4



Press the [SW2: MINUTE / DAY] key until the correct day appears.
Keeping the SW2 pressed, advances the day automatically. Longer pressing speeds advancement.

Step 5



Press the [SW1: SET] key after checking the desired year, month and day on the LCD.

Step 6



Press the [SW1:SET] key again.

SETTING THE NUMBER

INITIAL NUMBER SET

Step 1

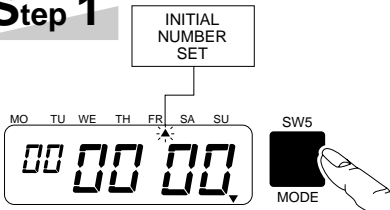

Press the [SW5: MODE] key five times, the "INITIAL NUMBER SET" arrow flashes.

Example:

Setting initial number to 675829.

Step 2

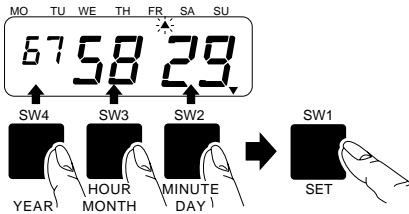

Press the SW2, 3 or 4 key until the correct number appears.

Longer pressing speeds advancement.

Press the [SW1: SET] key after checking the desired number on the LCD.

Step 3



Press the [SW1: SET] key again.

NUMBER REPEAT TIMES SET

Step 1

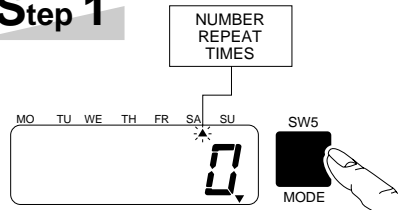

Press the [SW5: MODE] key six times, the "NUMBER REPEAT TIMES" arrow flashes.

Example:

Setting 2 times repeat.

The repeat times can be set to 0 to 9.

Step 2

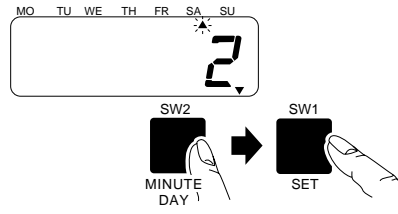

Press the [SW2: MINUTE/DAY] key until the correct number appears.

The repeat times can be selected 0 to 9.

Press the [SW1: SET] key after checking the desired number on the LCD.

Step 3



Press the [SW1: SET] key again.

NUMBER RESET

At the time of changing the date, the number is automatically reset to "0".

Step 1

Plug the AC cord out from the AC outlet.
Confirm the LCD disappeared.
If optional Ni-Cd battery is used, it should be taken off.

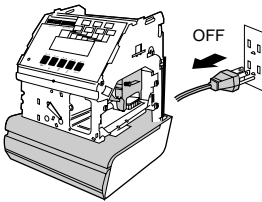

Step 3

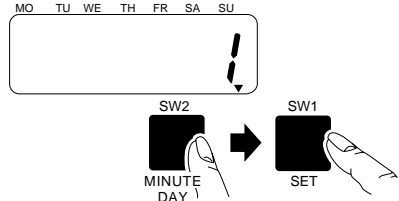

Press the [SW2: MINUTE/DAY] key until the correct number on the LCD.

Press the [SW1: SET] key after checking the desired number on the LCD.

Step 2

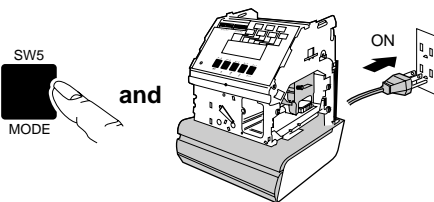

Plug the AC cord into the AC outlet while pressing the [SW5: MODE] key. Then "0" is mentioned on the LCD.

Step 4



Press the [SW1: SET] key again.

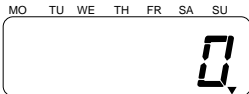

Display	Number reset
0	N / A
!	YES

PREPROGRAMMED COMMENTS SETTING

Step 1

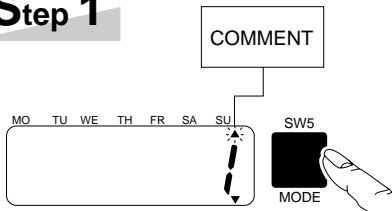

Press the [SW5: MODE] key seven times, the "COMMENT" arrow flashes.

Example:

Setting the comment to SENT.

Step 3



Press the [SW1: SET] key again.

Step 2

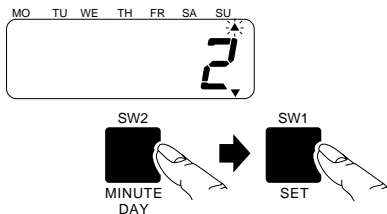

Press the SW2 key until the correct number appears.

No.	1	2	3	4	5	6	7
Comment	RCVD	SENT	IN	OUT	CMFD	FILED	PAID

- The comment will change according to country selection by DIP switch 2-6, 7 and 8.

Press the [SW1:SET] key after checking the desired number on the LCD.

SETTING THE PASSWORD

When the password is set, you are asked to enter it. If the password you entered does not coincide with the setting, you can not change the setting values.

You may set a password by any 4-digit number from 0001 to 9998.

Note a number "00 00" and "99 99" can not be used as a password.

REGISTERING THE PASSWORD

Step 1

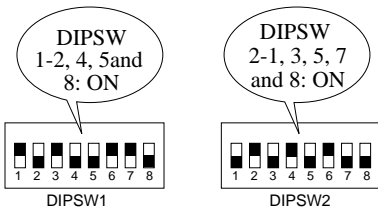

Set DIPSW 1-2, 4, 5, 8 and DIPSW 2-1, 3, 5, 7, 8 to ON. Then display shows "00 00".



Step 2

Example: Password "2878"



Press the [SW3: HOUR/MONTH] key and assign the desired numbers to first two digits.

Step 3



Press the [SW2: MINUTE/DAY] key and assign the desired numbers to the last two digits.

Step 4

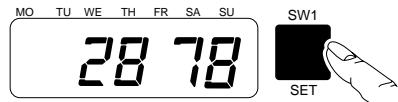

Press the [SW1: SET] key. "▼" located right-below on the LCD will disappear that confirms password setting.

Step 5

Set DIP SW1, and 2 as desired position.



HOW TO CHANGE SETTINGS WHEN PASSWORD IS SET

Once password is set, you have to enter the password for changing any settings. "99 99" will be displayed when you press the [SW5: MODE] key before entering password.

Step 1



Press the [SW5: MODE] key.

Step 3

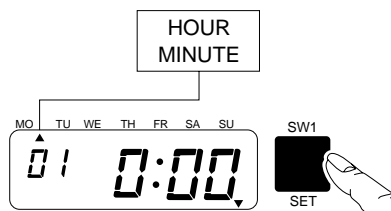

Press the [SW1: SET] key.

Step 2

Example: Password "2878"

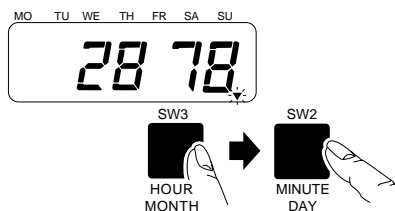

Press the [SW3: HOUR/MONTH], [SW2: MINUTE/DAY] key until the correct number appears.

Step 4

Select desired setting mode by pressing the [SW5: MODE] key. Then make settings as explained.

CANCELING THE PASSWORD

The code "00 00" must be entered to cancel the password.

Step 1

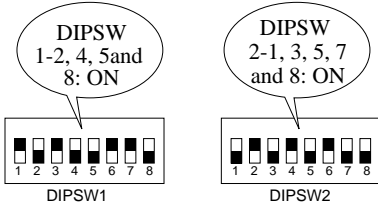

Set DIPSW 1-2, 4, 5, 8, and DIPSW 2-1, 3, 5, 7, 8, to ON. Then display shows "99 99".



Step 2

Example: Cancel Password "2878"

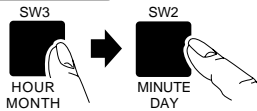

Press the [SW3: HOUR/MONTH], [SW2: MINUTE/DAY] key until the correct number appears.

Step 3



Press the [SW1: SET] key.

Step 4

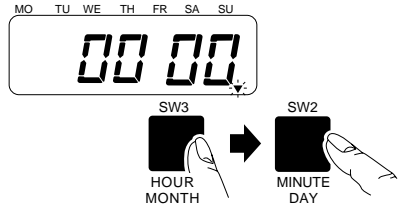

Press the [SW3: HOUR/MONTH], [SW2: MINUTE/DAY] key until "00 00" number appears.

Step 5



Press the [SW1: SET] key. "▼" located right-below on the LCD will disappear that confirms password cancelation.

Step 6

Set DIPSW 1 and 2 as desired position.



PRINT METHOD SETTING

LEFT OR RIGHT PRINT

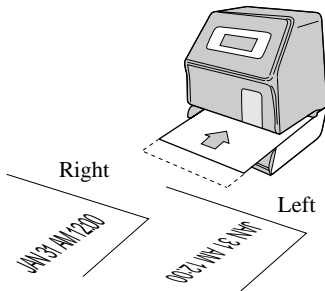

DIP switch 1-7:ON DIP switch 1-7:OFF

The DIPSW1-7 is used to select whether to print flush right or flush left on the card.

PRINT SWITCH

Automatic print

DIPSW1-8:OFF
DIPSW2-1:OFF

Inserting the card automatically initiates printing.

Semi-automatic print

DIPSW1-8:OFF
DIPSW2-1:ON

Only with the card inserted, pressing the push bar starts printing.

Manual print

DIPSW1-8:ON
DIPSW2-1:OFF

Even with no card, pressing the push bar starts printing.

Combination

DIPSW1-8:ON
DIPSW2-1:ON

Either inserting the card or pressing the push bar starts printing.

TYPE OF AN HOUR



JUN 13 18:08

DIP switch 2-5:ON



JUN 13 PM6:08

DIP switch 2-5:OFF

Time can be displayed on a 12-hour (AM, PM) or 24-hour basis. DIP switch 2-5 is used for selection.

Print also changed accordingly.

LEADING 0

Leading 0 for hours less than 10 may be shown (enable) or suppressed (disable) on print.

DIP switch 2-4:ON



JUN 13 AM08:08

Print Example

DIP switch 2-4:OFF



JUN 13 AM8:08

TYPE OF MINUTES

Minute is printed in a unit which is obtained by dividing an hour by 60, 100, 20 or 10.

DIP switches 2-2 and 2-3 are used for selection.

Print contents	Print Example
To divide an hour by 60 : 0,1,2...58,59,0,1,2....	JAN 1 AM12:40
To divide an hour by 100 : 0,1,2...98,99,0,1,2....	JAN 1 AM12.67
To divide an hour by 20 : 0,5,10...90,95,0,5,10...	JAN 1 AM12.65
To divide an hour by 10 : 0,1,2...8,9,0,1,2....	JAN 1 AM12.6

NUMBER OF YEAR DIGITS

Year can be printed either 2 digits or 4 digits. DIPSW 1-6 is used for the selection.

DIPSW1-6: OFF

'01 OCT 21 AM10:08

DIPSW1-6: ON

2001 OCT 21 AM10:08

TYPE OF LANGUAGE

You can choose 8 different languages for printing month, day of the week, and preprogrammed comments. Use DIPSW 2-5 ~ 2-8 for setting.

Language	Example
English	DEC 21 AM10:08
Spanish	DIC 21 AM10:08
German	DEZ 21 AM10:08
French	DEC 21 AM10:08
Italian	DEC 21 AM10:08
Portuguese	DEZ 21 AM10:08
Roman	XII 21 AM10:08
Numeric	12-21 AM10:08

WALL MOUNTING

Step 1

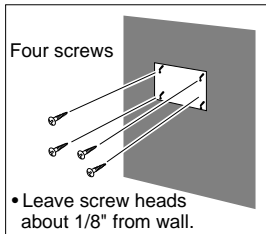

Step 2

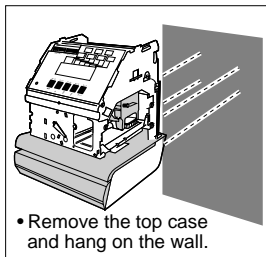

Step 3

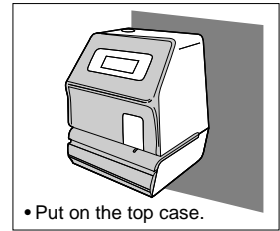

- ⚠ • Select wall area near AC outlet.
- Mount the Time Recorder on wood or a surface which can support weight (dry wall will not support unit).

REPLACING RIBBON CASSETTE

1. Carefully slide the exposed ribbon under the print head.
2. Push cassette with the projection into the ribbon cassette holder until snapped into place.
3. Turn the ribbon feed knob clockwise until the ribbon is taut.

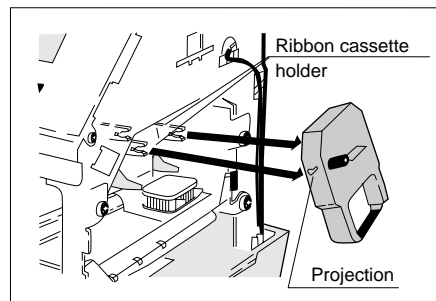

DIP SWITCH SETTING

DIPSW1		DIPSW2		Print example	Meaning
ON		ON			
○ ○ ○ ○ ○ ○ ○ ○	○ ○ ○ ○ ○ ○ ○ ○	JAN 31 AM12:00	Mon, Day, Hour, Min		
● ○ ○ ○ ○ ○ ○ ○	○ ○ ○ ○ ○ ○ ○ ○	31 JAN AM12:00	Day, Mon, Hour, Min		
○ ● ○ ○ ○ ○ ○ ○	○ ○ ○ ○ ○ ○ ○ ○	JAN 31 '00 AM12:00	Mon, Day, Year, Hour, Min		
● ● ○ ○ ○ ○ ○ ○	○ ○ ○ ○ ○ ○ ○ ○	31 JAN '00 AM12:00	Day, Mon, Year, Hour, Min		
○ ○ ● ○ ○ ○ ○ ○	○ ○ ○ ○ ○ ○ ○ ○	'00 JAN 31 AM12:00	Year, Mon, Day, Hour, Min		
● ● ○ ○ ○ ○ ○ ○	○ ○ ○ ○ ○ ○ ○ ○	'00 JAN 31 AM12:00:00	Year, Mon, Day, Hour, Min, Sec		
○ ● ● ○ ○ ○ ○ ○	○ ○ ○ ○ ○ ○ ○ ○	'00 JAN 31	Year, Mon, Day		
● ● ● ○ ○ ○ ○ ○	○ ○ ○ ○ ○ ○ ○ ○	JAN 31	Mon, Day		
○ ○ ○ ● ○ ○ ○ ○	○ ○ ○ ○ ○ ○ ○ ○	31 AM12:00	Day, Hour, Min		
● ○ ○ ● ○ ○ ○ ○	○ ○ ○ ○ ○ ○ ○ ○	MO, 31 AM12:00	DOW, Day, Hour, Min		
○ ● ○ ● ○ ○ ○ ○	○ ○ ○ ○ ○ ○ ○ ○	MO, 31 JAN '00	DOW, Day, Mon, Year		
● ● ● ○ ○ ○ ○ ○	○ ○ ○ ○ ○ ○ ○ ○	000000 JAN 31 '00	Num, Mon, Day, Year		
○ ○ ● ● ○ ○ ○ ○	○ ○ ○ ○ ○ ○ ○ ○	000000 31 JAN '00	Num, Day, Mon, Year		
● ○ ● ● ○ ○ ○ ○	○ ○ ○ ○ ○ ○ ○ ○	000000 '00 JAN 31	Num, Year, Mon, Day		
○ ● ● ● ○ ○ ○ ○	○ ○ ○ ○ ○ ○ ○ ○	JAN 31 '00 000000	Mon, Day, Year, Num		
● ● ● ● ○ ○ ○ ○	○ ○ ○ ○ ○ ○ ○ ○	31 JAN '00 000000	Day, Mon, Year, Num		
● ○ ○ ○ ● ○ ○ ○	○ ○ ○ ○ ○ ○ ○ ○	'00 JAN 31 000000	Year, Mon, Day, Num		
○ ● ○ ○ ● ○ ○ ○	○ ○ ○ ○ ○ ○ ○ ○	000000 31 AM12:00	Num, Day, Hour, Min		
● ● ○ ○ ● ○ ○ ○	○ ○ ○ ○ ○ ○ ○ ○	000 JAN 31 AM12:00	Num, Mon, Day, Hour, Min		
○ ○ ● ○ ● ○ ○ ○	○ ○ ○ ○ ○ ○ ○ ○	0000 '00 JAN 31 AM12:00	Num, Year, Mon, Day, Hour, Min		
● ○ ● ○ ● ○ ○ ○	○ ○ ○ ○ ○ ○ ○ ○	00000 '00 JAN 31 0:00	Num, Year, Mon, Day, Hour, Min		
○ ● ● ● ● ○ ○ ○	○ ○ ○ ○ ○ ○ ○ ○	000000	Num		
● ● ● ● ● ○ ○ ○	○ ○ ○ ○ ○ ○ ○ ○	RCVD JAN 31 '00	Com, Mon, Day, Year		
○ ○ ○ ● ● ○ ○ ○	○ ○ ○ ○ ○ ○ ○ ○	RCVD 31 JAN '00	Com, Day, Mon, Year		
● ○ ○ ○ ● ● ○ ○ ○	○ ○ ○ ○ ○ ○ ○ ○	RCVD '00 JAN 31	Com, Year, Mon, Day		
● ● ○ ○ ● ● ○ ○ ○	○ ○ ○ ○ ○ ○ ○ ○	JAN 31 '00 RCVD	Mon, Day, Year, Com		
○ ○ ● ● ● ○ ○ ○	○ ○ ○ ○ ○ ○ ○ ○	31 JAN '00 RCVD	Day, Mon, Year, Com		
● ○ ● ● ● ○ ○ ○	○ ○ ○ ○ ○ ○ ○ ○	'00 JAN 31 RCVD	Year, Mon, Day, Com		
○ ● ● ● ● ○ ○ ○	○ ○ ○ ○ ○ ○ ○ ○	RCVD 31 AM12:00	Com, Day, Hour, Min		
● ● ● ● ● ○ ○ ○	○ ○ ○ ○ ○ ○ ○ ○	ABC HOTEL	Customized Comments		

○ : OFF ● : ON

DIPSW1		DIPSW2		Print example	Meaning													
ON		ON																
1	2	3	4	5	6	7	8	1	2	3	4	5	6	7	8			
○	○	○	○	○	○	○	○	○	○	○	○	○	○	○	○	'00 JAN 31 AM12:00	Types of Year (2 digits)	①
○	○	○	○	●	○	○	○	○	○	○	○	○	○	○	○	2000 JAN 31 AM12:00	Types of Year (4 digits)	
○	○	○	○	○	○	○	○	○	○	○	○	○	○	○	○	JAN 31 AM12:00	Flush Left Print	②
○	○	○	○	○	○	○	○	○	○	○	○	○	○	○	○	00:Z1M4 1E N47	Flush Right Print	
○	○	○	○	○	○	○	○	○	○	○	○	○	○	○	○		Automatic	③
○	○	○	○	○	○	○	○	○	○	○	○	○	○	○	○		Manual	
○	○	○	○	○	○	○	○	○	○	○	○	○	○	○	○		Combination	
○	○	○	○	○	○	○	○	○	○	○	○	○	○	○	○		Semi-automatic	
○	○	○	○	○	○	○	○	○	○	○	○	○	○	○	○	JAN 31 AM12:40	60 Min/Hour	④
○	○	○	○	○	○	○	○	○	○	○	○	○	○	○	○	JAN 31 AM12.67	100 Min/Hour	
○	○	○	○	○	○	○	○	○	○	○	○	○	○	○	○	JAN 31 AM12.65	20 Min/Hour	
○	○	○	○	○	○	○	○	○	○	○	○	○	○	○	○	JAN 31 AM12.6	10 Min/Hour	
○	○	○	○	○	○	○	○	○	○	○	○	○	○	○	○	JAN 1 PM3:00	Zero Disabled	⑤
○	○	○	○	○	○	○	○	○	○	○	○	○	○	○	○	JAN 01 PM03:00	Zero Enabled	
○	○	○	○	○	○	○	○	○	○	○	○	○	○	○	○	JAN 31 PM3:00	AM/PM	⑥
○	○	○	○	○	○	○	○	○	○	○	○	○	○	○	○	JAN 31 15:00	24 Hours	
○	○	○	○	○	○	○	○	○	○	○	○	○	○	○	○	JAN 31 AM12:00	English	⑦
○	○	○	○	○	○	○	○	○	○	○	○	○	○	○	○	ENE 31 AM12:00	Spanish	
○	○	○	○	○	○	○	○	○	○	○	○	○	○	○	○	JAN 31 AM12:00	German	
○	○	○	○	○	○	○	○	○	○	○	○	○	○	○	○	JAN 31 AM12:00	French	
○	○	○	○	○	○	○	○	○	○	○	○	○	○	○	○	GEN 31 AM12:00	Italian	
○	○	○	○	○	○	○	○	○	○	○	○	○	○	○	○	JAN 31 AM12:00	Portuguese	
○	○	○	○	○	○	○	○	○	○	○	○	○	○	○	○	I31 AM12:00	Roman	
○	○	○	○	○	○	○	○	○	○	○	○	○	○	○	○	1-31 AM12:00	Numeric	
○	○	○	○	○	○	○	○	○	○	○	○	○	○	○	○		Password	

○ : OFF ● : ON

- ① NUMBER OF YEAR DIGITS
- ② LEFT OR RIGHT PRINT
- ③ PRINT SWITCH
- ④ TYPE OF MINUTES
- ⑤ LEADING 0
- ⑥ TYPE OF AN HOUR
- ⑦ TYPE OF LANGUAGE

SPECIFICATIONS

MAIN FUNCTION

Calendar	Year up to 2099 (Automatically adjusted to leap year)
Clock accuracy	Monthly accuracy ± 15 seconds (at ordinary temperatures)
Display	Digital LCD with 7 segments Date, Hour, Minute and day of the week indication
Daylight saving time	Auto
Preprogramed comments	Selectable 7 different kinds
Customized comments	Available up to 3 lines
DIP switch	16 poles
Memory Backup	3 year memory backup by lithium battery.

PRINT FUNCTION

Print method	Impact Dot Matrix - 9pins 4-way Card activated automatic, manual, semi- automatic or combination
Print position/ direction	Adjustable trigger trip Right/Left print by DIP switch
Hour & minute format	12 or 24-hours format, regular minute, 1/10, 1/100 or 5/100 of a hour
Multiple copies	Original + 4 (Maximum thickness 3mm or less)
Ribbon cassette	Carry-on cassette type fabric ink ribbon

OTHER SPECIFICATIONS

Power supply	110 VAC, 120 VAC 230 VAC, 220-240 VAC
Power consumption	
110/120VAC	20 VA max.while printing 4 VA while idling 0.2 A max.while printing
220-240/230VAC	20 VA max.while printing 4 VA while idling 0.1 A max.while printing
Temperature	Operating -5°C – 45°C
Humidity	Operating 20% – 80% RH (No condensation)
Dimensions	6 27/32" x 6 3/16" x 8 3/16" (174mm(W) x157mm(D) x208mm(H))
Weight	Approximately 5.5lb.(2.5 Kg)

OPTION

Ribbon cassette	VIS6002
Battery	VIS6001 (Available of 200 prints or 72 hours during no electricity.)

In case of power failure

Even if a power failure has occurred, the optional built-in battery backs up to 72 hours (roughly three days), provided that the battery cells are fully charged.

No printing battery capacity

The display is flashing when detecting the low battery capacity. Please stop printing until AC power supply is resumed.

If you still keep printing, the time recorder will hang up. When hung up, you have to press the RESET switch on the control panel by using a pair of tweezers. In this case, the calendar clock is cleared.

Bescheinigung des Herstellers/Importeurs

Dies Gerät entspricht den Bedingungen der Niederspannungs-Vorschrift 73/23/EEC und dem EMVG nach 89/336/EEC.

This unit complies with the Low Voltage Directive 73/23/EEC and the EMC Directive 89/336/EEC.

Maschinenlärminformationsverordnung 3. GSGV,18.01.1991:Der arbeitsplatzbezogene Schalldruckpegel beträgt 70 dB(A) oder weniger gemäß ISO 7779.

Die zugehörige Steckdose muß nahe beim Gerät angebracht und leicht zugänglich sein.

Free Manuals Download Website

<http://myh66.com>

<http://usermanuals.us>

<http://www.somanuals.com>

<http://www.4manuals.cc>

<http://www.manual-lib.com>

<http://www.404manual.com>

<http://www.luxmanual.com>

<http://aubethermostatmanual.com>

Golf course search by state

<http://golfingnear.com>

Email search by domain

<http://emailbydomain.com>

Auto manuals search

<http://auto.somanuals.com>

TV manuals search

<http://tv.somanuals.com>