



LATHEM TIME

Digital Display Wall Clock

DDC2 / DDC4 Series

Installation & User's Guide

OMNI:CHRON, mini:master, Lathem and the Lathem logo are registered trademarks of Lathem Time Corporation. Other product names mentioned in this manual may be trademarks of their respective companies and are hereby acknowledged.

WARNING: Changes or modifications to this product not expressly approved by the party responsible for compliance could void the user's authority to operate this equipment.

This device complies with Part 15 of the FCC Rules. Operation is subject to the following two conditions: (1) this device may not cause harmful interference, and (2) this device must accept any interference received, including interference that may cause undesired operation.

NOTICE: This equipment has been tested and found to comply with the limits for a Class B digital device, pursuant to Part 15 of the FCC Rules. These limits are designed to provide reasonable protection against harmful interference in a residential installation. This equipment generates, uses, and can radiate radio frequency energy and, if not installed and used in accordance with the instructions, may cause harmful interference to radio communications. However, there is no guarantee that interference will not occur in a particular installation. If this equipment does cause harmful interference to radio or television reception, which can be determined by turning the equipment off and on, the user is encouraged to try to correct the interference by one or more of the following measures:

- Reorient or relocate the receiving antenna.
- Increase the separation between the equipment and receiver.
- Connect the equipment into an outlet on a circuit different from that to which the receiver is connected.
- Consult the dealer or an experienced radio TV technician for help.

**This Class B digital apparatus complies with Canadian ICES-003.
Cet appareil numérique de la classe B est conforme à la norme NMB-003 du Canada.**

Copyright © 2001 Lathem Time Corporation. All rights reserved.

Lathem Time Corporation
200 Selig Drive, SW
Atlanta, GA 30336
www.lathem.com

Document Number: USG0028E
Revised 05-28-2008

Table of Contents

Introduction.....	1
Clock Operation.....	1
About this Manual	2
Optional Accessories	3
Configuring the DDC Series Wall Clock.....	4
Setting the DIP Switches - DDC2 / DDC4 Series.....	5
DDC2	5
DDC4	5
DIP Switch Settings	6
Configuring RS485 Communications - DDC2/4-RS Series	7
DDC2-RS.....	7
DDC4-RS.....	7
Battery Usage - DDC2 / DDC4 Series.....	7
DDC2/4-RS / DDC2/4-RS-24.....	7
Battery Installation - DDC2 / DDC4 Series	8
DDC2	8
DDC4	8
Power Cord Installation - DDC2/4-RS	8
DDC2-RS.....	8
DDC4-RS.....	9
Wiring Installation - DDC2/4-RS Series.....	9
Secondary Wiring	9
RS485 Wiring	9
DDC-TC Wiring	9
Replacing an Existing DDC4 Wall Clock.....	10
Board Layout Diagram	10
Mounting - DDC2 / DDC4 Series.....	11
Mounting to a Wall	11
DDC2	11
DDC4	12
Mounting to a Single Gang Box	12
DDC2	13
DDC4	13
Double Mount - Wall.....	14
DDC2 (Double Mount - Wall).....	15
DDC4 (Double Mount - Wall).....	16
Double Mount - Ceiling	16
Double Mount - Ceiling	17

DDC4 (Double Mount - Ceiling)	19
Setting the Time	20
Time Formats	20
12 Hour Format	20
24 Hour Format	20
Appendix A - DDC2-RS / 4-RS Secondary Clock Wiring Diagrams	21
Stand-Alone (115VAC)	21
3-Wire Synchronous (115VAC)	22
3-Wire Synchronous (24VAC)	23
3-Wire minute Impulse (59 th Minute)	24
3-Wire Minute Impulse (59 th Minute With 12 Hour Correction)	25
Standard Electric Synchronous	26
Standard Electric AR-2A 2-Wire Dual Voltage	27
Standard Electric AR-2 2-Wire Dual Voltage	28
Synchronous Wired	29
Simplex 59 th Minute Dual Motor	30
Simplex 45 th Minute Dual Motor	31
Edwards Dual Motor	32
Standard Electric AR-3 3-Wire Minute Impulse	33
National Synchronous Wired	34
Stromberg Synchronous Wired (56 th Minute)	35
Cincinnati D1	36
Cincinnati D6, Edwards 2406	37
2-Wire Pulse Alternating (24VDC)	38
Electronic Coded	39
Straight Frequency	40
3-Wire Minute Impulse (58 th Minute)	41
3-Wire Minute Impulse (44 th Minute)	42
2-Wire Reverse Polarity Minute Impulse (59 th Minute)	43
Appendix B - DDC2-RS-24 / DDC4-RS-24 Wiring	44
DDC2-RS-24 / DDC4-RS-24 Wiring	45
Appendix C - RS485 Wiring Diagrams	46
RS485 Data Format	46
OMCII to DDC2-RS / 4-RS	47
LTR0 to DDC2-RS / 4-RS	48
LTR4 / 8-512 to DDC2-RS / 4-RS	49
Appendix D - DDC-TC Timer Control Panel	50
Wiring	50
Installation	51
Operation	52

As a Count Up Timer	52
As a Count Down Timer	52
Appendix E - LTR-GPS Satellite Receiver / Clock Synchronizer.....	53
Connecting to a Lathem DDC2-RS or DDC4-RS Digital Clock	55
Appendix F - Specifications.....	56
Appendix G - Warranty	57

Introduction

The Digital Display Series Wall Clocks are designed with 2-inch or 4-inch red LED displays that can be viewed from great distances; the 4-inch model as far away as 100 feet, the 2-inch model from as far away as 50 feet. The bright red display shows the hour and minutes and can be configured for a 12 or 24 hour format. By the setting of internal DIP switches, the DDC Series Wall Clocks can be configured to run as "stand-alone" or to replace many analog secondary clocks that may be hard to find or no longer available.

The DDC Series Wall Clocks can be synchronized from the Lathem LTR4-512 or LTR8-512 Master, LTR0 mini:master, Terminal Manager Software or the OMNI:CHRON Time Clock, using an RS485 correction signal.

The DDC Series Wall Clocks with the optional DDC-TC Timer Control Panel allow the DDC Series Wall Clocks to act as a count up or count down timer as well as displaying the normal time. The optional Timer Control Panel is required to use this feature.

The DDC Series Wall Clocks can be mounted directly to a wall, to a single gang outlet box or, with optional mounting kits, as double-faced units from the wall or ceiling.

During power failures, a 9-Volt alkaline battery (not supplied) can maintain the DDC Series Wall Clock's internal time keeping (although the display is blank during power failures).

Clock Operation

When the Digital Display Series Wall Clocks are set to operate as stand-alone or synchronous wired secondary clocks, the time base is derived from the AC power source. The frequency (50Hz or 60Hz) is automatically detected when power is applied. The clocks then initialize to 12:00AM and maintain time by counting the line frequency. Corrective clocks will begin synchronization routines. Accuracy is related directly to the accuracy of the line frequency. With the DDC-TC option, the Digital Display Series Wall Clocks can act as a count up or count down timer as well as running as a stand-alone or synchronous wired secondary clock.

When the Digital Display Series Wall Clocks are set to operate as impulse secondary clocks, the master clock controls time totally. Time will only advance when pulses are received from the master clock. Should the master clock lose power, the wall clocks would hold at the time that the last pulse was received until power to the master clock is restored and pulses continue. With the DDC-TC option, the Digital Display Series Wall Clocks can act as a count up or count down timer as well as running as an impulse secondary clock.

About this Manual

This manual will guide you through the installation, setup and wiring of your DDC Series Wall Clock. This manual covers the four available DDC Series models. The available models and their descriptions are:

DDC2-RS / DDC4-RS Equipped with a 2-inch or 4-inch display, these models can operate as a stand-alone, a secondary clock to virtually any master controlled system or can be synchronized with the RS485 signal from the Lathem LTR4-512 or LTR8-512 Master, LTR0 mini:master, Terminal Manager Software* or the OMNI:CHRON Time Clock.

DDC2-RS-24 / DDC4-RS-24 Same as above, models with the "-24" suffix have an optional power transformer that allows for 24VAC operation. These models are designed to be powered from an external, 24VAC-power supply for use in installations where local 115VAC power may not be available.

* The Lathem SWIFT-485 plus is required for RS485 synchronization.

Optional Accessories

VSE0050	Power Cord, 6 feet. DDC Series Wall Clocks are shipped without power cords.
SAM0626	Double Ceiling Mount Kit for DDC2 or DDC4 Series
SAM0630	Double Wall Mount Kit for DDC2 Series
SAM0625	Double Wall Mount Kit for DDC4 Series
VSE0052	Mounting Bracket for 3510 Hz Electronic Receiver. (DDC4 only, installer must use optional method to mount Receiver outside the DDC2 if Receiver is used) (Receiver not included)
DDC-TC	Timer Control Panel to use the DDC2/4 Series as a count up/down timer
LTR4-512	
LTR8-512	
LTR8-512M	Master Clocks capable of synchronizing the DDC Series Wall Clocks as well as many other brands and types of wall clocks. Available configurations include 8, 6, 4 and 2 bell circuits
Mlink	Master Link software for remote programming of the LTR8-512 and LTR8-512M Master Clocks
SWIFT-485 plus	RS232 to RS485 signal converter for use with Master Link to extend the distance of Master Clocks up to 4000'.

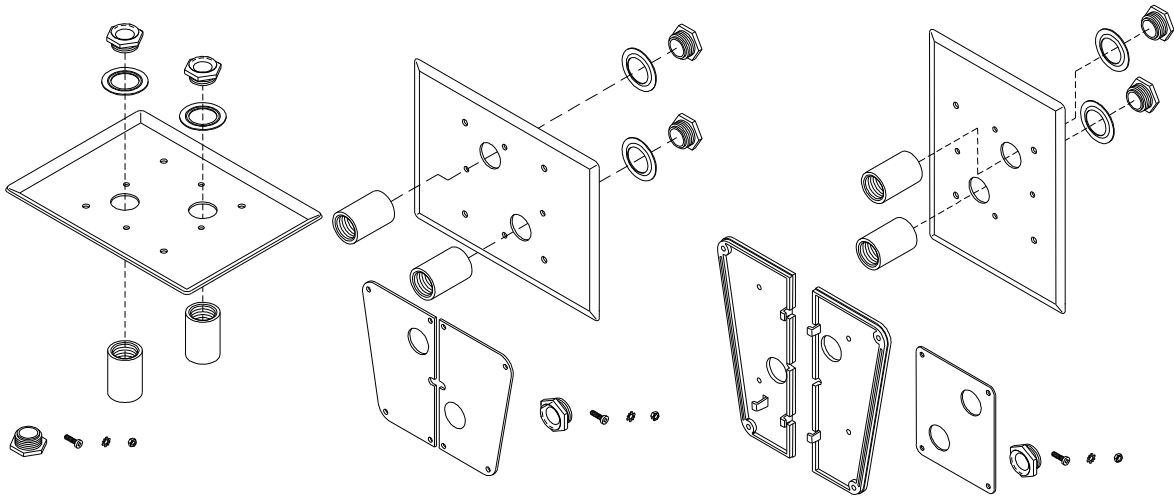

SAM0626 Kit (left) Includes:

1 - Mounting Plate Assembly 2 - Chase Nipples 4 - #10 Screws 8 - #10 Lock Washers
8 - #10 Hex Nuts

SAM0630 Kit (middle) Includes:

1 - Mounting Plate Assembly 2 - Modified End Caps 2 - Chase Nipples 4 - #10 Screws
8 - #10 Lock Washers 4 - #10 Hex Nuts

SAM0625 Kit (right) Includes:

1 - Mounting Plate Assembly 2 - Modified End Caps 1 - End Cap Support 2 - Chase Nipples
4 - #10 Screws 8 - #10 Lock Washers 4 - #10 Hex Nuts 4 - #6 Screws
4 - #6 Lock Washers 4 - #6 Hex Nuts

Configuring the DDC Series Wall Clock

Setting the DIP Switches - DDC2 / DDC4 Series

DDC2

Remove the four phillips head screws from the left or the right end cap and remove. Slide the lens and circuit board assembly out of the case. Place the lens aside and carefully flip the circuit board assembly over and lay it face down on a clean, smooth work surface. Locate switch S1 near the center of the circuit board and set the DIP switches (See figure 1 below) according to Tables 1, 2 and 3 on the following page for the proper configuration. Slide the lens and circuit board assembly back into the case, replace the end cap and secure with the four phillips head screws.

DDC4

Remove the two phillips head screws from the left or the right end cap and remove. Slide the front panel assembly out of the case. Carefully flip the front panel assembly over and lay it face down on a clean, smooth work surface. Locate switch S1 near the center of the circuit board and set the DIP switches (See figure 1 below) according to Tables 1, 2 and 3 on the following page for the proper configuration. Slide the front panel display back into the case, replace the end cap and secure with the two phillips head screws.

Switch S1

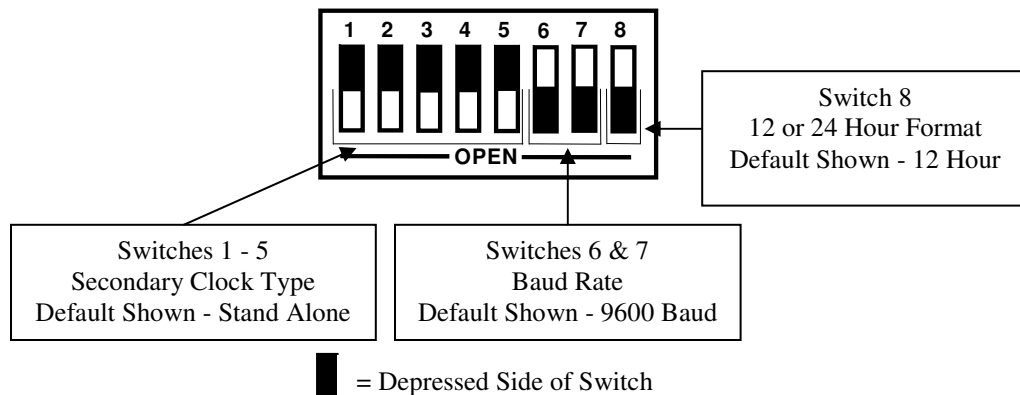

Figure 1

DIP Switch Settings

Table 1 - S1 (1-5) Secondary Clock Correction

1	2	3	4	5	Secondary Clock Selection
					0=Closed 1=Open *=Factory Default
0	0	0	0	0	Stand Alone *
1	0	0	0	0	3-Wire Synchronous
0	1	0	0	0	3-Wire Minute Impulse (59 th Minute)
1	1	0	0	0	3-Wire Minute Impulse (59 th Minute) With 12 Hour Correction
0	0	1	0	0	Standard Electric Synchronous
1	0	1	0	0	Standard Electric AR-2A - 2-Wire Dual Voltage
0	1	1	0	0	Standard Electric AR-2 - 2-Wire Dual Voltage
1	1	1	0	0	Cincinnati D8, Honeywell ST402A, Faraday Synchronous
0	0	0	1	0	Simplex 59 th Minute Dual Motor
1	0	0	1	0	Simplex 45 th Minute Dual Motor
0	1	0	1	0	Edwards Dual Motor
1	1	0	1	0	Standard Electric AR-3 - 3-Wire Minute Impulse
0	0	1	1	0	National Synchronous Wired
1	0	1	1	0	Stromberg Synchronous Wired
0	1	1	1	0	Cincinnati D1
1	0	0	0	1	Cincinnati D6, Edwards 2406
0	1	0	0	1	2-Wire Impulse Alternating (24VDC)
1	1	0	0	1	Electronic Coded (3510 Hz Receiver Required)
0	0	1	0	1	Straight Frequency (3510 Hz Receiver Required)
1	0	1	0	1	3-Wire Minute Impulse (58 th Minute)
0	1	1	0	1	3-Wire Minute Impulse (44 th Minute)
1	1	1	0	1	2-Wire Reverse Polarity Minute Impulse (59 th Minute)

Table 2 - S1 (6-7) RS 485 Baud Rate

6	7	Baud Rate
0=Closed 1=Open		
0	0	1200 Baud
1	0	2400 Baud
0	1	4800 Baud
1	1	9600 Baud *

Table 3 - S1 (8) 12 / 24 Hour Display

8	12 / 24 Hour Display
0=Closed 1=Open	
1	12 Hour *
0	24 Hour

Note: When switches 1-5 are set for any secondary type other than Stand-Alone, the display is forced to 12 Hour and the PM indicator does not illuminate.

Configuring RS485 Communications - DDC2/4-RS Series

When multiple DDC2 (4)-RS Series Wall Clocks are installed as slave units to either the Lathem LTR4-512 or LTR8-512 Master, LTR0 Mini-Master, Terminal Manager Software or the OMNI:CHRON Time Clock, the last clock on the line must have a shunt installed over both pins at position J2 (see figure 2, page 9). When shipped, the shunt is placed over only one pin of position J2 in an "open" setting. It is necessary to place the shunt over both pins of position J2 and create a "closed" setting for the last clock on the line.

DDC2-RS

Remove the four phillips head screws from the left or the right end cap and remove. Slide the lens and circuit board assembly out of the case. Place the lens aside and carefully flip the circuit board assembly over and lay it face down on a clean, smooth work surface. Locate position J2 on the left, upper side of the back of the circuit board assembly (see figure 2, page 9). Lift the shunt straight up off the single pin of position J2. Align the shunt to cover both pins of position J2 and press firmly into place. Slide the lens and circuit board assembly back into the case, replace the end cap, and secure with the four phillips head screws.

DDC4-RS

Remove the two phillips head screws from the left or the right end cap and remove. Slide the front panel assembly out of the case. Carefully flip the front panel assembly over and lay it face down on a clean, smooth work surface. Locate position J2 on the left, upper side of the back of the front panel. (See figure 2, page 9) Lift the shunt straight up off the single pin of position J2. Align the shunt to cover both pins of position J2 and press firmly into place. Slide the front panel display back into the case, replace the end cap and secure with the two phillips head screws.

*Note: Only the **LAST** clock on the line needs position J2 "closed". Leave all other clocks "open".*

Battery Usage - DDC2 / DDC4 Series

Depending on the secondary selection type, the 9-Volt alkaline battery (not included) performs different functions and may be required for proper operation.

DDC2/4-RS / DDC2/4-RS-24

When used as a secondary type clock the 9-Volt alkaline battery (not included) will retain the time that the power failure occurred, although the display will go blank. When power is restored, correction signals from the master clock will advance the wall clock to the proper time. When used as a secondary type clock in systems that do not provide a 12-Hour correction signal, the 9-Volt alkaline battery (not included) is required for proper operation. Without the 9-Volt alkaline battery (not included), the wall clock will reset to 12:00 AM after power resumes and will not receive the proper signal from the master clock to fully correct.

When used as a RS485 clock, the master clock will send a signal to the wall clock every minute. The 9-Volt alkaline battery (not included) is optional in these types of installations.

Battery Installation - DDC2 / DDC4 Series

DDC2

Remove the four phillips head screws from the left or the right end cap and remove. Slide the lens and circuit board assembly out of the case. Place the lens aside and carefully flip the circuit board assembly over and lay it face down on a clean, smooth work surface. Locate the Battery Cradle on the upper right corner of the circuit board assembly. (See figure 2, page 9) Slide the battery into the cradle making sure the Positive and Negative connections of the battery and cradle match. Snap the battery onto the connections located inside the battery cradle. Slide the lens and circuit board assembly back into the case, replace the end cap and secure with the four phillips head screws.

DDC4

Remove the two phillips head screws from the left or the right end cap and remove. Slide the front panel assembly out of the case. Carefully flip the front panel assembly over and lay it face down on a clean, smooth work surface. Locate the Battery Cradle on the upper right corner of the circuit board assembly. (See figure 2, page 9) Slide the battery into the cradle making sure the Positive and Negative connections of the battery and cradle match. Snap the battery onto the connections located inside the battery cradle. Slide the front panel display back into the case, replace the end cap and secure with the two phillips head screws.

Power Cord Installation - DDC2/4-RS

Note: This section refers only to the 115VAC models. Applying power other than 24VAC to models DDC2-RS-24 or DDC4-RS-24 WILL CAUSE DAMAGE and void the warranty. See Appendix B for proper wiring of these models.

DDC2-RS

Remove the four phillips head screws from the left or the right end cap and remove. Slide the lens and circuit board assembly out of the case. Place the lens aside and carefully flip the circuit board assembly over and lay it face down on a clean, smooth work surface. Remove one of the vent caps from the case of the wall clock and route the power cord through it to the back of the circuit board assembly. (If the power cord will be routed through the back-of-the-clock conduit access, route the cord through the gang box and conduit access hole to the back of the circuit board assembly). Strip away 1/2" of the protective shield from each wire of the power cord. Locate the two black wires leading from J1 (see figure 2, page 9) and attach the AC In line of the cord to one and the AC Return line to the other. (normally black is AC In and white is

AC Return) Attach the ground wire of the cord (normally green) to the green ground screw located on the inside back of the case. Slide the lens and circuit board assembly back into the case, replace the end cap and secure with the four phillips head screws.

DDC4-RS

Remove the two phillips head screws from the left or the right end cap and remove. Slide the front panel assembly out of the case. Carefully flip the front panel assembly over and lay it face down on a clean, smooth work surface. Remove one of the vent caps from the case of the wall clock and route the power cord through it to the back of the display panel. (If the power cord will be routed through the back-of-the-clock conduit access, route the cord through the gang box and conduit access hole to the back of the circuit board assembly). Strip away 1/2" of the protective shield from each wire of the power cord. Locate the two black wires leading from J1 (see figure 2, page 9) and attach the AC In line of the cord to one and the AC Return line to the other (normally black is AC In and white is AC Return). Attach the ground wire of the cord, (normally green) to the green ground screw located on the inside back of the case. Slide the front panel display back into the case, replace the end cap and secure with the two phillips head screws.

Wiring Installation - DDC2/4-RS Series

Secondary Wiring

The DDC Wall Clock comes with a detachable wiring harness to make installation easier. The wiring harness can be removed from the back of the main circuit board at position J1 as shown in figure 2 so wiring from the master clock can be attached to the wiring harness with the clock's Electronic Assembly removed. The leads from the wiring harness should be connected as shown in the diagrams in Appendix A.

RS485 Wiring

The DDC Wall Clock comes with a detachable wiring block to make installation easier. The wiring block can be removed from the back of the main circuit board at position JP4 as shown in figure 2 so wiring from the master clock can be attached without the need of holding the Wall Clock itself. Wiring should be connected as shown in the diagrams in Appendix C.

DDC-TC Wiring

The DDC Wall Clock comes with a detachable wiring block to make installation easier. The wiring block can be removed from the back of the main circuit board at position JP2 as shown in figure 2 so wiring from the Timer Control Panel can be attached without the need of holding the Wall Clock itself. Wiring should be connected as shown in the diagrams in Appendix D.

Replacing an Existing DDC4 Wall Clock

When replacing an older style DDC4 Wall Clock it will be necessary to remove any connectors used by the older style clock and attach the wires to the new DDC Series Wall Clock as described above.

Board Layout Diagram

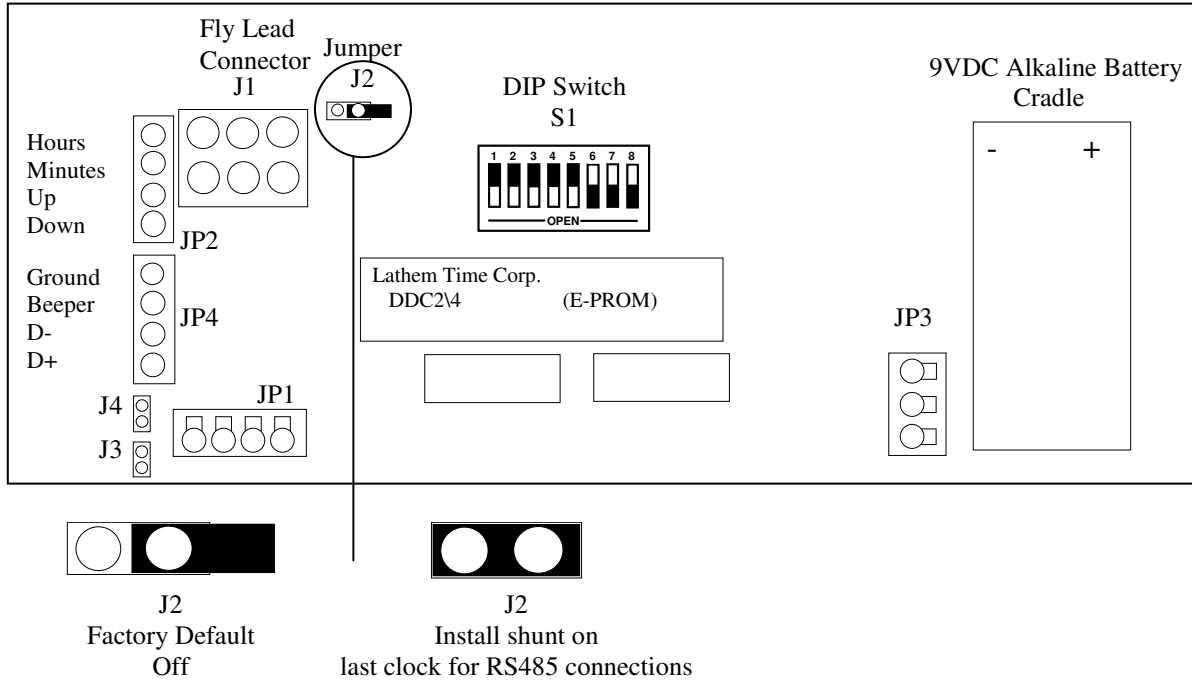

Figure 2

Mounting - DDC2 / DDC4 Series

The DDC Series Wall Clocks can be mounted directly to a wall, to a single gang outlet box, double hung from the wall or double hung from the ceiling. When deciding where the clock will be mounted, keep in mind that 115VAC power may be required depending on the installation type.

See page 14, figure 3.

Mounting to a Wall

Tools required for mounting the clock:

Drill with a 5/16" bit
Hammer
Phillips head screwdriver
Wall anchors
Pencil

DDC2

- » After deciding the location where the clock will be mounted, make two marks 7" apart and horizontal.

Note: If mounting near a ceiling, make sure the holes are at least 2 1/4" away from the ceiling.

Note: Make sure you have at least 10 1/2" of side clearance on one side in order to remove the lens and circuit board assembly.

- » Drill a 5/16" hole at each mark
- » Insert a wall anchor in each hole and tap it flush to the wall with the hammer.
- » Insert a screw into each wall anchor leaving 1/4" exposed.
- » Remove the four phillips head screws from the left or the right end cap and remove. Slide the lens and circuit board assembly out of the case and set aside.
- » Line up the two keyholes on the back of the case and slip over the two screws and tighten securely. (The lower mounting holes can be marked at this point, the case removed, holes drilled and wall anchors installed if so desired)
- » Remove the desired vent cap that any required wiring will route through. (If the wiring will be installed through the back-of-the-clock conduit access, route the fly leads of the clock's Cable Harness Assembly from the interior of the clock through the hole in the Clock's rear plate. Use wire nuts or crimp connectors to join these leads with the power and synch signal cable in the gang box behind the clock to eliminate possible snagging when the circuit board assembly is removed or replaced. If RS-485 signaling is used, attach the signal pair to the mini Terminal Block Plug and pass the cable from behind the clock, through the hole into the clock's interior).
- » Route the 6-position plug (and optional RS485 cable) to the circuit board assembly and attach.

- » Slide the lens and circuit board assembly back into the case, replace the end cap and secure with the four phillips head screws.

DDC4

- » After deciding the location where the clock will be mounted, make two marks 12" apart and horizontal.
Note: If mounting near a ceiling, make sure the holes are at least 2 1/4" away from the ceiling.
Note: Make sure you have at least 16" of side clearance on one side in order to remove the front panel.
- » Drill a 5/16" hole at each mark
- » Insert a wall anchor and tap it flush to the wall with the hammer.
- » Insert a screw into each wall anchor leaving 1/4" exposed.
- » Remove the two phillips head screws from the left or the right end cap and remove. Slide the front panel assembly out of the case and set aside.
- » Line up the two keyholes on the back of the case and slip over the two screws and tighten securely. (The lower mounting holes can be marked at this point, the case removed, holes drilled and wall anchors installed if so desired)
- » Remove the desired vent cap that any required wiring will route through. (If the wiring will be installed through the back-of-the-clock conduit access, route the fly leads of the clock's Cable Harness Assembly from the interior of the clock through the hole in the Clock's rear plate. Use wire nuts or crimp connectors to join these leads with the power and synch signal cable in the gang box behind the clock to eliminate possible snagging when the circuit board assembly is removed or replaced. If RS-485 signaling is used, attach the signal pair to the mini Terminal Block Plug and pass the cable from behind the clock, through the hole into the clock's interior).
- » Route the 6-position plug (and optional RS485 cable) to the circuit board assembly and attach.
- » Slide the front panel display back into the case, replace the end cap and secure with the two phillips head screws.

Mounting to a Single Gang Box

Two mounting holes have been located in the center of the case 2 1/4" apart for mounting to a single gang wall box. A 7/8" hole has been placed between the mounting holes that will accept conduit if desired.

See page 14, figure 3.

DDC2

Note: If mounting near a ceiling, make sure the top of the single gang box is at least 2 1/4" away from the ceiling.

Note: Make sure you have at least 10 1/2" of side clearance on one side in order to remove the lens and circuit board assembly.

- » Remove the four phillips head screws from the left or the right end cap and remove. Slide the lens and circuit board assembly out of the case and set aside.
- » Remove the desired vent cap that any required wiring will route through. (If the wiring will be installed through the back-of-the-clock conduit access, route the fly leads of the clock's Cable Harness Assembly from the interior of the clock through the hole in the Clock's rear plate. Use wire nuts or crimp connectors to join these leads with the power and synch signal cable in the gang box behind the clock to eliminate possible snagging when the circuit board assembly is removed or replaced. If RS-485 signaling is used, attach the signal pair to the mini Terminal Block Plug and pass the cable from behind the clock, through the hole into the clock's interior).
- » Line the two holes in the case up to the single gang box and insert proper screws for the single gang box and tighten securely.
- » Route the 6-position plug (and optional RS485 cable) to the circuit board assembly and attach.
- » Slide the lens and circuit board assembly back into the case, replace the end cap and secure with the four phillips head screws.

DDC4

Note: If mounting near a ceiling, make sure the top of the single gang box is at least 2 1/4" away from the ceiling.

Note: Make sure you have at least 16" of side clearance on one side in order to remove the front panel.

- » Remove the two phillips head screws from the left or the right end cap and remove. Slide the front panel assembly out of the case and set aside.
- » Remove the desired vent cap that any required wiring will route through. (If the wiring will be installed through the back-of-the-clock conduit access, route the fly leads of the clock's Cable Harness Assembly from the interior of the clock through the hole in the Clock's rear plate. Use wire nuts or crimp connectors to join these leads with the power and synch signal cable in the gang box behind the clock to eliminate possible snagging when the circuit board assembly is removed or replaced. If RS-485 signaling is used, attach the signal pair to the mini Terminal Block Plug and pass the cable from behind the clock, through the hole into the clock's interior).
- » Line the two holes in the case up to the single gang box and insert proper screws for the single gang box and tighten securely.
- » Route the 6-position plug (and optional RS485 cable) to the circuit board assembly and attach.

- » Slide the front panel display back into the case, replace the end cap and secure with the two phillips head screws.

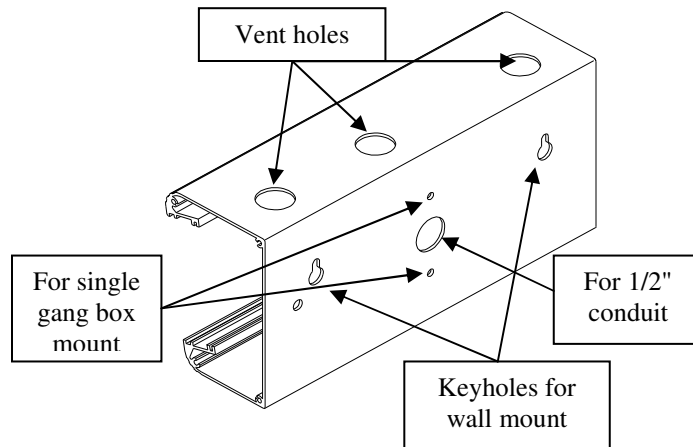

Figure 3

Double Mount - Wall

DDC2 Requires optional mounting kit (SAM0630)

DDC4 Requires optional mounting kit (SAM0625)

Tools required for mounting the clock:

Flat blade screwdriver

Phillips head screwdriver

15/16" open end wrench

The double wall mount plate attaches to a double or single gang box installed securely in the wall. Required wiring should be available through the gang box at time of installation.

- » Remove the two chase nipples from the mounting plate posts.
- » Run the required wiring from the gang box through one of the mounting posts of the mounting plate.
- » Secure the mounting plate securely to the gang box with the proper screws. (not supplied)

Note: The long dimension of the mounting plate must be perpendicular to the ground to assure proper alignment of wall clocks.

See page 15, figure 4 for DDC2 details.

See page 16, figure 5 for DDC4 details.

DDC2 (Double Mount - Wall)

- » Remove the four phillips head screws from the left and the right end caps of the two DDC2 clocks and remove. Slide the lenses and circuit board assemblies out of the cases and set aside.
- » Place the two DDC2 clocks back to back and secure by inserting a #10 screw through the two key holes and the two lower mounting holes using lock washers and nuts supplied with the mounting kit.
- » Attach the modified end caps to the end of the clocks that will be attached to the wall mount plate using the original end cap screws.
- » Run the required wiring through the matching hole in the modified end cap.
- » Line the two posts from the mounting plate up with the two holes of the modified end caps. Insert the chase nipples through the holes of the modified end caps and secure to the mounting plate with a 15/16" wrench.
- » Slide the circuit board assemblies in partially. Secure the required wiring and install the battery if used.
- » Slide the circuit board assemblies in fully along with the lenses. Install the end caps and secure each with its four screws.
- » Discard or store the two original end caps the modified end caps replaced.

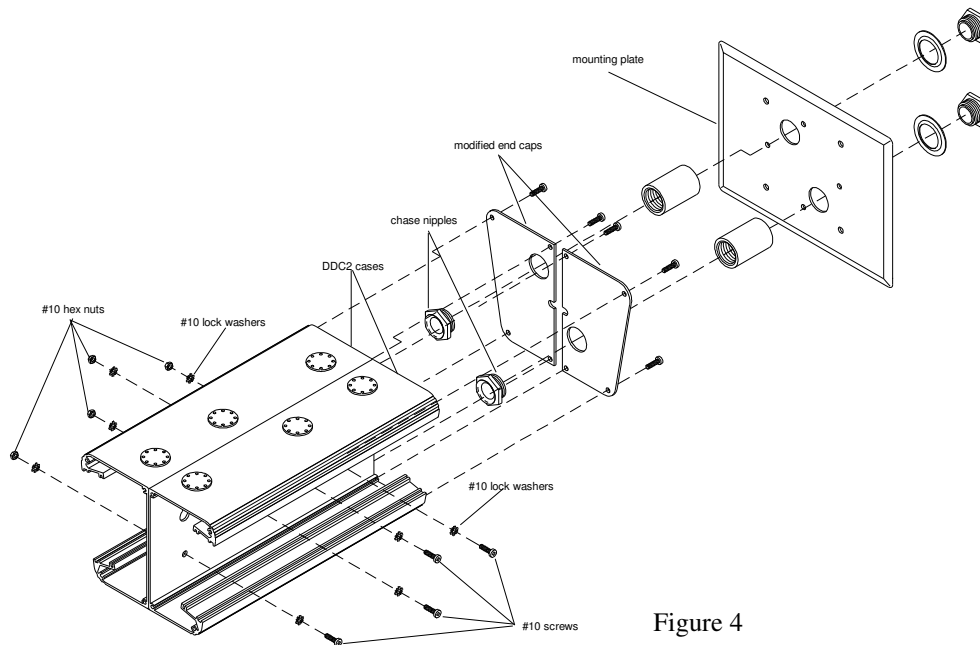

Figure 4

DDC4 (Double Mount - Wall)

- » Remove the two phillips head screws from the left and the right end caps of the two DDC4 clocks and remove. Slide the front panel assemblies out of the cases and set aside.
- » Place the two DDC4 clocks back to back and secure by inserting a #10 screw through the two key holes and the two lower mounting holes using lock washers and nuts supplied with the mounting kit.
- » Attach the modified end cap to the end of the clocks that will be attached to the wall mount plate using the original end cap screws.
- » Align the holes of the end cap support plate with the holes in the modified end cap and secure with 4 #6 phillips head screws (supplied)
- » Line the two posts from the mounting plate up with the two holes of the modified end cap. Insert the chase nipples through the holes of the modified end cap and secure to the mounting plate with a 15/16" wrench.
- » Slide the front panel assemblies in partially. Secure the required wiring and install the battery if used.
- » Slide the front panel assemblies in fully. Install the end caps and secure each with its two screws.
- » Discard or store the two original end caps the modified end cap replaced.

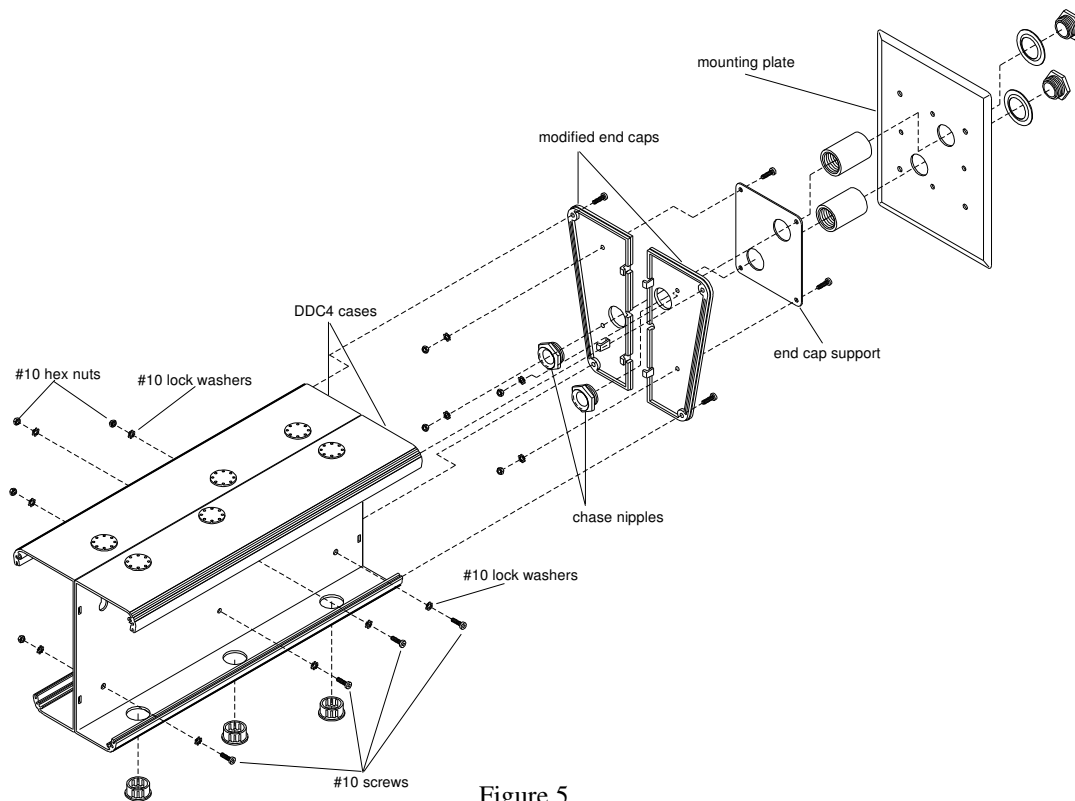

Figure 5

Double Mount - Ceiling

Requires optional mounting kit (SAM0626)

Tools required for mounting the clock:

Flat blade screwdriver
Phillips head screwdriver
15/16" open end wrench

The double ceiling mount plate attaches to a double or single gang box installed securely in the ceiling. Required wiring should be available through the gang box at time of installation.

- » Remove the two chase nipples from the mounting plate posts.
- » Run the required wiring from the gang box through one of the mounting posts of the mounting plate.
- » Secure the mounting plate securely to the gang box with the proper screws. (not supplied)

Note: When mounting DDC2 clocks, the short side of the mounting plate must be parallel to the long side of the clocks. When mounting DDC4 clocks, the long side of the mounting plate must be parallel to the long side of the clocks.

See page 18, figure 6 for DDC2 details.

See page 19, figure 7 for DDC4 details

DDC2 (Double Mount - Ceiling)

Note: Make sure you have at least 10 1/2" of side clearance on one side in order to remove the lens and circuit board assembly.

- » Remove the four phillips head screws from the left and the right end caps of the two DDC2 clocks and remove. Slide the lenses and circuit board assemblies out of the cases and set aside.
- » Place the two DDC2 clocks back to back and secure by inserting a #10 screw through the two key holes and the two lower mounting holes using lock washers and nuts supplied with the mounting kit. *Note: At this point, if the DDC2 clocks will be mounted too near a wall on one side to secure the end caps, install the "wall side" end caps now.*
- » Remove the center vent cap from the top of each DDC2 clock.
- » Line the two posts from the mounting plate up with the vent holes of the DDC2 clocks. Insert the chase nipples through the vent holes and secure to the mounting plate with a 15/16" wrench.
- » Slide the circuit board assemblies in partially. Secure the required wiring and install the battery if used.
- » Slide the circuit board assemblies in fully along with the lenses. Install the end caps and secure each with its four screws.

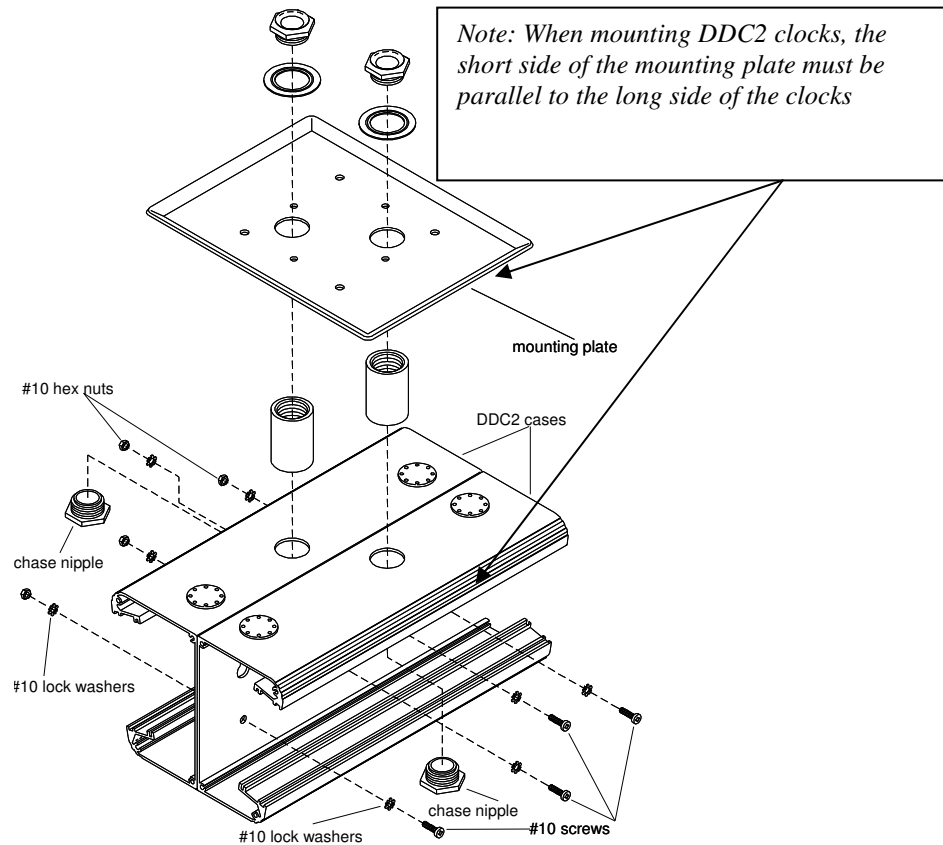

Figure 6

DDC4 (Double Mount - Ceiling)

Note: Make sure you have at least 16" of side clearance on one side in order to remove the front panel assembly.

- » Remove the two phillips head screws from the left and the right end caps of the two DDC4 clocks and remove. Slide the front panel assemblies out of the cases and set aside.
- » Place the two DDC4 clocks back to back and secure by inserting a #10 screw through the two key holes and the two lower mounting holes using lock washers and nuts supplied with the mounting kit. *Note: At this point, if the DDC4 clocks will be mounted too near a wall on one side to secure the end caps, install the "wall side" end caps now.*
- » Remove the center vent cap from the top of each DDC4 clock.
- » Line the two posts from the mounting plate up with the vent holes of the DDC4 clocks. Insert the chase nipples through the vent holes and secure to the mounting plate with a 15/16" wrench.
- » Slide the front panel assemblies in partially. Secure the required wiring and install the battery if used.
- » Slide the front panel assemblies in fully. Install the end caps and secure each with its two screws.

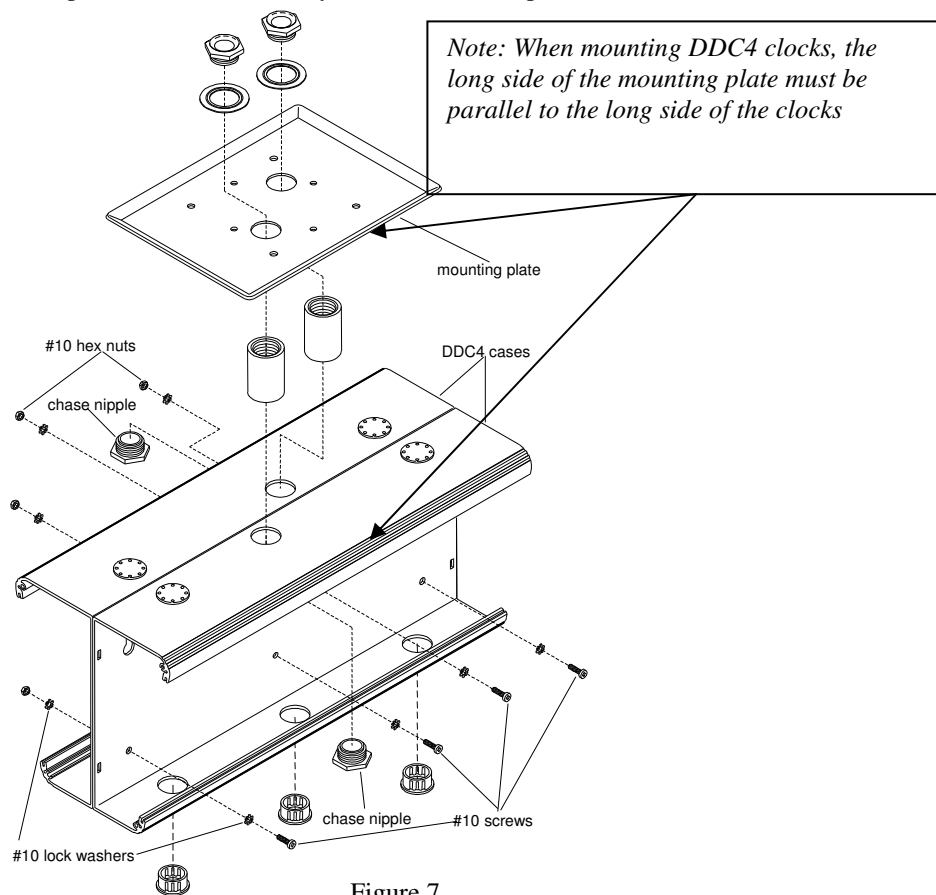

Figure 7

Setting the Time

Time is set on the DDC Series Wall Clocks by depressing buttons located on the left side of the front panel. There are two setting buttons, "H" for hour and "M" for minute.

- » To advance the hour or minute to the correct time one digit at a time press and release the proper button. Do this as many times as required until the correct time is displayed. When setting the hour, if the display is set to 12 Hour, a "dot" in the upper left corner of the display represents the PM hours.
- » To rapidly advance the hour or minute press and hold the proper button. Release the button when the correct time is displayed. When setting the hour, if the display is set to 12 Hour, a "dot" in the upper left corner of the display represents the PM hours.

Note: Setting the minutes past 59 will not cause the hour to advance.

Note: Avoid using sharp or pointed objects to set the time as damage to the buttons may occur. A standard pencil eraser is suggested.

Time Formats

The DDC2 / DDC4 Series Wall Clocks can be set to display in 12 Hour or 24 Hour format. When in 12-Hour format, a round LED in the upper left corner of the display indicates PM hours. When in 24 Hour format, the hours are displays in Military style. To set the display format, use Table 3 on page 4 to set switch 8 of S1.

Note: When switches 1-5 are set for any secondary type other than Stand-Alone, the display is forced to 12 Hour and the PM indicator does not illuminate.

12 Hour Format



AM

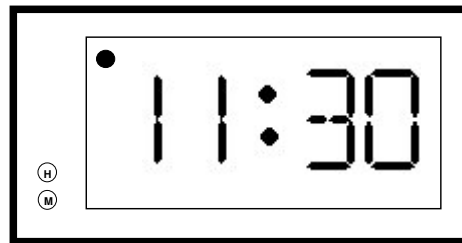

PM

24 Hour Format



Appendix A - DDC2-RS / 4-RS Secondary Clock Wiring Diagrams

Note: See Appendix B for DDC2-RS-24 / DDC4-RS-24 wiring.

Stand-Alone (115VAC)

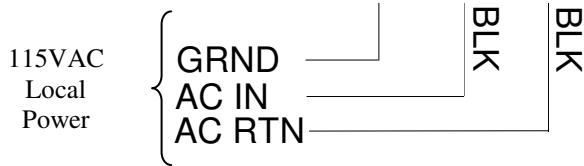
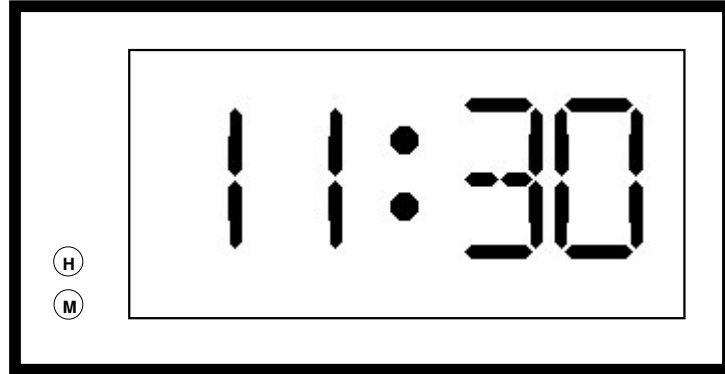

Hour and Minutes must be set manually. Use of a 9Volt alkaline battery is recommended to avoid resets after power failures.

Set switches 1-5 of S1 as shown.

■ Indicates depressed side of switch

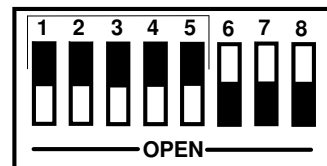

3-Wire Synchronous (115VAC)

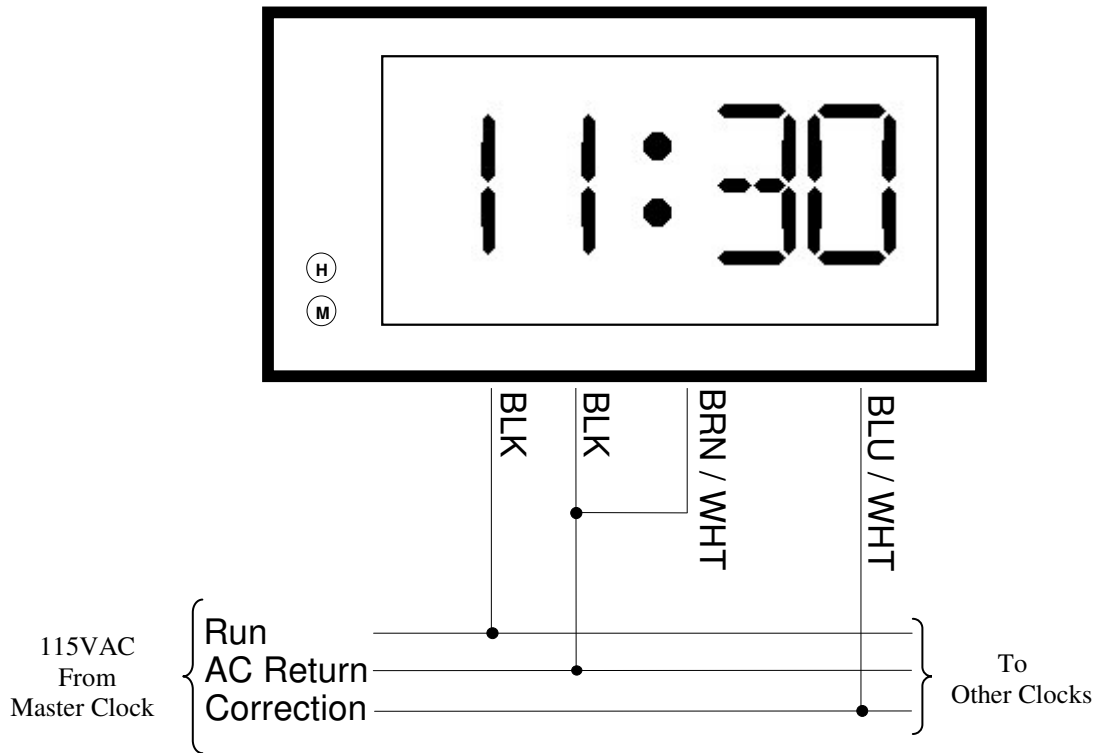

Clock will correct minutes hourly at HH:59 and hour and minutes twice daily at 5:59.

Set switches 1-5 of S1 as shown.

■ Indicates depressed side of switch

Wiring applies to secondary wall clocks such as:

Lathem type SS Cincinnati D10 IBM 77 Series

Simplex 77 Series, 93-9, 91-9, 941-9, 943-9

Stromberg 3000

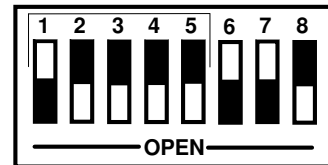

3-Wire Synchronous (24VAC Correction)

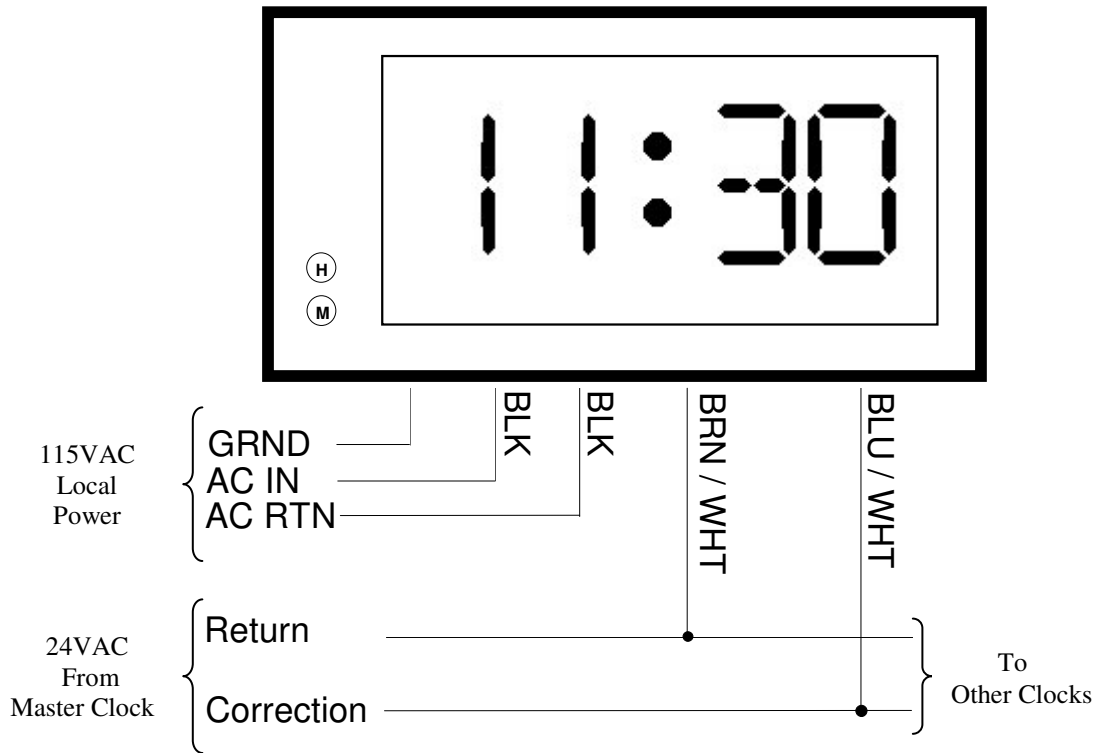

Clock will correct minutes hourly at HH:59 and hour and minutes twice daily at 5:59.

Set switches 1-5 of S1 as shown.

■ Indicates depressed side of switch

Wiring applies to secondary wall clocks such as:
 Lathem type SS Cincinnati D10 IBM 77 Series
 Simplex 77 Series, 93-9, 91-9, 941-9, 943-9
 Stromberg 3000

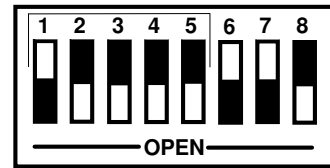

3-Wire minute Impulse (59th Minute)

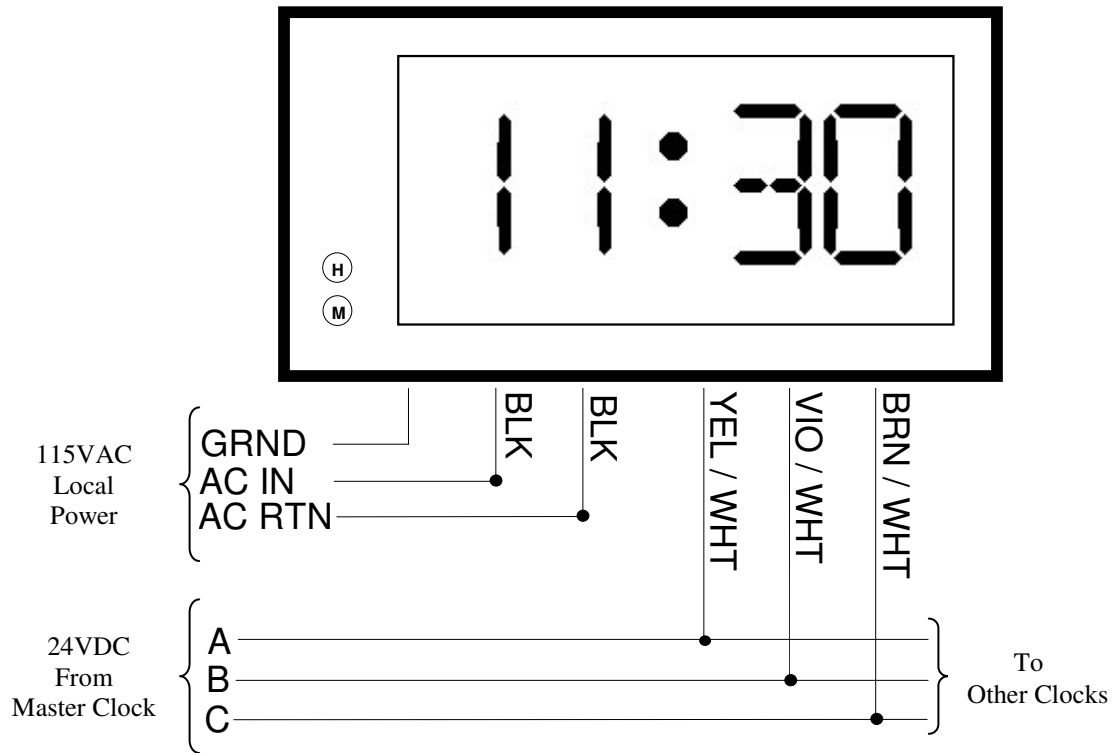

Clock must be set within 20 minutes of actual time for master to synchronize. Use of a 9Volt alkaline battery is recommended to avoid resets after power failures.

Set switches 1-5 of S1 as shown.

■ Indicates depressed side of switch

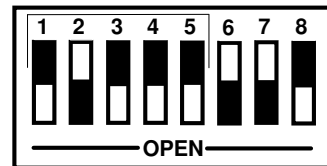

Wiring applies to secondary wall clocks such as:

- | | | |
|---|------------------|-------------------|
| Lathem ISC 3-Wire | Standard Impulse | Cincinnati D2, D4 |
| Stromberg Impulse | Edwards Impulse | Faraday Impulse |
| Simplex 75 Series, 91-4, 93-4, 941-4, 943-4 | | IBM 75 Series |

3-Wire Minute Impulse (59th Minute With 12 Hour Correction)

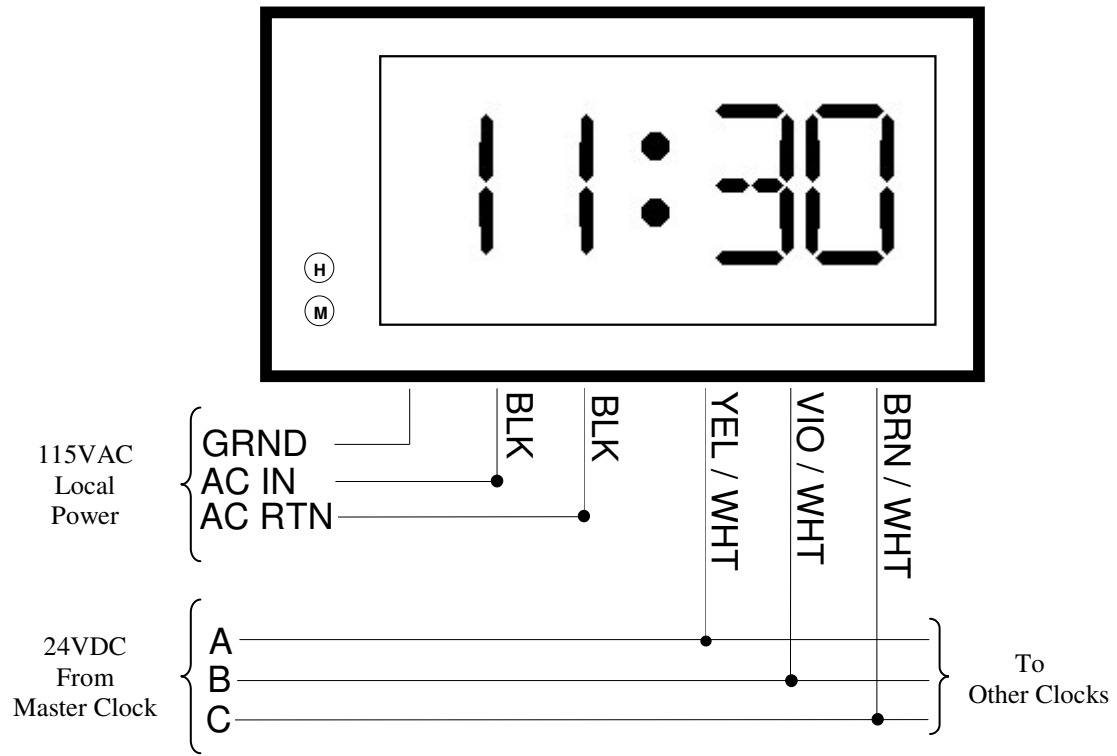

Clock will correct minutes hourly at HH:58 and hour and minutes twice daily at 5:58.

Set switches 1-5 of S1 as shown.

■ Indicates depressed side of switch

Wiring applies to secondary wall clocks such as:

Lathem ISC 3-Wire 12Hour Simplex 91, 941

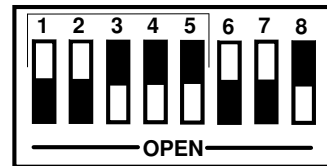

Standard Electric Synchronous

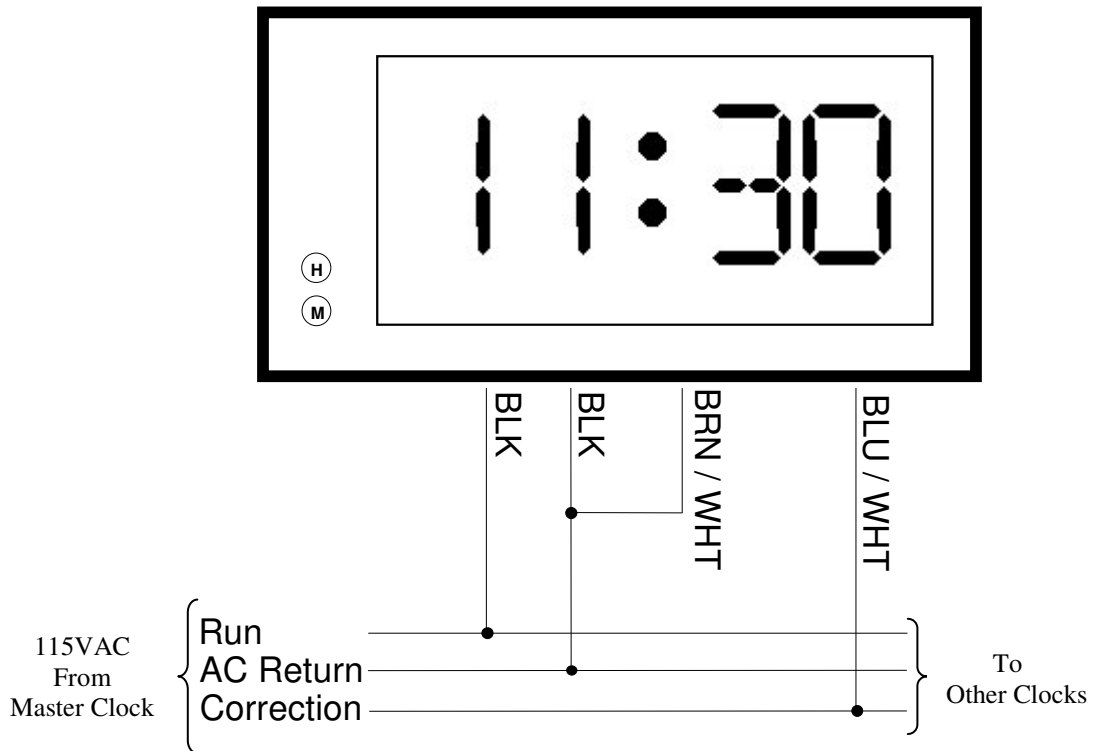

Clock will correct minutes hourly at HH:59 and hour and minutes twice daily at 5:12.

For 24VAC correction, use wiring shown on page 23

Set switches 1-5 of S1 as shown.

■ Indicates depressed side of switch

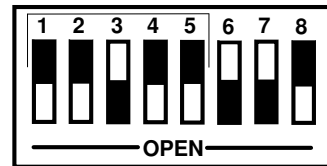

Standard Electric AR-2A 2-Wire Dual Voltage

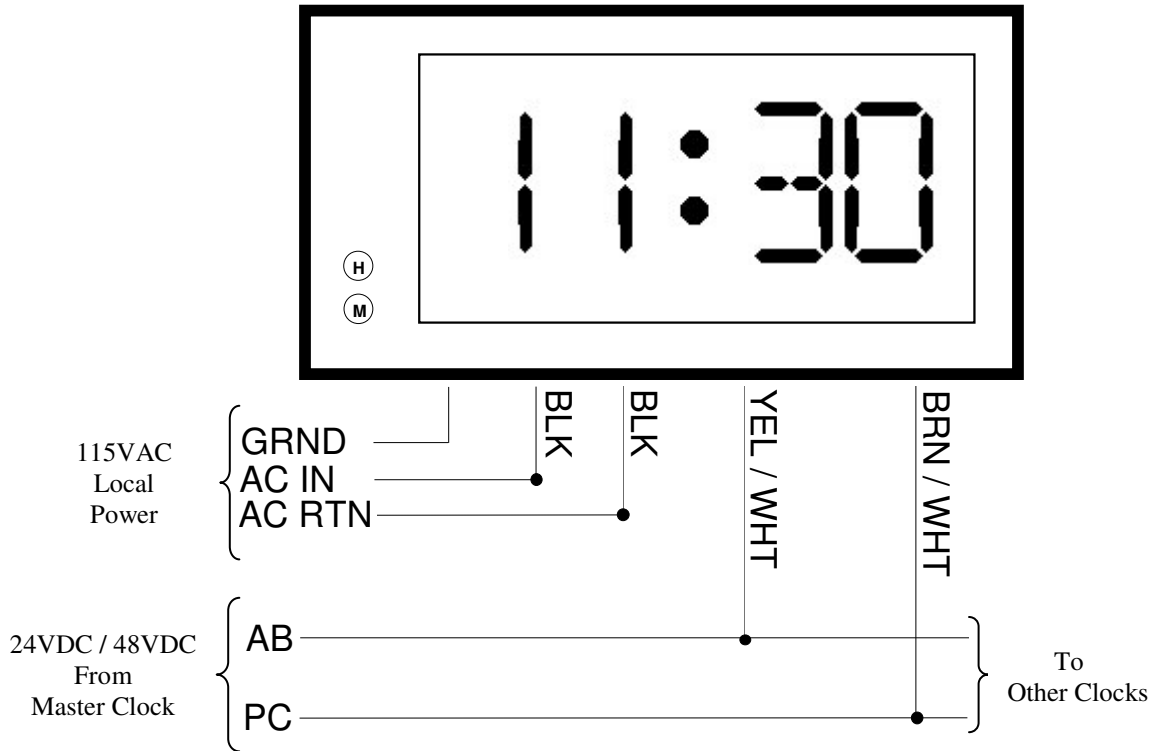

Clock must be set to actual time. Use of a 9Volt alkaline battery is recommended to avoid resets after power failures.

Set switches 1-5 of S1 as shown.

■ Indicates depressed side of switch

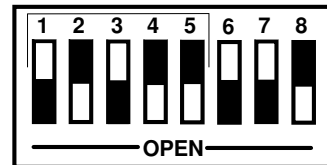

Standard Electric AR-2 2-Wire Dual Voltage

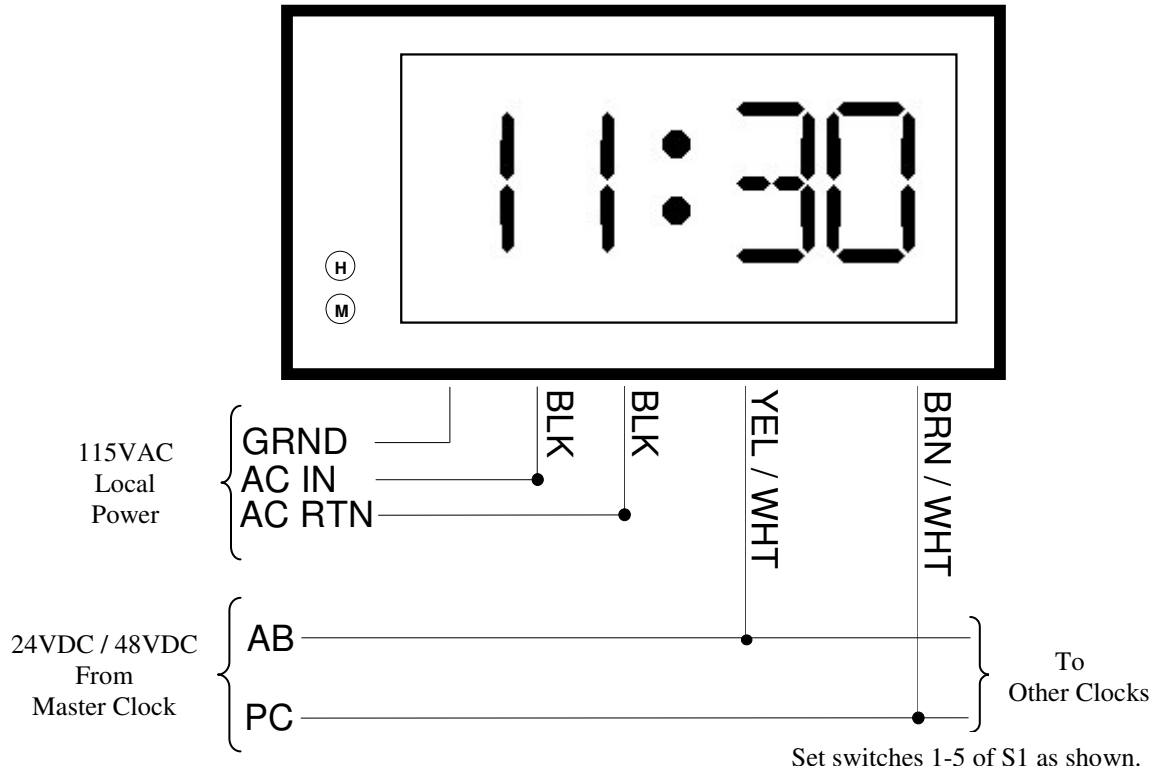

Clock must be set to actual time. Use of a 9Volt alkaline battery is recommended to avoid resets after power failures.

■ Indicates depressed side of switch

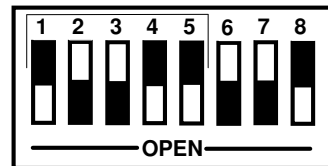

Synchronous Wired

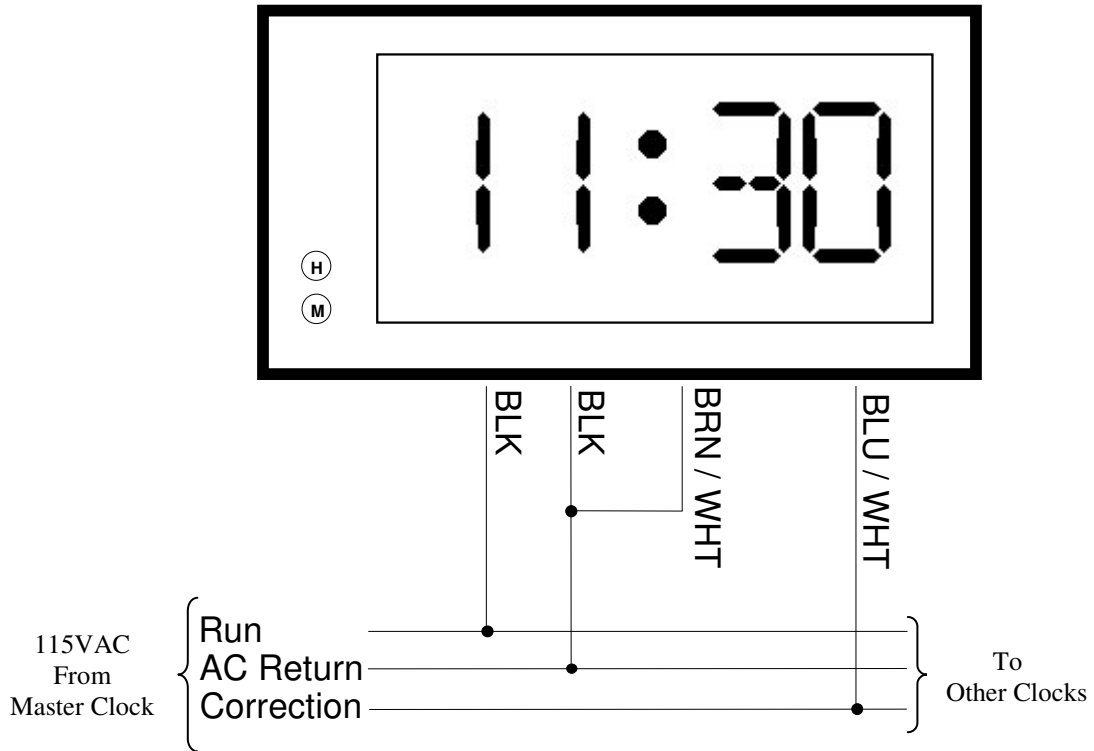

Clock will correct minutes hourly at HH:58 and hour and minutes twice daily beginning at 5:05.

For 24VAC correction, use wiring shown on page 23

Set switches 1-5 of S1 as shown.

■ Indicates depressed side of switch

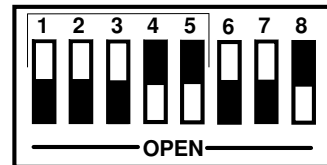

Wiring applies to secondary wall clocks such as:

- Cincinnati D8
- Faraday
- Honeywell ST402A

Simplex 59th Minute Dual Motor

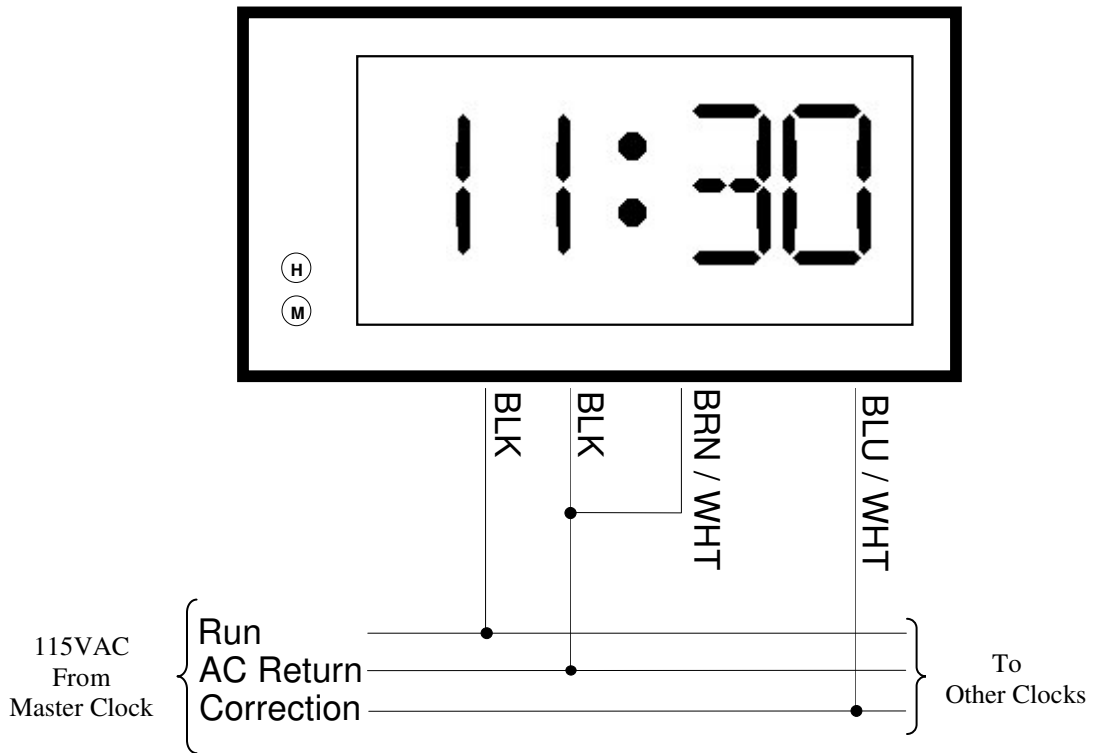

Clock must be set to proper hour. Clock will correct minutes hourly at HH:58. . Use of a 9Volt alkaline battery is recommended to avoid resets

For 24VAC correction, use wiring shown on page 23

Set switches 1-5 of S1 as shown.

■ Indicates depressed side of switch

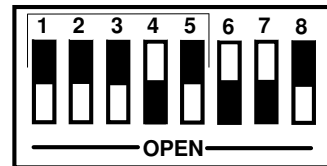

Simplex 45th Minute Dual Motor

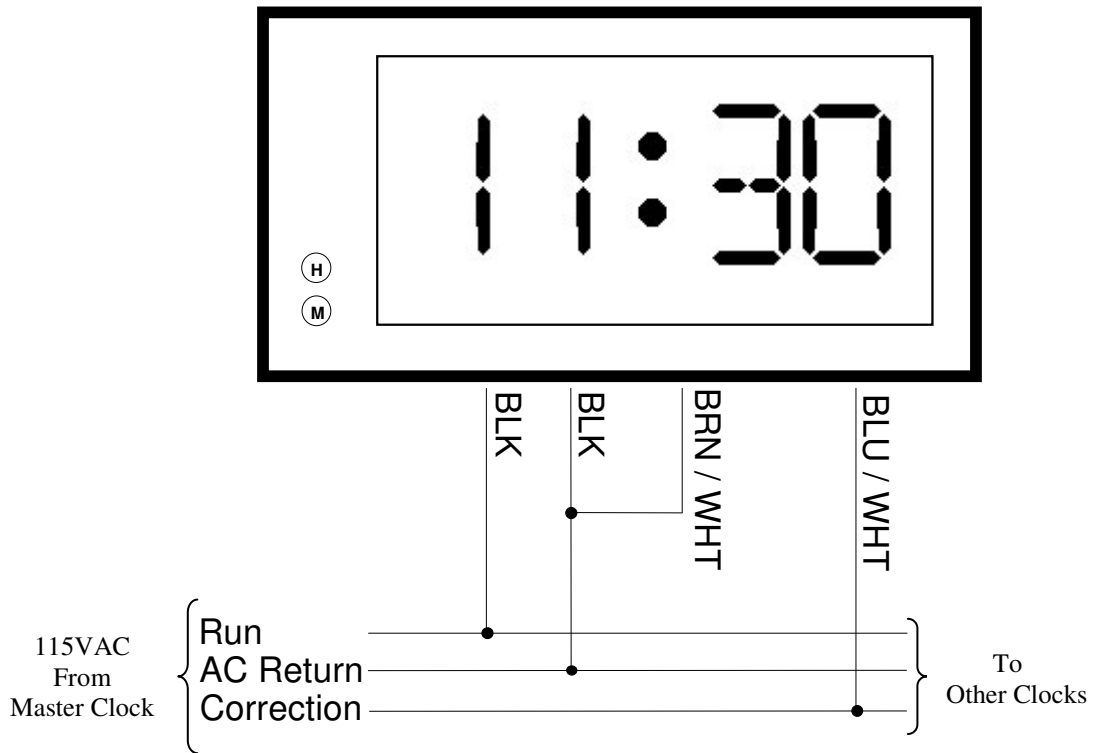

Clock must be set to proper hour. Clock will correct minutes hourly at HH:45. . Use of a 9Volt alkaline battery is recommended to avoid resets

For 24VAC correction, use wiring shown on page 23

Set switches 1-5 of S1 as shown.

■ Indicates depressed side of switch

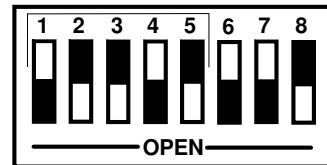

Edwards Dual Motor

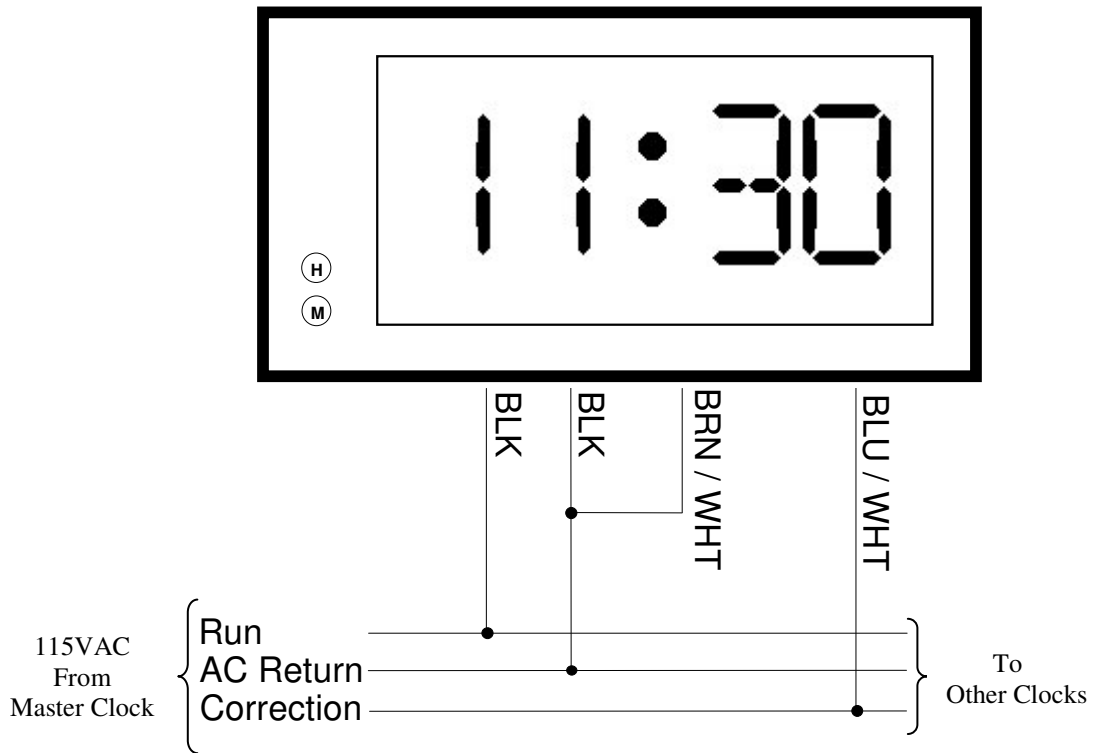

Clock must be set to actual time. Use of a 9Volt alkaline battery is recommended to avoid resets after power failures.

For 24VAC correction, use wiring shown on page 23

Set switches 1-5 of S1 as shown.

■ Indicates depressed side of switch

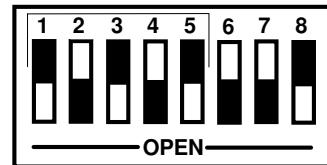

Standard Electric AR-3 3-Wire Minute Impulse

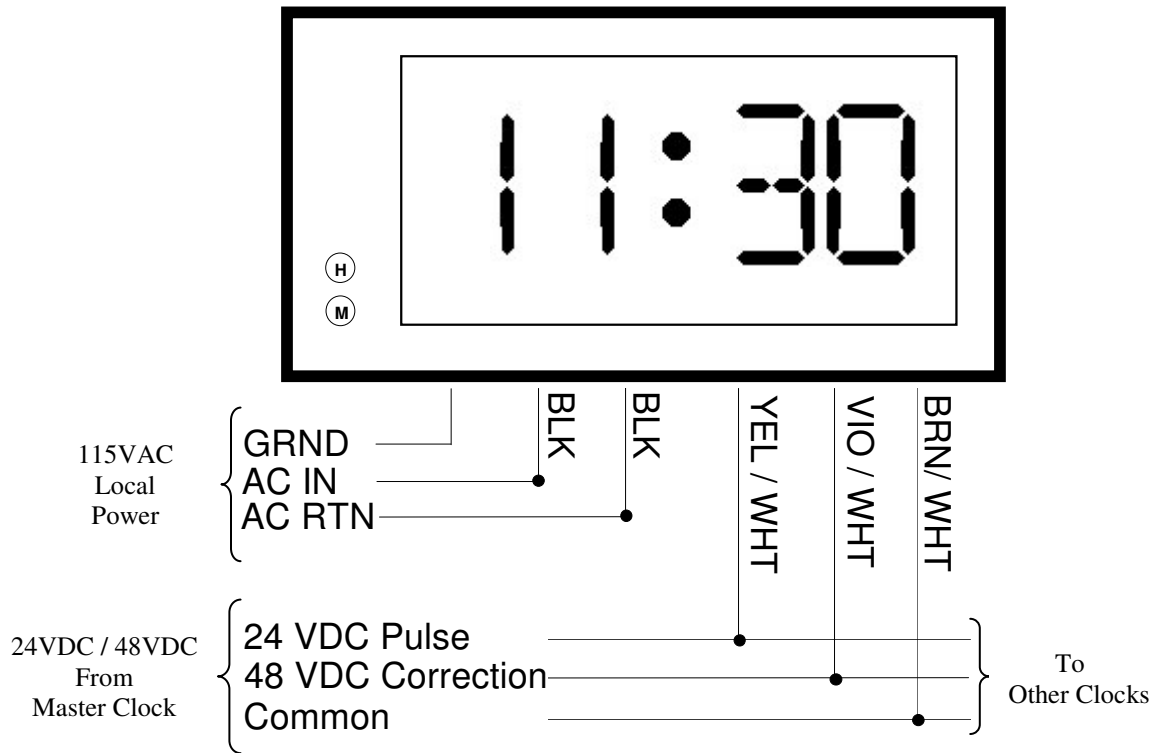

Clock must be set to actual time. Use of a 9Volt alkaline battery is recommended to avoid resets after power failures.

Set switches 1-5 of S1 as shown.

■ Indicates depressed side of switch

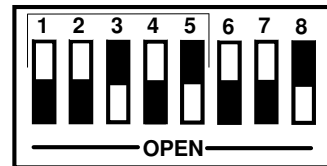

National Synchronous Wired

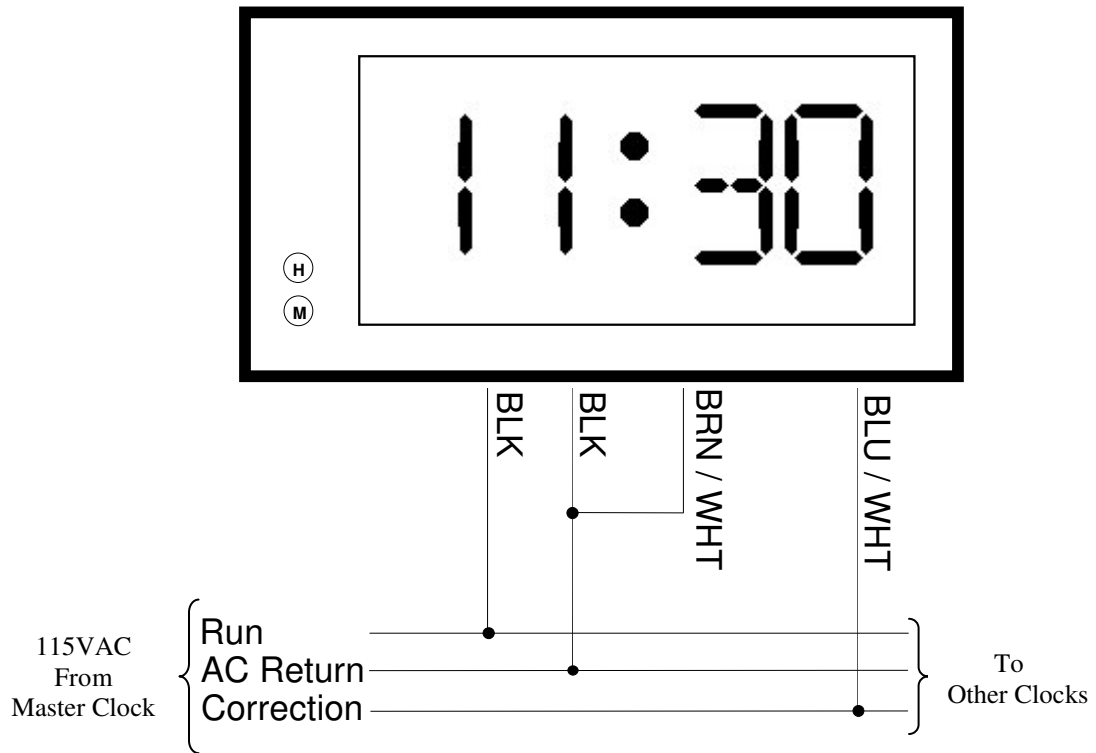

Clock will correct minutes hourly at HH:00 and hour and minutes twice daily at 6:00.

For 24VAC correction, use wiring shown on page 23

Set switches 1-5 of S1 as shown.

■ Indicates depressed side of switch

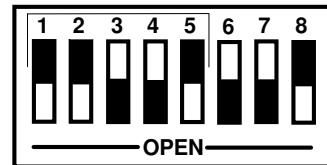

Stromberg Synchronous Wired (56th Minute)

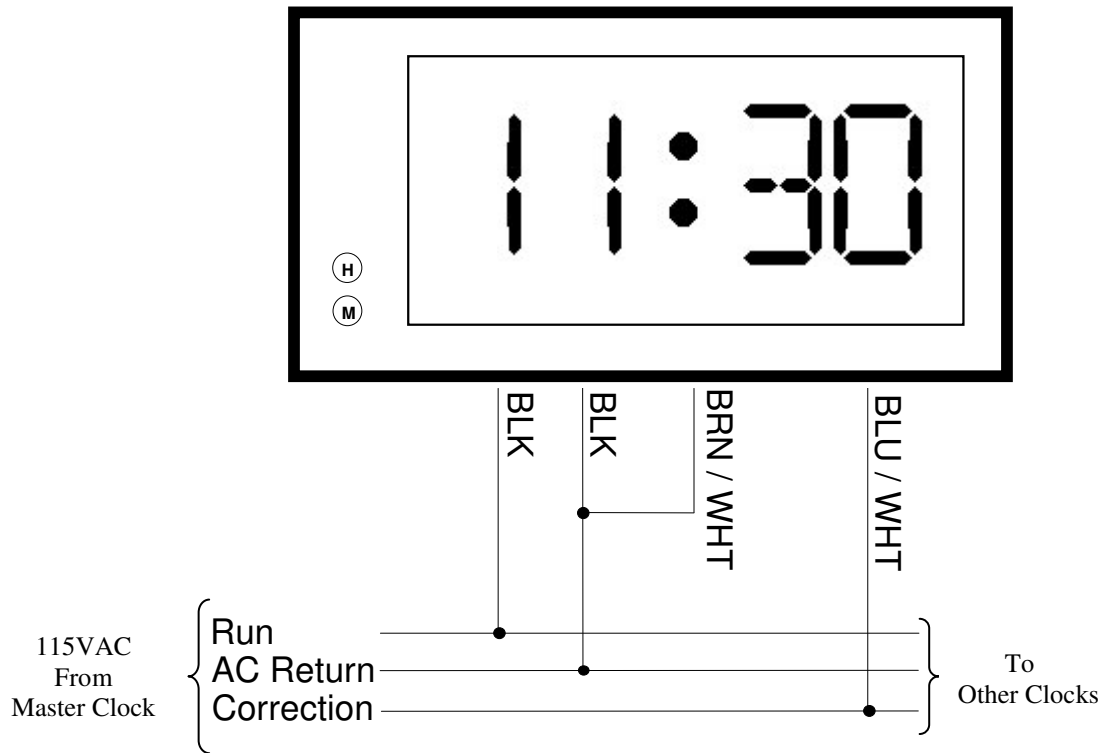

Clock will correct minutes hourly at HH:56 and hour and minutes twice daily at 11:56.

For 24VAC correction, use wiring shown on page 23

Set switches 1-5 of S1 as shown.

■ Indicates depressed side of switch

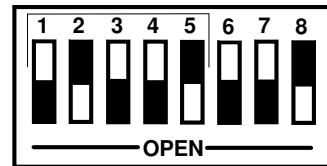

Cincinnati D1

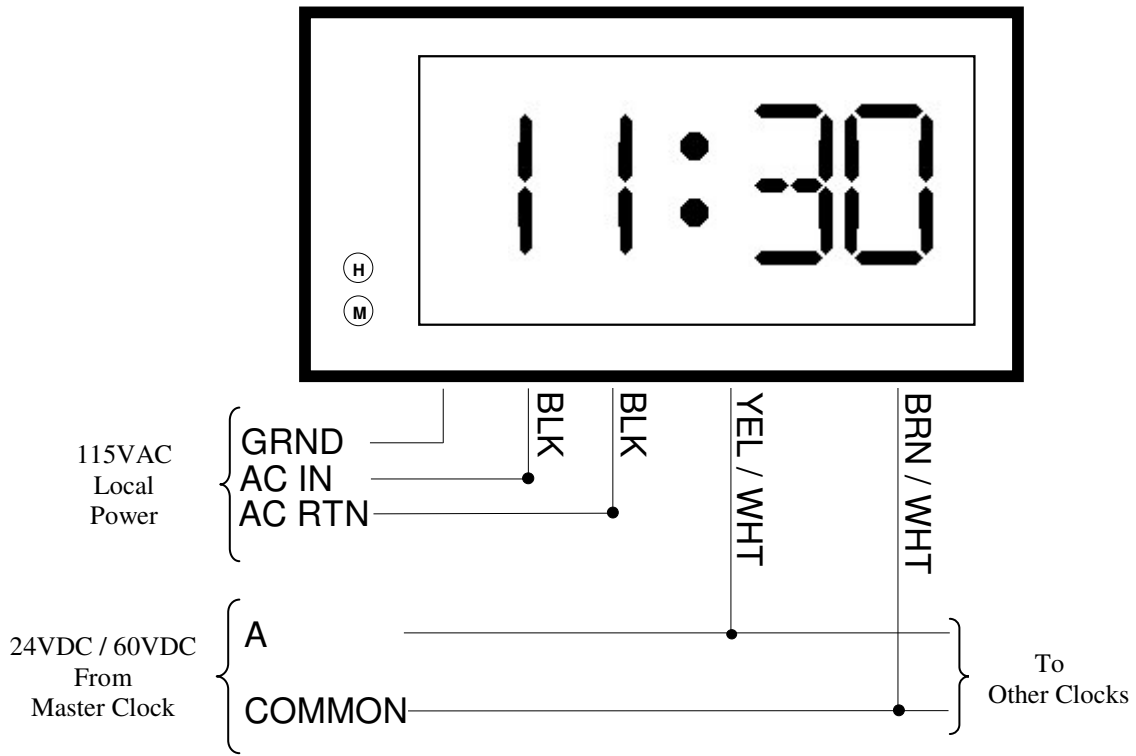

Clock must be set within 20 minutes of actual time for master to synchronize. Use of a 9Volt alkaline battery is recommended to avoid resets after power failures.

Set switches 1-5 of S1 as shown.

■ Indicates depressed side of switch

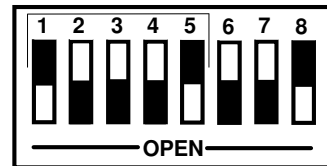

Cincinnati D6, Edwards 2406

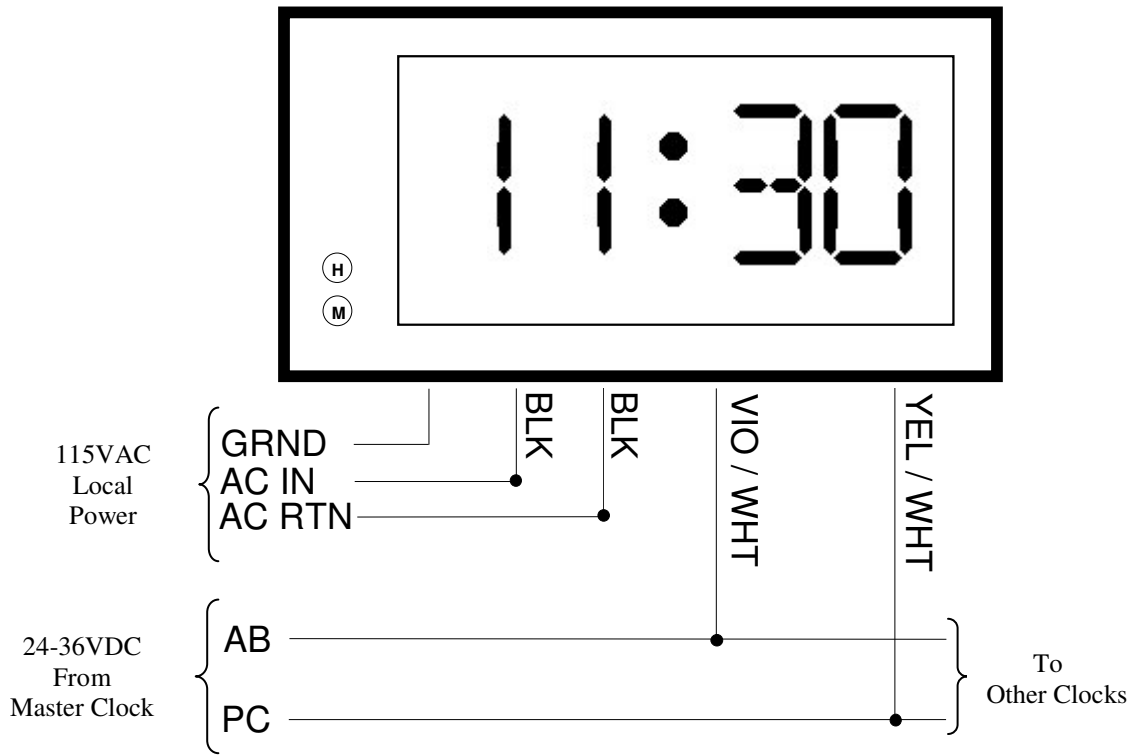

Clock must be set within 20 minutes of actual time for master to synchronize. Use of a 9Volt alkaline battery is recommended to avoid resets after power failures.

Set switches 1-5 of S1 as shown.

■ Indicates depressed side of switch

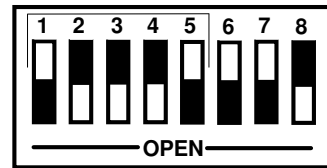

2-Wire Pulse Alternating (24VDC)

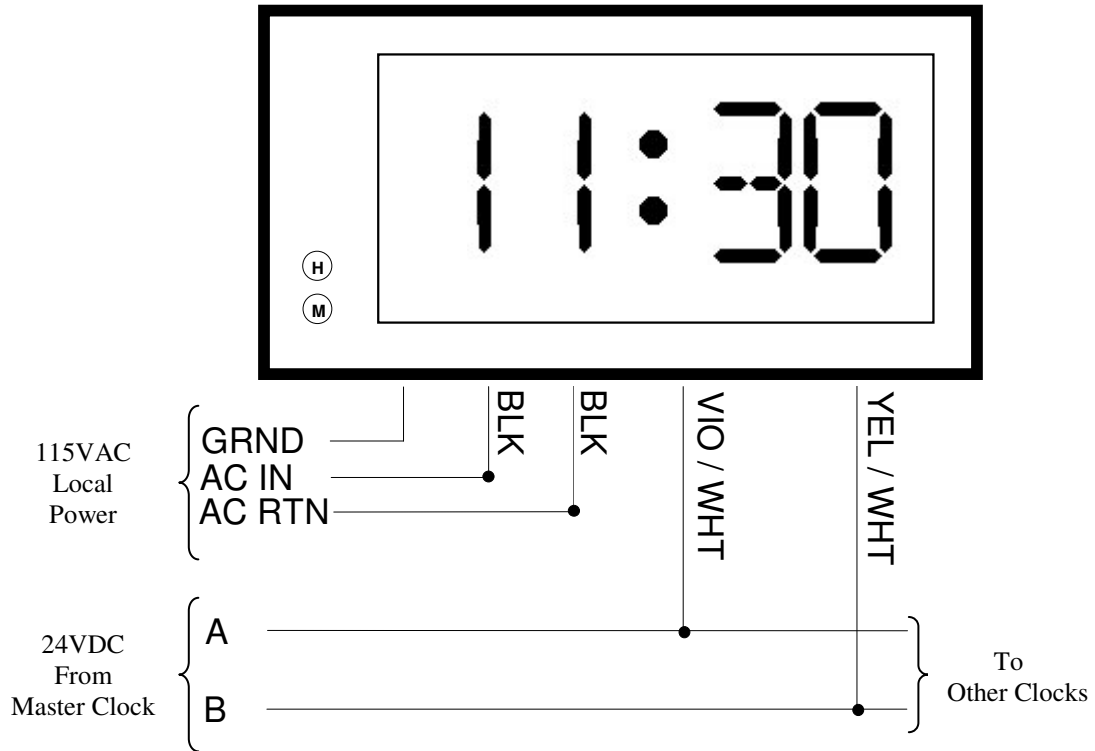

Clock must be set within 20 minutes of actual time for master to synchronize. Use of a 9Volt alkaline battery is recommended to avoid resets after power failures.

Set switches 1-5 of S1 as shown.

■ Indicates depressed side of switch

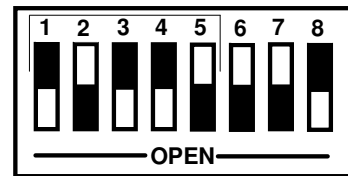

Electronic Coded

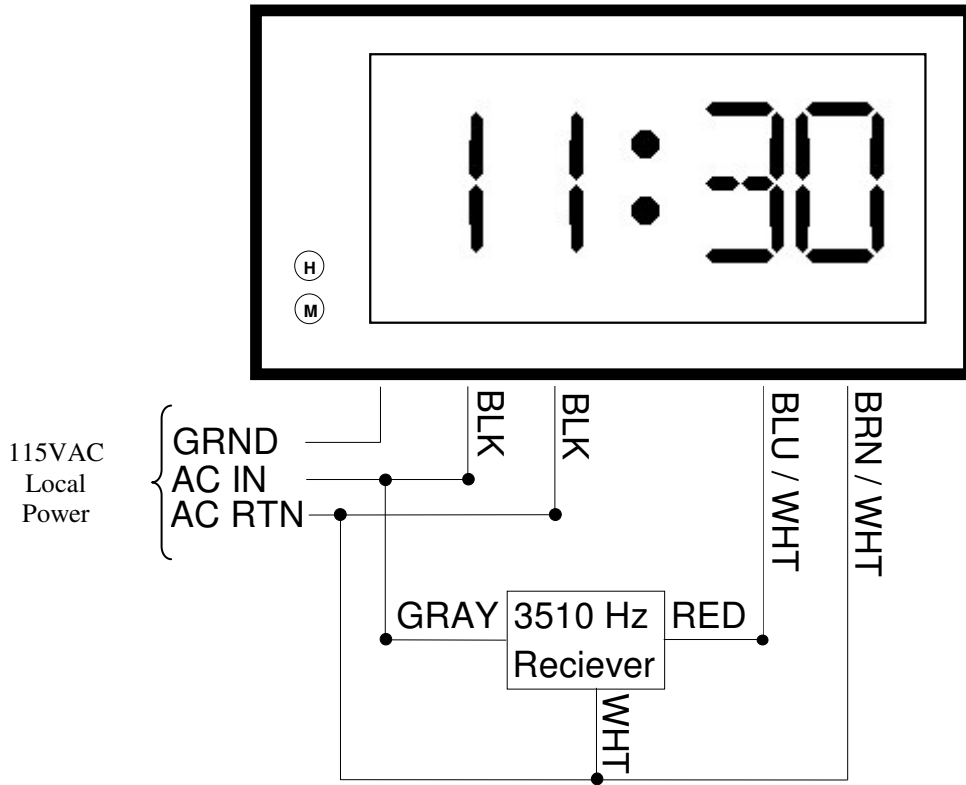

Requires 3510Hz receiver (not supplied)

Set switches 1-5 of S1 as shown.

Clock will correct minutes hourly at HH:57 and hour and minutes twice daily at 5:57.

■ Indicates depressed side of switch

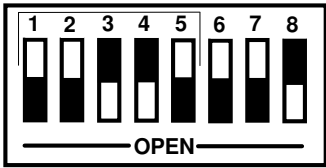

Straight Frequency

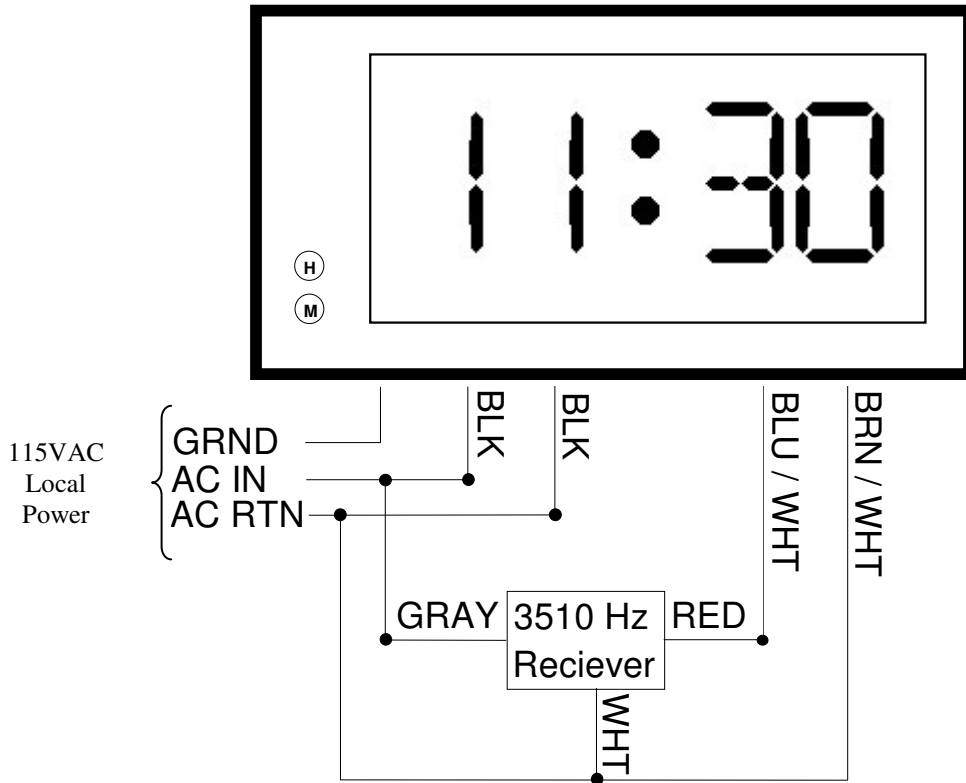

Requires 3510Hz receiver (not supplied)

Set switches 1-5 of S1 as shown.

Clock will correct minutes hourly at HH:57 and hour and minutes twice daily at 5:57.

■ Indicates depressed side of switch

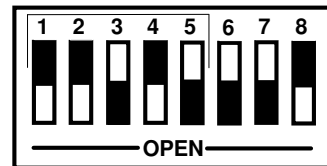

3-Wire Minute Impulse (58th Minute)

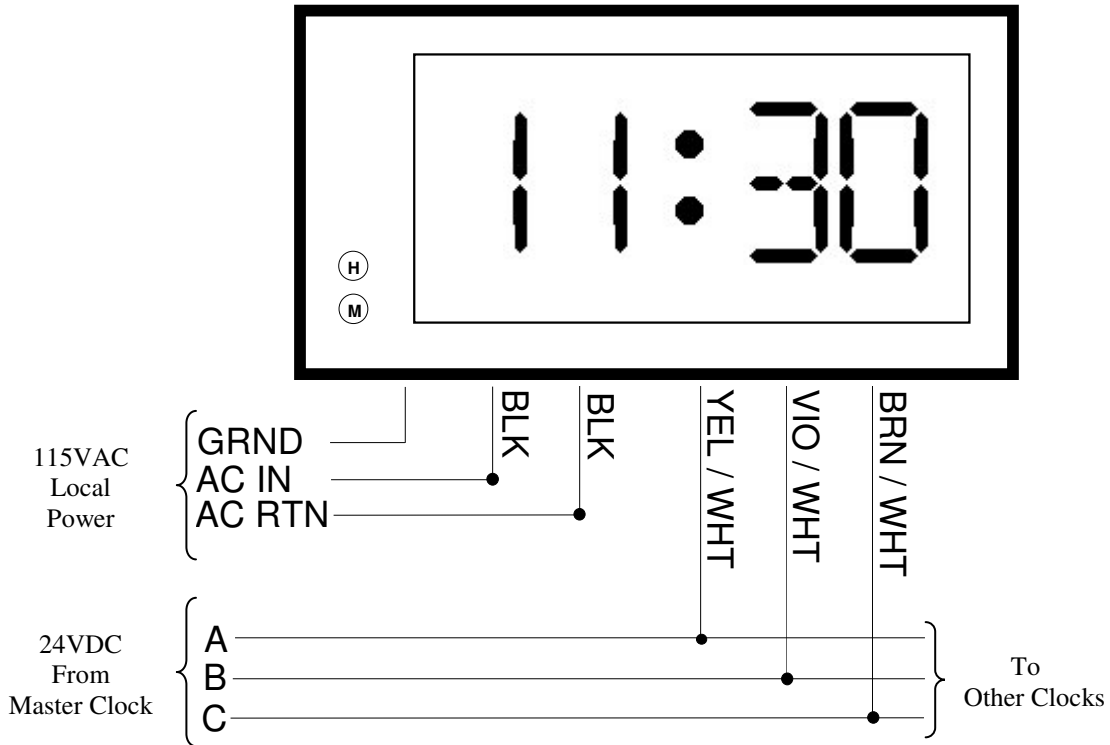

Clock must be set within 20 minutes of actual time for master to synchronize. Use of a 9Volt alkaline battery is recommended to avoid resets after power failures.

Set switches 1-5 of S1 as shown.

■ Indicates depressed side of switch

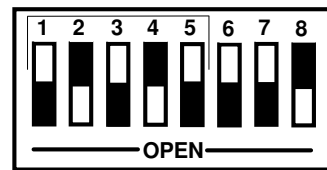

3-Wire Minute Impulse (44th Minute)

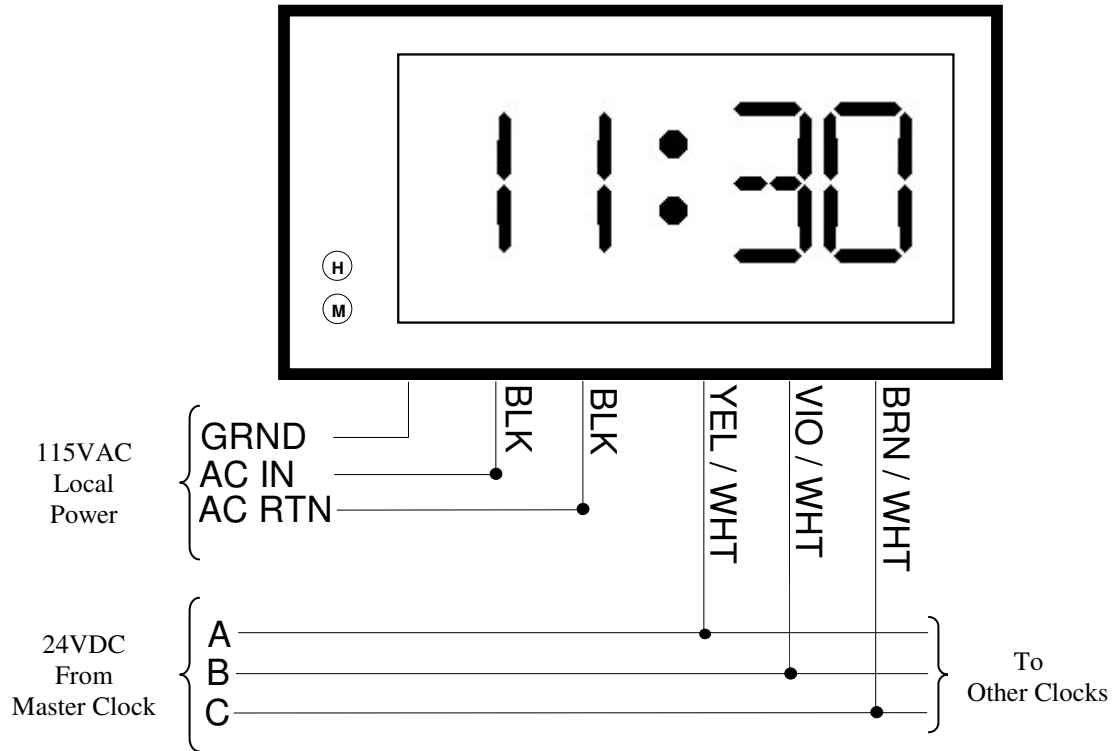

Clock must be set within 20 minutes of actual time for master to synchronize. Use of a 9Volt alkaline battery is recommended to avoid resets after power failures.

Set switches 1-5 of S1 as shown.

■ Indicates depressed side of switch

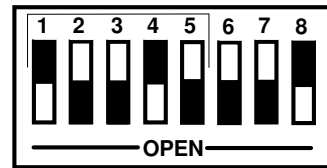

2-Wire Reverse Polarity Minute Impulse (59th Minute)

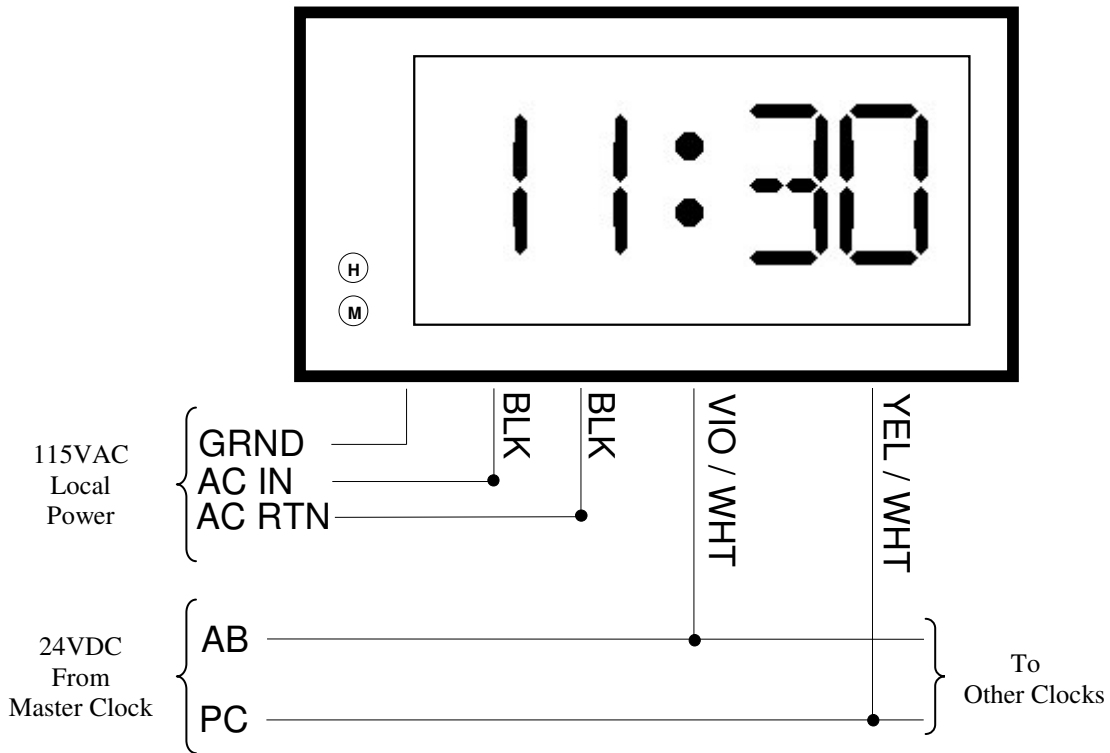

Clock must be set within 20 minutes of actual time for master to synchronize. Use of a 9Volt alkaline battery is recommended to avoid resets after power failures.

Set switches 1-5 of S1 as shown.

■ Indicates depressed side of switch

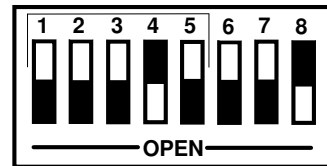

Appendix B - DDC2-RS-24 / DDC4-RS-24 Wiring

The DDC2-RS-24 and the DDC4-RS-24 allow for 24VAC supplied from the Master Clock or Power Supply to power it for normal operation. These models can be used in installations where local 115VAC power may not be available. When shipped, the DDC2-RS-24 and DDC4-RS-24 have an optional power transformer that allows for 24VAC operation.

The 24VAC power from the Master Clock or Power Supply should be connected to the two black wires leading from J1. (See figure 7 below for location of J1)

Correction wiring should be applied according to the secondary type selection as shown in Appendix A.

CAUTION: Applying any voltage higher than 24VAC to the input (two black leads from J1) WILL cause damage to the DDC2-RS-24 and DDC4-RS-24 clocks.

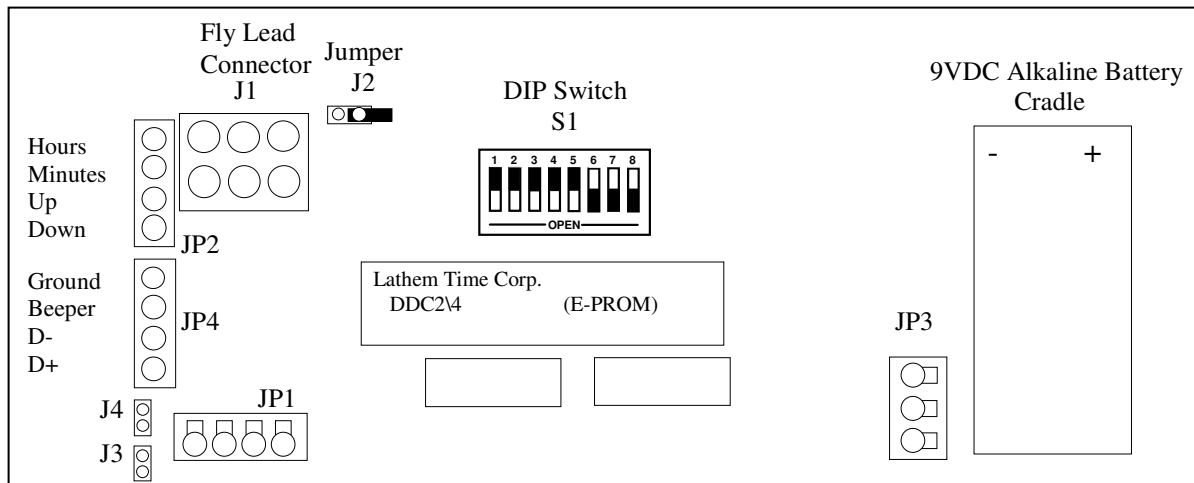
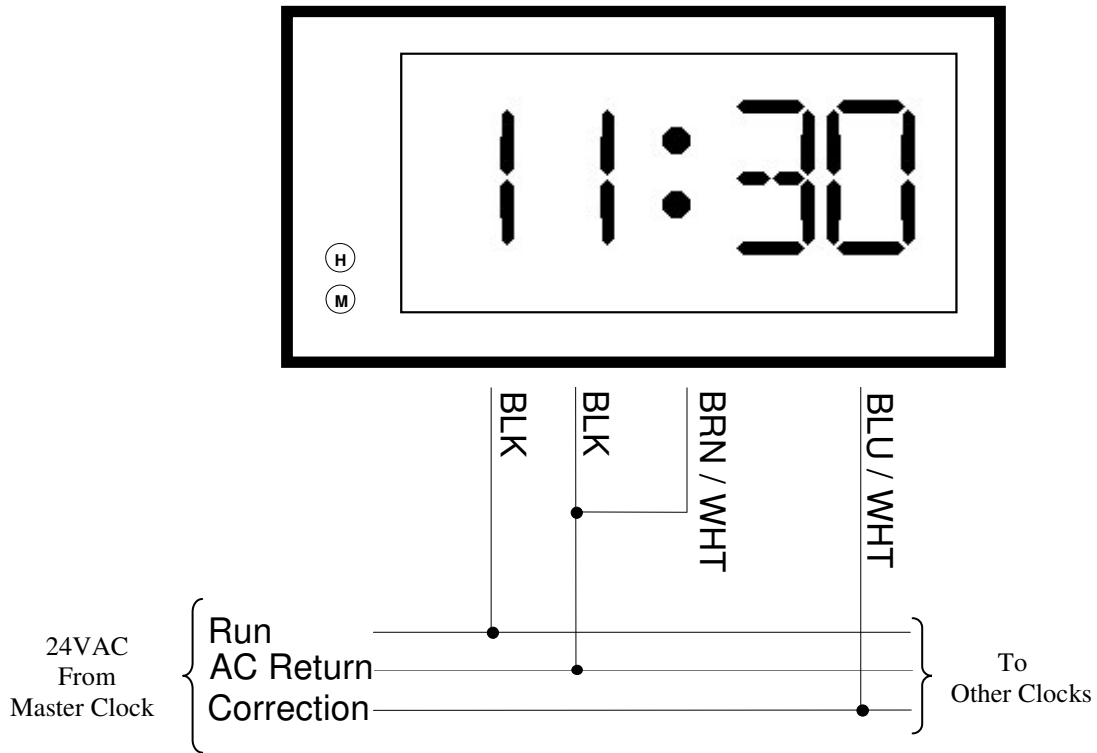

Figure 7

DDC2-RS-24 / DDC4-RS-24 Wiring



Set switches 1-5 of S1 as shown.

■ Indicates depressed side of switch

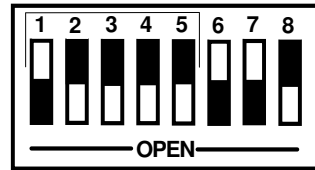

Appendix C - RS485 Wiring Diagrams

RS485 Data Format

The data string that sends the time to the DDC2 / DDC4 Series Wall Clocks is formatted in such a manner that a utility can be written to achieve time updates from a personal computer. The following table shows the layout and explains each character.

Data Format

0#112233445566777Z,CR

The data string is compiled of a total of 16 characters. These characters represent the following.

0	Address byte
#	Command for Time update
11	Hex for Seconds (01-59)
22	Hex for Minutes (00-59)
33	Hex for Hour (00-23)
44	Hex for Day of Week (Sunday = 0)
55	Hex for Month (01-12)
66	Hex for Date (01-31)
777	Hex for Year offset from 1984 (000-127)
Z	The Checksum (1's compliment of the mod-64 sum of all characters in the string except the CR and the Checksum)
CR	Carriage Return

Transfer of the above string must be done at 9600 Baud, 8 Data Bits, 1 Stop Bit and No Parity.

Requires the SWIFT-485 plus to convert the RS232 signal from the PC to RS485 to send data to the DDC Series Wall Clocks.

Note: Lathem does not offer a utility to perform this function. This information is supplied so that a 3rd party may create such a utility.

OMCII to DDC2-RS / 4-RS

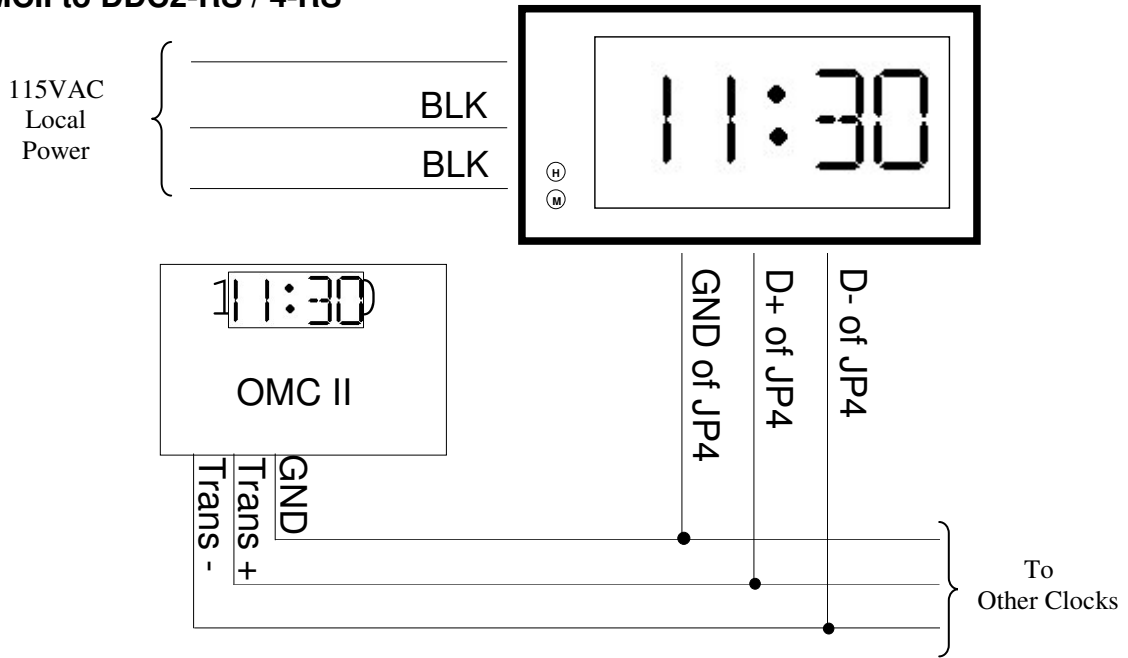

OMCII DB9 Female Plug

DDC2-RS / 4-RS - JP4 Connector

Pin	Signal	Signal	JP4 Connection
1	Transmit Data (-)	Transmit Data (-)	D-
2	Transmit Data (+)	Transmit Data (+)	D+
8	Signal Ground	Signal Ground	GND

Cable should be RS232 twisted pair / CAT3 or CAT5 type.
 Maximum distance to last DDC Clock is 4000 feet.
 Last DDC Clock must have jumper installed on position J2.
 See page 8 for details.

Set switches 1-5 of S1 as shown.

■ Indicates depressed side of switch

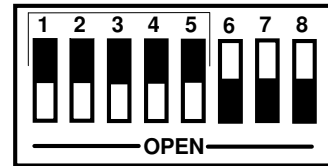

LTR0 to DDC2-RS / 4-RS

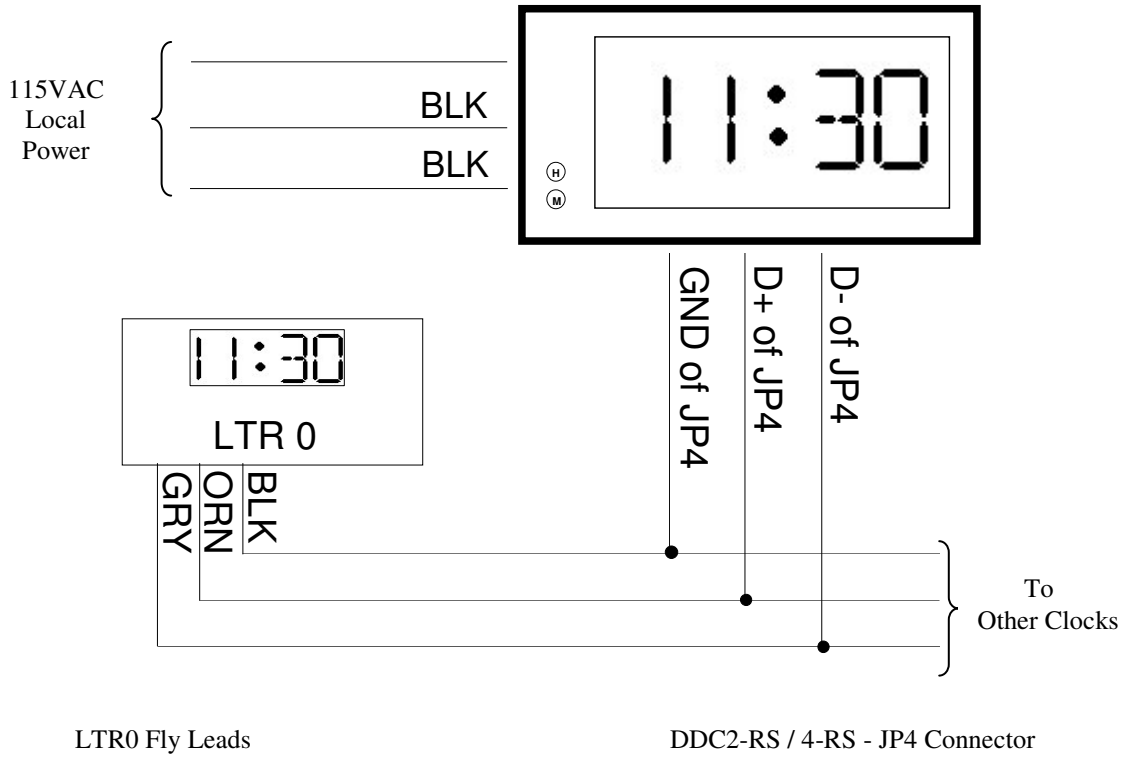

Wire	Signal		Signal	JP4 Connection
Gray	Transmit Data (-)		Transmit Data (-)	D-
Orange	Transmit Data (+)		Transmit Data (+)	D+
Black	Signal Ground		Signal Ground	GND

Cable should be RS232 twisted pair / CAT3 or CAT5 type.
 Maximum distance to last DDC Clock is 4000 feet.
 Last DDC Clock must have jumper installed on position J2.
 See page 8 for details.

Set switches 1-5 of S1 as shown.

■ Indicates depressed side of switch

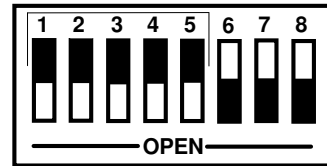

LTR4 / 8-512 to DDC2-RS / 4-RS

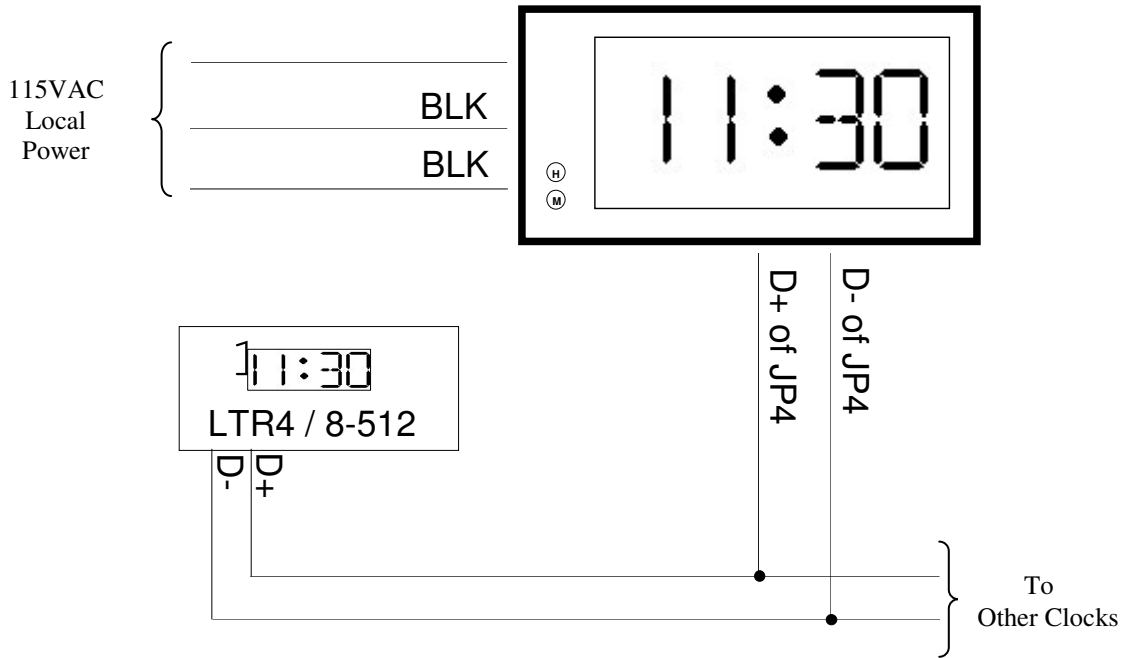

LTR4 / 8-512 Terminal Connections

DDC2-RS / 4-RS - JP4 Connector

Terminal #	Signal	Signal	JP4 Connection
9 (D-)	Transmit Data (-)	Transmit Data (-)	D-
8 (D+)	Transmit Data (+)	Transmit Data (+)	D+

Cable should be RS232 twisted pair / CAT3 or CAT5 type.
 Maximum distance to last DDC Clock is 4000 feet.
 Last DDC Clock must have jumper installed on position J2.
 See page 8 for details.

Set switches 1-5 of S1 as shown.

■ Indicates depressed side of switch

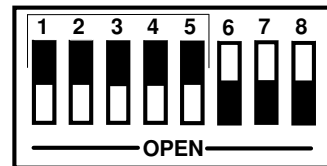

Appendix D - DDC-TC Timer Control Panel

Wiring

The DDC-TC can be connected to the DDC Series Wall Clock with a 6 conductor CAT3 or CAT5 network cable. The DDC-TC can be mounted up to 200 feet from the DDC Series Wall Clock. The DDC-TC comes with 6 wire nuts to connect the network cable to the 6 control wires mounted on the back of the DDC-TC. The 6 control wires include Up, Down, Hours, Minutes, Beeper and Ground. To wire the DDC-TC to the DDC Series Wall Clock locate JP2 and JP4 on the back of the DDC display panel (see figure 2, page 10), pass the wire through a knockout at both the DDC-TC double-gang box (not included), the DDC Wall Clock and follow the diagram below.

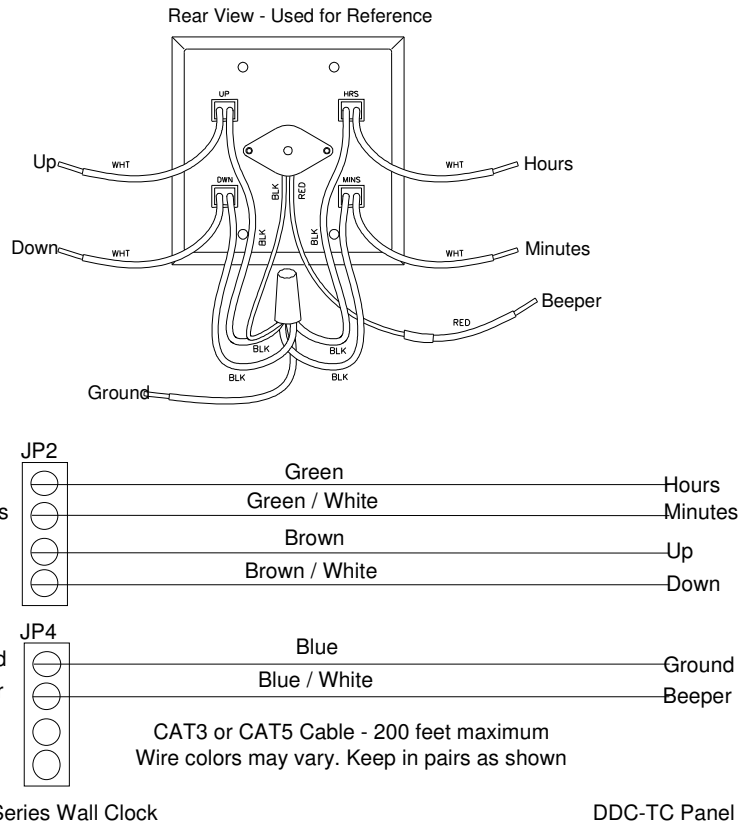

Installation

The DDC-TC mounts directly to a standard, double-gang wall box. (not included) Once the wiring has been attached, place the wires inside the double-gang wall box and mount the DDC-TC to the box with the four screws supplied with the DDC-TC by inserting them through the mounting holes and securing.

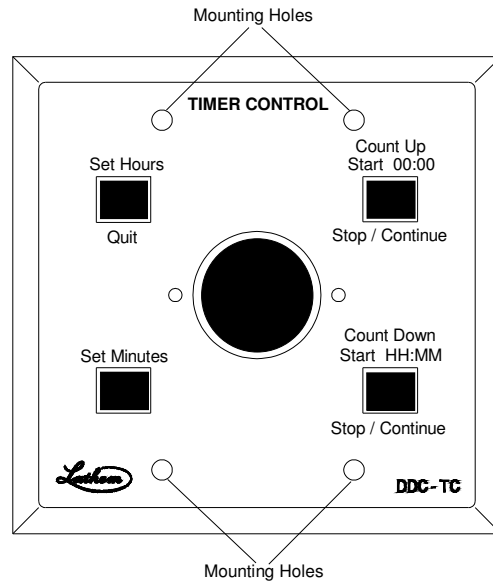

Operation

As a Count Up Timer

To start the count: press **Count Up**
To pause the count: press **Stop / Continue**
To continue the count: press **Stop / Continue**
To return to clock mode: press **Quit**

As a Count Down Timer

To set hours: press **Set Hours (default is 00:)**
To set minutes: press **Set Minutes (default is :00)**
To start the count: press **Count Down**
To pause the count: press **Stop / Continue**
To continue the count: press **Stop / Continue**
To return to clock mode: press **Quit**

Note: To pause and continue, press the corresponding Stop / Continue button that started the operation.

In the Count Down mode, when 00:00 is reached, an audible tone will sound and the display will return to clock mode.

When in Count Up or Count Down mode, when the time being counted is greater than 60 minutes the display will read HH:MM. When the time being counted reaches less than 60 minutes, the display will read MM:SS.

Appendix E - LTR-GPS Satellite Receiver / Clock Synchronizer

Lathem's LTR-GPS is a Global Positioning Satellite receiver using 12-channels to access the accurate date and time signal transmitted each second by 24 satellites in geosynchronous orbit around the globe.

The package includes an amplified GPS Antenna, which must be mounted out-doors or beneath a roof skylight, facing skyward. An integrated cable links the Antenna to the LTR-GPS Receiver Module, which should be mounted in-doors.

The Receiver Module verifies and reformats the received satellite data, and offers multiple synchronization protocol outputs:

The RS-485 Output can directly synchronize up to 31 Lathem time products, up to 4000ft away, over a single twisted-pair from a user-provided Cat-3 or Cat-5 cable. The length of cable and number of synchronized devices can be further increased using Lathem's "SWIFT485+" RS-485 Converter / Repeater. The supported products include:

LTR-0	Master Clock 1-Clock Ctl
DWA-S	Sonochron 1-Bell Ckt
LTR4-512	Master Clock 1-Clk + 2-Ckt
LTR8-512	Master Clock 1-Clk + 6-Ckt
LTR8-512M	Master Clock w/ Modem
DDC2-RS	2" Digital Wall Clock 115v
DDC2-RS-24	2" Digital Wall Clock 24v
DDC4-RS	4" Digital Wall Clock 115v
DDC4-RS-24	4" Digital Wall Clock 24v

An included RS-232 interface provides a periodic "Time Stamp" transmission, "MM-DD-YYYY HH:MM:SS cr", for use by computing systems having custom software to incorporate accurate date and time records in their applications: 9600,N,8,1. Use of this option requires Lathem cable, Part No. SAE0370, to be ordered separately.

Simple DIP-Switch set-up enables the installer to specify local Time Zone, Daylight Savings Time corrections, and output formats. An LED indicator shows Signal Reception / Protocol Mode.

The LTR-GPS may receive its power from an LTRx-512-series Master Clock, using 2nd cable pair, if the distance is less than 200ft; else, power is provided locally by a 9vAC Power Adapter.

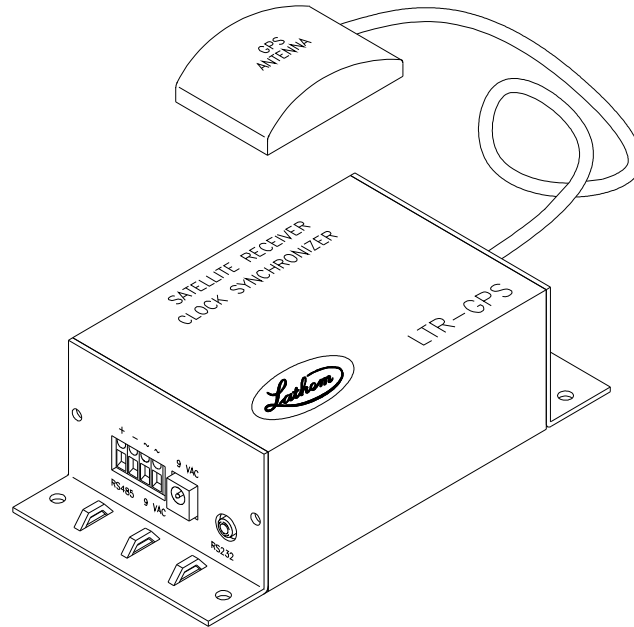

The LTR-GPS package includes:

- LTR-GPS Satellite Synchronizer
- 115vAC, 2.7w, 50/60Hz Power Adapter
- Active GPS Antenna with 25ft. Cable
- Antenna Mounting Bracket and Hardware
- Installation and Set-Up Guide

Separately, from Lathem, for Installer convenience:

- GPS-INSTALL-TOOLS: Battery / Beeper assemblies aid in Antenna positioning

LTR-GPS Specifications:

- Size / Weight 3.25" x 2" x 6.6" / 1 lb.
- Power: 6-12vAC/DC, 300mA (max)
- Certificates: FCC Part-15, ICES003

Connecting to a Lathem DDC2-RS or DDC4-RS Digital Clock

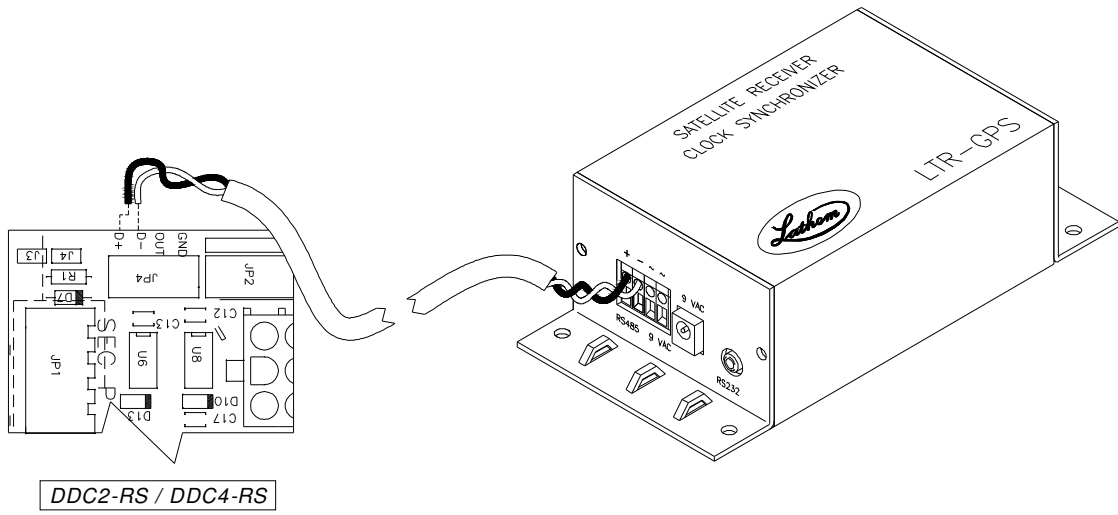

Appendix F - Specifications

Dimensions	DDC2	4 7/8" H X 10 1/4" W X 3 1/8" D 12.4 cm H X 26.2 cm W X 7.9 cm D
	DDC4	6 3/4" H X 15 1/2" W X 3 1/8" D 17.1 cm H X 39 cm W X 7.9 cm D
Weight	DDC2	3.2 lbs (1.451 kg)
	DDC4	9 lbs. (4.086 kg)
Display	DDC2	1 3/4-Inch Red 7 Segment LED
	DDC4	3 3/4-Inch Red 7 Segment LED
Housing	DDC2	Extruded aluminum main case with black textured paint, red lexan panel; steel end caps with black textured paint.
	DDC4	Extruded aluminum main case with black textured paint, steel front panel with black textured paint; molded plastic end caps with black texture.
Line Power	DDC2 / DDC4	115VAC, 80mA typical 220VAC, 80mA typical (optional)
	DDC2-RS-24 / DDC4-RS-24	24VAC, 400mA typical
Standby Power	DDC2 / DDC4	9VDC, 1.2mA Alkaline Battery (not included)
Environment	DDC2 / DDC4	32° to 150° F (0° to 65° C) 95% Relative Humidity (non-condensing)
Correction Signal		115VAC, 6.5mA 24VDC, 16mA 48VDC, 40mA 60VDC, 56mA 24VAC, 6.5mA
Mounting	DDC2 / DDC4	Wall (surface) Single Gang Box (surface) Double Face (wall or ceiling) (optional)

Appendix G - Warranty

Limited One-Year Limited Warranty

Lathem warrants the hardware products described in this guide against defects in material and workmanship for a period of **one year** from date of original purchase from Lathem or from an authorized Lathem reseller. The conditions of this warranty and the extent of the responsibility of Lathem Time Corporation ("Lathem") under this warranty are listed below.

1. This warranty will become void when service performed by anyone other than an approved Lathem warranty service dealer results in damage to the product.
2. This warranty does not apply to any product which has been subject to abuse, neglect, or accident, or which has had the serial number altered or removed, or which has been connected, installed, adjusted, or repaired other than in accordance with instructions furnished by Lathem.
3. This warranty does not cover dealer labor cost for removing and reinstalling the machine for repair, or any expendable parts that are readily replaced due to normal use.
4. The sole responsibility of Lathem under this warranty shall be limited to repair of this product, or replacement thereof, at the sole discretion of Lathem.
5. If it becomes necessary to send the product or any defective part to Lathem or any authorized service dealer, the product must be shipped in its original carton or equivalent, fully insured with shipping charges prepaid. Lathem will not assume any responsibility for any loss or damage incurred in shipping.
6. **WARRANTY DISCLAIMER AND LIMITATION OF LIABILITY:** Except only the limited express warranty set forth above, the products are sold with no expressed or implied warranties of any kind, and the implied warranties of merchantability and fitness for a particular purpose are hereby expressly disclaimed. No warranties are given with respect to products purchased other than from Lathem or an authorized Lathem reseller and any such products are purchased "as is, with all faults." In no event will Lathem be liable for any direct, indirect, special, incidental or consequential damages arising out of or in connection with the delivery, use or inability to use, or performance of this product. In the event any limited remedy given herein shall be deemed to have failed of its essential purpose, Lathem's maximum liability shall be to refund the purchase price upon return of the product.
7. Proof of date of purchase from Lathem or an authorized Lathem reseller is required for warranty service on this product.
8. This Warranty grants specific legal rights. Additional legal rights, which may vary by locale, may also apply.
9. Should any difficulties arise with the performance of this product during warranty, or with any Lathem authorized service centers, contact Lathem Time at the address below.

Lathem Time
200 Selig Drive, SW, Atlanta, GA 30336
404-691-0405

www.lathem.com

Copyright © 2003 Lathem Time Corporation. All rights reserved.

Free Manuals Download Website

<http://myh66.com>

<http://usermanuals.us>

<http://www.somanuals.com>

<http://www.4manuals.cc>

<http://www.manual-lib.com>

<http://www.404manual.com>

<http://www.luxmanual.com>

<http://aubethermostatmanual.com>

Golf course search by state

<http://golfingnear.com>

Email search by domain

<http://emailbydomain.com>

Auto manuals search

<http://auto.somanuals.com>

TV manuals search

<http://tv.somanuals.com>