

# DWA-4000



## OPERATIONS MANUAL



*Keeping Americans On Time Since 1919*

---

## SPECIFICATIONS

### PHYSICAL

Height:	11 3/8 inches
Width:	9 1/2 inches
Depth:	6 inches
Weight:	16 1/2 lbs. (18 lbs. shipping wgt.)
Case:	Parkerized, Wrinkle Finish
Color:	Gray
Power Cord:	6 feet, grounded

### COMPONENTS

Key Lock:	Chrome finished
Card Receiver:	Stainless steel
Ribbon:	Two color (red/blue)
Timing Motor:	1 RPM, K342 type
Signal Relay:	Form A (10Amps) Dry Contact

### FEATURES

Display:	4 Digit, 7 Segment LED (Red)
Registration:	Automatic
	Touch Plate (Optional)

### POWER REQUIREMENTS

Voltage:	115 VAC (220 VAC Optional)
Current:	9 Amp. Max. Intermittent for 115 VAC
	4 1/2 Amp. Max. Intermittent for 220 VAC
Frequency:	60 Hz (50Hz Optional)
Battery:	9 V Non-rechargeable (supplied by customer)

---

**POSSIBLE SHOCK HAZARD EXISTS WHEN CASE COVER IS REMOVED AND AC POWER IS CONNECTED. EXERCISE CAUTION WHEN SETTING TYPE SECTIONS AND TIME DISPLAYS. BE CERTAIN TO AVOID CONTACTING FOREIGN OBJECTS WITH CIRCUIT BOARDS.**

---

This document is a confidential proprietary document solely for the use of Lathem customers. The information contained herein may not be reproduced on any media for any purpose without the written permission of Lathem Time Corporation.

© Copyright 1992, Lathem Time Corporation

## Table of Contents

INTRODUCTION .....	2
REGISTRATION STYLES .....	2
REFERENCE FIGURES .....	3
INSTALLATION INSTRUCTIONS .....	4
KEYPAD LAYOUT AND DESCRIPTION OF LED DISPLAY .....	5
FUNCTIONS OF THE KEYPAD .....	6
GETTING STARTED .....	7
To Choose The Time Format .....	7
SETTING THE TYPE SECTION .....	7
Raise And Set The Type Section .....	7
Dial of Decimal Equivalents .....	8
SETTING THE DIGITAL FACE .....	9
To Set the Current Time .....	9
To Set the Current Day .....	9
TO PROGRAM SIGNAL EVENTS .....	10
To Establish Signal Length .....	10
To Establish Signal Events .....	10
To Delete Signals .....	11
To Sound a Signal That Has Not Been Programmed .....	11
To Enable or Disable Signals Globally .....	11
To Review Signals .....	11
POWER FAILURE .....	12
TO TEST THE BATTERY .....	12
MAINTENANCE .....	13
How To Change A Ribbon .....	13
How To Change A Type Section .....	13
How To Change A Motor .....	14
INTERNAL WIRING DIAGRAM .....	15
ONE YEAR LIMITED WARRANTY .....	16
USER WORK SHEET TO ASSIST IN PROGRAMMING .....	Back Cover
WARRANTY CARD .....	Back Cover

**WARNING:** This equipment generates, uses, and can radiate radio frequency energy and, if not installed and used in accordance with the instruction manual, may cause interference to radio communications. It has been tested and found to comply with the limits for a Class A computing device pursuant to Subpart J of part 15 of FCC Rules, which are designed to provide reasonable protection against such interference when operated in a commercial environment. Operations of the equipment in a residential area is likely to cause interference, in which case, the user, at his own expense, will be required to take whatever measures may be required to correct the interference.

## INTRODUCTION

The Lathem 4000 Series time recorders are considered "standard" by thousands of businesses and institutions because of their low initial cost and years of proven, trouble-free operation. Many options are available with models to fit most business needs for payroll and job timekeeping. The DWA-4000 series features touch plate or automatic registration, right or left margin imprint, self reversing ribbon, digital time display, coined steel type wheels, and easy installation. A particularly useful feature of the DWA-4000 series is a keypad-programmable signal relay, capable of ringing bells (or other signal devices) at selected times as well as inhibiting their operation when not desired.

Read all directions carefully before operating or maintaining the DWA-4000. Should it be necessary to return the unit, retain the original packing materials for shipping. This operations manual is designed to provide basic operating instructions. Minor maintenance and adjustments can also be performed easily and effectively by referring to these instructions. For service beyond the scope of this manual, contact the dealer from whom the equipment was purchased or Lathem Time Company.

## REGISTRATION STYLES

A wide selection of registrations is available to suit the needs of any business, including day-of-week or month-and-date; standard hours (1-12, 1-12) or continental hours (0-23); and minutes (00-59), tenths (.0-.9), or hundredths (00-98).

<u>Auto- matic</u>	<u>Touch Plate</u>	<u>Will Register</u>
4001	4051	Month and Date, Standard Hours (1-12, 1-12), Minutes (0-59)
4002	4052	Month and Date, Standard Hours (1-12, 1-12), Tenths (.0-.9)
4003	4053	Month and Date, Standard Hours (1-12, 1-12), Hundredths (00-98)
4004	4054	Month and Date, Continental Hours (0-23), Minutes (0-59)
4005	4055	Month and Date, Continental Hours (0-23), Tenths (.0-.9)
4006	4056	Month and Date, Continental Hours (0-23), Hundredths (00-98)

Add 20 to model number for day of week registration (4001 + 20 = 4021).

4021	4071	Day of Week, Standard Hours (1-12, 1-12), Minutes (0-59)
4022	4072	Day of Week, Standard Hours (1-12, 1-12), Tenths (.0-.9)
4023	4073	Day of Week, Standard Hours (1-12, 1-12), Hundredths (00-98)
4024	4074	Day of Week, Continental Hours (0-23), Minutes (0-59)
4025	4075	Day of Week, Continental Hours (0-23), Tenths (.0-.9)
4026	4076	Day of Week, Continental Hours (0-23), Hundredths (00-98)

For left hand print, add ten to the model number (4001 + 10 = 4011). For year wheel add -5 as a suffix (4051-5). Year wheels are available on models with month and date only. Check year wheels periodically for expiration date. Consult dealer in advance to prevent interruption of service.

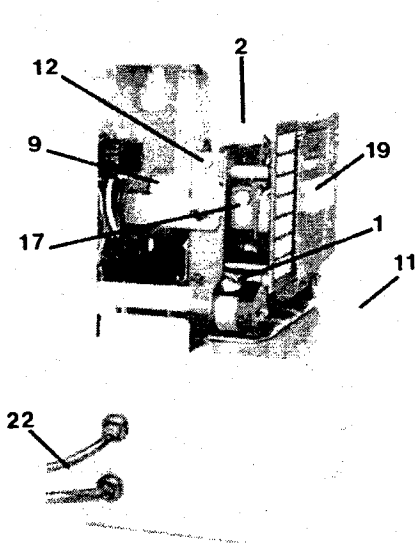
**REFERENCE FIGURES**

FIGURE 1

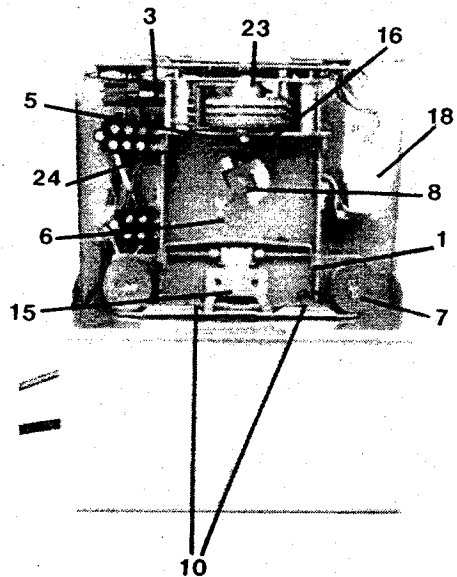


FIGURE 2

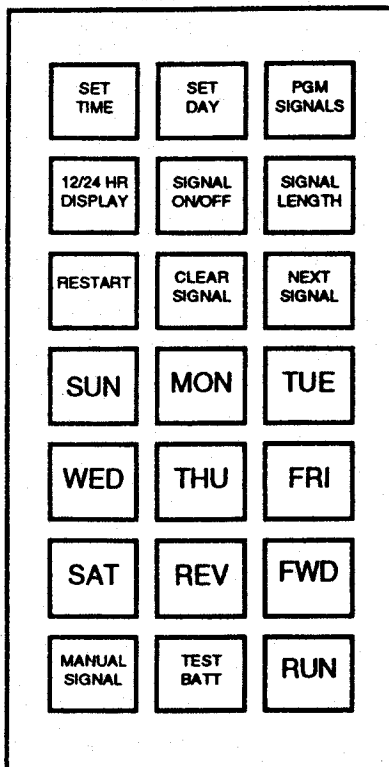
The following reference points are indicated on Figures 1,2,3, and 4:

- |    |                              |    |                                 |
|----|------------------------------|----|---------------------------------|
| 1  | Type Section Unlocking Latch | 14 | Terminal Block #2 (TB2 / Upper) |
| 2  | Type Section Open Latch      | 15 | Ribbon Shield                   |
| 3  | Type Wheel Overthrow Lever   | 16 | Main Drive Wheel                |
| 4  | Data Entry Keypad            | 17 | Battery                         |
| 5  | Upper Motor Mounting Screw   | 18 | Electrical Connector            |
| 6  | Lower Motor Mounting Screw   | 19 | Digital Clock Display           |
| 7  | Ribbon Spindles              | 20 | PM Indicator LED                |
| 8  | Motor Drive Clutch           | 21 | Program On/Off Status LED       |
| 9  | Motor                        | 22 | Bell Cord                       |
| 10 | Ribbon Reverse Fingers       | 23 | Center Alignment Position       |
| 11 | Card Receiver                | 24 | Hinge Pin                       |
| 12 | Type Section Retaining Clip  | 25 | Hinge Pin Socket                |
| 13 | Terminal Block #1 (Lower)    | 26 | Motor Wires                     |



## SETTING INSTRUCTIONS FOR DWA-4000 SERIES

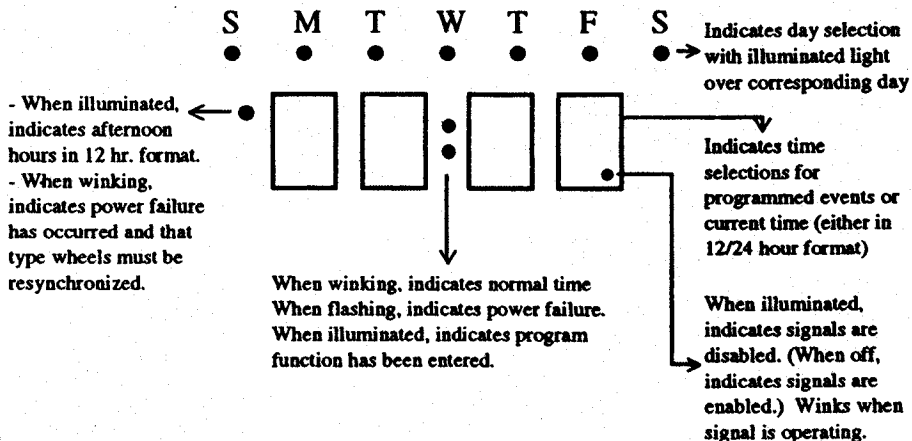
### KEYPAD



The type wheels and the digital clock function independently of one another. Setting the digital clock does not set the type wheels. Similarly, setting the type wheels does not set the digital clock. Each assembly must be set individually and synchronized.

No security code is required to access program functions since the keypad is behind the locked cover. Unlock and remove the case cover.

### LED DISPLAY



## FUNCTIONS OF THE KEYPAD

SET TIME	Initiates program to set time
SET DAY	Initiates program to set day of week
PGM SIGNALS	Initiates program to set signal schedule
12/24 HR DISPLAY	Allows choice of standard or continental hour format
SIGNAL ON/OFF	Allows enabling or disabling of programmed events signals
SIGNAL LENGTH	Allows choice of duration of signal events
RESTART	Restarts the clock after a display lock-up condition, leaving all schedules intact
CLEAR SIGNAL	Deletes previously programmed event; also stops signal currently in progress
NEXT SIGNAL	Displays programmed signals from the current time forward
SUN	<div style="border: 1px solid black; display: inline-block; padding: 2px 10px;">MON</div> , ETC. Allows identification of current day of the week or day(s) of the week for programmed signal events
REV	Allows count-down in setting current time, times for programmed signal events, or duration of signals
FWD	Allows count-up in setting current time, times for programmed signal events, or duration of signals
MANUAL SIGNAL	Manually activates the signalling device
TEST BATT	Displays the battery's status ("Good" or "Lo")
RUN	Completes program sequence and returns clock to normal operation




## GETTING STARTED

Before proceeding, you need to know the "registration time format" of your time recorder. The fourth digit in the model number indicates this format. **EXAMPLE:** Since the fourth digit in the model number 4054 is a "4", it will print with 0-59 minutes and 0-23 hours, along with month and date (See Page 2).

1. Plug the clock into the wall socket.
2. Install 9 V alkaline battery (not supplied).
3. Choose the time format desired. (Below)
4. Set the type section. (Below)
5. Set the digital face. (Page 9)
6. Program the signals. (Page 10)
7. **THAT'S IT!** You're ready to go.

### TO CHOOSE THE TIME FORMAT

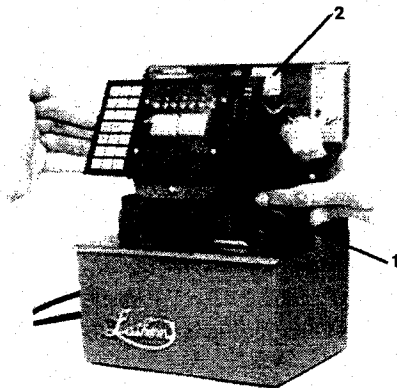
The clock defaults to the 12 hour format and will appear on the display as 12:00, if the 12 hour format is desired, no action is required. If 24 hour format is desired:

1. Press  The display should read 00:00. The key toggles between the two formats. To go back to 12 hour format, simply press this key again.

## SETTING THE TYPE SECTION

### RAISE AND SET THE TYPE SECTION

1. Unlock the case cover and remove it by sliding it forward, away from the clock.
2. Locate these color-coded components:
  - unlocking latch - blue (Fig. 1, 1)
  - overthrow lever - red (Fig. 1, 3)
  - open latch - white (Fig. 1, 2)
3. Press the blue unlocking latch and raise the type section to a locked position, as shown in Figure 5.
4. Press the red overthrow lever back until it "clicks". The wheels are now unlocked and should turn freely.



**FIGURE 5**

NOTE: If your machine records in 1-12 hours, the PM hours are underlined>. AM hours are not underlined. Set time to the proper hour of the day to avoid errors such as setting the day wheel to the next day at noon rather than midnight.

5. Use a pointed object to rotate each wheel until the correct time and day are vertically aligned at the center position, as shown (Fig. 6, 23). If you are using tenths (models with 4th digit of 2 or 5), go to the section "Setting Decimal Wheel with Tenths". If you are using hundredths or 0-23 hours, refer to the Dial of Decimal Equivalents in Figure 7 to determine the correct setting.
6. Rotate the main drive wheel to advance the wheels for any time lost during this setting procedure.
7. Release the white open latch by pressing left. Gently lower the type section.
8. Press firmly against face of the type section to lock into the closed position.

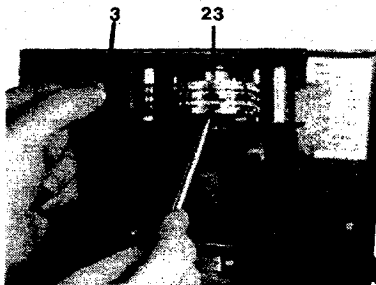


FIGURE 6

### DIAL OF DECIMAL EQUIVALENTS

The dial in Figure 7 shows the tenths and hundredths setting for each minute. The small inner circle represents minutes, the middle circle represents tenths, and the outer circle represents hundredths. For example:

45 minutes = .7 tenths = .75 hundredths.

#### Setting Decimal Wheel with Tenths

NOTE: Use only for recorders printing in tenths (models with a 4th digit of "2" or "5")

1. Rotate Tenths Wheel and set it at "9". A wheel is set when the desired number is in line with 6:00 on the clock face.
  2. Rotate Main Drive Wheel (Fig. 2, 16) until the Tenths Wheel clicks over from "9" to "0".
  3. Rotate Hour Wheel to set current hour.
  4. Set correct minutes by rotating Main Drive Wheel one time each minute.
- For example, at 10:05, rotate 5 times = 5 clicks = 5 minutes past ten o'clock.

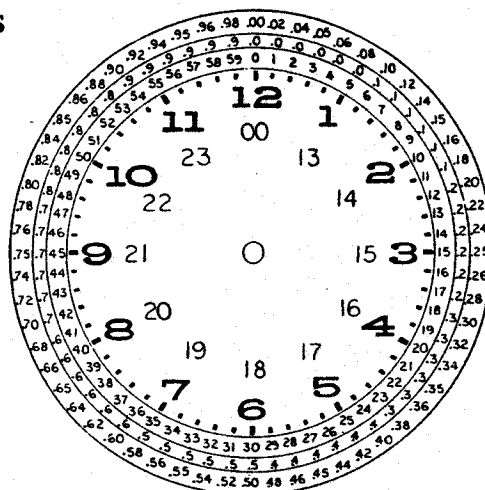






FIGURE 7

## SETTING THE DIGITAL FACE





### TO SET THE CURRENT TIME

The clock defaults to 12 midnight.

1. Press 
2. Use a piece of paper and make a registration. Remember to set the digital face to minutes regardless of the print format of the Type Section (minutes, tenths, hundredths).
3. Press  or  To advance or reverse numerals on Hr:Min face until time shown is one minute ahead of the time shown on the registration. Minutes are advanced or reversed first, followed by the hour.
4. Listen for the wheels in the type section to click forward. When this happens, immediately
5. Press  This will synchronize the type section with the digital display. The time is now set. Make another registration to verify that the process was completed successfully.

### TO SET THE CURRENT DAY

The clock defaults to Sunday

1. Press 
2. Press  ,  , ETC. Corresponding light over chosen day will illuminate.
3. Press  The day is set.

## TO PROGRAM SIGNAL EVENTS

The user may define the occurrence, duration, and frequency of signal events. Up to 32 events, each consisting of a time and days of the week, may be assigned. The same time on multiple days is considered one event. During an attempt to program more than 32 events, the display, "Full", appears, and the attempt is aborted.

### TO ESTABLISH SIGNAL LENGTH

1. Press SIGNAL  
LENGTH The duration default is 5 seconds.
2. Press FWD or REV to alter the duration of the signal until the desired duration is reached.  
Duration possibilities range from 01 to 99 seconds.
3. Press RUN The duration is set.





### TO ESTABLISH SIGNAL EVENTS

1. Press PGM  
SIGNALS The clock defaults to 12:00 midnight and will display consistent with the time format you previously selected. The colon will be illuminated and fixed, indicating the clock is in a programming mode.
2. Press NEXT  
SIGNAL to verify that the desired signal does not exist or to quickly advance through the schedule to the event nearest the event you wish to add.
3. Press FWD or REV To advance or reverse numerals on Hr:Min face until desired time is displayed. Minutes are advanced or reversed first, followed by the hour.
4. Press SUN , MON , ETC. To which corresponding signal applies. Light over the chosen day(s) illuminates.


Other events may be programmed by repeating steps 2 through 4. When all programs have been entered:

5. Press RUN The signal(s) has been added.

**TO DELETE SIGNALS**

1. Press  As many times as necessary to reach the identified signal to be deleted. The signals scroll from current time forward.
2. Press  to delete signal. All day LED's extinguish.
3. Press  The signal has been deleted.
4. Press 

**TO SOUND A SIGNAL THAT HAS NOT BEEN PROGRAMMED**

1. Press  to sound the signal. The signal will sound as long as the key is depressed.

This signal is independent of the program signals function and works in either the enabled or disabled mode. When the manual signal is operated, the disable light at the lower right of the minute display will flash.


**TO ENABLE OR DISABLE SIGNALS GLOBALLY**

To toggle between all programmed signals on or all programmed signals off:

1. Press 

To determine whether the programmed signals are on or off, look to the right of the minute display. If a light is illuminated, all signals are off and no signal will sound. If the light is not visible, all signals are on and will occur as programmed.


**TO REVIEW SIGNALS**

1. Press  to review all signals which have been installed. If no signal has been programmed, the display remains the same current time. Review starts from current time.

## **POWER FAILURE**

The clock's display and type section keep time according to line frequency (typically 60 Hz). During power failure, the unit automatically switches to an internal quartz crystal to maintain time. A 9-volt non-rechargeable battery maintains display time and memory for up to 15 accumulated days. When power is interrupted, the digital display disappears with the exception of the flashing colon.

When power is restored, the display indicates the correct time and day, and all programmed signals are intact. If the PM indicator is flashing when power is restored the type wheels may need to be reset and synchronized with the time display. To verify whether or not the type wheels should be re-synchronized with the display:

1. Press  To clear the flashing PM indicator and set the clock in normal mode.
2. Use a piece of paper and make a registration on it by inserting it into the card receiver.
3. Compare the registration with what is shown on the display. If they match, there is no need for further action. If they don't match:
4. Go to "GETTING STARTED" on page 7 and follow the steps for "SETTING THE TYPE SECTION" and "SETTING THE DIGITAL FACE".

## **TO TEST THE BATTERY**

1. Press  The display indicates "Good" or "Lo"

Since the battery is non-rechargeable, it should be replaced when the display indicates "Lo".

## MAINTENANCE

### HOW TO CHANGE A RIBBON

Lathem time recorders have self-reversing ribbons. With normal use, a ribbon should last for many months or even years...and when the time comes, it is easy to change.

1. Remove the top cover and raise type section (see "Raise the type section on page 7.)
2. Remove the cotter pins (Fig. 8, 7) that retain the ribbon spools and slide off old spools.
3. Lift ribbon shield (Fig. 8, 15)—use pencil to support in up position.
4. Remove ribbon and replace with new Lathem ribbon. Make sure the ribbon feeds from bottom of spools and runs BETWEEN reversing fingers (Fig. 8, 10), the red side aligned with date wheel(s).
5. Install cotter pins, remove pencil, and lower type section into place.

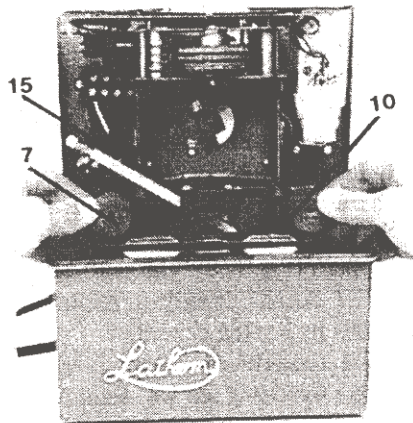


FIGURE 8

### HOW TO CHANGE A TYPE SECTION

If your type section needs servicing, you can easily remove and replace it with a spare, without sending the entire machine for service. Here's how:

1. Remove the top cover.
2. Remove type section retaining ring (Fig. 1, 12).
3. Unplug connectors (Fig. 9, 18).
4. Lift type section slightly and move it to the right to release hinge pins (Fig. 9, 24) from their socket (Fig. 9, 25). Unit will lift out (Fig. 9).

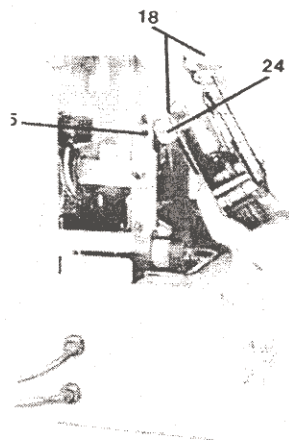


FIGURE 9

**HOW TO CHANGE A MOTOR**

1. Remove top cover.
2. Unplug cord from wall outlet.
3. Remove type section from main frame (see "How to Change A Type Section", Page 13).
4. Disconnect motor wire leads by turning each screw 1/4 of a turn counterclockwise (Fig. 10, 26).
5. Remove the motor drive clutch from its shaft (Fig. 2, 8). The shaft has LEFT HAND threads — remove clutch by turning clockwise.
6. Hold motorbracket and loosen motor mounting screws. Remove and retain screws and bracket from old motor.
7. Install new motor.
8. Install motor clutch on new motor.

Turn counterclockwise to tighten. **DO NOT OVERTIGHTEN OR BEND — YOU MAY DAMAGE INTERNAL MOTOR GEARS.**

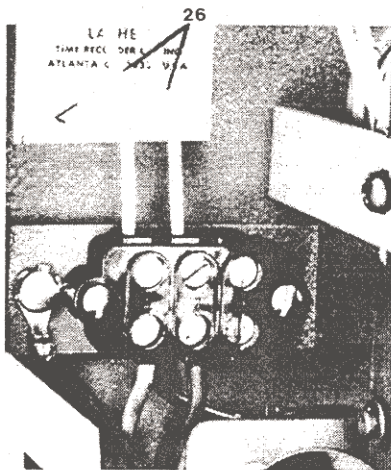
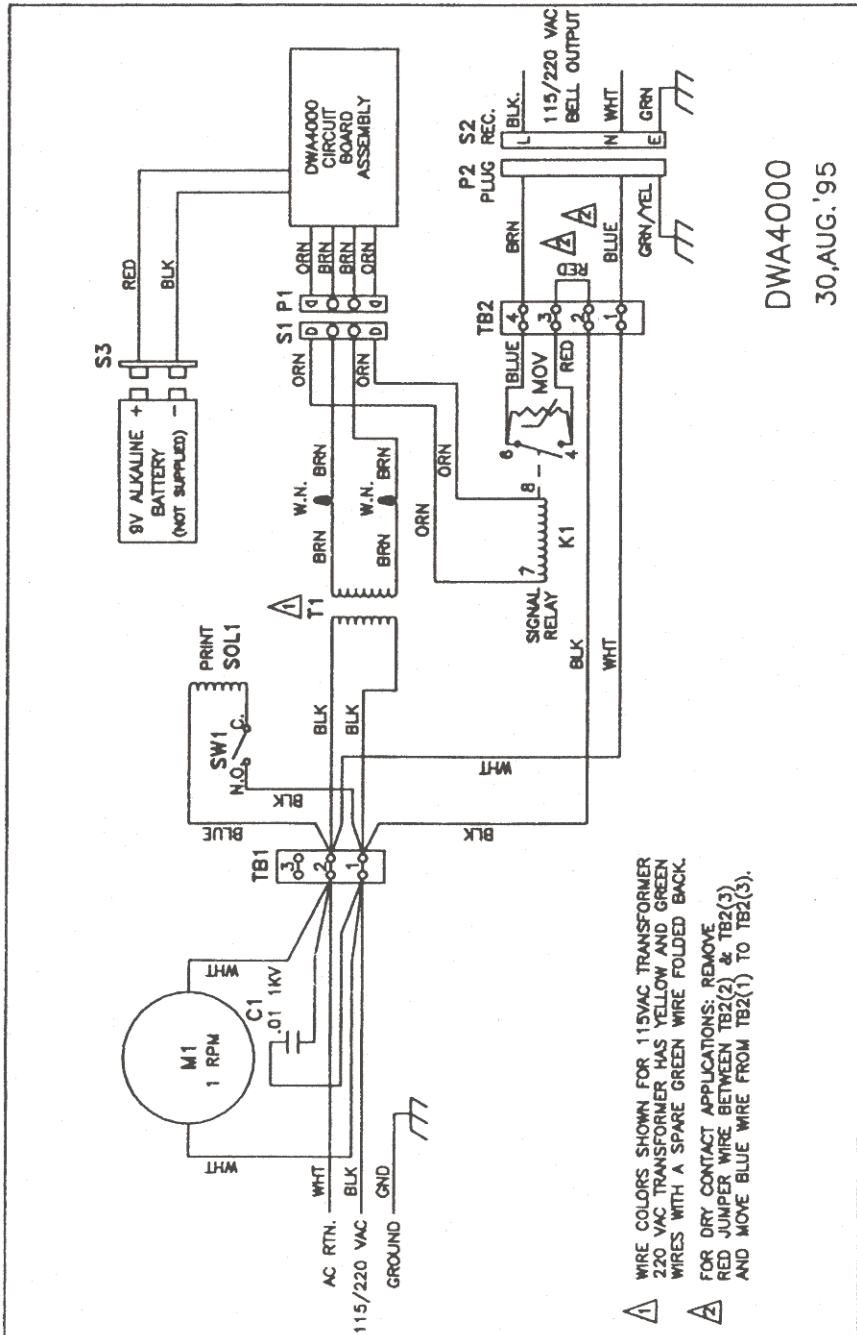


FIGURE 10



**INTERNAL WIRING DIAGRAM**



DWA4000

30,AUG.'95

# Operation Manual Addendum

## DWA-4000

---

To improve the performance and reliability of this product, we have replaced the previous 10 AMP Dry Contact Relay, with a 10 AMP Solid State Relay. The new Solid State Relay only operates with 24 - 240 VAC external devices (bells, horns, etc.). External DC powered devices should not be connected to this unit.

Due to this change, please note the following corrections to this manual:

- Inside Cover*      Signal Relay is no longer a **Form A (10 AMP) Dry Contact**, instead it should read **10 AMP Solid State 24 - 240 VAC Only**.
- Page 4*              Under the **Typical Wiring Configurations** section, the wiring diagram labeled **USING SIGNAL RELAY AS A DRY CONTACT TO SWITCH AUDIO** is no longer valid. Please disregard.
- Page 15*             The **INTERNAL WIRING DIAGRAM** is no longer valid. Please use the new diagram printed on the **back of this Addendum** instead.

Form: A-OM409803



**ONE YEAR LIMITED WARRANTY**

This Lathem product is warranted against defects in material and workmanship for a period of one year from date of original purchase. The conditions of this warranty and the extent of the responsibility of Lathem Time Corporation ("Lathem") under this warranty are as follows:

1. This warranty will become void when service performed by anyone other than an approved Lathem warranty service dealer results in damage to the product.
2. This warranty does not apply to any product which has been subject to abuse, neglect, or accident, or which has had the serial number altered or removed, or which has been connected, installed, adjusted, or repaired other than in accordance with instructions furnished by Lathem.
3. This warranty does not cover dealer labor cost for removing and reinstalling the machine for repair, or any expendable parts that are readily replaced due to normal use.
4. The sole responsibility of Lathem under this warranty shall be limited to repair of this product, or replacement thereof, at the sole discretion of Lathem.
5. If it becomes necessary to send the product or any defective part to Lathem or any authorized service dealer, the product must be shipped in its original carton or equivalent, fully insured with shipping charges prepaid. Lathem will not assume any responsibility for any loss or damage incurred in shipping.
6. **WARRANTY DISCLAIMER: Limitation of Liability.** Except in only the limited express warranty set forth above, there are no expressed or implied warranties of merchantability and fitness for a particular purpose. In no event will Lathem be liable for any direct, special, or consequential damages arising out of or in connection with the delivery, use or inability to use, or performance of this product.
7. Proof of date of purchase is required for warranty service on this product.
8. This Warranty grants specific legal rights. Additional legal rights, which may vary by locale, may also apply.
9. Should any difficulties arise with the performance of this product during warranty, or with any Lathem authorized service centers, contact:

LATHEM TIME CORPORATION  
200 Selig Drive, S.W.  
Atlanta, GA USA 30378  
404-691-0400

## Free Manuals Download Website

<http://myh66.com>

<http://usermanuals.us>

<http://www.somanuals.com>

<http://www.4manuals.cc>

<http://www.manual-lib.com>

<http://www.404manual.com>

<http://www.luxmanual.com>

<http://aubethermostatmanual.com>

Golf course search by state

<http://golfingnear.com>

Email search by domain

<http://emailbydomain.com>

Auto manuals search

<http://auto.somanuals.com>

TV manuals search

<http://tv.somanuals.com>