

OWNER'S MANUAL

LEGACY®

COMPACT DISC PLAYER WITH
AUXILIARY INPUT AND
SUPER POWER OUTPUT
FACE DETACHABLE PANEL
FM-AM FM-MPX RADIO RECEIVER
WITH READABLE MP3 SONG

MODEL: **LCD95MP3**

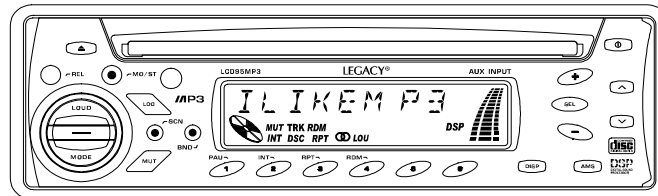

P / N : 570-C22652-03

LOCATION OF CONTROLS

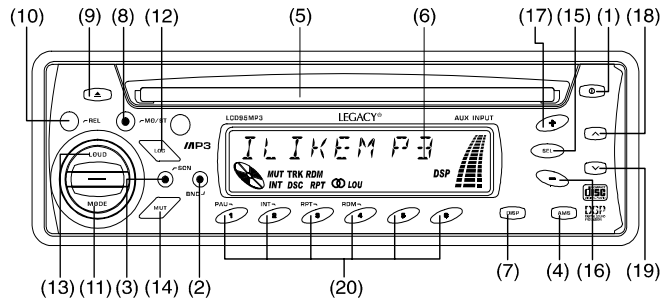

REMARK :

AT ANY TIME, IF THE WIRE IS DISCONNECTED, THE RESET SWITCH MUST BE PRESSED AGAIN BEFORE OPERATE THE RADIO (REFER TO PAGE 4 FOR DETAIL). OTHERWISE, THE RADIO MAY NOT WORK PROPERLY.

OPERATING INSTRUCTIONS

1. POWER ON/OFF CONTROL

Press the button to turn the power "ON" or "OFF".

Note : The unit can be turn on by pressing any keys on the panel (except panel release button & disc eject button). It will help the user who cannot find the power button in dark.

2. BAND SELECTOR

Each time this button is pressed, the radio band is changed. The indication "FM1", "FM2", "FM3", "MW1" or "MW2" will appear on the display according to your selection.

3. SCAN CONTROL

Press this button to scan the receivable FM / MW stations. When receivable stations are tuned in, they are monitored for approximately 5 seconds before advancing to the next receivable station. Press SCAN button once again to stop scanning as desired.

4. PRE-SCAN/AUTO-STORE BUTTON

This button allows you to enjoy "Preset Memory Scan" function by pushing it shortly, and "Auto-Store Memory" function by pushing it more than 2 seconds.

* PS (PRESET MEMORY SCAN) - It calls the memorized station frequencies (from 1-6) automatically every 5 seconds.

* AS (AUTO-STORE MEMORY) - It searches all station frequencies upward and memorize automatically 6 stations by catching the frequency which has scan-stop level, the memorized station is shown on LCD as "CH1...6". After memorizing, auto-store memory function will be changed to "Preset Memory Scan" function automatically.

5. DISC SLOT

Holding the disc and insert into the disc slot. The disc mechanism will automatically engage into CD/MP3 play mode.

6. LCD DIGITAL DISPLAY

The unit utilizes a digital type display which shows numerical indication of station FREQUENCY and other FUNCTIONS.

7. DISPLAY CONTROL

The display key serves to show available information as following:

- Time
- Track No. / Playing Time (during CD and MP3 mode)
- Directory Name / File Name (during MP3 mode and the file must contain directories or files name written by the CD writer)

SETTING CLOCK TIME

1. Press CLOCK button and hold it until the display flash and release.
2. Press "+" button to set HOUR and press "-" to set MINUTE.

8. STEREO/MONO CONTROL

Press this button to select "FM STEREO" or "MONO" reception.

9. EJECT BUTTON

Press the button to eject the disc inside disc slot.

10. PANEL RELEASE BUTTON

This button is used to release the panel from the unit. To detach the front panel, press the button so that the left side of the panel is released. Grasp the released side and pull it off of the chassis. To re-attach the panel, insert the right side of the panel in place first and then press the left side of the panel until the chassis hold the panel firmly.

11. MODE SELECTION

Press this button to select Radio (TUNER), CD/MP3 (S-CDP), CDC (not available in this model), or Auxillary input (AUX) mode. **Remark :** During mode selection, CDC will be shown on display but not available on this model. Just simply press the button one more time, it will go to the next selection.

12. LOCAL/DISTANT SELECTOR

Press this button to prevent strong local stations from overlapping weaker stations. For normal operation, press this button again for distance.

13. LOUD CONTROL

Press this button to activate the loudness circuitry which compensates for loss of high and low frequencies during low volume levels.

14. MUTE CONTROL

Press this button to mute the volume control and "MUT" will appear on LCD display.

15. AUDIO / SETTING SELECT

Briefly press the button to select volume, bass, treble, balance or fader adjustment in cyclical mode.

When pressing the button for more than 2 seconds, it activates as unit setting selection in cyclical mode as following. The unit setting can be changed by using either "VOL+" or "VOL-" button.

- **DSP OFF/ POP M/ ROCK M/ CLASS M/ FLAT M**
- **BEEP OFF/ BEEP ON** (not available for this model)
- **SEEK 1** (tune up/down button performs fast tune function)/**SEEK 2** (performs auto tuning function when tune up/down button pressed more than 1 second)
- **COLOR 1 / COLOR 2** (not available for this model)
- **VOL LAST / VOL ADJ** (preset volume level when unit turn on)

16/17. AUDIO LEVEL DOWN/UP CONTROL (- Button) / (+ Button)

Press "SEL" button shortly and then pressing "+" or "-" button to adjust level of volume, bass, treble, balance or fader.

- **VOLUME** - Press the (+) button to increase, or (-) button to decrease volume level.
- **BASS** - While "BASS" is being displayed, press (+) button to increase or (-) button to decrease the bass level.
- **TREBLE** - While "TREB" is being displayed, press (+) button to increase or (-) button to decrease the treble level.
- **BALANCE** - While "BAL" is being displayed, press (+) or (-) button to level balance of speaker right and left.
- **FADER** - While "FAD" is being displayed, press (+) or (-) button to level fader of speaker front and rear.

18/19. MANUAL UP/DOWN TUNING / TRACK SEEK UP/DOWN CONTROL

On radio mode, press the button will tune one frequency step higher or lower. Pressing the button more than 1 second can perform fast tuning function or auto tuning function.

On CD/MP3 mode, press this button will locate the beginning of the track being played or will locate the beginning of the next track. When pressing more than 2 seconds, it will move fast forward or fast backward to a specific position of a CD/MP3 track.

20. STATION PRESET BUTTON (1-6)

The PRESET BUTTONS on the unit are used to store station frequencies which you may wish to recall. Each preset button can store FM1, FM2, FM3, MW1, MW2 station frequency. Pressing the button momentarily recalls the station frequency which was memorized. There are 6 preset buttons, giving you capability of storing 18FM / 12MW.

NOTE: When the preset button to be memorized is kept pressed for more than 2 seconds, the receiving station frequency will be stored in the button pressed. After this, the memorized station can be recalled by pressing the button once.

On CD / MP3 Mode

- **Preset 1** - press this button to pause the disc played.
- **Preset 2** - press this button to scan the first 10 seconds of all the tracks on the currently selected disc.
- **Preset 3** - press this button to repeat the current track of the disc.
- **Preset 4** - press this button to play disc at random order - Disc shuffle play.
- **Preset 5** - press this button to search -10 track (for MP3 Mode only).
- **Preset 6** - press this button to search +10 track (for MP3 Mode only).

INSTRUCTION TO PLAY MP3 SONGS

IMPORTANT NOTES

- The MP3 file recording media acceptable to this unit are CD-R and CD-RW.
- The MP3 formats acceptable are limited.
- Do not attempt to play a media containing non-MP3 files or non-MP3 files with MP3 extension. Otherwise, the CD Mechanism will not working properly. If "ERROR" is shown, it is suggested to reset the radio by pressing the reset button.

PLAY ON MP3 SONG

- Insert the media with MP3 song in the disc slot. The unit will start playing and checks all the files and folder on the media.
- If MP3 files and directories are recognized, the media will start playing.
- The MP3 files and directories are accessed according to the order written by the CD writer.

TRACK SEARCH

- Press "AMS" button once and "TRK SCH" will be shown on the display.
- Press "SEL" to enter track search mode and "001" will appear on the display for you to enter track number.
- Press "+" or "-" to shift number 0 - 9 in loop rotation.
- Press "SEL" shortly to select the first digit.
- Repeat the same procedure to enter the other digits if required.
- After the track number is selected, press "SEL" button more than 2 seconds to start playing the selected track.
- If track number is not entered within 10 seconds, the unit will continue playing the current file.

FILES SEARCH

- Press "AMS" button twice and "FILE SCH" will be shown on the display
- Press "SEL" to enter file search mode.
- Press "+" or "-" to view the directories.
- After the selected directory is selected, press "+" or "-" to view the files.
- Press "SEL" to play the selected file.
- If directories or files name is not entered within 10 seconds, the unit will continue playing the current file.

CHARACTER SEARCH (OPTIONAL)

- Press "AMS" button 3 times and "CHAR SCH" will be shown on the display.
- Press "SEL" to enter into character search mode and "A" will appear on the display for you to enter first character.
- Enter whole name of files (maximum 8 characters) by pressing "+" or "-" to shift "A-Z", "0-9" & "X" (space) in loop rotation.
- Press "SEL" shortly to select the first character.
- Repeat the same procedure to enter the other characters if required.
- After the whole name of file is entered, press "SEL" button more than 2 seconds to start playing the selected track.

Remark:

- 1) The media must contain directories or files name written by the CD writer in order to use in searching.
- 2) If only partial letters are entered for searching either in directories or files name, you may not get it correctly.

EXAMPLE OF FOUNDING THE FILE NAME OF "HIT 3"

- "H" - press "+" button 7 times until "H" show on the display, then pressing "SEL" button for inputting the following character.
- "I" - press "+" button 8 times until "I" show on the display, then pressing "SEL" button for inputting the following character.
- "T" - press "-" button continuously until "T" show on the display, then pressing "SEL" button for inputting the following character.
- space - press "-" button until "X" show on the display, then pressing "SEL" button for inputting the following character.
- "3" - press "-" button until "3" show on the display, then pressing "SEL" button for inputting the character.

WIRE CONNECTION

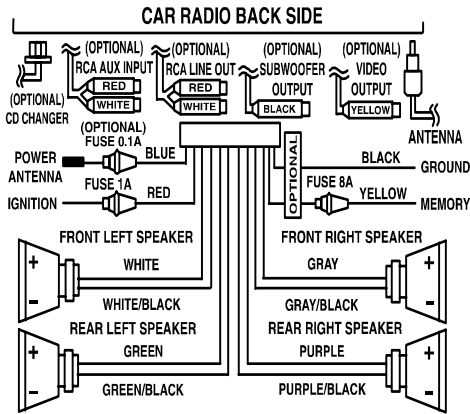

CAUTION : Do not connect the speaker wires to chassis or car body. Each speaker wire cannot be soldered together with other wires. Otherwise, the unit will be damaged and no sound will come out anymore.

REMOTE CONTROL

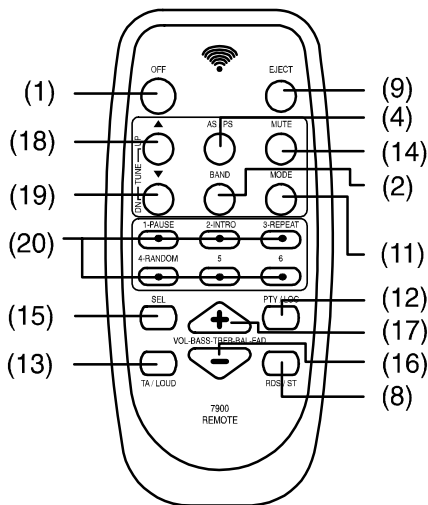

UNIT REMOVAL

1. Remove Front Control Panel.
2. Slightly insert the key into the slot and gently to release.
3. Separate the sleeve from the unit. Keep release key in a safe place as you may need for future removal of unit.

P / N : 570-C22652-03

RESET FUNCTION

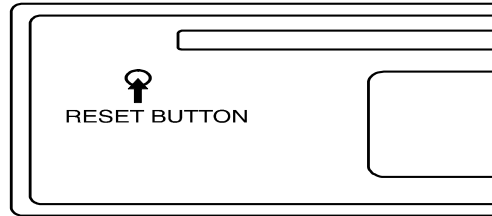

The RESET button is located on the front of main panel. It is recessed in order to prevent accidental engagement, and can be activated with the tip of a ball-point pen or any similar pointed object. This reset circuitry is provided in order to protect the unit's microprocessor, and should only be activated under the following conditions :

- a) Initial installation after all wiring is completed.
- b) Abnormal operation is encountered such as numerical indication on display is erratic.
- c) Whenever the reset button is activated, all preset memory content will be erased and must be reprogrammed.

INSTALLATION

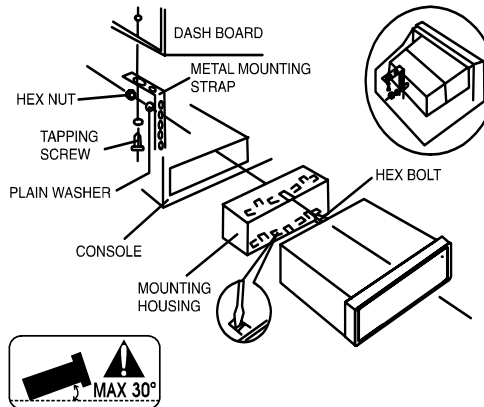

CAUTION : DO NOT PLACE THE UNIT OVER THE MAXIMUM INSTALLATION ANGLE OF 30°. OTHERWISE, THE UNIT MAY NOT WORK PROPERLY.

WARNING!!

Due to protection of CD Mechanism, two small screws on the top of the unit must be released before operate the unit. Otherwise, the CD Mechanism can not be working properly.

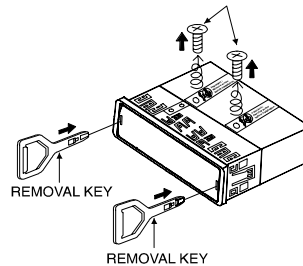

Page. 4

P / N : 570-C22652-03

Free Manuals Download Website

<http://myh66.com>

<http://usermanuals.us>

<http://www.somanuals.com>

<http://www.4manuals.cc>

<http://www.manual-lib.com>

<http://www.404manual.com>

<http://www.luxmanual.com>

<http://aubethermostatmanual.com>

Golf course search by state

<http://golfingnear.com>

Email search by domain

<http://emailbydomain.com>

Auto manuals search

<http://auto.somanuals.com>

TV manuals search

<http://tv.somanuals.com>