

The LEGO logo, consisting of the word "LEGO" in white, bold, sans-serif capital letters with a black outline, set against a red square background.

70801

THE LEGO
MOVIE

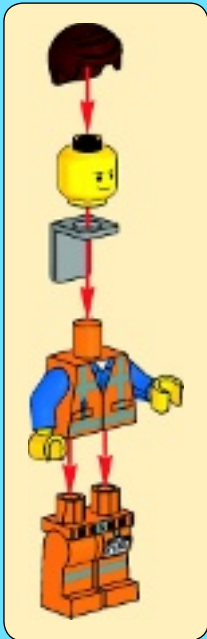



2



1

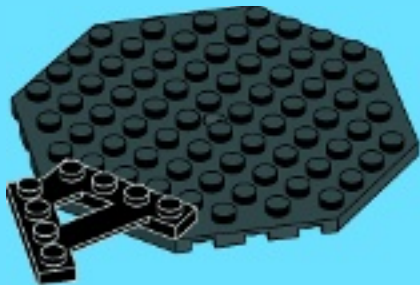



1x



1x

2



4



1x



4x

3





4





1x



1x



1x



1x



2x



1x

5

1



2



3



4



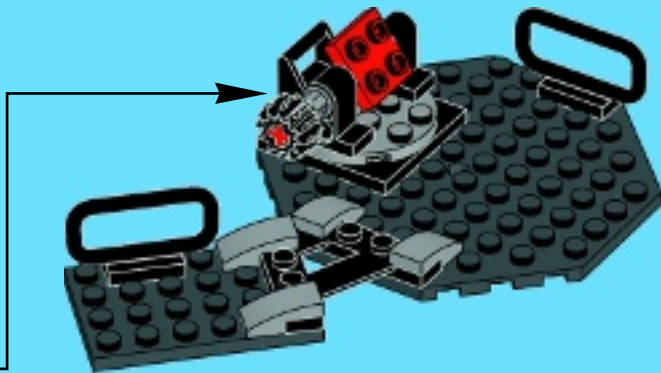



1x

1x

1



1x

2

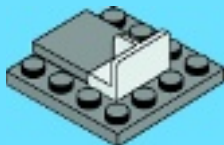



2x



1x

3

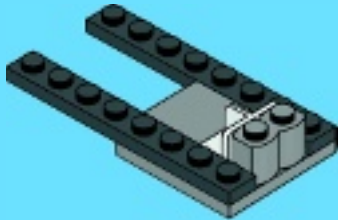

10



2x



4x

4

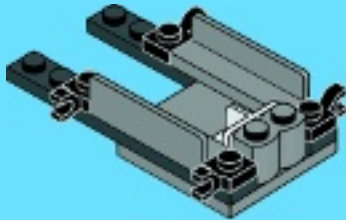



1x

5

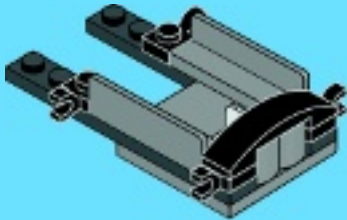

2x



2x

6

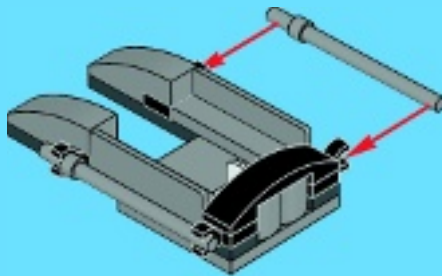



2x

7



12



2x



1x



2x

8

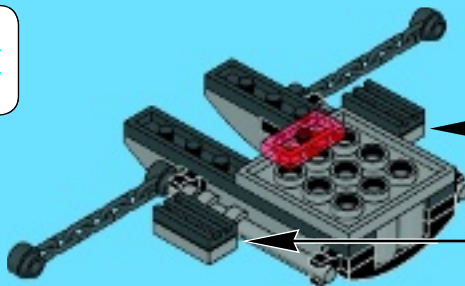
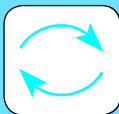

2x

6

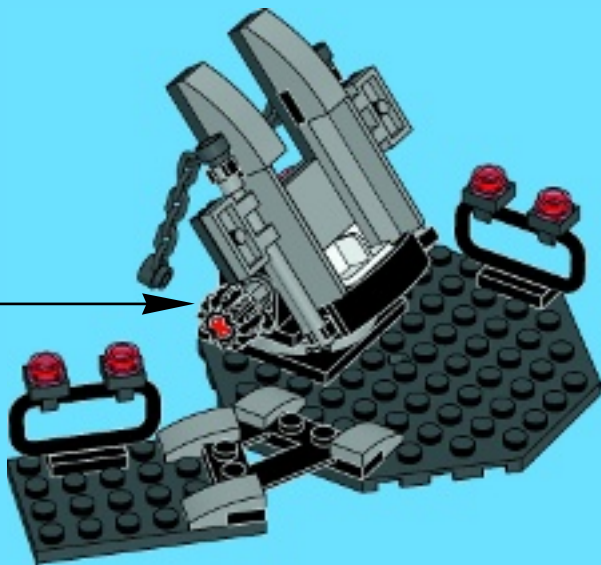



1x



1x



1x



2x

7

1



2

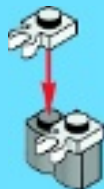

3







1x



1x



1x

8

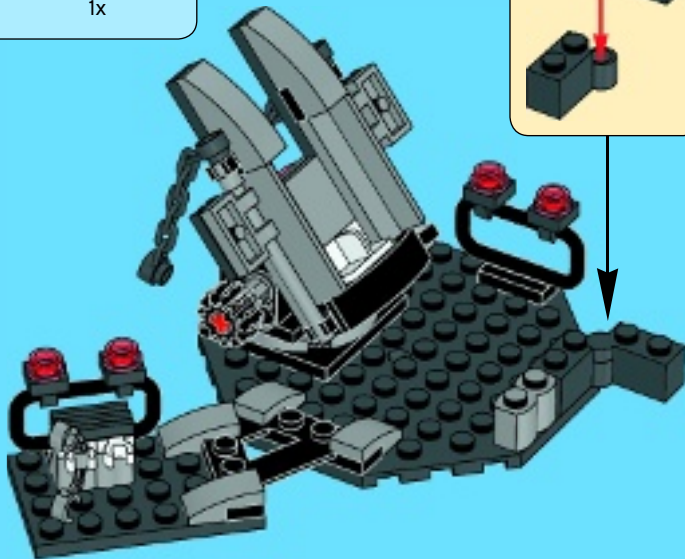
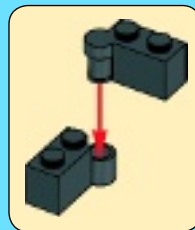



1x



1x



1x

9

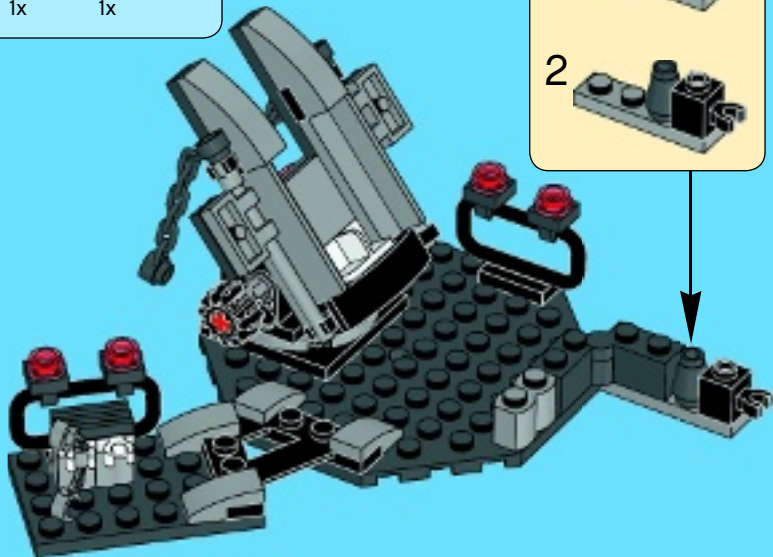

1



2

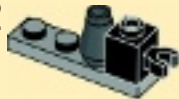



1x



1x



1x

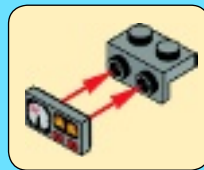

10

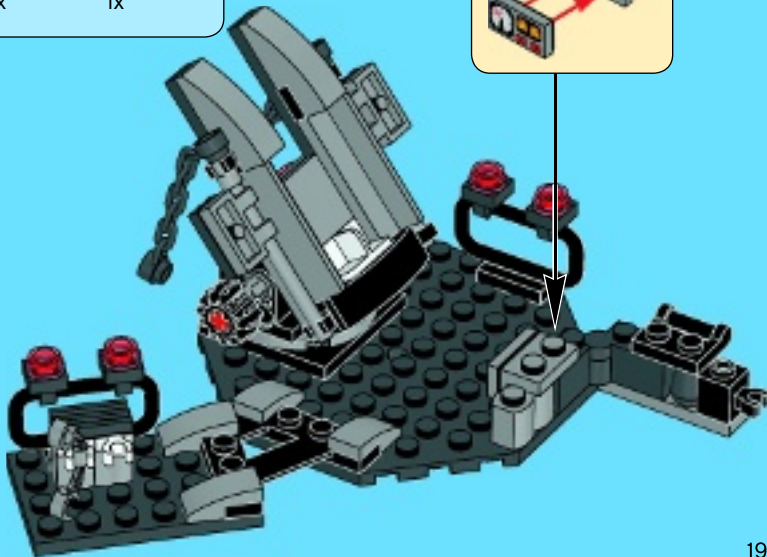



2x

11

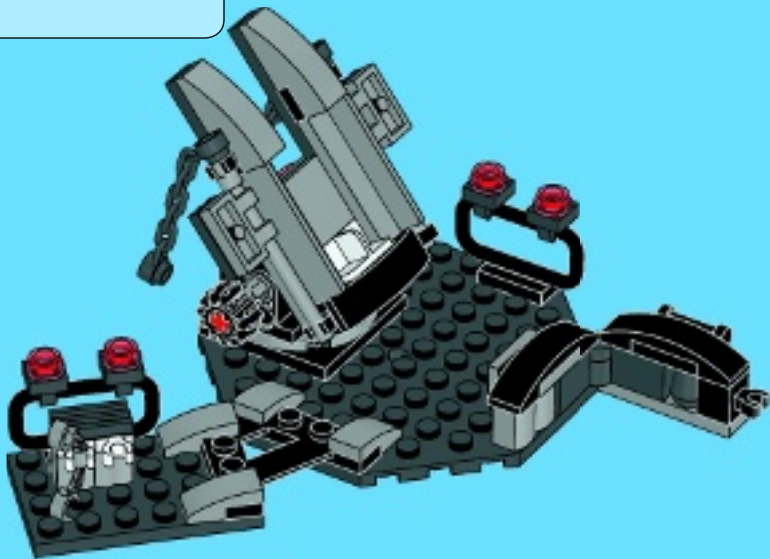

20



1x



1x



1x



1x



1x



1x



1x



1x

12

1



2

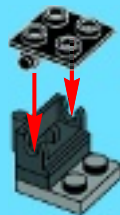

1



2



3



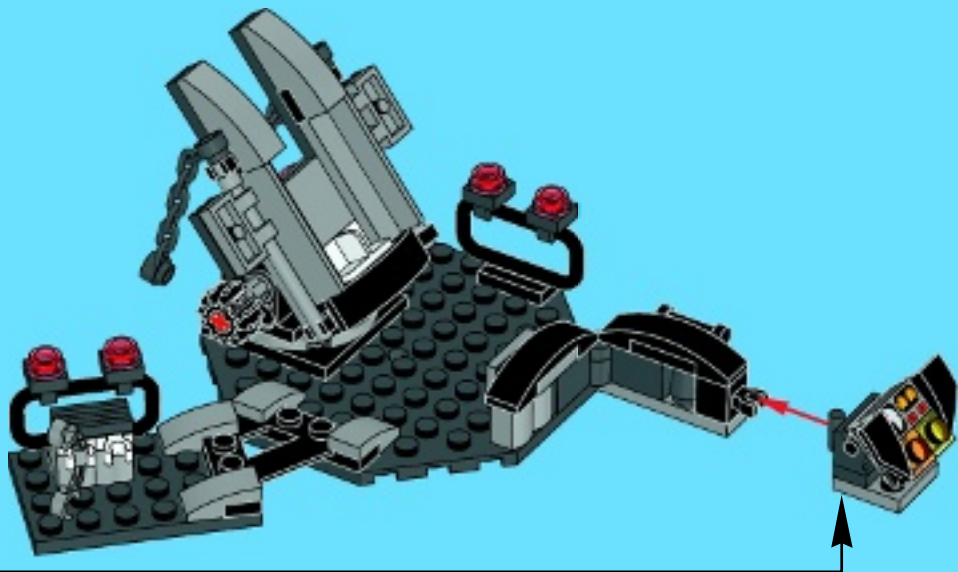



1x



1x

1



1x

2





1x

3

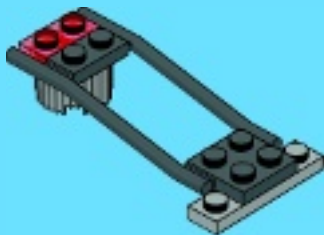

24



1x



2x



1x

4





1x



2x

5

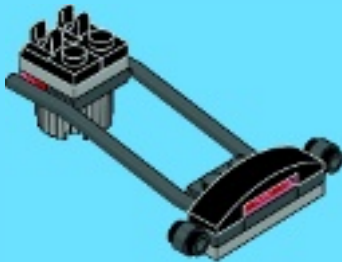

1x



2x



2x

6

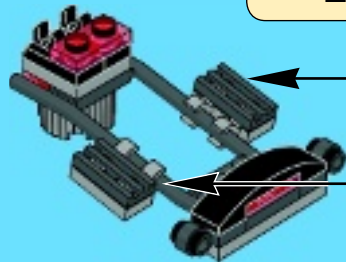
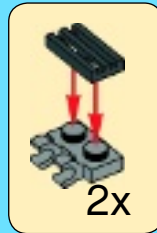



7

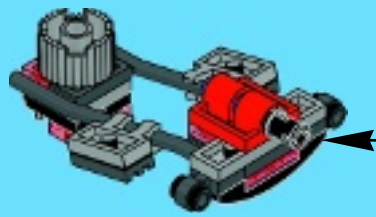
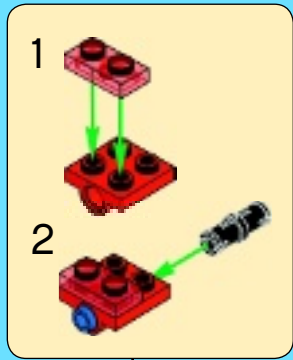
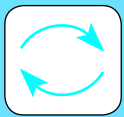

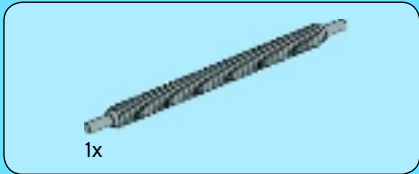

8

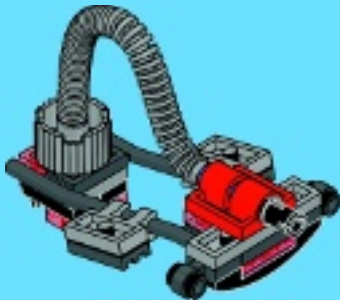

9

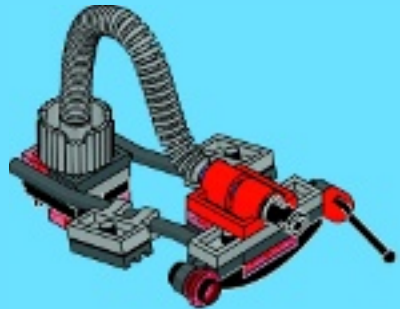

13

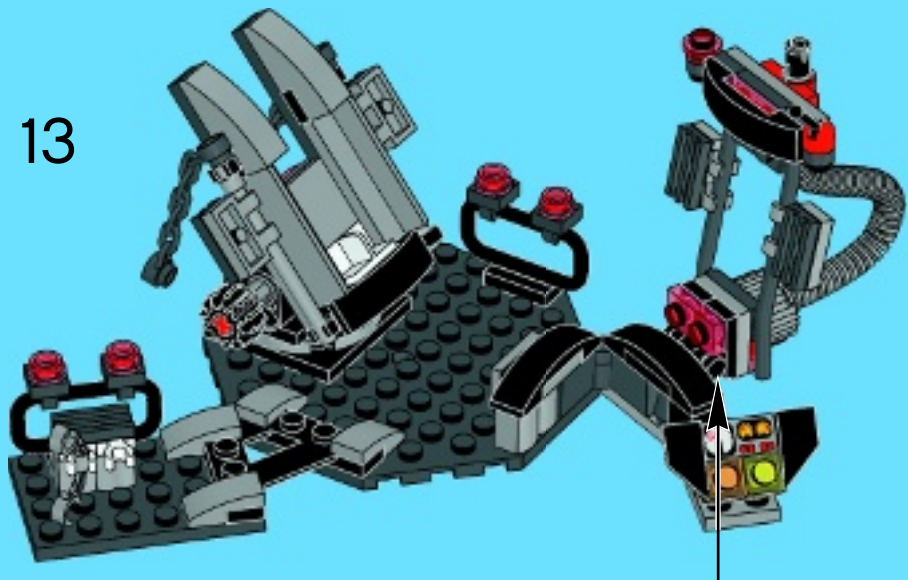



2

1

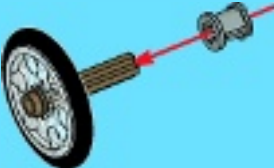



1x



1x



1x



1x

3



4

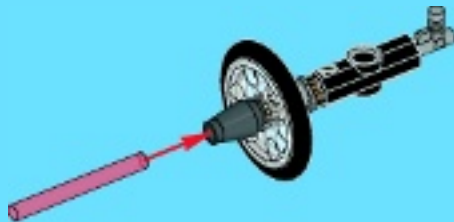

30

14

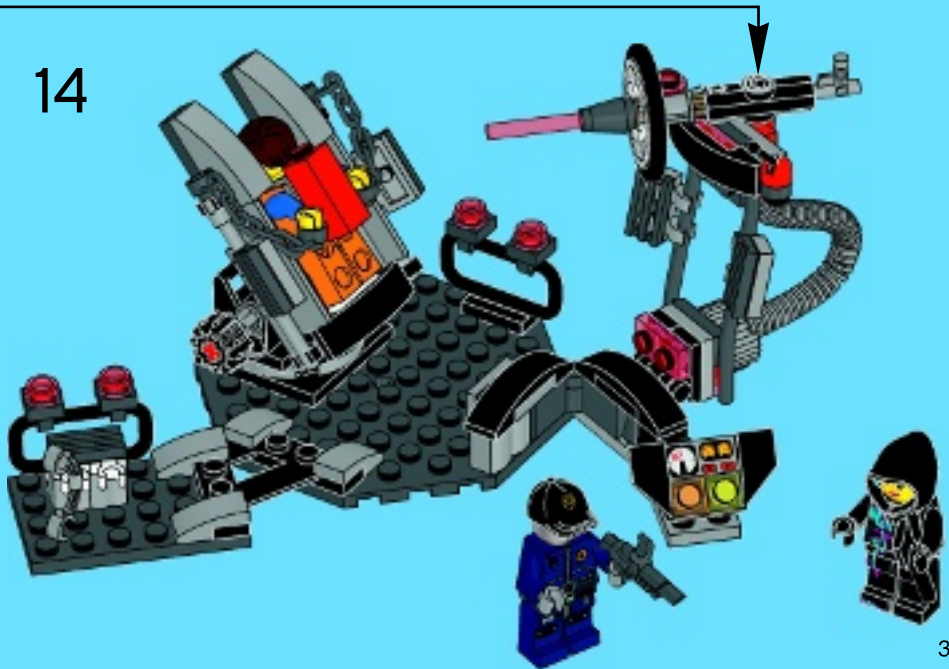



THE LEGO MOVIE



70807



70808



70802



THE LEGO MOVIE VIDEOGAME

COMING SORTIE PRÉVUE EN LANZAMIENTO 2014



PlayStation



NINTENDO 3DS. Wii U



RATING PENDING
COTE EN ATTENTE

RP

CONTENT RATED BY
CONTENU ÉVALUÉ PAR
ESRB

Visit www.esrb.org
for rating information

Visiter www.esrb.org
pour les classifications

©2014 The LEGO Group.™ & © WBEI. (s14). Nintendo trademarks and copyrights are properties of Nintendo. "PlayStation" and the/ y el logotipo de la/ et le logo "PS" Family logo are registered trademarks and the/ son marcas comerciales registradas, y el/ sont des marques commerciales déposées et le PlayStation Network logo is a trademark of/ es una marca comercial de/ est une marque déposée de Sony Computer Entertainment Inc. KINECT, Xbox, Xbox 360, Xbox One, Xbox LIVE & Xbox logos.™ Microsoft. All rights reserved/ Todos los derechos reservados/ Tous droits réservés.



2x
4613256



1x
6036409



1x
6055611



2x
281721



1x
74335



1x
4142865



1x
4143005



1x
6057810

34



1x
6057813



1x
4533771



4x
4613153



4x
4517925



2x
4598528



2x
4144024



1x
243226



1x
4225201



1x
6054852



2x
4141349



1x
6062362



1x
6062098



1x
6062931



1x
6052298



1x
383526



1x
4184813



1x
4124096



1x
4517986



1x
6028041



1x
4107783



1x
4121715



1x
4177431



1x
6062324



5x
4201019



5x
3005741



1x
4124108



1x
3000844



1x
6058044



1x
6057682



1x
6031821



1x
6058067



1x
6057705



1x
4542673



1x
6059258



3x
4550325



1x
4650645



4x
6028813



2x
4251163



2x
4211397



1x
4211413



2x
4211445



1x
4243797



2x
4227776



1x
4654582



4x
4556157



1x
4211622



1x
4515351



2x
6071299



2x
4538098



1x
4514195



1x
4641048



1x
4211760



1x
4211807



1x
4211865



1x
6056596



2x
4529240



5x
4210631



2x
4210998



1x
6062217

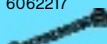

2x
4600437



1x
4268684



1x
6055607



1x
6011461



1x
4210795



4x
6030710



2x
4632574



1x
4611703



1x
4211066



1x
4211115



1x
4583688



Customer Service

Kundenservice

Service Consommateurs

Servicio Al Consumidor

LEGO.com/service or dial



: 00800 5346 5555



: 1-800-422-5346



WIN!

Go to LEGO.com/productfeedback to fill out a survey for a chance to win a cool LEGO® Product.

No purchase necessary.

Open to all residents where not prohibited.



LEGO.com/productfeedback

GEWINNE!

Nimm an der Umfrage auf LEGO.com/productfeedback teil und hab die Chance ein cooles LEGO® Produkt zu gewinnen! Die Teilnahme am Gewinnspiel führt zu keinerlei Kaufverpflichtungen. Teilnahme in allen nicht ausgeschlossenen Ländern möglich.

WIN!

Ga naar LEGO.com/productfeedback, vul een enquêteformulier in en maak kans op een cool LEGO® product. Geen aankoopverplichting. Ledereen mag deelnemen, uitgezonderd ingezetenden van landen waar een enquêteverbod geldt.

GAGNE !

Visite LEGO.com/productfeedback pour répondre à un questionnaire et avoir une chance de gagner un produit LEGO® très cool ! Aucune obligation d'achat. Ouvert à tous les résidents des pays autorisés.

当てよう!

LEGO.com/productfeedback にアクセスして、アンケートにご記入ください。当選者にはレゴ®製品を差し上げます。お買い上げの必要はありません。禁止されていない限り、すべての皆様にご利用いただけます。



LEGO.com

6073333

LEGO, the LEGO logo and the Minifigure are trademarks and/or copyrights of the/son des marques de commerce et/ou copyrights du/son marcas registradas, algunas de ellas protegidas por derechos de autor, de LEGO Group. ©2014 The LEGO Group.

THE LEGO MOVIE © The LEGO Group & Warner Bros Entertainment Inc./ LE FILM LEGO © Le Groupe LEGO et Warner Bros Entertainment Inc./ LA GRAN AVENTURA LEGO © The LEGO Group y Warner Bros Entertainment Inc. (s14)

Free Manuals Download Website

<http://myh66.com>

<http://usermanuals.us>

<http://www.somanuals.com>

<http://www.4manuals.cc>

<http://www.manual-lib.com>

<http://www.404manual.com>

<http://www.luxmanual.com>

<http://aubethermostatmanual.com>

Golf course search by state

<http://golfingnear.com>

Email search by domain

<http://emailbydomain.com>

Auto manuals search

<http://auto.somanuals.com>

TV manuals search

<http://tv.somanuals.com>