

Leica DISTO™ D2

The original laser distance meter



Leica DISTO™

3 Years
Warranty

if registered within 8 weeks after
purchase at www.disto.com

- when it has to be **right**

Leica
Geosystems

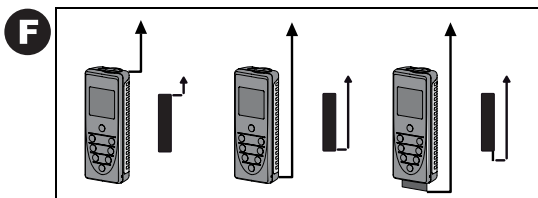
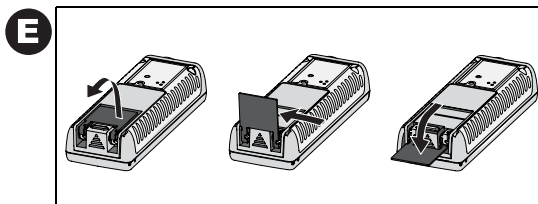
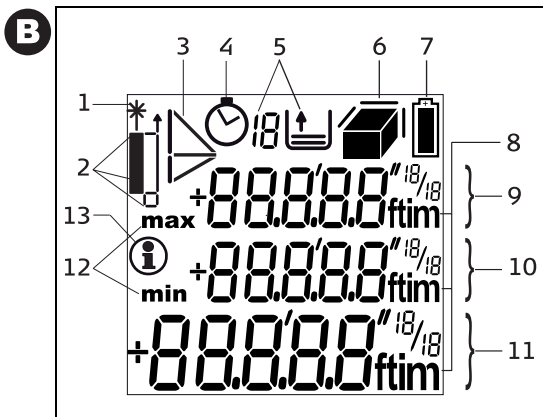
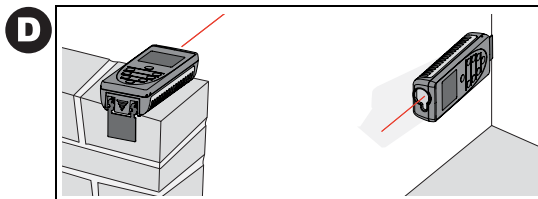
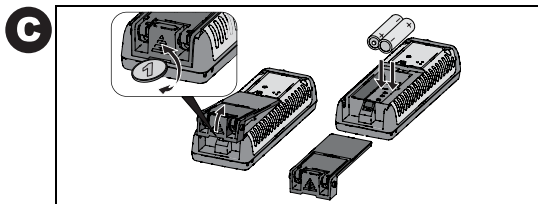
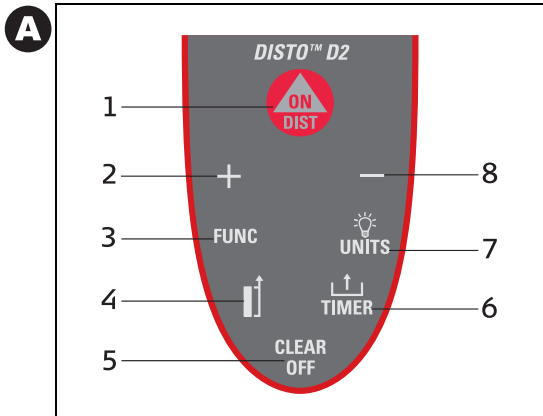

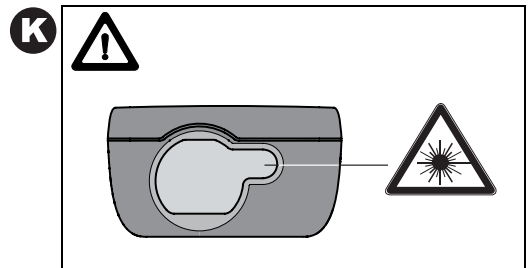
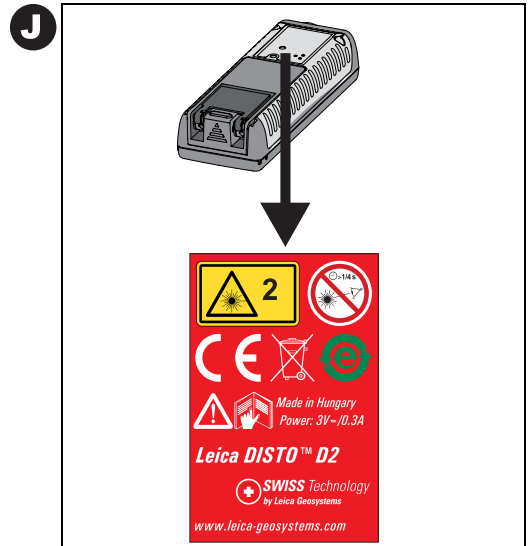
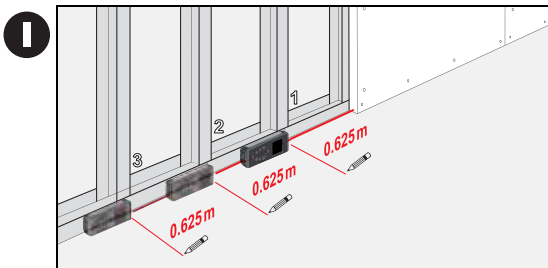
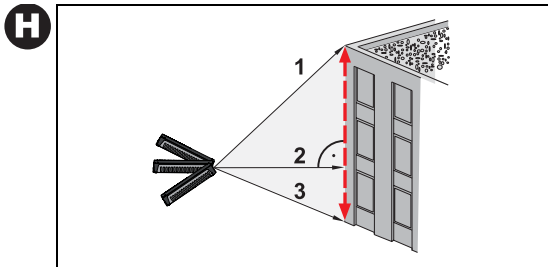
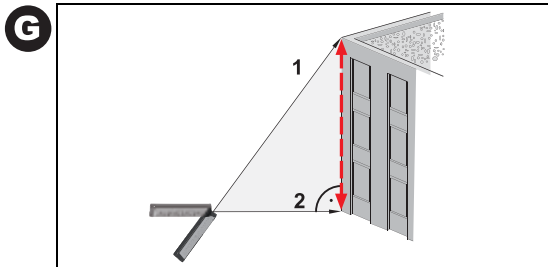

User Manual

English

Congratulations on the purchase of your Leica DISTO™ D2.



The safety instructions and the user manual should be read through carefully before you use the product for the first time. The person responsible for the product must ensure that all users understand these directions and adhere to them.

Symbols used in this manual

The symbols used have the following meaning:



WARNING

Indicates a potentially hazardous situation or an unintended use which, if not avoided, could result in death or serious injury.



CAUTION:

Indicates a potentially hazardous situation or an unintended use which, if not avoided, may result in minor injury and/or in appreciable material, financial and environmental damage.



Important paragraphs which must be adhered to in practice, as they enable the product to be used in a technically correct and efficient manner.

Intended Use

Permitted uses

- Measuring distances
- Computing functions, e.g. areas and volumes

Adverse uses

- Using the instrument without instructions
- Using outside the stated limits
- Deactivation of safety systems and removal of explanatory and hazard labels
- Opening of the equipment by using tools (screw-drivers etc.)
- Carrying out modification or conversion of the product
- Use of accessories from other manufacturers without the express approval of Leica Geosystems.
- Deliberate or irresponsible behaviour on scaffolding, when using ladders, when measuring near machines which are running, or near parts of machines or installations which are unprotected
- Aiming directly into the sun
- Deliberate dazzling of third parties; even in the dark
- Inadequate safeguards at the surveying site (e.g. when measuring on roads, construction sites, etc.)

Limits of use



Also see section "Technical data".

The Leica DISTO™ is designed for use in areas permanently habitable by humans, do not use the product in explosion hazardous areas or in aggressive environments.

Responsibilities

Responsibilities of the manufacturer of the original equipment Leica Geosystems AG, CH-9435 Heerbrugg (for short Leica Geosystems):

Leica Geosystems is responsible for supplying the product, including the User Manual and original accessories, in a completely safe condition.

(Additional language versions can be found at: www.disto.com)

Responsibilities of the manufacturer of non-Leica accessories:

The manufacturers of non-Leica accessories for the Leica DISTO™ are responsible for developing, implementing and communicating safety concepts for their products. They are also responsible for the effectiveness of these safety concepts in combination with the Leica Geosystems equipment.

Responsibilities of the person in charge of the instrument:



WARNING

The person responsible for the instrument must ensure that the equipment is used in accord-

ance with the instructions. This person is also accountable for the deployment of personnel and for their training and for the safety of the equipment when in use. The person in charge of the product has the following duties:

- To understand the safety instructions on the product and the instructions in the user manual.
- To be familiar with local safety regulations relating to accident prevention.
- To inform Leica Geosystems immediately if the equipment becomes unsafe.

Overview

Keyboard

See drawing {A}:

- 1 **ON/DIST (ON/MEAS)** - button
- 2 **PLUS [+]** - button
- 3 **FUNCTION** - button
- 4 **REFERENCE** - button
- 5 **CLEAR/OFF** - button
- 6 **HISTORICAL MEMORY/TIMER** - button
- 7 **ILLUMINATION/UNITS** - button
- 8 **MINUS [-]** - button

Display

See drawing {B}

- 1 Laser "ON"
- 2 Reference (front/rear/end piece)
- 3 Pythagoras
- 4 Timer (self-triggering)
- 5 Historical memory
- 6 Area/volume
- 7 Battery status
- 8 Units with exponents ($^2/3$)
- 9 Intermediate line 2
- 10 Intermediate line 1
- 11 Main line
- 12 min / max display
- 13 Info symbol

Start up

Inserting / Replacing Batteries

- 1 Remove battery compartment lid.
See drawing {C}.
 - 2 Insert batteries, observing correct polarity.
 - 3 Close the battery compartment.
- Replace the batteries when the symbol  flashes permanently in the display.



Only use alkaline batteries.



If the instrument will not be used for a long time, remove the batteries as a protection against corrosion.

Operation

Measuring Conditions

Range

Range is limited to 60 m.

At night or dusk and if the target is in shadow the measuring range without target plate is increased. Use a target plate to increase the measurement range during daylight, or if the target has poor reflection properties!

Target Surfaces



CAUTION:

Measuring errors can occur when measuring toward colourless liquids (e.g. water) or dust free glass, Styrofoam or similar semi-permeable surfaces. Aiming at high gloss surfaces may deflect the laser-beam and lead to measurement errors.

Hazards of Use



CAUTION:

Watch out for erroneous distance measurements if the instrument is defective or if it has been dropped or has been misused or modified.

Precautions:

Carry out periodic test measurements. Particularly after the instrument has been subject to

abnormal use, and before, during and after important measurements.

Make sure the Leica DISTO™ optic is kept clean and that there is no mechanical damage to the bumpers.



CAUTION:

In using the instrument for distance measurements or for positioning moving objects (e.g. cranes, building equipment, platforms, etc.) unforeseen events may cause erroneous measurements.

Precautions:

Only use this product as a measuring sensor, not as a control device. Your system must be configured and operated in such a way, that in case of an erroneous measurement, malfunction of the device or power failure due to installed safety measures (e.g. safety limit switch), it is assured that no damage will occur.

Switching on/off



1x briefly: the instrument and the laser are switched on.

The display shows the battery symbol  until the next button is pressed.



Pressing this button for longer switches the instrument off.

The instrument switches off automatically after three minutes of inactivity.

Setting the instrument



Press long until the desired unit is displayed.

Possible units:

	Distance	Area	Volume
1.	0.000 m	0.000 m ²	0.000 m ³
2.	0'0" ¹ / ₁₆	0.00 ft ²	0.0 ft ³
3.	0 in ¹ / ₁₆	0.00 ft ²	0.0 ft ³
4.	0.00 ft	0.00 ft ²	0.0 ft ³

CLEAR-Key



1x briefly: the last action is cancelled.

Illumination



1x briefly: the display illumination is switched on or off.

Reference Setting

Default reference setting is from the rear of the instrument.

The instrument can be set for the following measurements:

- To measure from an edge (see drawing {D}), fold out the stop bracket until it snaps in for the first time. See drawing {E}.
- To measure out of a corner (see drawing {D}), fold out the stop bracket until it snaps in, push

the stop bracket with a little force to the right side; the stop bracket can now be completely unfolded. See drawing {E}.



CAUTION:

Make sure that when measuring from the unfolded endpiece, the measuring reference is set to "End piece"!



1x briefly: the next measurement is taken from the front edge.



2x briefly: the measurement is taken from the unfolded end piece.

After one measurement, the reference returns automatically to the default setting (rear reference).



1x long: the measurements are taken with the front as reference until a new measuring reference is set



2x long: the measurements are taken from the unfolded end piece until a new measuring reference is set.

See drawing {F}.

Measuring

Single Distance Measurement



1x briefly: the laser is activated.



1x briefly: a distance measurement is taken.

The result is displayed immediately.

Continuous measurement

Distances can be measured with this function



1x long: a "beep" is sounded. A continuous measurement is started.



1x briefly: the continuous measurement is stopped.

The last measured value is displayed in the summary line.

Minimum-/Maximum-Measuring

This function enables determining the minimum or maximum distance from a specific measuring point, e.g. the determination of room diagonals (maximum value) or horizontal distance (minimum value).

Switching on continuous measurement (see above). The corresponding maximum and minimum values are displayed.

Functions

Addition / Subtraction

Distance Measurement.







1x briefly: the next measurement is added to the previous one.

- 1x briefly: the next measurement is subtracted from the previous one.

Repeat this procedure for as many times as required. The result is displayed in the summary row, the previously measured value is displayed in intermediate line 2, the value to be added in intermediate line 1.

-  1x briefly: the last step is cancelled.

Area function



-  1x briefly: The  symbol is displayed.
-  1x briefly: takes first distance measurement (e.g. length)
-  1x briefly: takes second distance measurement (e.g. width)

The result of the area measurement is displayed in the summary row, the individually measured values are displayed in intermediate lines 1 and 2.

Adding and subtracting areas

Calling up the area function and measuring areas.





Press  or  .

-  1x briefly: takes first distance measurement (e.g. length)
-  1x briefly: takes second distance measurement (e.g. width)

The result of the second area measurement, "+" flashes.

-  1x briefly: confirms the addition; the added area results are displayed in the summary row.

Volume function

-  2x briefly: the  symbol is displayed.
-  1x briefly: takes first distance measurement (e.g. length)
-  1x briefly: takes second distance measurement (e.g. width)

The result of the area measurement from the values already measured is displayed in the summary row.

-  1x briefly: takes the third distance measurement (e.g. height). The value is displayed in intermediate line 1.

The result of the area measurement is displayed in the summary row, the two previously measured values in intermediate lines 1 and 2.

Indirect Measurement

The instrument can measure distances with the Pythagorean method. This procedure facilitates in measuring distances that are difficult to access.

-  Adhere to the prescribed sequence of measurements:

- All target points must be vertical or horizontal on the surface of the wall.
- The best results are achieved when the instrument is rotated around a fixed point (e.g. the stop bracket is fully extended and the instrument is placed against a wall).
- To take the measurement, the minimum/maximum function can be called up. The minimum value is used for measurements that must be at right-angles to the target; the maximum distance is used for all other measurements.



Make sure that the first measurement and the distance to be measured are at right angles. Use the minimum/maximum function.

Indirect measurement - determining a distance using 2 auxilliary measurements

See drawing {G}



3x briefly: the  symbol is displayed.

The distance to be measured flashes in the symbol.



1x briefly: takes a measurement of the distance

The second distance to be measured flashes in the symbol



1x briefly: takes a measurement of the horizontal distance

The result of the function is displayed in the summary row.

If the  button is pressed for along time while

measuring a distance, maximum or minimum continuous measuring is activated.

Indirect measurement - determining a distance using 3 auxilliary measurements

See drawing {H}



4x briefly: the  symbol is displayed.

The distance to be measured flashes in the symbol.



1x briefly: takes a distance measurement

The second distance to be measured flashes in the symbol



1x briefly: takes a horizontal measurement.

The third distance to be measured flashes in the symbol



1x briefly: takes a measurement of the distance

The result of the function is displayed in the summary row.



If the  button is pressed for along time while measuring a distance, maximum or minimum continuous measuring is activated.

Stake out function



This function is helpful when staking out equal distances, e.g in the erection of wooden substructures. See drawing {I}



5x briefly: the  symbol is displayed.

A value is displayed in the summary row (default

value 1.000 m). This value can be adjusted to the desired stake out distance.

-  The value is increased.
-  The value is reduced.

Holding the button down accelerates the speed at which the value changes.

-  1x briefly: starts continuous measurement.



In intermediate line 1, the set distance or the next appropriate multiple thereof is displayed.

In the summary row, the distance to the next appropriate stake out point is displayed.

When approaching a stakeout point (to less than 0,10 m), the instrument starts to beep. When the point is reached, the beep sound changes and intermediate line 1 starts to flash.

-  1x briefly: distance measurement is interrupted and the instrument switches back to individual distance measuring mode.

Historical memory



-  1x briefly: the  symbol and the last measured value are displayed.

Use the "+" or "-" buttons to navigate through the last 10 values. The values can also be used in functions.

Using stored values in functions

Using added distances in area functions (e.g. wall surfaces or painters):



Adding distances (see additions / subtractions)

-  Call up area function to e.g. measure the height of a room.
-  1x briefly: calls up the historical memory and to possibly search for the correct value.
-  1x long: the value is entered into the function and the result of the function (e.g. area) is displayed.

Timer (self-triggering)

-  1x long: The  symbol is displayed.



The timer is preset to 5 seconds.

-  The value is increased.
-  The value is reduced.

Holding the buttons down increases the rate of change of the values.

The countdown starts automatically (if the laser is activated) and then triggers the measurement.

Switching off the beep

  Press and hold simultaneously for 5 seconds:

The beep is switched off.

To reactivate it, press and hold for 5 seconds.

Appendix

Display Notices

All display notices are either displayed with  or "Error". The following errors can be corrected.

	Cause	Correction
204	Calculation error	Repeat procedure
252	Temperature too high	Let device cool down.
253	Temperature too low	Warm device up
255	Received signal too weak, time for a measurement too long.	Use a target plate
256	Received signal too strong	Use target plate (gray side)
257	Faulty measurement, too much background light	Use target plate (brown side)

	Cause	Correction
258	Outside of the range of measurement	Select measurement distance within the range of measurement
Error	Cause	Correction
Error	Hardware error	Should this message remain active after switching the instrument off and on several times, please contact the dealerhip.

GB

Technical Specifications

Range	0.05 m to 60 m*
Measuring accuracy (2 σ)	typically ± 1.5 mm**
Smallest unit displayed	1 mm
Laser class	2
Laser type	635 nm, < 1 mW
Protection against splashes and dust	IP 54, dust-proof, splash-proof
Autom. power off: Laser Instrument	after 60 s after 180 s
Illumination	✓
Folding out endpiece	✓
Battery life, Type 2 x AAA	up to 5 000 measurements
Dimension	111 x 43 x 23 mm
Weight	90 g

Temperature range: Storage Operation	-25°C to +70°C 0°C to +40°C
--	--------------------------------

* Use a target plate to increase the measurement range during daylight or if the target has poor reflection properties!
 ** in favourable conditions (good target surface properties, room temperature) up to 10 m. In unfavourable conditions, such as intense sunshine, poorly reflecting target surface or high temperature variations, the deviation over distances above 10 m can increase by ± 0.15 mm/m.

Electromagnetic Compatibility (EMC)

The term "electromagnetic compatibility" is taken to mean the capability of the product to function smoothly in an environment where electromagnetic radiation and electrostatic discharges are present, and without causing electromagnetic interference to other equipment.



WARNING

The Leica DISTO™ conforms to the most stringent requirements of the relevant standards and regulations.

Yet, the possibility of the product causing interference in other equipment cannot be fully excluded.

Laser classification

The Leica DISTO™ produces a visible laser beam which emerges from the front of the instrument. See drawing {K}.

The product is a Class 2 Laser Product in accordance with:

- IEC60825-1 : 2007 "Radiation safety of laser products"

Class 2 Laser Products:

Do not stare into the beam or direct it unnecessarily at other persons. Eye protection is normally afforded by aversion responses including the blink reflex.



WARNING

Looking directly into the laser beam with optical aids (e.g. binoculars, telescopes) can be hazardous.

Precautions:

Do not look directly into the beam with optical aids.



CAUTION:

Looking into the laser beam may be hazardous to the eyes.

Precautions:

Do not stare into beam. Do not look into the laser beam. Make sure the laser is aimed above or below eye level (particularly with fixed installations, in machines, etc.).

Labelling

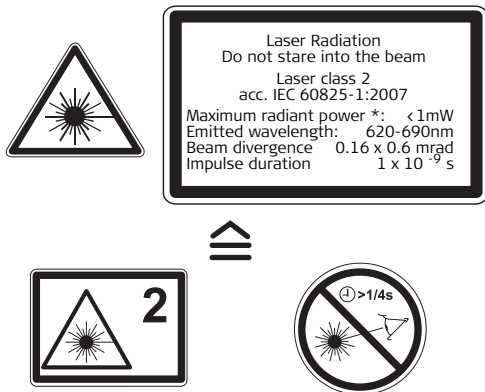

For the position of the type plate see drawing [J].

Care

Wipe off dirt with a damp, soft cloth. Do not immerse the instrument in water. Do not use aggressive cleaning agents or solutions.

Warranty

The Leica DISTO™ D2 comes with a three* year warranty from Leica Geosystems.

More detailed information can be found at:
www.disto.com

* To receive the three year warranty, the product must be registered on our website www.disto.com within eight weeks of the purchase date. If the product is not registered, a two year warranty applies.

GB

Disposal

CAUTION:
Flat batteries must not be disposed of with household waste. Care for the environment and take them to the collection points provided in accordance with national or local regulations.

 The product must not be disposed with household waste.
Dispose of the product appropriately in accordance with the national regulations in force in your country.

Adhere to the national and country specific regulations.

Product specific treatment and waste management information can be downloaded from the Leica Geosystems home page at <http://www.leica-geosystems.com/treatment> or received from your Leica Geosystems dealer.

All right reserved for changes (drawings, descriptions and technical specifications).



Leica Geosystems AG, Heerbrugg, Switzerland has been certified as being equipped with a quality system which meets the International Standards of Quality Management and Quality Systems (ISO standard 9001) and Environmental Management Systems (ISO standard 14001).

Total Quality Management - Our commitment to total customer satisfaction. Ask your local Leica Geosystems agent for more information about our TQM program.

Copyright Leica Geosystems AG, Heerbrugg,
Switzerland 2008
Translation of original text (762202b)

Pat. No.: WO 9427164, WO 9818019, WO 0244754, WO 0216964,
US 5949531, EP 1195617, US 7030969, WO 03104748



Leica Geosystems AG
CH-9435 Heerbrugg
(Switzerland)
www.disto.com

- when it has to be **right**

Leica
Geosystems

Download from Www.Somanuals.com. All Manuals Search And Download.

Free Manuals Download Website

<http://myh66.com>

<http://usermanuals.us>

<http://www.somanuals.com>

<http://www.4manuals.cc>

<http://www.manual-lib.com>

<http://www.404manual.com>

<http://www.luxmanual.com>

<http://aubethermostatmanual.com>

Golf course search by state

<http://golfingnear.com>

Email search by domain

<http://emailbydomain.com>

Auto manuals search

<http://auto.somanuals.com>

TV manuals search

<http://tv.somanuals.com>