



Leica EZ5

The OEM Stereomicroscope for Industry

Living up to Life

Leica
MICROSYSTEMS

High-Quality Inspection On Your Production Line

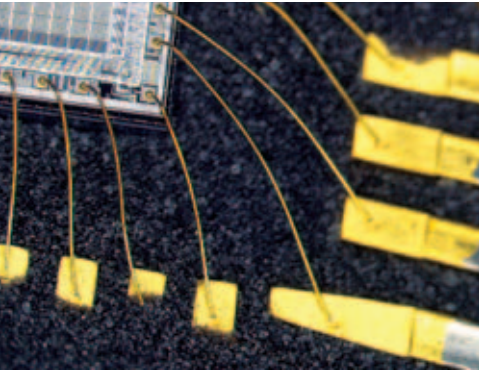

Inspection of gold wiring on a print plate



Leica EZ5 mounted to a bonder machine

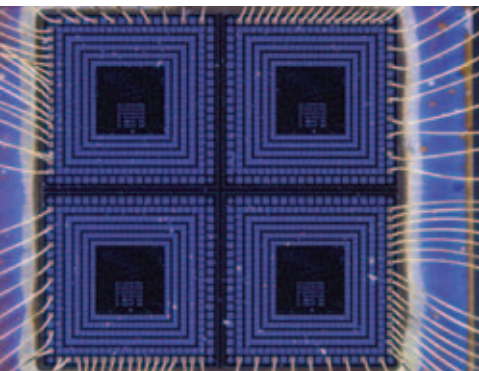

Quality control: computer chip

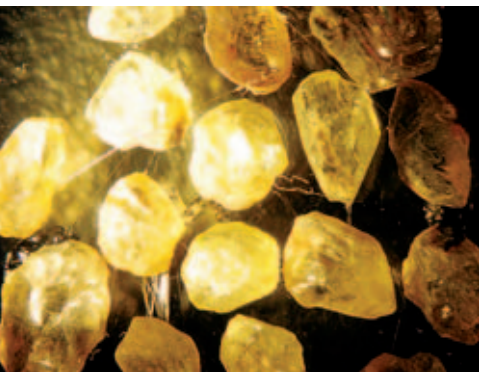

Quality control: raw diamonds

The Leica EZ5 stereomicroscope is an important part of manufacturing systems that require precise optical tests during the production and processing of components and systems. If you depend on reliable optical inspections during the production process, then the Leica EZ5 is the ideal solution for you.

The compact, lightweight Leica EZ5 stereomicroscope features high-performance optics and provides crisp, sharp image quality combined with straightforward handling. And, this easy-to-use and cost-effective stereomicroscope offers a multitude of features to ensure complete user comfort during operation. For example, Leica's ergonomic 60° eyetube angle helps the user to maintain a comfortable posture, especially when viewing objects on a tilted mount.

Along with an excellent product, Leica can provide expert guidance to solve individual problems, professional customer support, fast delivery, and prompt technical service. Whatever your needs are, Leica has the expertise to meet your expectations.

Solution for your requirements

The Leica EZ5 with 5:1 zoom ratio (10× – 50×) offers powerful magnification and high-resolution images that reveal intricate detail. Features include a 60° viewing angle and antistatic design. With 10 different types of eyepieces available, the Leica EZ5 can be fully customized to meet your current and future needs.

Benefits at a glance:

- Anti-static design
- 5:1 zoom ratio
- 10× – 50× standard magnification reveals smaller samples and structure sizes
- Eyepieces suitable for eyeglass and non-eyeglass wearers for highest user comfort
- Unrivaled resolution of 231 LP/mm makes previously invisible structures visible for inspection
- Large working distance of 100mm
- Ergonomic 60° viewing angle for comfortable use
- Simple, space-saving adaptation to bonders, probes, machines, and systems; inclinable and rotatable through 360°
- 0.5× and 0.63× auxiliary objectives for different working distances and magnifications; additional objectives also available
- Clear, sharp, distortion-free, flat, and high-contrast images ensures higher production throughput
- The best chromatic correction
- High-performance, compact, anti-static Leica L2 cold light source
- Excellent price/performance ratio

Ready for immediate use

Leica offers a variety of focus arms to adapt the Leica EZ5 to bonders, probers, and other systems quickly and easily without equipment adjustment. The Leica EZ5 can also be built into systems and fixtures using custom-made adapters.

Long working distance for effective inspection

In most cases, microscopes used for OEM purposes require a high magnification and large working distance during inspections. The Leica EZ5 standard model offers a large 100mm working distance with maximum magnification of 100× (with 20× eyepieces). The high-resolution Leica EZ5 makes previously concealed structures clear and visible. In conjunction with a high brightness level, fast and effective inspections can be accomplished.

Leica EZ5 Technical Data

Stereomicroscope	Leica EZ5
Optical System	10° – Greenough, parfocal
Magnification changer	Zoom 5:1
Eyepieces	Eyepiece 10×/20, fixed
	Eyepiece 10×/20, adjustable
	Eyepiece 16×/16, fixed
	Eyepiece 16×/16, adjustable
	Eyepiece 20×/12, fixed
	Eyepiece 20×/12, adjustable
Viewing angle	60°
Working distance	100mm
Magnification range	10× – 50×
Max resolution	231 LP/mm
Max num. aperture	0.077 nA
Object field diameter	4.0 – 20.0mm
Interpupillary distance	55mm to 75mm

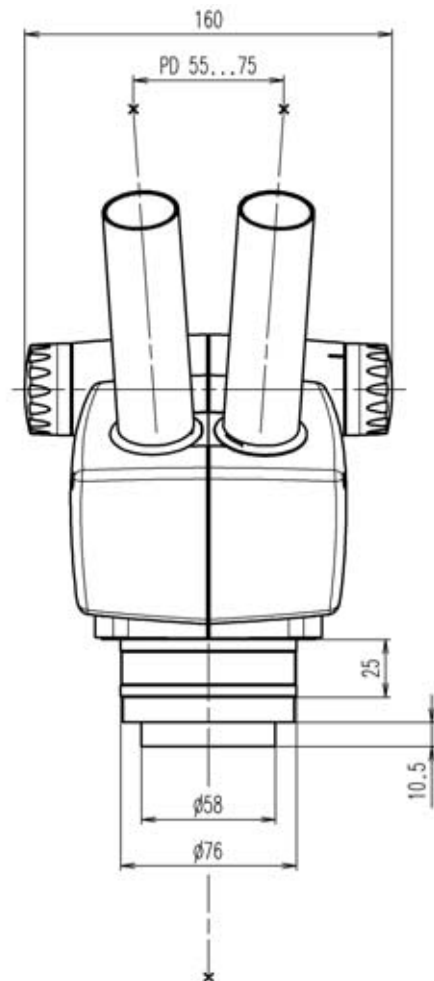
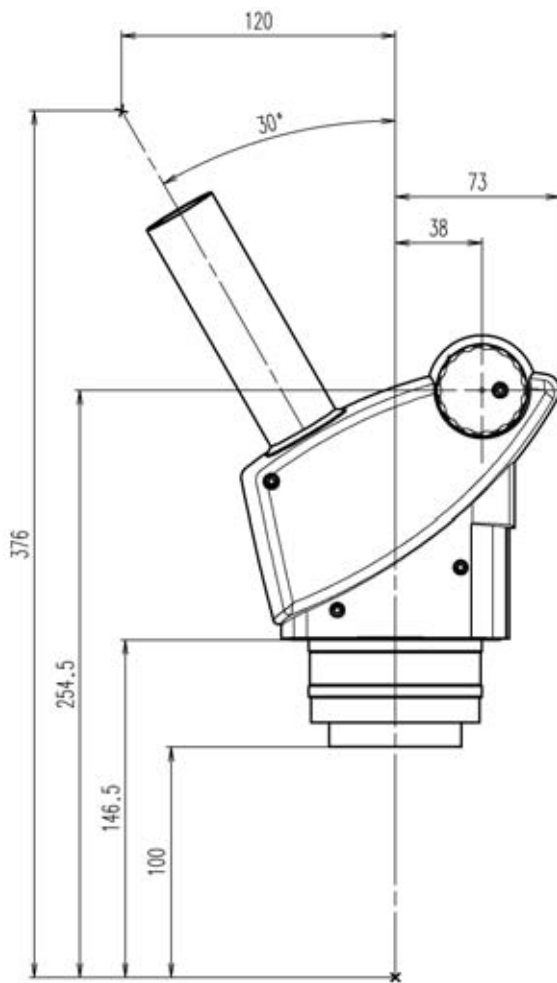

Optical data		10x/20 B		16x/15 B		20x/12	
Front objective	Working distance mm	Magnification	Object field Ø mm	Magnification	Object field Ø mm	Magnification	Object field Ø mm
	100	10 × - 50×	20 - 4	16× - 80×	15 - 3	20× - 100×	12 - 2.4
0.5×	180	5× - 25×	40 - 8	8× - 40×	7.5 - 1.5	10× - 50×	24 - 4.8
0.63×	140	6.3× - 31.5×	31.7 - 6.3	10× - 50×	23.8 - 4.8	12.6× - 63×	19 - 3.8

Leica EZ5 Dimension Drawings

Dimensions in mm

10 447 100 – 0.5x front lens

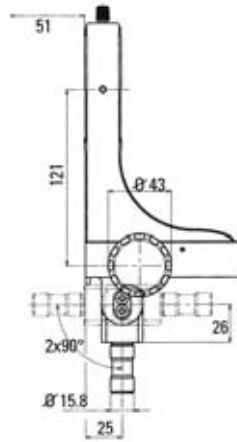
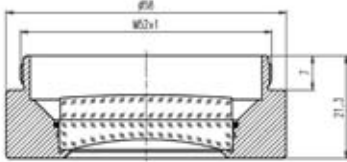

10 447 255
Mountable
focus arm

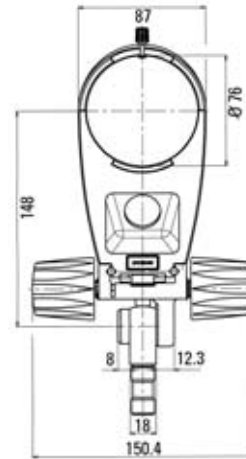

10 447 104 – 0.63x front lens

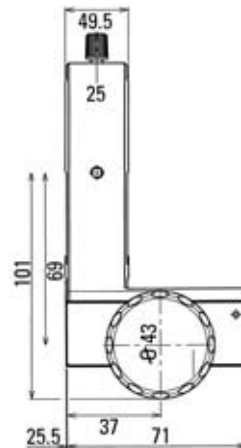
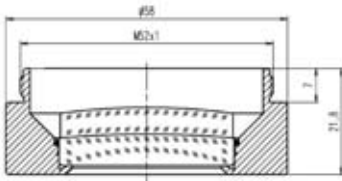

10 446 344
Focus arm
for 25mm post

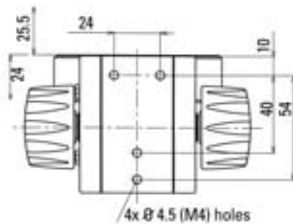
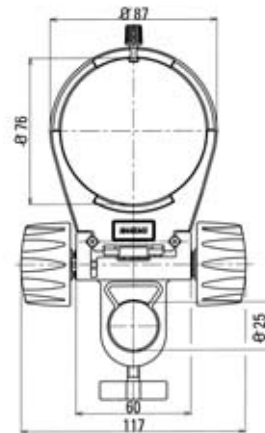

10 446 343
Focus arm

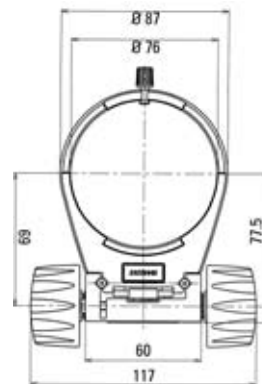
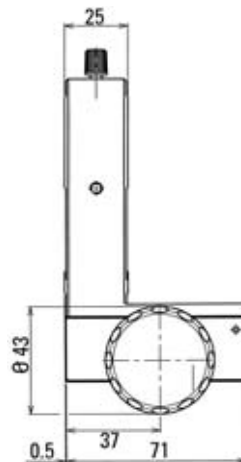

Free Manuals Download Website

<http://myh66.com>

<http://usermanuals.us>

<http://www.somanuals.com>

<http://www.4manuals.cc>

<http://www.manual-lib.com>

<http://www.404manual.com>

<http://www.luxmanual.com>

<http://aubethermostatmanual.com>

Golf course search by state

<http://golfingnear.com>

Email search by domain

<http://emailbydomain.com>

Auto manuals search

<http://auto.somanuals.com>

TV manuals search

<http://tv.somanuals.com>