



**HEARTH PRODUCTS**

HEARTH PRODUCTS  
KITS AND ACCESSORIES

750,216M  
REV. N/C 03/2006

**BLOWER KIT  
LBLK-100**

## INSTALLATION INSTRUCTIONS FOR BLOWER KIT LBLK-100 (CATALOG NO. H4678) FOR USE WITH ELDV SERIES FIREPLACES

### GENERAL INFORMATION

This blower kit may be used with ELDV series fireplaces. The LBLK-100 blower kit is used with a field supplied ON/OFF power switch. The blower is installed beneath the firebox. Room air is drawn in through the bottom area of the fireplace, heated as it passes across the firebox, and discharged through the upper open area at the top of the fireplace. The LBLK-100 blower kit contains one blower, one power cord and these instructions.

### INSTALLATION INSTRUCTIONS

**Step 1.** Turn off the fireplace and allow it to cool before proceeding.

**Step 2.** If the appliance is connected to 120 volt power, disconnect the power.

**Step 3.** Shut off the gas supply to the fireplace.

**Step 4.** Remove the bottom panel of the fireplace by pulling it forward. (see *Figure 1*).

**Step 5.** Remove the door assembly by opening the two latches (located under the door assembly) securing the glass door (see *Figure 1*).

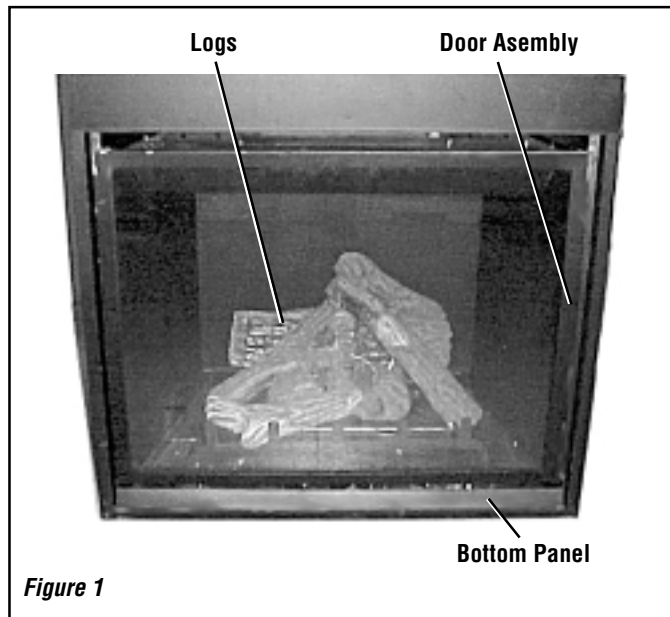

**Step 6.** Remove the logs from the fireplace (see *Figure 1*). Handle logs carefully to prevent breakage.

**Step 7.** Remove the grate assembly, burner baffle, burner assembly (see *Figure 2*) and the blower cover panel (see *Figure 3*).

**Step 8.** Connect the provided power cord to the terminals on the blower.

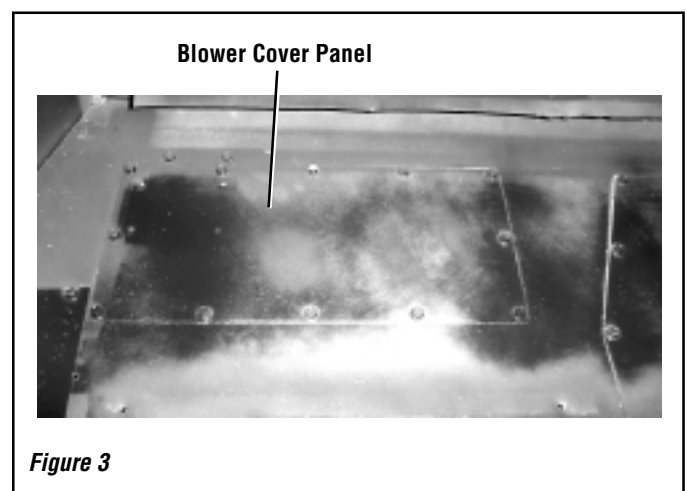
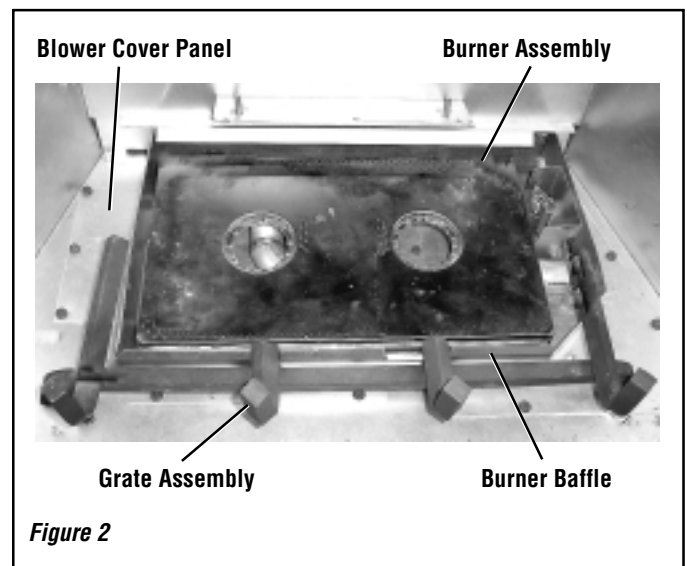

NOTE: DIAGRAMS & ILLUSTRATIONS NOT TO SCALE.

**Step 9. - Installing The LBLK-100 Blower**

**9A.** First, tilt the left side of the blower into the cutout (see *Figure 4*).

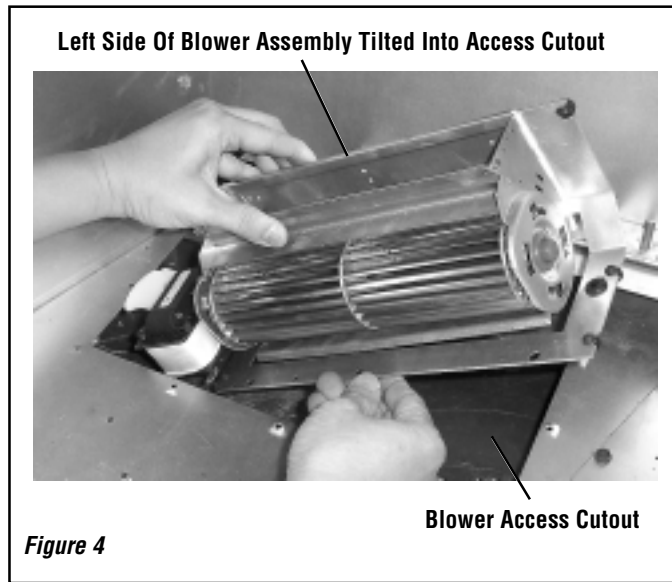

**Step 9B.** Next, rest the blower on the cabinet bottom (see *Figure 5*).

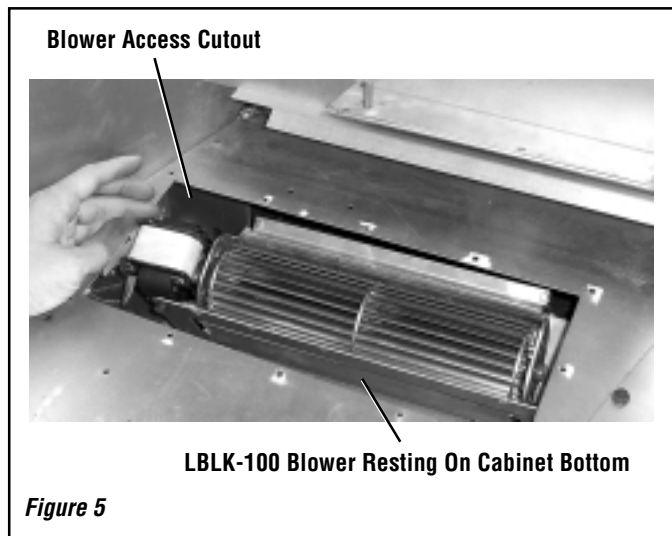

**Step 9C.** Now gently slide the blower assembly towards the back of the fireplace (see *Figure 6*).

**Step 9D.** Rotate the blower assembly so the base rests on the cabinet bottom (see *Figure 7*).

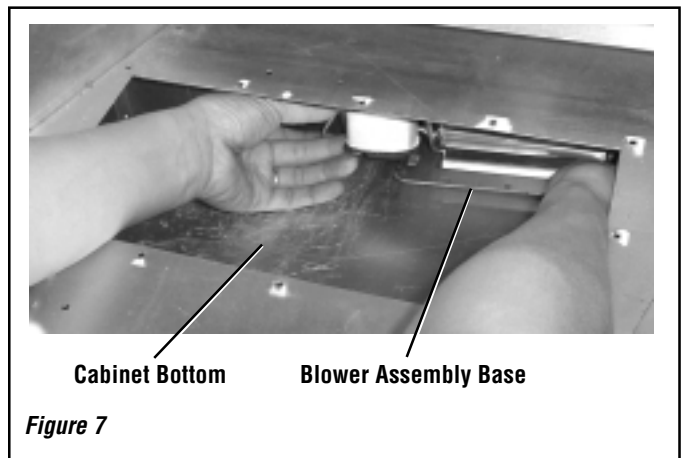
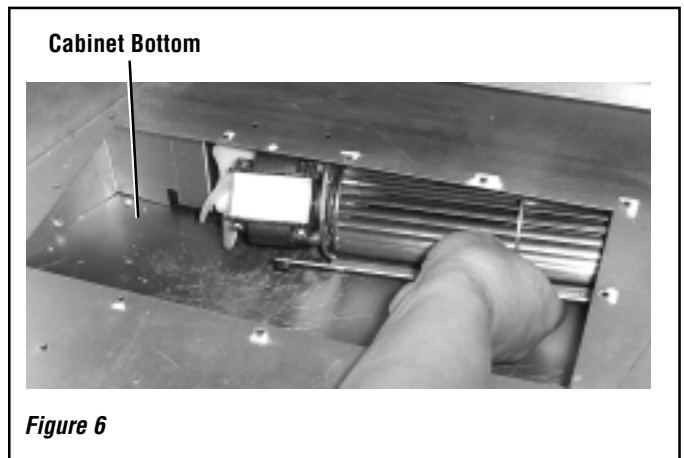

**Step 9E.** Place the blower assembly in its final position at the back of the cabinet bottom, resting on the blower mounting tabs (see *Figure 8*). Bend the mounting tabs over the blower base to secure.

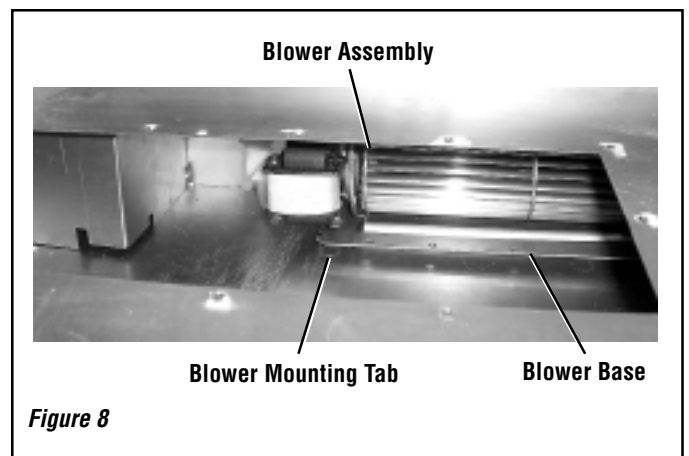

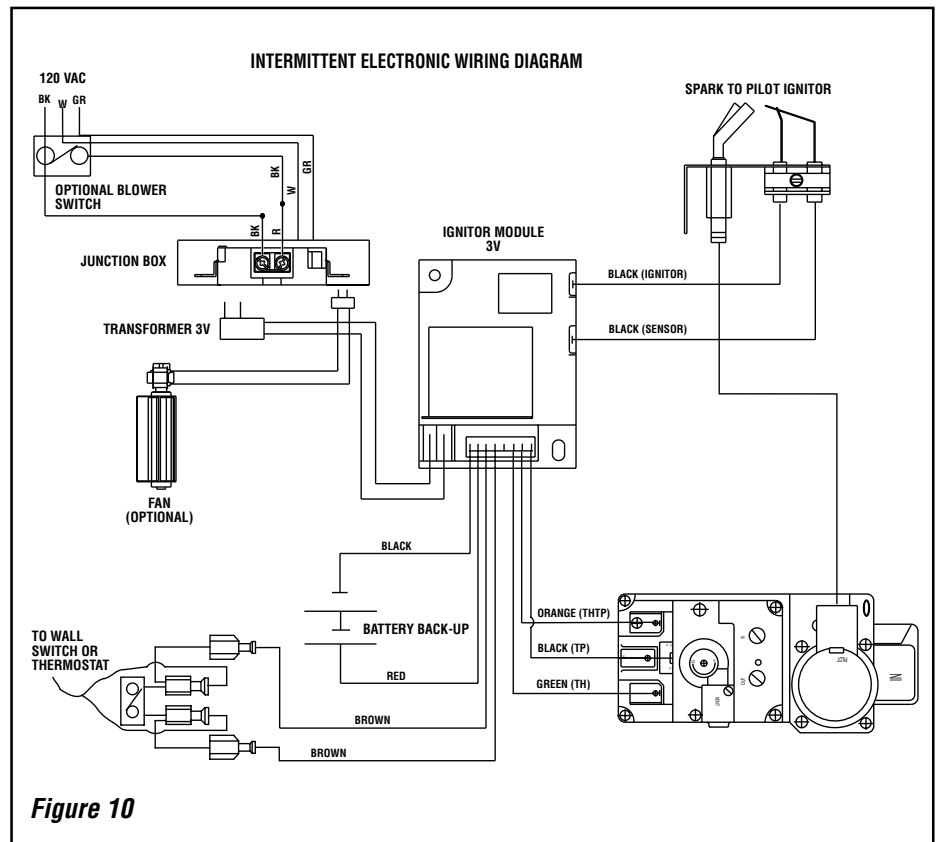
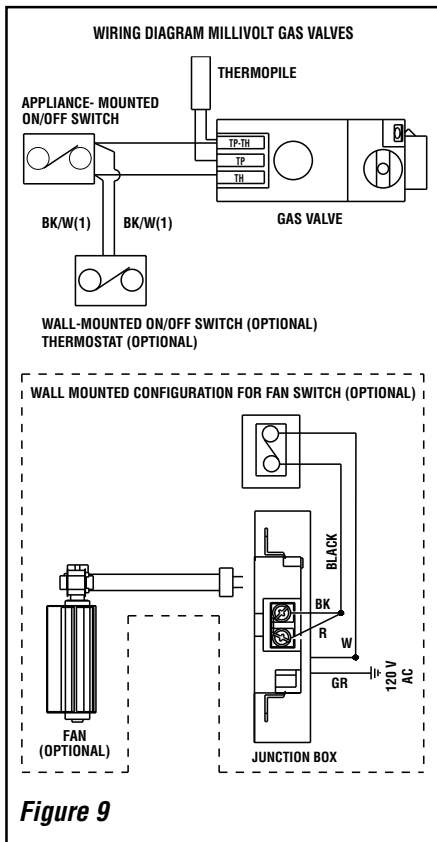

**Step 10.** Install the field-provided ON/OFF switch in a convenient location on a wall, near the fireplace.

**Step 11.** Route a 3-wire, 120Vac power line to the ON/OFF switch as shown in **Figure 9** (for Millivolt model) and **Figure 10** (for Electronic model).

Then route the wires to the unit's junction box. Remove the receptacle box by squeezing the sides of the J-Box and slide the two tabs through the cutout.

**Step 12.** Connect the supply wires to the receptacle as shown in **Figure 9** (for Millivolt) and **Figure 10** (for Electronic). Reinstall the receptacle box.

**Step 13.** Plug the blower cord into the receptacle (see **Figure 11**).

**Step 14.** Reinstall items from Steps 7, 6 and 5.

**Step 15.** Restore the electrical power to the unit.

**Step 16.** Start the fireplace by following the procedures indicated in the lighting instructions section of the Homeowners Care And Operations instructions manual, supplied with the fireplace.

**Step 17.** Check the start-up and shutdown, and the running operation of the blower.

**IMPORTANT:** Ground lead must be connected to the green screw located on the junction box. Failure to do so will prevent the appliance from operating. The appliance must be electrically grounded in accordance with local codes or, in the absence of local codes, the National Electrical Code, ANSI/NFPA 70-(latest edition). (In Canada, the current CSA C22-1 Canadian Electrical Code.)

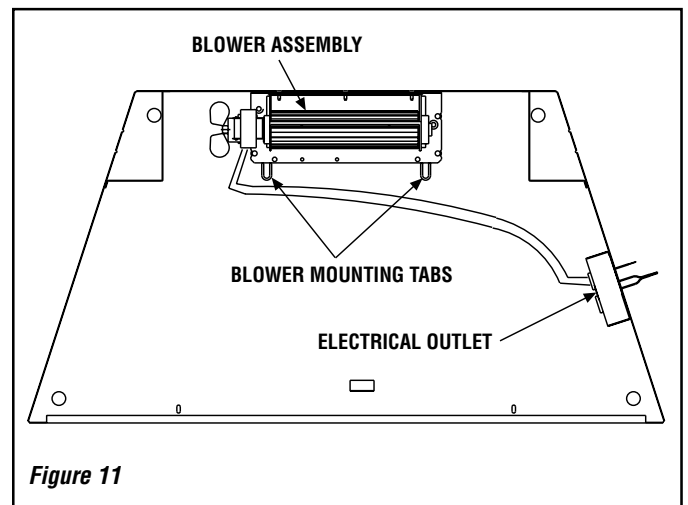

---

The manufacturer reserves the right to make changes at any time, without notice, in design, materials, specifications, prices and also to discontinue colors, styles and products. Consult your local distributor for fireplace code information.

Printed in U.S.A. © 2006 by Lennox Hearth Products

**P/N 750,216M REV. N/C 03/2006**



**HEARTH PRODUCTS**

**1110 West Taft Avenue - Orange, CA 92865**

## Free Manuals Download Website

<http://myh66.com>

<http://usermanuals.us>

<http://www.somanuals.com>

<http://www.4manuals.cc>

<http://www.manual-lib.com>

<http://www.404manual.com>

<http://www.luxmanual.com>

<http://aubethermostatmanual.com>

Golf course search by state

<http://golfingnear.com>

Email search by domain

<http://emailbydomain.com>

Auto manuals search

<http://auto.somanuals.com>

TV manuals search

<http://tv.somanuals.com>