



HEARTH PRODUCTS

P/N 875030M Rev. E 01/2011

This manual is one of a set of two supporting this product. Refer to P/N 850036M for Installation Instructions. Ce manuel est disponible en français, simplement en faire la demande. Numéro de la pièce 875030CF.

WHAT'S INSIDE

Table of Contents 2
Safety and Your Fireplace 2
FREE Safety Guard Offer (Protects Against Burns) 2
Important Safety Information 4
Attaching the Safety-in-Operation Warnings 5
[EN FRANÇAIS] L'information de sûreté importante 3-4
Apposition des mises en garde relatives à la sécurité d'utilisation 5
[EN ESPAÑOL] Información importante de seguridad 3-4
Colocación de advertencias de seguridad en operación 5

CARE AND OPERATION INSTRUCTIONS

ELDV Direct-Vent Gas Fireplaces

ELITE™ SERIES

MODELS

MILLIVOLT:

- ELDV-35NM ELDV-35PM
ELDV-40NM ELDV-40PM
ELDV-45NM ELDV-45PM

ELECTRONIC:

- ELDV-35NE
ELDV-40NE
ELDV-45NE



OTL Report No. 116-F-39C-5



INSTALLER: Leave this manual with the appliance.
CONSUMER: Retain this manual for future reference.
INSTALLATEUR : Laissez cette notice avec l'appareil.
CONSOMMATEUR : Conservez cette notice pour consultation ultérieure.



WARNING / AVERTISSEMENT / AVISO

- HOT GLASS WILL CAUSE BURNS.
DO NOT TOUCH GLASS UNTIL COOLED.
NEVER ALLOW CHILDREN TO TOUCH GLASS.



- UNE SURFACE VITRÉE CHAUDE PEUT CAUSER DES BRÛLURES.
LAISSER REFROIDIR LA SURFACE VITRÉE AVANT D'Y TOUCHER.
NE PERMETTEZ JAMAIS À UN ENFANT DE TOUCHER LA SURFACE VITRÉE.

- EL VIDRIO CALIENTE CAUSARÁ QUEMADURAS.
USTED DEBE NUNCA TOCAR EL VIDRIO CALIENTE.
LOS NIÑOS DEBEN NUNCA TOCAR EL VIDRIO.

WARNING: If the information in these instructions is not followed exactly, a fire or explosion may result, causing property damage, personal injury, or death.

- Do not store or use gasoline or other flammable vapors and liquids in the vicinity of this or any other appliance.
WHAT TO DO IF YOU SMELL GAS:
Do not try to light any appliance.
Do not touch any electrical switch; do not use any phone in your building.
Immediately call your gas supplier from a neighbor's phone. Follow the gas supplier's instructions.
If you cannot reach your gas supplier, call the fire department.
Installation and service must be performed by a qualified installer, service agency or the gas supplier.

AVERTISSEMENT : Assurez-vous de bien suivre les instructions données dans cette notice pour réduire au minimum le risque d'incendie ou d'explosion ou pour éviter tout dommage matériel, toute blessure ou la mort.

- Ne pas entreposer ni utiliser d'essence ni d'autres vapeurs ou liquides inflammables dans le voisinage de cet appareil ou de tout autre appareil.
QUE FAIRE SI VOUS SENTEZ UNE ODEUR DE GAZ :
Ne pas tenter d'allumer d'appareil.
Ne touchez à aucun interrupteur. Ne pas vous servir des téléphones se trouvant dans le bâtiment où vous trouvez.
Appelez immédiatement votre fournisseur de gaz depuis un voisin. Suivez les instructions du fournisseur.
Si vous ne pouvez rejoindre le fournisseur de gaz, appelez le service des incendies.
L'installation et l'entretien doivent être assurés par un installateur ou un service d'entretien qualifié ou par le fournisseur de gaz.

Thank you for your purchase. We appreciate your business!

Please carefully read and follow all instructions in this manual.
Pay special attention to all warnings and safety information.

Following these safety, care, and operation instructions will help ensure many years of dependable and enjoyable service from your fireplace.

• FREE SAFETY GUARD OFFER •

The Lennox® SAFETY GUARD protects against severe burns and injuries by preventing direct contact with the front glass surface of your fireplace.

To receive your FREE **SAFETY GUARD**, call **1-800-786-7976** or visit **www.lennox.com** (Lennox Hearth Products / Owner Resources)

Table of Contents

Safety and Your Fireplace	2
Important Safety Information	4
Attaching the Safety-in-Operation Warnings	5
General Information	6
Operation/Care of Your Appliance	8
Gas Controls Access	8
Variable Flame Adjustment.	9
Maintenance.	10
Front Glass Enclosure Panel, Removal and Installation	11
Install Volcanic Stone, Embers and Logs	12
Burner Flame Appearance/Sooting.	16
Burner Flame Adjustments.	17
Millivolt Appliance Checkout	17
Electronic Appliance Checkout.	17
Warranty	18
Replacement Parts.	18
Wiring Diagrams	18
Product Reference Information	19
Accessory Components	19
Lighting Instructions – Millivolt.	22
Lighting Instructions – Electronic	24
Maintenance Schedule.	26
Troubleshooting Guide – Millivolt.	27
Troubleshooting Guide – Electronic	28
Replacement Parts List	29



We recommend that our gas hearth products be installed and serviced by professionals who are certified in the U.S. by the National Fireplace Institute® (NFI) as NFI Gas Specialists.

Safety and Your Fireplace

All parts of your Lennox Hearth Products fireplace get EXTREMELY HOT!

- To prevent severe burns and injuries, install a screen or physical barrier to prevent direct contact with the glass.

To order a FREE Lennox® SAFETY GUARD for your fireplace, see details at left.

- Follow the safety instructions below and be sure everyone in your household understands this burn hazard:

- **The surfaces on your fireplace get EXTREMELY HOT!**

- **The glass on the front of the fireplace reaches EXTREMELY HIGH temperatures and can cause severe burns if touched.**

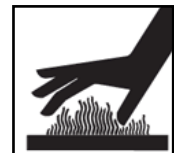

- **Keep children away from an operating fireplace. Closely supervise children in any room where a fireplace is operating to prevent contact with glass.**

- **Keep clothing, furniture, gasoline, and other flammable liquids away from the fireplace.**



- **Even after the gas is turned off, fireplace surfaces remain extremely hot.**

- Be sure to attach the enclosed **Safety-in-Operation Warnings** where you turn on your fireplace, to help remind everyone of the dangers associated with high temperatures (see **page 5**).

- Read **Important Safety Information** on **page 4**.

[FRENCH]

La sécurité et votre foyer

**Toutes les parties de votre foyer
Lennox Hearth Products deviennent
EXTRÊMEMENT CHAUDES !**

- Afin d'éviter de vous brûler gravement ou de vous blesser, installez une grille ou une barrière physique pour empêcher tout contact direct avec la vitre.

***Pour commander un PANNEAU DE PROTECTION
Lennox® GRATUIT pour votre foyer, consultez
les détails dans la partie gauche.***

- Suivez les instructions de sécurité ci-dessous et veillez à ce que tous les membres de votre famille soient conscients du danger de brûlure encouru :
 - **Les surfaces de votre foyer deviennent EXTRÊMEMENT CHAUDES !**
 - **La vitre située à l'avant du foyer atteint des températures EXTRÊMEMENT ÉLEVÉES et peut causer de graves blessures en cas de contact.**
 - **Tenez les enfants à l'écart du foyer lorsqu'il fonctionne. Surveillez attentivement les enfants dans les pièces où un foyer est utilisé afin d'éviter qu'ils ne soient en contact avec la vitre.**
 - **Tenez tous les vêtements, les meubles, l'essence et tout autre liquide inflammable à l'écart du foyer.**
 - **Même après fermeture du gaz, les surfaces du foyer restent extrêmement chaudes.**
- Veillez à coller les **Étiquettes de mise en garde relatives à la sécurité d'utilisation** à l'endroit où vous utilisez le foyer, pour rappeler à tous les utilisateurs les dangers liés aux températures élevées (**voir page 5**).
- Lisez la section **Informations importantes relatives à la sécurité, page 4.**

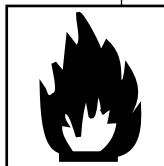

[SPANISH]

Seguridad y su chimenea

**¡Todas las partes de la chimenea
Lennox Hearth Products se ponen
MUY CALIENTES!**

- Instale una malla o barrera física para evitar el contacto directo con el vidrio y prevenir las quemaduras y lesiones graves.

***Ver los detalles a la izquierda para ordenar
un Lennox® SAFETY GUARD GRATIS
para su chimenea.***

- Siga las instrucciones de seguridad a continuación y asegúrese de que todos en su hogar sepan acerca de este peligro de quemadura:
 - **¡Las superficies de la chimenea se ponen MUY CALIENTES!**
 - **El vidrio delante de la chimenea alcanza temperaturas EXTREMADAMENTE ALTAS y puede causar quemaduras graves si se toca.**
 - **Mantenga a los niños alejados de la chimenea en funcionamiento. Supervise en forma cercana a los niños en cualquier cuarto donde haya una chimenea funcionando para impedir el contacto con el vidrio.**
 - **Mantenga la ropa, mobiliario, gasolina y otros líquidos inflamables alejados de la chimenea.**
 - **Aún después de haber apagado el gas, las superficies de la chimenea permanecen extremadamente calientes.**
- Asegúrese de colocar las **Etiquetas de advertencia de seguridad de operación** en el lugar donde enciende la chimenea, para que todos recuerden los peligros asociados con las altas temperaturas (**ver la página 5**).
- Lea la **Información importante** de seguridad en la **página 4.**

Important Safety Information

1. **WARNING:** Do not operate appliance with the glass front removed, cracked or broken. Replacement of the glass should be done by a licensed or qualified service person .
2. Do not use this appliance if any part has been under water. Immediately call a qualified service technician to inspect the appliance and to replace any part of the control system and any gas control which has been under water.
3. Due to high temperatures, the appliance should be located out of traffic and away from furniture and draperies.
4. Children and adults should be alerted to the hazards of high surface temperature and should stay away to avoid burns or clothing ignition.
5. Clothing or other flammable material should not be placed on or near the appliance.
6. Young children should be carefully supervised when they are in the same room as the appliance. Toddlers, young children, and others may be susceptible to accidental contact burns. A physical barrier is recommended if there are at-risk individuals in the house. To restrict access to a fireplace or stove, install an adjustable safety gate to keep toddlers, young children, and other at-risk individuals out of the room and away from hot surfaces.
7. Any safety screen or guard removed for servicing an appliance must be replaced prior to operating the appliance.
8. Installation and repair should be done by a qualified service person. The appliance should be inspected before use and at least annually by a professional service person. More frequent cleaning may be required due to excessive lint from carpeting, bedding material, et cetera. It is imperative that control compartments, burners, and circulating air passageways of the appliance be kept clean. See maintenance instructions on page 10.

L'information de sûreté importante

1. **AVERTISSEMENT.** Ne pas utiliser l'appareil si le panneau frontal en verre n'est pas en place, est craqué ou brisé. Confiez le remplacement du panneau à un technicien agréé
2. Ne pas utiliser cet appareil s'il a été plongé, même partiellement, dans l'eau. Appeler un technicien qualifié pour inspecter l'appareil et remplacer toute partie du système de commande et toute commande qui a été plongée dans l'eau.
3. En raison des températures élevées, l'appareil devrait être installé dans un endroit où il y a peu de circulation et loin du mobilier et des tentures.
4. Les enfants et les adultes devraient être informés des dangers que posent les températures de surface élevées et se tenir à distance afin d'éviter des brûlures ou que leurs vêtements ne s'enflamment.
5. On ne devrait pas placer de vêtements ni d'autres matières inflammables sur l'appareil ni à proximité.
6. Les jeunes enfants devraient être surveillés étroitement lorsqu'ils se trouvent dans la même pièce que l'appareil. Les tout petits, les jeunes enfants ou les adultes peuvent subir des brûlures s'ils viennent en contact avec la surface chaude. Il est recommandé d'installer une barrière physique si des personnes à risques habitent la maison. Pour empêcher l'accès à un foyer ou à un poêle, installez une barrière de sécurité ; cette mesure empêchera les tout petits, les jeunes enfants et toute autre personne à risque d'avoir accès à la pièce et aux surfaces chaudes.
7. Tout écran ou protecteur retiré pour permettre l'entretien de l'appareil doit être remis en place avant de mettre l'appareil en marche.
8. L'installation et la réparation devrait être confiées à un technicien qualifié. L'appareil devrait faire l'objet d'une inspection par un technicien professionnel avant d'être utilisé et au moins une fois l'an par la suite. Des nettoyages plus fréquents peuvent être nécessaires si les tapis, la literie, et cetera produisent une quantité importante de poussière. Il est essentiel que les compartiments abritant les commandes, les brûleurs et les conduits de circulation d'air de l'appareil soient tenus propres. Voyez les instructions d'entretien à la page 10.

[SPANISH]

Información importante de seguridad

1. **ADVERTENCIA:** No opere el artefacto con el frente de vidrio quitado, agrietado o roto. Un técnico de servicio licenciado o capacitado debe reemplazar el vidrio.
2. No use este artefacto si alguna de sus partes ha estado bajo agua. Llame de inmediato a un técnico de servicio calificado para que inspeccione el artefacto y reemplace cualquier parte del sistema de control y cualquier control de gas que haya estado bajo agua.
3. Debido a las altas temperaturas, el artefacto debe situarse fuera de las áreas de tráfico y lejos del mobiliario y cortinas.
4. Se debe alertar a los niños y adultos sobre los peligros de las altas temperaturas en la superficie y que se mantengan alejados para evitar quemaduras o ignición de la ropa.
5. No debe colocarse ropa u otros materiales inflamables sobre y cerca del artefacto.

6. Se debe supervisar de cerca a los niños cuando estén en el mismo cuarto que el artefacto. Los niños pequeños, los jóvenes y otras personas pueden ser susceptibles a quemaduras por contacto accidental. Se recomienda instalar una barrera física si hay personas en riesgo en la casa. Para restringir el acceso a una chimenea o estufa, instale una puerta de seguridad ajustable para mantener a los niños pequeños, jóvenes y otras personas en riesgo fuera del cuarto y lejos de las superficies calientes.
7. Cualquier malla o resguardo de seguridad quitado para dar servicio a un artefacto, debe reinstalarse antes de operar el artefacto.
8. Una persona de servicio competente debe realizar la instalación y reparación. Una persona de servicio profesional debe inspeccionar el artefacto antes de usar al menos una vez por año. Se puede requerir limpieza más frecuente debido a la pelusa excesiva del alfombrado, del material de cobijas, etc. Es imprescindible mantener limpios los compartimientos de control, los quemadores y los pasajes de circulación del aire del artefacto. Ver las instrucciones de mantenimiento en la página 10.

HOMEOWNER'S INSTRUCTIONS - ATTACHING SAFETY-IN-OPERATION WARNINGS

ATTACHING SAFETY-IN-OPERATION WARNINGS

Your fireplace has been furnished with safety instruction labels that are to be affixed to the operation and control point of the fireplace. A safety instruction label should be affixed to the wall switch plate where the fireplace is turned on and off (*See Figure A*) or wall thermostat (*See Figure B*) and if used on the remote control handheld transmitter (*Figure C*). The warnings should already have been put in place when the fireplace initial set-up was completed. If they are not affixed at these spots, locate the multi-lingual adhesive labels provided with these instructions and proceed as follows:

1. Locate the wall switch or wall thermostat that controls the fireplace (verify the switch operates the fireplace by turning it on and off). Clean the wall switch plate or wall thermostat thoroughly to remove any dust and oils. Affix the label to the surface of the plate of the wall switch that controls the fireplace (*Figure A*) or the wall thermostat (*Figure B*). Choose the language primarily spoken in the home.
2. If a remote control is used to control the fireplace, locate the transmitter and clean it thoroughly to remove any dust and oils. Affix the label to the surface of handheld transmitter (*Figure C*). Choose the language primarily spoken in the home.
3. If you are unable to locate the labels, please call Lennox Hearth Products or your nearest Lennox Hearth Products dealer to receive additional safety instruction labels free of charge.

Cat. No. H8024 Replacement Label Kit

LENNOX HEARTH PRODUCTS
1-800-9-LENNOX

Note: English is red text on clear label. French and Spanish are white text on black label.

SAFETY LABEL DIAGRAMS



Figure A



APPOSITION DES MISES EN GARDE RELATIVES À LA SÉCURITÉ D'UTILISATION

Votre foyer a été livré avec des étiquettes de sécurité qui doivent être collées à côté des dispositifs de contrôle du foyer. Une étiquette de sécurité doit être collée sur la plaque de l'interrupteur contrôlant l'allumage du foyer (*voir Figure A*) ou sur le thermostat mural (*voir Figure B*) et, le cas échéant, sur le boîtier de la télécommande (*Figure C*). Les mises en garde auraient dû être collées au moment de l'installation initiale du foyer. Si ce n'est pas le cas, prenez les étiquettes adhésives multilingues fournies avec ces instructions et procédez comme suit:

1. Repérez l'interrupteur ou le thermostat mural qui contrôle le foyer (vérifiez que l'interrupteur contrôle le fonctionnement du foyer en le faisant basculer de Marche à Arrêt, et vice-versa). Nettoyez soigneusement la plaque murale de l'interrupteur ou le thermostat mural pour éliminer la poussière et les traces de graisse ou d'huile. Collez l'étiquette sur la surface de la plaque de l'interrupteur mural qui contrôle le foyer (*Figure A*) ou du thermostat mural (*Figure B*). Choisissez la langue qui est principalement parlée dans la résidence du propriétaire.
2. Si une télécommande est utilisée pour contrôler le foyer, nettoyez la soigneusement pour éliminer la poussière et les traces de graisse ou d'huile. Collez l'étiquette sur le boîtier de la télécommande (*Figure C*). Choisissez la langue qui est principalement parlée dans la résidence du propriétaire.
3. Si vous ne trouvez pas les étiquettes, veuillez appeler Lennox Hearth Products ou votre distributeur Lennox Hearth Products local pour recevoir gratuitement des étiquettes supplémentaires.

Étiquettes de remplacement, n° cat. H8024

LENNOX HEARTH PRODUCTS
1-800-9-LENNOX

Remarque : Le texte anglais est rouge sur un support transparent. Le texte français et espagnol est blanc sur un support noir.

DIAGRAMMES DES ÉTIQUETTES DE SÉCURITÉ



Figure B



COLOCACIÓN DE ADVERTENCIAS DE SEGURIDAD EN OPERACIÓN

Su chimenea incluye etiquetas de instrucciones de seguridad que deben colocarse en el punto de operación y control de la chimenea. Se debe colocar una etiqueta de instrucciones de seguridad en la placa del interruptor de pared desde el cual se enciende y se apaga la chimenea (*ver la Figura A*) o en el termostato de pared (*ver la Figura B*) y en el transmisor de control remoto (*Figura C*) si se usa. Las advertencias ya deben haberse colocado cuando se completó la instalación inicial de la chimenea. Si no están colocadas en estos lugares, encuentre las etiquetas adhesivas multilingües proporcionadas con estas instrucciones y prosiga de la siguiente manera:

1. Identifique el interruptor o el termostato de pared que controla la chimenea (verifique que el interruptor opera la chimenea encendiéndola y apagándola). Limpie bien la placa del interruptor o el termostato de pared para quitar el polvo y aceite. Pegue la etiqueta en la superficie de la placa del interruptor que controla la chimenea (*Figura A*) o en el termostato de pared (*Figura B*). Seleccione el idioma que más se habla en la casa.
2. Si se usa un control remoto para controlar la chimenea, encuentre el transmisor y límpielo bien para quitar el polvo y aceite. Pegue la etiqueta en la superficie del transmisor (*Figura C*). Seleccione el idioma que más se habla en la casa.
3. Si no puede encontrar las etiquetas, sírvase llamar a Lennox Hearth Products o al distribuidor de Lennox Hearth Products más cercano para recibir etiquetas de instrucciones de seguridad adicionales gratuitas.

Juego de etiquetas de repuesto - N° de cat. H8024

LENNOX HEARTH PRODUCTS
1-800-9-LENNOX

Nota: La etiqueta en inglés es transparente con texto rojo. Las etiquetas en francés y español son negras con texto blanco.

DIAGRAMAS DE ETIQUETAS DE SEGURIDAD



Figure C



NOTE: DIAGRAMS & ILLUSTRATIONS ARE NOT TO SCALE.

General Information

The fireplace models covered in this manual are direct-vent sealed combustion gas fireplace heaters designed for residential application. These direct-vent appliances operate with the combustion chamber completely isolated from the indoor environment.

All air for combustion is brought in from the outside and exhaust gases are vented through the same direct-vent, co-axial (intake/exhaust) vent system.

The **Millivolt** appliances have a millivolt gas control valve with piezo ignition system. If any optional accessories which require electrical power are being installed, the electrical power must be provided at the time of appliance installation.

The **Electronic** appliances have a battery backed-up electronic intermittent pilot system. No external electrical power is required to operate these appliances.

These appliances comply with National Safety Standards and are tested and listed by OMNI-Test Laboratories, Inc. (Report No. 116-F-39C-5) to ANSI Z221.88 (in Canada, CSA-2.33), and CAN/CGA-2.17-M91 in both USA and Canada, as vented gas fireplace heaters.

The Installation must conform to local codes or, in the absence of local codes, with the National Fuel Gas Code, ANSI Z223.1/NFPA 54-latest edition, or the Natural Gas and Propane Installation Code, CAN/CSA B149.1-latest edition. The appliance, when installed, must be electrically grounded in accordance with local codes or, in the absence of local codes, the latest edition of the National Electrical Code, ANSI/NFPA 70, or the Canadian Electrical Code, CSA C22.1 - latest editions.

The vent termination is hot while in operation and for a period of time following the use of the fireplace. To prevent contact with hot surfaces, we recommend the use of a termination guard. See Page 21 for ordering information.

These fireplaces are designed as supplemental heaters. Therefore, it is advisable to have an alternate primary heat source when installed in a dwelling.

These appliances must not be connected to a chimney or flue serving a separate solid fuel burning appliance.

INSTALLATION, SERVICE, AND MAINTENANCE

IMPORTANT: Improper installation, adjustment, alteration, service, or maintenance can cause injury or property damage. Refer to this manual.

For assistance or additional information, consult a qualified installer, service agency or the gas supplier.

Only trim kit(s) supplied by the manufacturer shall be used in the installation of this appliance.

Draft relief openings must not be covered or blocked.

These appliances must not be connected to a chimney or flue serving a separate solid fuel burning appliance.

Any change to this appliance and/or its operating controls is dangerous. **Improper installation or use of this appliance can cause serious injury or death from fire, burns, explosion or carbon monoxide poisoning.**

Carbon Monoxide Poisoning: Early signs of carbon monoxide poisoning are similar to the flu with headaches, dizziness and/or nausea. If you have these signs, obtain fresh air immediately. Turn off the gas supply to the appliance and have it serviced by a qualified professional, as it may not be operating correctly. Some people are more affected by carbon monoxide than others, including pregnant women, people with heart or lung disease or anemia, those under the influence of alcohol, and those at high altitudes.

Turn off gas and electrical power to the fireplace and allow it to cool before cleaning or servicing the appliance.

OPERATION

Do not operate appliance with the glass front removed, cracked, or broken.

These fireplaces are vented gas appliances. **Do not burn wood or other material in these appliances.**

This appliance is only for use with the type of gas indicated on rating plate.

This appliance is not convertible for use with other gases, unless a certified kit is used.

These appliances are designed to operate on natural gas or propane gas only. The use of other fuels or combinations of fuels will degrade the performance of this system and may be dangerous.

Provide adequate clearances around air openings and adequate accessibility clearance for service and proper operation. **Never obstruct the front openings of the appliance.**

Do not use this appliance if any part has been under water. Immediately call a qualified service technician to inspect the appliance and to replace any part of the control system and any gas control that has been under water.

WARRANTY

Failure to comply with the installation and operating instructions provided will result in an improperly installed and operating appliance, voiding its warranty.

Do not attempt to alter or modify the construction of the appliance or its components. **Any modification or alteration may void the warranty, certification, and listings of this unit.**

BTU Input

Millivolt and electronic models come standard with a manually-modulated gas valve; flame appearance and heat output can be controlled at the gas valve. The BTU Input for these appliances are shown in **Table 1**.

Input (BTU/HR) (all models)		
Models	Input Rate (BTU / HR)	
	Natural Gas	Propane Gas*
ELDV35	27,000 high 21,000 low	26,000 high 20,000 low
ELDV40	29,000 high 23,000 low	27,000 high 22,000 low
ELDV45	30,000 high 23,000 low	28,000 high 21,000 low

Table 1 *Electronic valves may be converted to propane.

Gas Pressure

Tables 2 and 3 show the appliances' gas pressure requirements.

Inlet Gas Supply Pressure (all models)		
Fuel #	Minimum	Maximum
Natural Gas	4.5" WC (1.12 kPa)	10.5" WC (2.61 kPa)
Propane	11.0" WC (2.74 kPa)	13.0" WC (3.23 kPa)

Table 2

Manifold Gas Supply Pressure (all models)		
Fuel #	Low	High
Natural Gas	(Lo) 2.2" WC (0.55 kPa)	(Hi) 3.5" WC (0.87 kPa)
Propane	(Lo) 6.3" WC (1.57 kPa)	(Hi) 10.0" WC (2.49 kPa)

Table 3

Test gauge connections are provided on the front of the millivolt gas control valve, identified IN for the inlet and OUT for the manifold side (see **Figure 2** on **Page 9**). A 1/8" NPT Test gauge connection is provided at the inlet and outlet (manifold) ports on the electronic gas control valve (see **Figure 3** on **Page 9**).

These appliances must be isolated from the gas supply piping system (by closing their individual manual shut-off valve) during any pressure testing of the gas supply piping system at test pressures equal to or **less than** 1/2 psig (3.5 kPa).

These appliances and their individual shut-off valves must be disconnected from the gas supply piping system during any pressure testing of that system at pressures **greater than** 1/2 psig (3.5 kPa).

Orifice Sizes - Sea Level to High Altitude

(All Models): These appliances are tested and approved for installations at elevations of 0-4500 feet (0-1372 meters) above sea level using the standard burner orifice sizes (marked with an "*" in **Table 4**).

For higher elevations, contact your gas supplier or qualified service technician.

Install the appliance according to the regulations of the local authorities having jurisdiction and, in the USA, the National Fuel Gas Code NFPA 54 / ANSI Z223.1 - latest edition or, in Canada, the CAN/CSA-B149.1- latest edition.

Burner Orifice Sizes Elevation 0-4500 feet (0-1372 meters)		
Model Series	Nat. Gas drill size (inches)	Propane drill size (inches)
ELDV35	#38 (0.1015")* 99K76•	#53 (0.0595")* 39L10•
ELDV40	#37 (0.1040")* 24M10•	(0.062")* 21L01•
ELDV45	#36 (0.1065")* 74L88•	#52 (0.0635")* 80L41•

Table 4 * Standard size installed at factory
• Part/Cat. Number

Deration -

At higher elevations, the amount of BTU fuel value delivered must be reduced by either using gas that has been derated by the gas company or by changing the burner orifice to a smaller size as regulated by the local authorities having jurisdiction and by the (USA) National Fuel Gas Code NFPA 54/ANSI Z223.1 - latest edition or, in Canada, the CAN/CSA-B149.1 - latest edition.

Burn-in Period

During the first few fires of this appliance there will be some odor due to the curing of the paint and burning off of lubricants used in the manufacturing process. Depending on your use, the burn-in period may take a few hours or a few days.

KEEP YOUR HOUSE WELL VENTILATED DURING THE CURING PROCESS. THE ODOR AND HAZE EMITTED DURING THE CURING PROCESS CAN BE QUITE NOTICEABLE AND MAY SET OFF A SMOKE DETECTOR.

If an optional blower is installed, Do Not turn it on during the Burn-In period.

A white film may develop on the glass front during the first few fires as part of the curing process. The glass should be kept clean during the first two weeks of use to prevent the film from baking on (making it very difficult to remove). See **Cleaning Glass** on **Page 10**.

OPERATION AND CARE OF YOUR APPLIANCE

WARNING

Young children should be carefully supervised when they are in the same room as the appliance. Toddlers, young children and others may be susceptible to accidental contact burns. A physical barrier is recommended if there are at risk individuals in the house. To restrict access to a fireplace or stove, install an adjustable safety gate to keep toddlers, young children and other at risk individuals out of the room and away from hot surfaces.

AVERTISSEMENT

Les jeunes enfants devraient être surveillés étroitement lorsqu'ils se trouvent dans la même pièce que l'appareil. Les tout petits, les jeunes enfants ou les adultes peuvent subir des brûlures s'ils viennent en contact avec la surface chaude. Il est recommandé d'installer une barrière physique si des personnes à risques habitent la maison. Pour empêcher l'accès à un foyer ou à un poêle, installez une barrière de sécurité; cette mesure empêchera les tout petits, les jeunes enfants et toute autre personne à risque d'avoir accès à la pièce et aux surfaces chaudes.

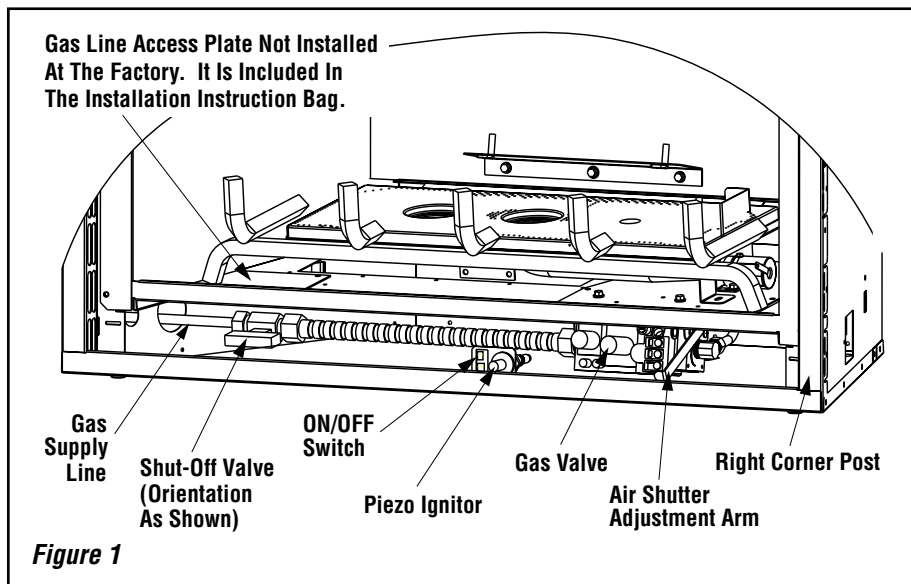

Gas Controls/Control Compartment Access

The gas controls can be found behind the control compartment access door.

Removing Control Compartment Door:

The control compartment door sits in place below the front glass enclosure panel. The door sits on the lower cabinet frame and is located by tabs on either end of the engage slots on the fireplace side rails. To remove the door, grasp it and pull it away from the fireplace.

To replace the door, engage the tabs with the slots and push it into position.

On millivolt systems, the piezo igniter, HI/LO flame adjustment knob, and pilot and main gas OFF/ON control knob are located below the glass panel enclosure. The gas valve for electronic systems is also located below the glass enclosure panel (see **Figure 1**).

The standard controls for appliance operation are located behind the panel below the appliance front glass enclosure panel (**Figure 1**). Optional control switches are also available.

Operation of millivolt and electronic gas control systems are different. Before lighting and operating your appliance determine if you have a millivolt or electronic appliance. Familiarize yourself with the gas control valve that your appliance uses. Refer to **Figure 1** for access to the gas control valve.

Millivolt Appliances - Appliances with Millivolt systems will be fitted with the gas control valve shown in **Figure 2**.

Electronic Appliances - Appliances with electronic systems will be fitted with the electronic valve shown in **Figure 3**.

Millivolt Appliances - To light millivolt appliances refer to **Figure 1**. Detailed lighting instructions are found on **Pages 22 and 23**. **Millivolt appliance lighting instructions may also be found on the pull out lighting instruction labels attached to the gas control valve.**

Once the pilot is lit, the main burner may be turned ON and OFF using wall switch, remote control, optional on unit rocker switch (FRS), or wall thermostat. To operate: Toggle the switch between its ON and OFF positions.

If your millivolt appliance is equipped with an optional remote switch kit (wall switch, remote control, rocker switch, or wall thermostat) and the pilot is lit, the appliance main burner may be turned on and off using the optional switch.

Note: To prevent excessive resistance in burner circuit (which can cause burner operation problems), only one burner control switch should be wired to valve.

Electronic Appliances -

To light electronic appliances refer to the detailed lighting instructions found on **Pages 24 and 25** of these instructions. Electronic appliance lighting instructions may also be found on the pull out lighting instruction labels attached to the gas control valve.

If your electronic appliance is equipped with an optional remote wall switch or remote control kit the appliance main burner may be turned on and off with the wall switch or remote control.

If your electronic appliance is not equipped with a wall switch or remote control, the main burner must be turned off and on with a gas control switch located in some other location by the installer. Contact the installer for directions. Check batteries, if installed, routinely (ever three months).

TO LIGHT YOUR APPLIANCE IN A POWER OUTAGE DO THE FOLLOWING:

- Install batteries in battery pack.
- Turn unit mounted switch or wall switch to the ON Position.
- Unit should spark at pilot and light.
- Operate Normally.
- Replace batteries if needed.
- After power is restored, remove batteries.

Note: It is recommended that batteries not be installed in the battery holder until a power outage, or if the appliance is to be operated solely with two (2) "D" batteries.

Refer to the Lighting Instructions on **Pages 24 and 25** to light the appliance in the event of a power failure.

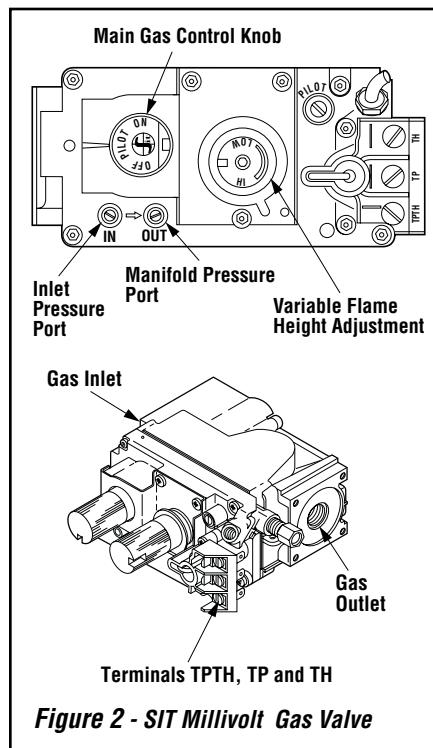

Figure 2 - SIT Millivolt Gas Valve

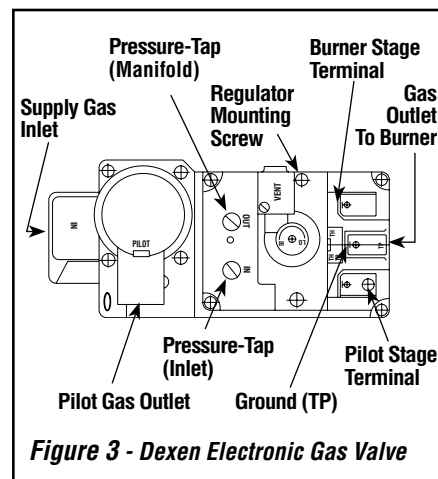

Figure 3 - Dexen Electronic Gas Valve

Variable Flame Height Adjustment

All millivolt and electronic appliances are equipped with a variable gas control valve. Flame height for these models may be adjusted through a range between fixed low and high settings while the appliance is in operation. Adjust the flame height as desired after lighting the appliance by rotating the variable adjustment control knob (HI/LO) located on the front of the valve (refer to **Figures 2 and 3**).

MAINTENANCE

(See Maintenance Schedule, Page 26)

Refer to the maintenance schedule for maintenance tasks, procedures, periodicity and by whom they should be performed. Always verify proper operation of the appliance after servicing.



WARNING

Turn off gas and electrical power to the fireplace and allow it to cool before cleaning or servicing the appliance.

CAUTION: Wear gloves and safety glasses for protection while doing required maintenance.

Verify proper operation after servicing.

S'assurer que l'appareil fonctionne adéquatement une fois l'entretien terminé.

Always turn off gas to the pilot (millivolt appliances) before cleaning. Before re-lighting, refer to the lighting instructions in this manual. Instructions are also found on a pull-out panel located in the control compartment.

Before re-lighting the fireplace, refer to the lighting instructions in this manual. Instructions are also found on pull-out panels located below the glass door in the control compartment.

Inspect Venting System

The appliance and venting system should be thoroughly inspected before initial use and at least annually by a qualified service technician (inspection should include ensuring that exhaust or intake passages are unobstructed and vent components are properly assembled and not damaged). **Homeowner must contact a qualified service technician at once if any abnormal condition is observed.**

If the venting system is disassembled for any reason, a qualified service technician should follow vent installation instructions for proper reassembly and proper sealing of the venting system components. However, more frequent periodic inspections and cleanings should be performed by the homeowner.

Cleaning Glass

(see *Front Glass Enclosure Panel, Removal and Installation* on **Page 11**).

Note: Clean glass after first two weeks of operation (after Burn-In period is over) and then only when necessary and when the fireplace is cool. Wipe surface with clean, dampened, soft cloth. Follow with dry, soft towel as desired. Take care not to scratch the glass surface.

The viewing glass should be cleaned periodically to remove any build-up caused from the following:

IMPORTANT: Do not use abrasive cleaners on glass. Never clean the glass when it is hot.

- During start-up, it is normal for condensation to form on the inside of the glass (this condensation and fog will usually disappear in a few minutes). The moisture can cause lint, dust and other airborne particles to cling to the glass surface.
- Initial curing of the high temperature paint and burning off of lubricants used in the manufacturing process may result in a film on the glass.
- A white coating may form on the glass as a result of impurities and minerals in the fuel.

It is recommended that the glass be cleaned two or three times during each heating season, depending on the circumstances present. The following cleaning solutions are approved for use to clean glass:

- Non-ammonia based household cleaner
- 50%-50% mix of white vinegar and water
- Gas fireplace/stove glass cleaner

Inspect Glass Gasket - Visually inspect the gasket on the backside of the glass enclosure panels. The gasket surface must be clean, free of irregularities and seated firmly.

Clean Control Compartment

Keep control compartment clean by vacuuming or brushing at least twice a year. More frequent cleaning may be required due to excessive lint from carpeting, bedding materials, etc. It is important that control compartments, burners and circulating air passageways of the appliance be kept clean.

Clean Logs And Burner

Carefully remove the logs (use care when handling the fiber logs, as they become quite fragile after curing). Vacuum out any foreign matter (lint, carbon, etc.) on the burner. Ensure the burner ports are "open." Remove any carbon deposits from the under side of the logs using a vacuum cleaner, or a soft bristled brush (i.e. paint brush).

Note: Improper positioning of logs can create carbon build-up and will alter the performance of the appliance.

Replacing Logs

If the logs become damaged by accident or improper handling and need replacement, use only the proper replacement logs from manufacturer (see **Page 29** for ordering information).

Re-Install Embers and Logs

Carefully follow placement instructions on **Pages 12 through 14**. All logs should fit onto corresponding pins and/or log stoppers. This will ensure a proper flame and safe combustion.

Inspect Wiring

Refer to wiring diagrams on **Page 18**.

CAUTION: Label all wires prior to disconnection when servicing controls. Wiring errors can cause improper and dangerous operation. Verify proper operation after servicing.

ATTENTION: Au moment de l'entretien des commandes, étiquetez tous les fils avant de les débrancher. Des erreurs de câblage peuvent entraîner un fonctionnement inadéquat et dangereux.

Inspect and clean all wire connections. Ensure that there is no melting or damage. Inspection should include:

- Terminals at the Valve
- OFF/ON Switch
- (Optional Control Switch) Wall Thermostat, Remote Control or Remote Wall Switch Kit

Inspect Burner Flame Appearance

Ensure that the burner flame appearance resembles the flame shown in **Figures 11 through 13** and as described in *Flame Appearance and Sooting* on **Page 16**. The Homeowner must contact a qualified service technician at once if any abnormal condition is observed.

Small Area Paint Touch-up

The finish of the appliance is a high-quality powdercoat. Only use factory supplied powdercoat paint kit for touch-ups. Paint is available at your local authorized Lennox Hearth Products dealer. Never attempt to paint a hot fireplace.

Do not attempt to repaint the appliance until the finish is completely cured (see *Burn-In Period* on **Page 7**). If the surface later becomes stained or marred, it may be lightly sanded and touched up with spray paint.

Front Glass Enclosure Panel, Removal and Installation

! WARNING

- Do not attempt to substitute the materials used on this door, or replace cracked or broken glass.
- Handle this glass with extreme care! Glass is susceptible to damage – Do not scratch or handle roughly while reinstalling the glass door frame.
- The glass door(s) of this appliance must only be replaced as a complete unit as provided by the manufacturer. Do not attempt to replace broken, cracked or chipped glass separately.
- Do not attempt to touch the front enclosure glass with your hands while the fireplace is in use.

! WARNING

Do not operate appliance with the glass front removed, cracked or broken.

! AVERTISSEMENT

Ne pas utiliser l'appareil si le panneau frontal en verre n'est pas en place, est craqué ou brisé.

! WARNING

Any safety screen or guard removed for servicing the appliance must be replaced prior to operating the appliance.

! AVERTISSEMENT

Tout écran ou protecteur retiré pour permettre l'entretien de l'appareil doit être remis en place avant de mettre l'appareil en marche.

Only doors certified with the appliance shall be used.

Seules des portes certifiées pour cet appareil doivent être utilisées.

CAUTION: DO NOT abuse glass door by striking or slamming shut.

These are direct-vent appliances. They are designed to operate only when the front glass enclosure panels are installed. Generally the front glass enclosure panel should not be removed except to gain access to the components within the firebox.

Removing Glass Enclosure Panels (see *Figure 5*)

1. To access the glass door securing latches, first open the lower control compartment door (*Figure 5*) by lifting and pulling the bottom panel forward.
2. Pull the latches forward and down to release them from the door channel.
3. Pull the bottom of the door out a few inches and grasp it on the right and left. Gently lift to release the door from its channel above the door. Pull the door forward.
4. Retrieve the glass door. Visually inspect the gasket on the backside of the frame. Gasket surface must be clean, free of irregularities and seated firmly.

5. Position the door in front of the firebox opening with the bottom of the door held away from the fireplace (*Figure 5*). Hook the top flange of the door frame over the top of the firebox frame.
6. Let the bottom of the door frame swing gently in towards the fireplace ensuring that the gasket seats evenly as the door frame draws shut. Fasten the two latches located underneath the firebox floor to the door's vee-flange. Close both the latches securely.
7. If desired, install the optional hood. Note the location of the three clips inside the top air channel above the door. The clips are equally spaced on the top surface of the air channel opening. Use a screwdriver to open the clips slightly if needed. Engage the back edge of the eyebrow into the clips to secure.

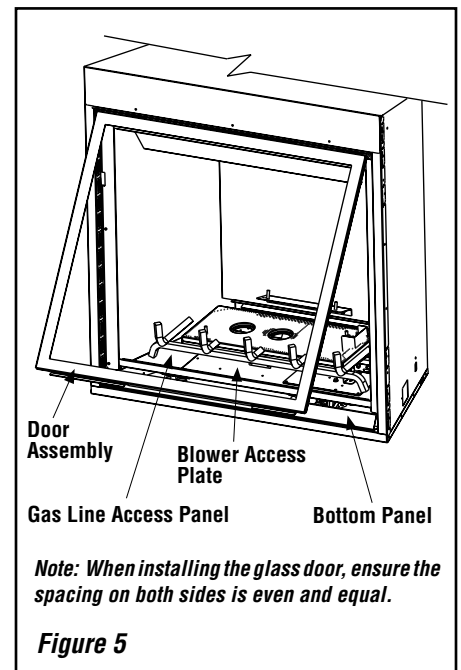

INSTALL VOLCANIC STONE, GLOWING EMBERS AND LOGS

NOTE: Turn off all electricity to the appliance before you install volcanic stone, embers and logs.

Loosen the set screw for the venturi air shutter. Manually actuate the air shutter through several cycles. Set the air shutter to 3/32" before placing the logs.

1. Remove the front glass enclosure panel (see *Removing and Installing Glass Enclosure Panels* on **Page 11**).

2. Remove log set box from firebox. Next, remove embers and volcanic stone from control compartment. **Handle logs carefully to prevent breakage.**

3. Install decorative volcanic stone - Sprinkle the decorative volcanic stone in a pleasing pattern (see **Figure 6**). The volcanic stone should be placed directly on top of the firebox bottom, along the slope and to the back at the right and left sides of the burner. Position any ceramic fiber liners before placing the stone. Logs can be positioned after the volcanic stone.

4. Placement of Glowing Embers - Separate the Embers (rockwool) into pieces about the size of a quarter (see **Figure 7**). Keep the pieces fluffed up, not matted. Distribute these pieces over the surface of the burner, as shown in **Figure 6**. Do not use more than is necessary. **Ensure that the main burner slots remain uncovered by the ember material.** Position the embers on the small holes of the ember bed area.

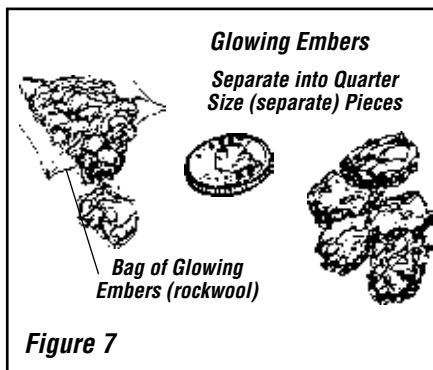

Note: This appliance is provided with enough Glowing Embers for several applications, do not use all that is in a new bag at one time. For best glowing effect, replace the ember material annually.

5. Placement of Logs -

All top logs that rest on lower logs, do so over notches, indents or nubs. Proper log placement is critical to prevent sooting. Logs should be placed in the gaps between the flame peaks and should be positioned so they do not impinge the flames. Follow the log placement instructions exactly.

Proper log and twig placement is critical to encourage outstanding flame appearance and prevent sooting.

These fires are designed to provide a rich orange/red glow on the logs. Rear log (2) placement is critical. An adjustment of one quarter of an inch can have significant effect on flame color and height. Pull rear log (2) forward as far as it will go on the pins.

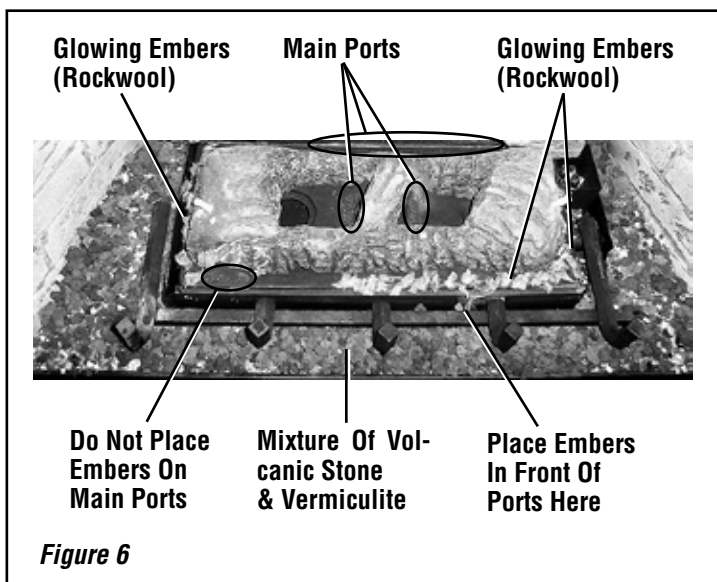

Note: The log set and fire are artistically arranged to provide a random asymmetric look to the fire. The fire *intentionally* does not burn in the left rear quarter of the log set.

For log placement instructions, refer to the detailed steps in **Figures 8, 9 and 10**.

REFERENCE Firebox Accessories / Parts		
Cat. No.	Model No.	Description
88L53	FGE	Bag of Glowing Embers
80L42	FDVS	Bag of Decorative Volcanic Stone

WARNING

- **DO NOT attempt to install the logs until the appliance installation has been completed, the gas line connected and tested for leaks and the initial burner operation has been checked out.**
- **The size and position of the log set was engineered to give the appliance a safe, reliable and attractive flame pattern. Any attempt to use a different log set in the fireplace will void the warranty and will result in incomplete combustion, sooting, and poor flame quality.**
- **Logs get very hot and will remain hot up to one hour after gas supply is turned off. Handle only when logs are cool. Turn off all electricity to the appliance before you install grate, volcanic stone, vermiculite, embers and logs.**
- **This appliance is not designed to burn wood. Any attempt to do so could cause irreparable damage to the appliance and prove hazardous to your safety.**
- **If logs are not installed according to the log installation instructions, flame impingement and improper combustion could occur and result in soot and/or excessive production of carbon monoxide (CO), a colorless, odorless, toxic gas.**

ELD V3530 LOG PLACEMENT

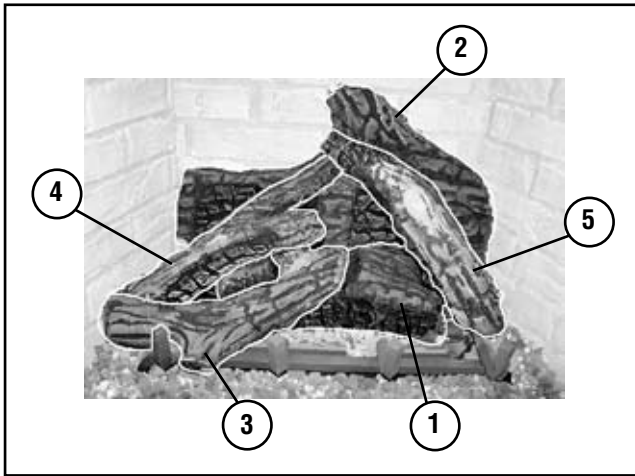

Log Number	Description
1	Log, Center
2	Log, Rear
3	Log, Front
4	Log, Left
5	Log, Right

Catalog Number for the entire log set: H4656

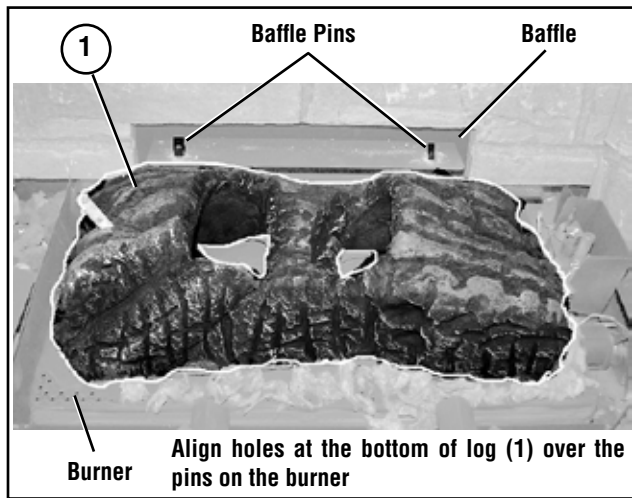

Step 1

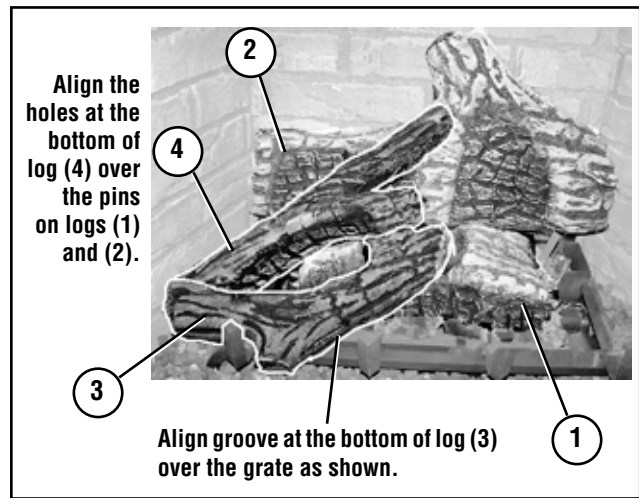

Step 3

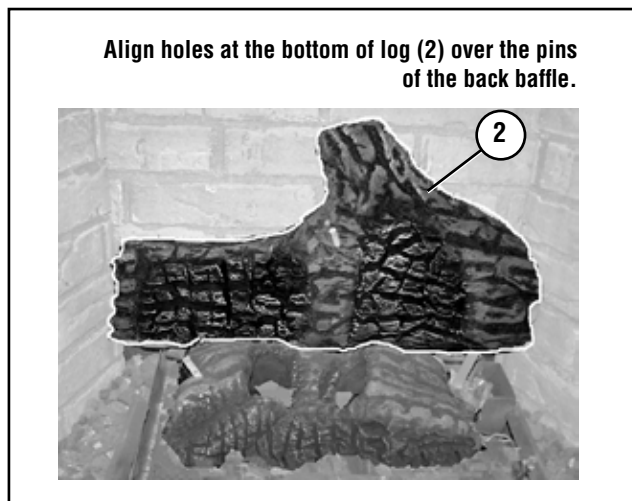

Step 2

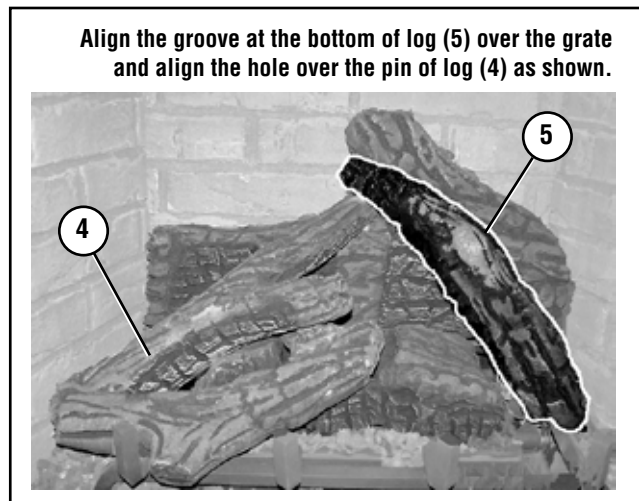

Step 4

Figure 8

ELD V4035 LOG PLACEMENT

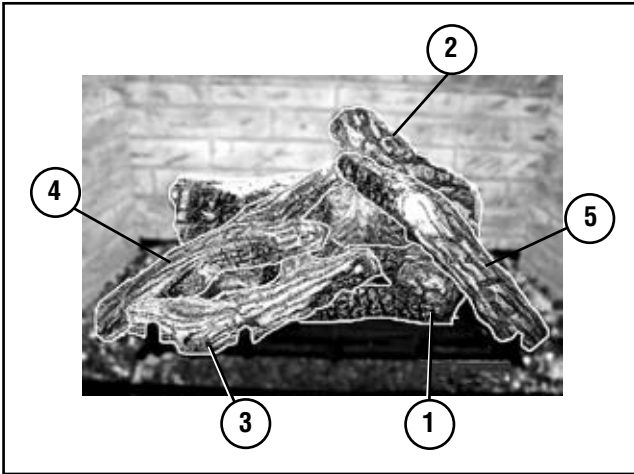

Log Number	Description
1	Log, Center
2	Log, Rear
3	Log, Front
4	Log, Left
5	Log, Right

Catalog Number for the entire log set: H4657

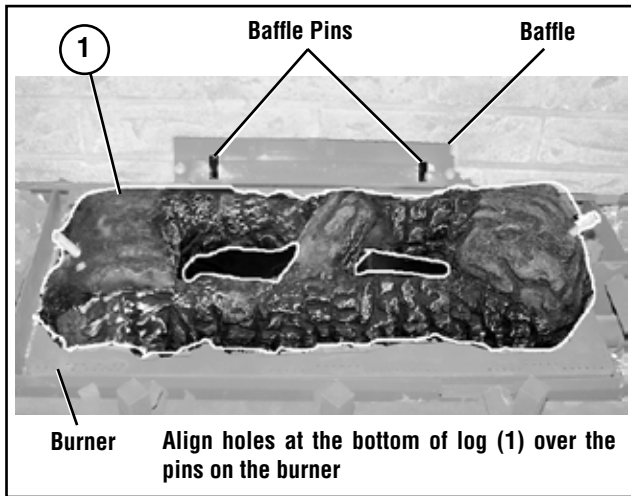

Step 1

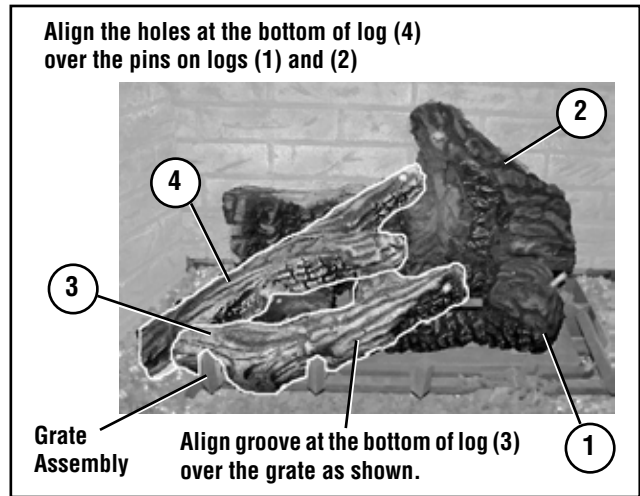

Step 3

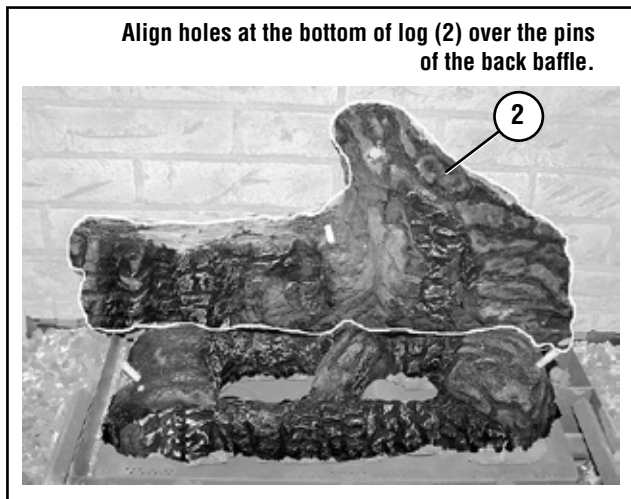

Step 2

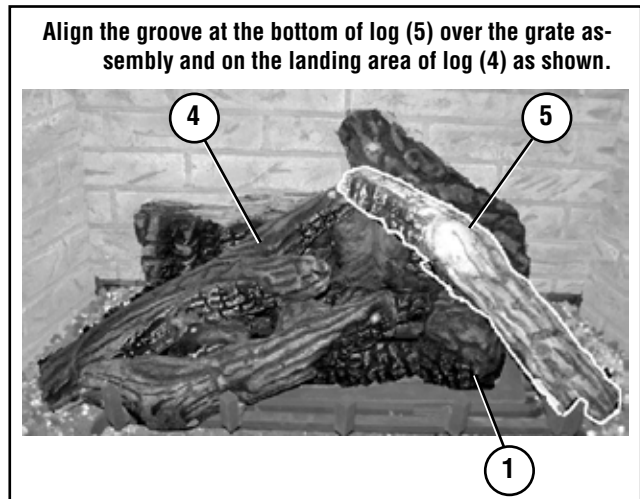

Step 4

Figure 9

ELDV4540 LOG PLACEMENT

(REPEAT STEPS 1 THRU 4 FROM ELDV4035 LOG PLACEMENT AND THEN ADD THE FOLLOWING STEPS)

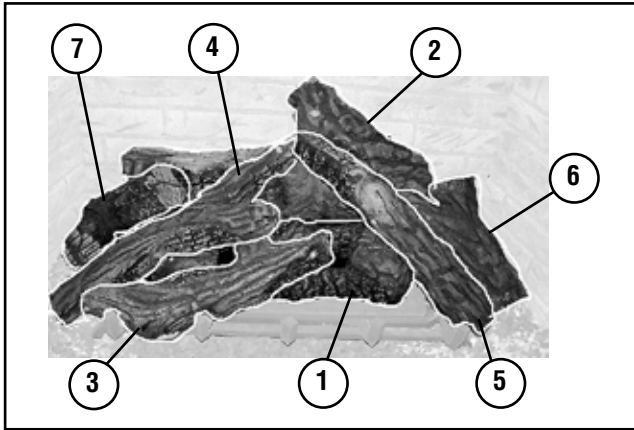

Log Number	Description
1	Log, Center
2	Log, Rear
3	Log, Front
4	Log, Left
5	Log, Right
6	Log, Right/Rear
7	Log, Left/Rear

Catalog Number for the entire log set: H4658

Place log (6) between log (2) and log (5) as shown

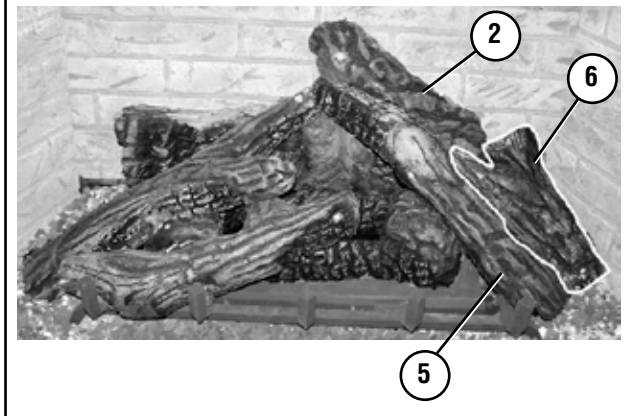

Step 5

Place log (7) over log (4) as shown

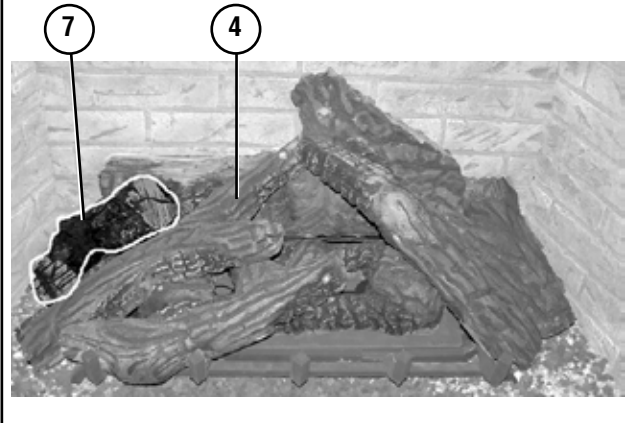

Step 6

Figure 10

**BURNER ADJUSTMENTS
(QUALIFIED TECHNICIANS ONLY)**

Flame Appearance and sooting

Proper flame appearance is a flame which is blue at the base and becomes yellowish-orange in the body of the flame. When the appliance is first lit, the entire flame may be blue and will gradually turn yellowish-orange during the first 15 minutes of operation. If after a short period the flame stays lowered blue, or if the flame is orange with evidence of sooting (black tip), the air shutter opening may need to be adjusted.

If the air shutter openings closed too far, sooting may develop. Sooting is indicated by black puffs developing at the tips of very long orange flames. Sooting results in black deposits forming on the logs, appliance inside surfaces and on exterior surfaces adjacent to the vent termination.

Sooting is caused by incomplete combustion in the flames and lack of combustion air entering the air shutter opening. To achieve a warm yellowish-orange flame with an orange body that does not soot, the shutter opening must be adjusted between these two extremes.

Air Shutter Adjustment Guidelines

- If there is smoke or soot present, first check the log set positioning to ensure that the flames are not impinging on any of the logs. If the log set is properly positioned and a sooting condition still exists, then the air shutter opening should be increased.
- The more offsets in the vent system, the larger the air shutter opening will need to be.
- An appliance operated with the air shutter opened too far, may have flames that appear blue and transparent. These weak, blue and transparent flames are termed anemic.
- Propane models may exhibit flames which candle or appear stringy. If this is present and persists, adjust the air shutter to a more open position, then operate the appliance for a few more minutes to ensure that the flame normalizes and the flames do not appear sooty.

The following chart is provided to aid you in achieving the correct air shutter adjustment for your installation.

Air Shutter Adjustment Guidelines:		
Amount of Primary Air	Flame Color	Air Shutter Adjustment
If air shutter is closed too far →	Flame will be orange →	Air shutter gap should be increased
If air shutter is open too far →	Flame will be blue →	Air shutter gap should be decreased



Figure 11 (Burner & Flame Appearance Model) ELDV35 (With Optional Brick Liner Kit)



Figure 12 (Burner & Flame Appearance Model) ELDV40 (With Optional Brick Liner Kit)



Figure 13 (Burner & Flame Appearance Model) ELDV45

Burner Air Shutter Adjustment Procedure

⚠ WARNINGS

- Air shutter adjustment should only be performed by a qualified professional service technician.
- Ensure front glass panel are in place and sealed during adjustment.

⚠ CAUTIONS

- Carbon will be produced if the air shutter is closed too much. Any damage due to carboning resulting from improperly setting the air shutter is not covered under the warranty.
- The air shutter door and nearby appliance surfaces are hot. Exercise caution to avoid injury while adjusting flame appearance.

1. Locate adjustment rod and adjust air shutter to the standard setting as shown in **Figure 14** (adjustment rod is located in the lower control compartment).

Note: Rotating the adjustment rod down to decrease air and up to increase air.

2. Light appliance (follow lighting procedure on lighting label in control compartment or see the lighting instructions, **Pages 22 and 24** in this manual).
3. Allow the burner to operate for at least 15 minutes while observing the flame continuously to ensure that the proper flame appearance has been achieved (see **Figures 11, 12 or 13**). If the following conditions are present, adjust accordingly.
 - If flame appears weak or sooty, adjust the air shutter, incrementally, to a more open position until the proper flame appearance is achieved.
 - If flame stays lowered blue, adjust the air shutter, incrementally, to a more closed position until the proper flame appearance is achieved.
4. Leave the control knob (off/pilot/on) in the ON position and the burner OFF/ON switch OFF (and remote switches, if applicable).
5. When satisfied that the burner flame appearance is normal, close the lower control compartment door (see **Figures 11, 12 and 13** on **Page 16**).

Burner Air Shutter Adjustment

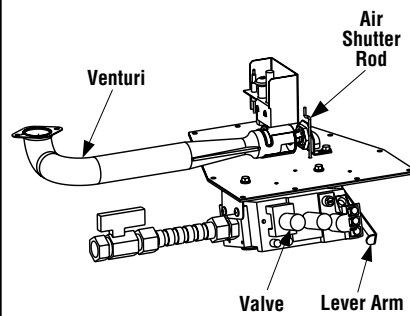

MAIN BURNER FACTORY SHUTTER OPENING SETTING

Models	Natural Gas inches (mm)	Propane Gas inches (mm)
ELD V35	1/8 (3.2)	3/8 (9.5)
ELD V40	1/4 (6.4)	7/16 (11.1)
ELD V45	1/4 (6.4)	7/16 (11.1)

Figure 14

Millivolt Appliance Checkout

The pilot flame should be steady, not lifting or floating. Flame should be blue in color with traces of orange at the outer edge.

The top 3/8" (10 mm) at the pilot generator (thermopile) and the top 1/8" minimum (tip) of the quick drop out thermocouple should be engulfed in the pilot flame. The flame should project 1" (25 mm) beyond the hood at all three ports (see **Figure 15**).

To light the burner, refer to the lighting instructions on **Page 22**.

SIT MILLIVOLT PILOT ASSEMBLY

Proper Pilot Flame Appearance

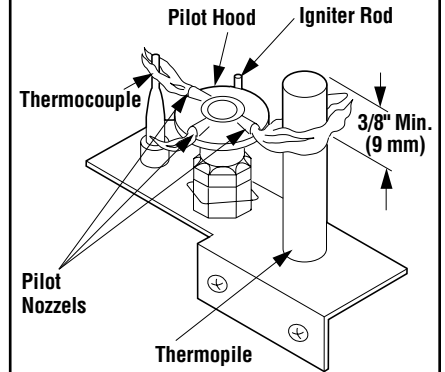
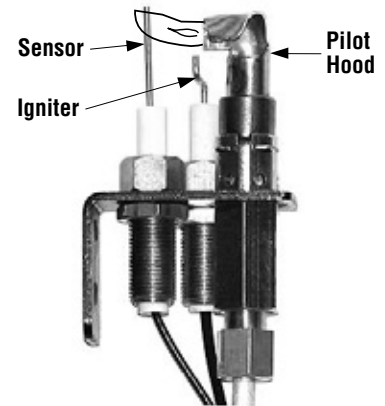

Figure 15

Electronic Appliance Checkout

To light the burner, refer to the lighting instructions on **Page 24**. Ensure the igniter lights the pilot. The pilot flame should engulf the flame sensor as shown in **Figure 16**.

ELECTRONIC PILOT ASSEMBLY



Note: If the igniter is damaged, a replacement kit is available, order **Catalog Number 87L54**.

Figure 16

WARRANTY

Your gas appliance is covered by a limited twenty year warranty. You will find a copy of the warranty accompanying this manual. Please read the warranty to be familiar with its coverage.

Retain this manual. File it with your other documents for future reference.

REPLACEMENT PARTS

A complete parts list is found at the end of this manual. Use only parts supplied from the manufacturer.

With proper care and maintenance, your appliance will provide many years of enjoyment. If you should experience any problem, first refer to the troubleshooting guide in this manual. If problem persists, contact your Lennox Hearth Products dealer or distributor.

Normally, all parts should be ordered through your Lennox Hearth Products distributor or dealer. Parts will be shipped at prevailing prices at time of order.

When ordering repair parts, always give the following information:

1. The model number of the appliance.
2. The serial number of the appliance.
3. The part number.
4. The description of the part.
5. The quantity required.
6. The installation date of the appliance.

If you encounter any problems or have any questions concerning the installation or application of this system, please contact your dealer or distributor.

LENNOX HEARTH PRODUCTS
 1508 Elm Hill Pike, Suite 108
 Nashville, TN 37210
 visit us at www.Lennox.com
 1-800-9-LENNOX

PRODUCT REFERENCE INFORMATION

We recommend that you record the following important information about your fireplace. Please call Lennox Hearth Products for the phone number of your nearest Lennox Hearth Products dealer who will answer your questions or address your concerns.

Your Fireplace's Model Number _____

Your Fireplace's Serial Number _____

The Date On Which Your Fireplace Was Installed _____

The Type of Gas Your Fireplace Uses _____

Your Dealer's Name _____

WIRING DIAGRAMS

Wiring diagrams are provided here for reference purposes only. This information is also provided on schematics attached directly to the appliance on a pullout panel located within the control compartment.

CAUTION: LABEL ALL WIRES PRIOR TO DISCONNECTION WHEN SERVICING CONTROLS. WIRING ERRORS CAN CAUSE IMPROPER AND DANGEROUS APPLIANCE OPERATION.

ATTENTION: AU MOMENT DE L'ENTRETIEN DES COMMANDES, ÉTIQUÉTEZ TOUS LES FILS AVANT DE LES DÉBRANCHER. DES ERREURS DE CÂBLAGE PEU-VENT ENTRAÎNER UN FONCTIONNEMENT INADÉQUAT ET DANGEREUX.

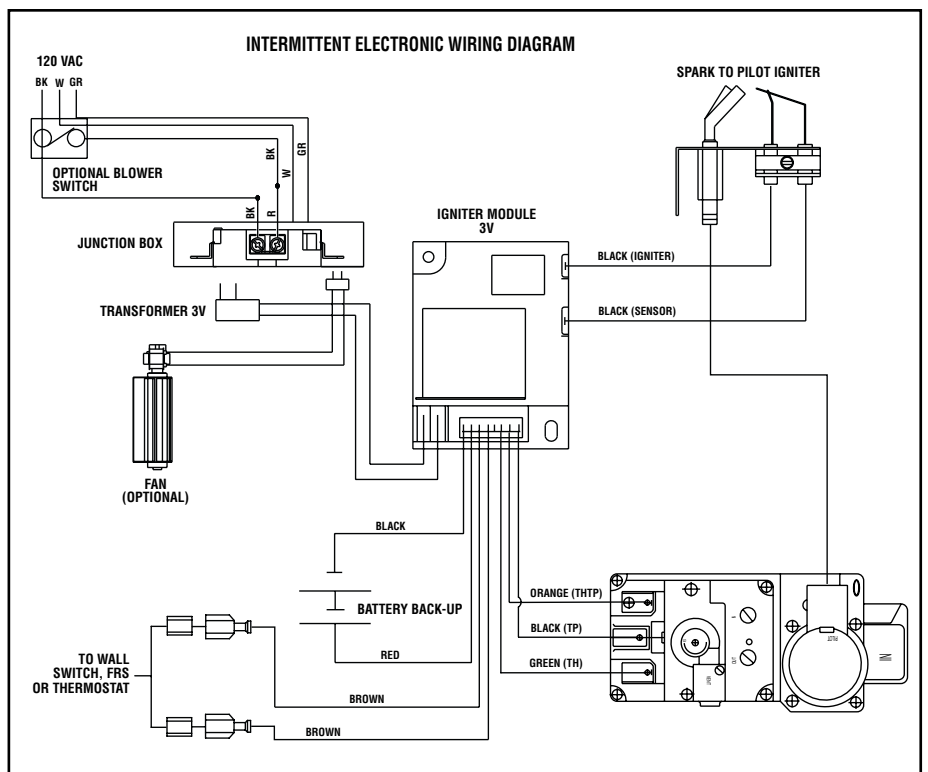
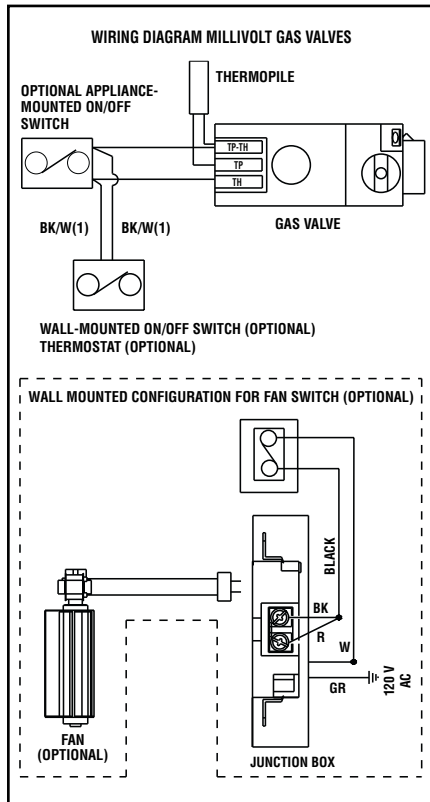

NOTE: DIAGRAMS & ILLUSTRATIONS ARE NOT TO SCALE.

ACCESSORY COMPONENTS

Product Reference Information			
Cat. No.	Model	Ship. Weight	Ship. Volume
H3948	ELDV-35NM	159 lb.	26.1 cu. ft.
H3949	ELDV-35PM	159 lb.	26.1 cu. ft.
H3950	ELDV-35NE	159 lb.	26.1 cu. ft.
H3951	ELDV-40NM	182 lb.	26.06 cu. ft.
H3952	ELDV-40PM	182 lb.	26.06 cu. ft.
H3953	ELDV-40NE	182 lb.	26.06 cu. ft.
H3954	ELDV-45NM	202 lb.	33.03 cu. ft.
H3955	ELDV-45PM	202 lb.	33.03 cu. ft.
H3956	ELDV-40NE	202 lb.	33.03 cu. ft.



Digital Wall Thermostat

The wall thermostat kit provides temperature control for optimum comfort.

Wall Thermostat, Millivolt		
Cat. No.	Model No.	Description
H4635	DWTK	Wall Thermostat Kit, White



Standard Remote Control System

The Model RCL (Standard) Remote Control System, features a simplistic OFF/ON control function for the fireplace. This model includes a hand-held transmitter, a remote receiver with wall-mount cover plate and all hardware required to install the unit. The remote receiver can be wall or hearth mounted.

The transmitter has ON and OFF functions that are activated by pressing either button on the face of the transmitter. When a button on the transmitter is pressed, a signal light illuminates briefly to verify that a signal has been sent.

The Model RCL is designed to operate with all millivolt ignition systems, as well as electronic ignition systems. It may be installed with use for either natural gas or propane gas appliances. The RCL offers ease of installation and allows you to execute on-off commands to the fireplace effortlessly with one simple motion.

The Model RCL comes complete with detailed operating instructions.

Remote Control Kit, Standard		
Cat. No.	Model No.	Description
H0249	RCL	Remote Control System (Standard)



Deluxe Remote Control System

The Model RCL-T (Deluxe) Remote Control System has all of the features of the standard system along with an added easy to read LCD screen which presents access to many enhancements, including; battery power level indicator, timer, mode of operation, thermostatic display including room temperature in either metric or English units, flame indicator and clock. Fully programmable, the Model RCL-T allows for virtual command over nearly all operational and temperature variables, using the hand held remote control transmitter.

The Model RCL-T (Deluxe) remote control system is installed in the same manner as the standard system, may be operated with electronic and millivolt systems with either natural gas or propane gas. The RCL-T comes complete with detailed operating instructions.

Remote Control Kit, Deluxe		
Cat. No.	Model No.	Description
H0251	RCL-STAT	Remote Control System (Deluxe)

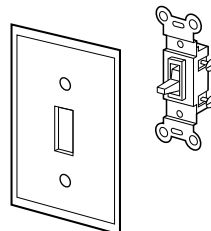

OFF/ON Wall Switch Kit

The OFF/ON wall switch kit may be used to control the operation of the fireplace burner or blower. Install the OFF/ON wall switch in a convenient location near the fireplace.

White Wall Switch Kit		
Cat. No.	Model No.	Description
85L87	FWSK	OFF/ON Wall Switch Kit

NOTE: DIAGRAMS & ILLUSTRATIONS ARE NOT TO SCALE.

ACCESSORY COMPONENTS CONTINUED

Style View Doors -

Style View Doors come in 2 beautiful styles. They are easy to install and will not require hardware to attach them to the standard glass door frame. The door includes heavy duty magnet door latches and functional twin-pane doors.

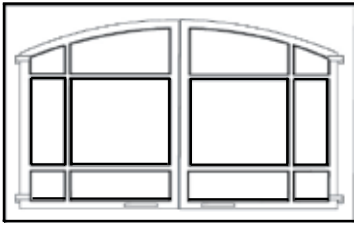

Arch Pane Design

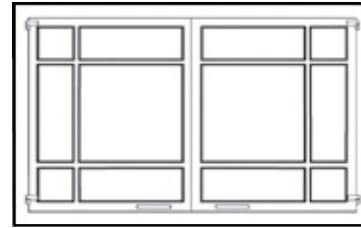

Square Pane Design

ARCH PANE DESIGN KITS			
Cat. No.	Model	Description	Model Series
H3973	APDL40C	40" Arch Doors, Charcoal	ELDV40
H3974	APDL40SP	40" Arch Doors, Satin Pewter	
H3975	APDL40AB	40" Arch Doors, Antique Brass	
H3976	APDL45C	45" Arch Doors, Charcoal	ELDV45
H3977	APDL45SP	45" Arch Doors, Satin Pewter	
H3978	APDL45AB	45" Arch Doors, Antique Brass	
H3970	APDL35C	35" Arch Doors, Charcoal	ELDV35
H3971	APDL35SP	35" Arch Doors, Satin Pewter	
H3972	APDL35AB	35" Arch Doors, Antique Brass	

SQUARE PANE DESIGN KITS			
Cat. No.	Model	Description	Model Series
H3982	SPDL40C	40" Sq. Doors, Charcoal	ELDV40
H3983	SPDL40SP	40" Sq. Doors, Satin Pewter	
H3984	SPDL40AB	40" Sq. Doors, Antique Brass	
H3985	SPDL45C	45" Sq. Doors, Charcoal	ELDV45
H3986	SPDL45SP	45" Sq. Doors, Satin Pewter	
H3987	SPDL45AB	45" Sq. Doors, Antique Brass	
H3979	SPDL35C	35" Sq. Doors, Charcoal	ELDV35
H3980	SPDL35SP	35" Sq. Doors, Satin Pewter	
H3981	SPDL35AB	35" Sq. Doors, Antique Brass	

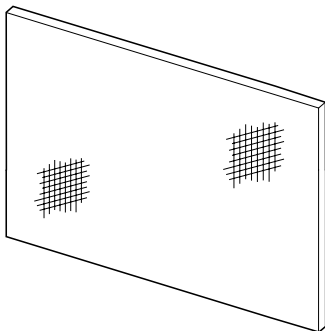

Screen Panel Kits	
Model No.	Catalog No. Model No.
ELDV35	H3988 35LSPK
ELDV40	H3989 40LSPK
ELDV45	H3990 45LSPK

These screen panels can be installed on the glass enclosure panel to provide a barrier preventing direct contact with hot glass. The screen panel kits cannot be used in conjunction with either of the arch door kits or door frame kits.

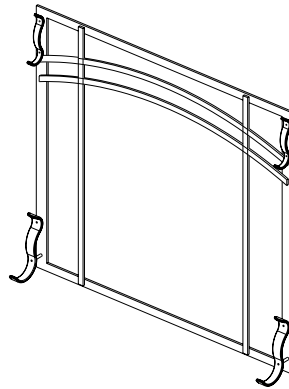

Dual Arch Screen Kits	
Model No.	Catalog No. Model No.
ELDV35	H4688 DASK-DV35
ELDV40	H4689 DASK-DV40
ELDV45	H4690 DASK-DV45

These screen kits can be installed on the glass enclosure panel to provided protection from the hot glass surface.

ACCESSORY COMPONENTS CONTINUED

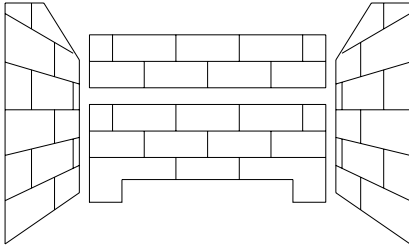

Brick Liner Kits		
Model No.	Catalog No. Model No.	Description
ELDV35	H3961 BLKR-ELDV35	Rustic
ELDV35	H3962 BLKH-ELDV35	Herringbone
ELDV35	H3963 BLKC-ELDV35	Red Old Cottage
ELDV35	H4708 BLKBR-ELDV35	Boston Red
ELDV40	H3964 BLKR-ELDV40	Rustic
ELDV40	H3965 BLKH-ELDV40	Herringbone
ELDV40	H3966 BLKC-ELDV40	Red Old Cottage
ELDV40	H4709 BLKBR-ELDV40	Boston Red
ELDV45	H3967 BLKR-ELDV45	Rustic
ELDV45	H3968 BLKH-ELDV45	Herringbone
ELDV45	H3969 BLKC-ELDV45	Red Old Cottage
ELDV45	H4710 BLKBR-ELDV45	Boston Red

The brick panel liner kits include ceramic panels of the side walls, the rear and the baffle of the firebox. The panels have brick-like features in relief.

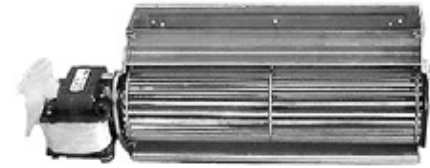

**Forced Air Blower Kit
Single Speed** H4678 LBLK-100

Forced Air Kit

The LBLK-100 blower provides constant velocity forced air circulation.



Touch-Up Paint (Black) Kit 70K99 FTPK-B

Touch-Up Paint Kit

Repair of minor scratches and discoloration of the appliance charcoal painted surfaces may be accomplished with the touch-up paint kit.

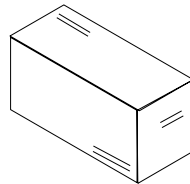

**Pine Cones and
Wood Bits** 91L05 FPCK

Twelve Piece Ember Kit

A twelve piece ember kit (model FPCK) has been developed to provide a means of enhancing the already impressive log presentation of this fireplace. This kit contains three (3) ceramic fiber pine cones and nine (9) ceramic fiber debris wood bits. All twelve elements will not be consumed in the flames and may be placed within the presentation area (without impinging any of the lofting flames) to add realism and enhance the rustic look and appeal of the fire.



**Bag of Glowing Embers
Bag of Volcanic Stone**

Replacement ember materials or volcanic stone are available for use with these appliances. Order kits as part of the periodic maintenance of the appliance.

Decorative Firebox Accessories (all models)		
Cat. No.	Model No.	Description
88L53	FGE	Bag of Glowing Embers
80L42	FDVS	Bag of Decorative Volcanic Stone

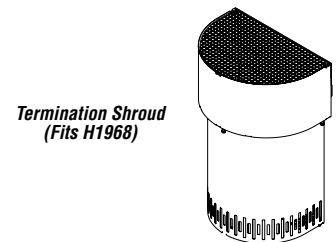

**Termination Shroud
(Fits H1968)**

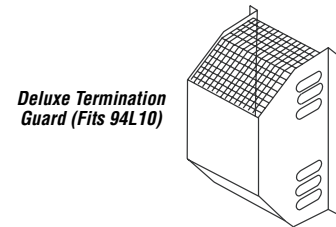

**Deluxe Termination
Guard (Fits 94L10)**

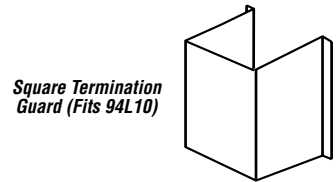

**Square Termination
Guard (Fits 94L10)**

Termination Guard Kits

The vent termination guards may be used to cover the vent termination on the exterior of the home to minimize exposure to the hot surface of the termination.

Termination Guard Kits (all models)		
Cat. No.	Model No.	Description
H5820	4.5HTSK	Termination Shroud
87L02	SV4.5HGS	Termination Guard, Deluxe
17M52	SV4.5HGS-1	Termination Guard, Square

NOTE: DIAGRAMS & ILLUSTRATIONS ARE NOT TO SCALE.

LIGHTING INSTRUCTIONS – MILLIVOLT GAS VALVE

FOR YOUR SAFETY READ BEFORE LIGHTING

WARNING: IF YOU DO NOT FOLLOW THESE INSTRUCTIONS EXACTLY, A FIRE OR EXPLOSION MAY RESULT CAUSING PROPERTY DAMAGE, PERSONAL INJURY OR LOSS OF LIFE.

- A.** This appliance has a pilot which must be lighted with a piezo igniter. When lighting the pilot, follow these instructions exactly.
- B. BEFORE OPERATING** smell all around the appliance area for gas. Be sure to smell next to the floor because some gas is heavier than air and will settle on the floor.

WHAT TO DO IF YOU SMELL GAS

- Extinguish any open flame.
- Open windows.
- Do not light any appliance.
- Do not touch any electrical switches.



- Do not use any phone in your building.
 - Immediately call your gas supplier from a neighbor's phone.
 - If your gas supplier cannot be reached, call the fire department.
- C.** Use only your hand to push in or turn the gas control knob. Never use tools. If the knob will not push in or turn by hand, do not try to repair it, call a qualified service technician. Force or attempted repair may result in a fire or an explosion.
- D.** Do not use this appliance if any part has been under water. Immediately call a qualified service technician to inspect the appliance and to replace any part of the control system and any gas control which has been under water.

LIGHTING INSTRUCTIONS

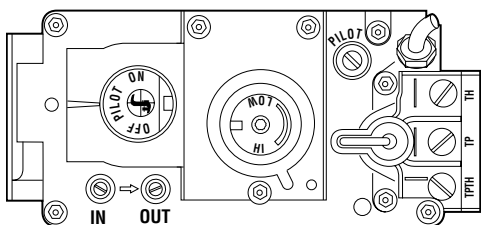
- 1. STOP!** Read the safety information above on this page.
2. Access the lower control compartment.
3. Turn remote wall switch to "OFF."
4. Verify main line shut-off valve is open.
5. Push in gas control knob slightly and turn clockwise to "OFF."



Note: Knob cannot be turned from "PILOT" to "OFF" unless the knob is pushed in slightly. Do not force.

6. Wait five (5) minutes to clear out any gas. If you then smell gas, STOP! Follow "B" in the safety information above on this page. If you do not smell gas, go to the next step.
 7. Push in gas control knob slightly and turn counterclockwise to "PILOT."
- 
8. Push in control knob all the way and hold in. Immediately light the pilot by triggering the spark igniter (pushing the button) until pilot lights. Continue to hold the control knob in for about 1-1/2 minutes after the pilot is lit. Release knob and it will pop back up. Pilot should remain lit. If it goes out, repeat steps 5 through 8.
- If knob does not pop up when released, stop and immediately call your service technician or gas supplier.
 - If pilot will not stay lit after several tries, turn the control knob to "OFF" and call your service technician or gas supplier.
9. Turn gas control knob counterclockwise to "ON."
- 
10. Close lower control compartment.

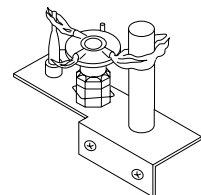

TO TURN OFF GAS TO APPLIANCE

1. Turn remote wall switch "OFF." The pilot will remain lit for normal service.
 2. For complete shutdown, turn remote wall switch to "OFF."
 3. Access the lower control compartment.
 4. Depress gas control knob slightly and turn clockwise to "OFF." Do not force.
- 
5. Close lower control compartment.

INSTRUCTIONS D'ALLUMAGE – VANNE GAZ MILLIVOLT

POUR VOTRE SÉCURITÉ, LISEZ CES INSTRUCTIONS AVANT L'ALLUMAGE

AVERTISSEMENT : SI VOUS NE SUIVEZ PAS CES INSTRUCTIONS À LA LETTRE, IL POURRAIT S'EN SUIVRE UN INCENDIE OU UNE EXPLOSION CAUSANT DES DOMMAGES MATÉRIELS, DES BLESSURES CORPORELLES OU MÊME DES PERTES DE VIE.

- A.** Cet appareil est muni d'une veilleuse qui doit être allumée avec un allumeur piézo-électrique. Lorsque vous allumez la veilleuse, suivre exactement ces instructions.
- B. AVANT L'ALLUMAGE:** Assurez-vous que vous ne détectez aucune odeur de gaz autour de l'appareil ainsi que près du sol; certains gaz, étant plus lourds que l'air, descendent au niveau du sol.
VOICI CE QUE VOUS DEVEZ FAIRE SI VOUS DÉCELEZ UNE ODEUR DE GAZ:
- Éteignez toute flamme visible.
 - Ouvrez les fenêtres.
 - N'allumez aucun appareil.
 - Ne touchez à aucun commutateur électrique.
 - Ne vous servez d'aucun téléphone dans votre édifice.
- Appelez immédiatement votre compagnie de gaz en utilisant le téléphone du voisin.
 - S'il vous est impossible de contacter votre compagnie de gaz, appelez le service des incendies.
- C.** N'utilisez que votre main pour manipuler le bouton de réglage du gaz. N'utilisez jamais d'outils. Si le bouton refuse de tourner ou de bouger, n'essayez pas de le réparer. Communiquez immédiatement avec un technicien de service qualifié. Toute tentative pour le forcer ou le réparer, risquerait de provoquer un incendie ou une explosion.
- D.** Ne vous servez pas de cet appareil si l'un de ses éléments a été immergé dans l'eau. Appelez immédiatement un technicien compétent pour faire inspecter l'appareil et remplacer toute pièce du système de réglage ou commande du gaz qui a été sous l'eau.

INSTRUCTIONS D'ALLUMAGE

1. **ARRÊTEZ!** Lisez les consignes de sécurité au verso de cette plaque.
2. Ouvrez le compartiment de contrôle du bas.
3. Tournez l'interrupteur mural à la position d'arrêt "OFF".
4. Assurez-vous que la soupape d'arrêt de la canalisation principale est ouverte.
5. Enfoncez légèrement le bouton de réglage du gaz et tournez-le dans le sens des aiguilles d'une montre jusqu'à la position d'arrêt "OFF".

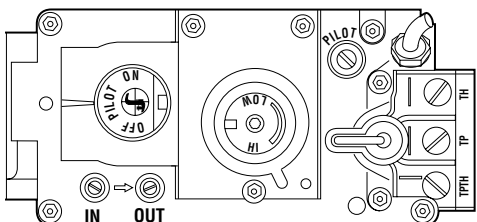

Remarque: Il est impossible de tourner le bouton de "PILOT" à "OFF" à moins qu'il ne soit légèrement enfoncé. Ne le forcez pas.

6. Attendez cinq (5) minutes pour l'évacuation du gaz. Si vous décelez une odeur de gaz, ARRÊTEZ ! Retournez au point "B" des consignes de sécurité au verso de cette plaque. Si vous ne remarquez aucune odeur de gaz, passez à l'étape suivante.
7. Enfoncez légèrement le bouton de réglage du gaz et tournez-le en sens inverse des aiguilles d'une montre jusqu'à la position de veilleuse "PILOT".

8. Enfoncez le bouton de réglage jusqu'au fond et gardez-le enfoncé. Allumez immédiatement la veilleuse en déclenchant l'allume-gaz à étincelle (en poussant le bouton) jusqu'à ce que la veilleuse s'enflamme. Continuez de tenir le bouton de réglage enfoncé pendant environ 90 secondes après l'allumage de la veilleuse. Relâchez le bouton et il sortira subitement. La veilleuse devrait rester allumée. Si elle s'éteint, répétez les étapes 5 à 8 inclusivement.

- Si le bouton ne sort pas automatiquement après avoir été relâché, arrêtez immédiatement et téléphonez à votre technicien de service ou à votre fournisseur de gaz.

- Si la veilleuse refuse de rester allumée après plusieurs tentatives, tournez le bouton de réglage jusqu'à sa position d'arrêt "OFF" et téléphonez à votre technicien de service ou à votre fournisseur de gaz.

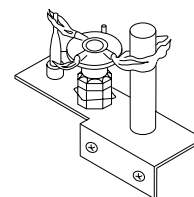

9. Tournez le bouton de réglage du gaz en sens inverse des aiguilles d'une montre jusqu'à sa position de marche "ON".
10. Fermez le compartiment de contrôle du bas.
11. Au besoin, rebrancher l'appareil au courant électrique et remettre l'interrupteur du brûleur principal à la position "ON" ou régler le thermostat à la température désirée.
12. Si l'appareil ne fonctionne pas, suivre les instructions intitulées "Pour fermer le gaz qui alimente l'appareil" et appeler un technicien ou le fournisseur de gaz.

POUR FERMER LE GAZ QUI ALIMENTE L'APPAREIL

1. Tournez l'interrupteur mural à la position d'arrêt "OFF". La veilleuse restera allumée jusqu'au retour du service normal.
2. Pour une fermeture complète, tournez l'interrupteur mural à la position d'arrêt "OFF".
3. Ouvrez le compartiment de contrôle du bas.
4. Enfoncez légèrement le bouton de réglage du gaz et tournez-le dans le sens des aiguilles d'une montre jusqu'à la position d'arrêt "OFF". Ne forcez pas le bouton.
5. Fermez le compartiment de contrôle du bas.

LIGHTING INSTRUCTIONS — ELECTRONIC

FOR YOUR SAFETY READ BEFORE LIGHTING

WARNING: IF YOU DO NOT FOLLOW THESE INSTRUCTIONS EXACTLY, A FIRE OR EXPLOSION MAY RESULT CAUSING PROPERTY DAMAGE, PERSONAL INJURY OR LOSS OF LIFE.

- A.** When lighting the appliance, follow these instructions exactly.
- B. BEFORE OPERATING** smell all around the appliance area for gas. Be sure to smell next to the floor because some gas is heavier than air and will settle on the floor.
- Do not use any phone in your building.
 - Immediately call your gas supplier from a neighbor's phone.
 - If your gas supplier cannot be reached, call the fire department.

WHAT TO DO IF YOU SMELL GAS

- Extinguish any open flame.
- Open windows.
- Do not light any appliance.
- Do not touch any electrical switches.

- C.** Do not use this appliance if any part has been under water. Immediately call a qualified service technician to inspect the appliance and to replace any part of the control system and any gas control which has been under water.

LIGHTING INSTRUCTIONS

1. **STOP!** Read the safety information above on this page.
2. Turn remote wall switch to "OFF" or set wall thermostat to lowest setting. If used, remove the batteries from the battery holder.
3. This appliance is equipped with an ignition device which automatically lights the pilot. Do not try to light the pilot by hand.
4. Push the unit mounted "ON/OFF" switch to the "OFF" position.

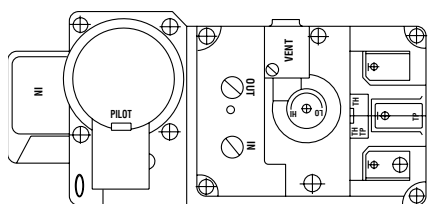

5. Allow sufficient length of time (minimum 5 minutes) for any gas in the combustion chamber to escape. If you still smell gas, **STOP!** Follow "B" in the safety information above on this page. If you do not smell gas, go to the next step.

6. Push the unit mounted "ON/OFF" switch back to the "ON" position. (The "ON/OFF" switch may include a wall switch if so equipped). Replace the batteries in the battery holder, if used. If the burner does not light or stay lit after several tries, turn the unit mounted "ON/OFF" switch to the "OFF" position and call your service technician or gas supplier. **NOTE:** Sufficient time must be allowed for air to escape from lines if the unit is being lit for the first time.
7. Turn HI-LO burner control knob to desired setting and close control door.
8. Set thermostat to desired setting if applicable.
9. If the appliance will not operate, follow the instructions "To Turn Off Gas To Appliance" and call your service technician or gas supplier.



TO SHUT OFF

1. Turn off all electrical power to the appliance (remote wall switch) or set the thermostat to the lowest setting, if applicable. Or remove batteries, if used.

TO TURN OFF GAS TO APPLIANCE

1. For complete shut-down, turn remote wall switch to "OFF" or set the thermostat to the lowest setting, if applicable.
2. Turn the ON/OFF switch to "OFF". If step 1 is not applicable.
3. Turn off all electric power to the appliance and remove backup batteries if service is to be performed or for extended shutdown.

INSTRUCTIONS D'ALLUMAGE — ELECTRONIC

POUR VOTRE SÉCURITÉ, LISEZ CES INSTRUCTIONS AVANT L'ALLUMAGE

AVERTISSEMENT: SI VOUS NE SUIVEZ PAS CES INSTRUCTIONS À LA LETTRE, IL POURRAIT S'EN SUIVRE UN INCENDIE OU UNE EXPLOSION CAUSANT DES DOMMAGES MATÉRIELS, DES BLESSURES CORPORELLES OU MÊME DES PERTES DE VIE.

- A.** Lorsque vous allumez l'appareil, suivez exactement ces instructions.
- B. AVANT L'ALLUMAGE:** Assurez-vous que vous ne détectez aucune odeur de gaz autour de l'appareil ainsi que près du sol; certains gaz, étant plus lourds que l'air, descendent au niveau du sol.
- VOICI CE QUE VOUS DEVEZ FAIRE SI VOUS DÉCELEZ UNE ODEUR DE GAZ**
- Éteignez toute flamme visible.
 - Ouvrez les fenêtres.
 - N'allumez aucun appareil.
- Ne touchez à aucun commutateur électrique.
 - Ne vous servez d'aucun téléphone dans votre édifice.
 - Appelez immédiatement votre compagnie de gaz en utilisant le téléphone du voisin.
 - S'il vous est impossible de contacter votre compagnie de gaz, appelez le service des incendies.
- C.** Ne vous servez pas de cet appareil si l'un de ses éléments a été immergé dans l'eau. Appelez immédiatement un technicien compétent pour faire inspecter l'appareil et remplacer toute pièce du système de réglage ou commande du gaz qui a été sous l'eau.

INSTRUCTIONS D'ALLUMAGE

- 1. ARRÊTEZ !** Lisez les consignes de sécurité au verso de cette plaque.
2. Tournez l'interrupteur mural à la position d'arrêt "OFF".
3. Ouvrez la porte du compartiment de contrôle du bas.
4. Assurez-vous que la soupape d'arrêt de la canalisation principale est ouverte.
5. Tournez la manette de réglage du gaz à la position d'arrêt "OFF".
6. Attendez cinq (5) minutes pour l'évacuation du gaz. Si vous décelez une odeur de gaz **ARRÊTEZ !** Retournez au point "B" des consignes de sécurité au verso de cette plaque.
7. Tournez la manette de réglage du gaz jusqu'à la position de marche "ON". Ne la forcez pas.
8. Ouvrez le courant électrique ("ON") qui alimente l'appareil (interrupteur mural).
9. Fermez la porte du compartiment de contrôle du bas.
10. Au besoin, rebranchez l'appareil au courant électrique et remettez l'interrupteur principal du brûleur à la position "ON" ou réglez le thermostat à la température désirée.
11. Si l'appareil ne se met pas en marche, suivez les instructions intitulées "Pour fermer le gaz qui alimente l'appareil" et appelez un technicien ou le fournisseur de gaz.

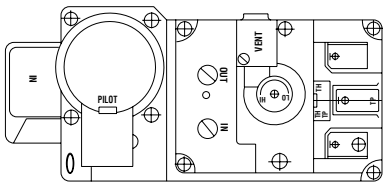

POUR ÉTEINDRE L'APPAREIL

1. Pour une fermeture complète, tournez l'interrupteur mural à la position d'arrêt "OFF".
2. Ouvrez la porte du compartiment de contrôle du bas.
3. Tournez la manette de réglage du gaz à la position d'arrêt "OFF". Ne la forcez pas.
4. Fermez la soupape d'arrêt de la canalisation principale.
5. Fermez la porte du compartiment de contrôle du bas.

MAINTENANCE SCHEDULE

Annually (Before the onset of the Burning Season)

MAINTENANCE TASK	ACCOMPLISHING PERSON	PROCEDURE
Inspecting/Cleaning Burner, Logs and Controls	Qualified Service Technician	Inspect valve and ensure it is properly operating. Check piping for leaks. Vacuum the control compartment, fireplace logs and burner area.
Check Flame Patterns and Flame Height	Qualified Service Technician	Refer to Figures 8 through 10 on Pages 13 through 15 and verify the flame pattern and height displayed by the appliance conforms to the picture. Flames must not impinge on the logs. Ensure flames are steady (not lifting or floating).
Inspecting/Cleaning Pilot and Burner	Qualified Service Technician	Refer to Figure 15 (SIT Millivolt) or Figure 16 (Electronic) on Page 17 . Remove any surface build-up on pilot and burner assembly. Wipe the pilot nozzles, igniter/flame rod and hood. Ensure the pilot flame engulfs the flame sensor as shown.
Checking Vent System	Qualified Service Technician	Inspect the vent system at the top and at the base (within the firebox) for signs of blockage or obstruction. Look for any signs of dislocation or deterioration of the vent components. Note: <i>Excessive condensation can cause corrosion of caps, pipe and fittings (excessive condensation can be caused by long lateral runs, too many elbows and/or exterior portions of the system being exposed to cold weather). Also inspect wall straps or plumbers's tape to ensure it is secure and in place.</i>
Appliance Checkout	Qualified Service Technician	Perform the appropriate appliance checkout procedure detailed in this manual.
Replacing Rockwool Ember Materials	Homeowner/Qualified Service Technician	Remove old ember materials (rockwool) and vacuum the ember placement area. Place new embers as described and shown in Figures 6 and 7 .

Periodically (After the Burning Season)

MAINTENANCE TASK	ACCOMPLISHING PERSON	PROCEDURE
Cleaning Firebox Interior	Homeowner	Carefully remove logs, rockwool and volcanic stone. Vacuum out interior of the firebox. Clean firebox walls and log grate. Replace logs, rockwool, and volcanic stone as detailed in this manual.
Check Flame Patterns and Flame Height	Homeowner	Refer to Figures 8 through 10 on Pages 13 through 15 and verify the flame pattern and height displayed by the appliance conforms to the picture. Flames must not impinge on the logs.
Checking Vent System	Homeowner	Inspect the vent system at the top and at the base (within the firebox) for signs of blockage or obstruction. Look for any signs of dislocation of the vent components.
Cleaning Front Glass Enclosure Panel	Homeowner	Clean as necessary following the directions provided in this manual. DO NOT TOUCH OR ATTEMPT TO CLEAN GLASS WHILE HOT.

TROUBLESHOOTING THE MILLIVOLT CONTROL SYSTEM

Note: Before troubleshooting the gas control system, Ensure external gas shut off valve, located at gas supply inlet, (and wall switch, iff applicable), is in the "ON" position.

Important: Valve system troubleshooting should only be accomplished by a qualified service technician.

SYMPTOM	POSSIBLE CAUSES	CORRECTIVE ACTION
<p>1. Spark igniter will not light pilot after repeated triggering of igniter button.</p> <p>WARNING: if the pilot will not light after 1 minute of attempting, wait for at least 5 minutes for gas to clear before attempting again.</p>	<p>A. Defective igniter (no spark at electrode).</p>	<p>Check for spark at electrode and pilot; if no spark and electrode wire is properly connected, replace igniter.</p>
	<p>B. Defective or misaligned electrode at pilot (spark at electrode).</p>	<p>Using a match, light pilot. If pilot lights, turn off pilot and trigger the igniter button again. If pilot lights, an improper gas mixture caused the bad lighting and a longer purge period is recommended. If pilot will not light – check gap at electrode and pilot – should be 1/8" to have a strong spark. If gap measures 1/8", replace pilot (see Figure 15 on Page 17).</p>
	<p>C. Gas supply pressure errant.</p>	<p>Check inlet gas pressure. It should be within the limits as marked on the rating plate.</p>
	<p>D. Pilot orifice plugged.</p>	<p>Clean or replace pilot orifice.</p>
<p>2. Pilot will not stay lit after carefully following the lighting instructions.</p>	<p>A. Defective pilot generator (thermocouple).</p>	<p>Check pilot flame, it must impinge on thermocouple (see Figure 15 on Page 17). Clean and/or adjust pilot for maximum flame impingement on thermocouple. Ensure that the connection between the valve and thermocouple are tight and secure.</p>
<p>3. Pilot burning, no gas to burner, Valve knob "ON," and the (standard) burner OFF/ON switch is "ON." Read important note below.</p> <p>IMPORTANT NOTE: If an optional *remote switch is used for burner operation, if the standard burner OFF/ON switch is still installed on appliance it must be in the "OFF" position.</p> <p>* Optional remote switch kits - wall switch, wall thermostat or remote control.</p>	<p>A. Wall switch or wires defective.</p>	<p>Check wall switch and wires for proper connections. Jumper wire across terminals at wall switch, if burner comes on, replace defective wall switch. If okay, jumper wires across wall switch wires at valve, if burner comes on, wires are faulty or connections are bad.</p>
	<p>B. Thermopile may not be generating sufficient millivolts.</p>	<p>Check thermopile with millivolt meter. Take reading at thermopile terminals of gas valve. Should read 325 millivolts minimum with optional wall switch "OFF." Replace faulty thermopile if reading is below specified minimum.</p>
	<p>C. Plugged burner orifice.</p>	<p>Check burner orifice for blockage and remove.</p>
	<p>D. OFF/ON Switch and *Remote Switch are in the "ON" position resulting in excessive resistance.</p>	<p>When turning on the burner using a *remote switch, ensure that the standard OFF/ON switch is in the "OFF" position. If both switches are in the ON position, it may result in excessive resistance (and millivolt drainage) and the burner may not come on.</p>
<p>4. Frequent pilot/burner outage problem.</p>	<p>A. Pilot flame may be too low or blowing (high) causing the pilot/valve safety to drop out.</p>	<p>Clean and/or adjust pilot flame for maximum flame impingement on thermocouple (see Figure 15 on Page 17).</p>

TROUBLESHOOTING THE ELECTRONIC IGNITION SYSTEM

Note: Before troubleshooting, be sure that the appliance main line gas shut-off valve, the gas control valve and the wall switch are in the "ON" position.

Important: Valve system troubleshooting should only be accomplished by a qualified service technician.

SYMPTOM	POSSIBLE CAUSES	CORRECTIVE ACTION
1. Nothing happens when ON/OFF switch is turned on (pilot does not spark).	A. Low voltage/or bad lead wires.	Check voltage on AC terminals of module an/or batteries. The value should be around 2.7 to 3.2 VAC. Confirm that wire connections are secure.
	B. Damaged igniter wire.	Check for visible cracked casing, cuts, etc.
	C. Damaged pilot assembly.	Check pilot assembly for visibly broken spark electrode, etc.
	D. Batteries Low	Check voltage on D.C. terminal of batteries. The value should be around 3.0V
2. The main burner does not light and the igniter is sparking.	A. No fuel supply.	Ensure that the gas supply is turned on.
	B. Loose sensor wire.	Ensure sensor wire connection is secure.
	C. Lose wires to valve.	Ensure black, green and orange wires connection is secure to valve.
	D. Loose wires to ignition module.	Ensure black sensor wire (S) and black igniter wire (I) is secure to ignition module.
	E. Air in the gas line.	Purge gas line of air.
	F. Low voltage.	Test voltage at AC terminals of module and/or batteries. It should be around 2.7 to 3.2 VAC.
3. The main burner come "ON" but then go "OFF".	A. Gas supply is turned "OFF".	Turned gas supply to "ON".
	B. Loose wire connection on valve or ignition module.	Check wire connection.
	C. Flame does not engulf flame sensor.	Check location of sensor.
	D. Obstructed vent system.	Check vent system for obstructions.
4. The log and glass soot.	A. Flame impingement on the log.	Check for proper log placement.
	B. Improper air shutter opening.	Check for proper air shutter openings.

REPLACEMENT PARTS LIST

No.	DESCRIPTION	ELDV35		ELDV40		ELDV45	
		Part No.	Qty.	Part No.	Qty.	Part No.	Qty.
	Gas Fireplace Assembly	-	-	-	-	-	-
1.	Enclose, Door Assembly	H4653	1	H4654	1	H4655	1
2.	Log Set	H4656	1	H4657	1	H4658	1
3.	Burner Assembly - Natural	H7203	1	H7204	1	H7204	1
	Burner Assembly - Propane	H7203	1	H7246	1	H7246	1
4.	Gasket - Venturi	43K85	1	43K85	1	43K85	1
5.	Venturi	H1428	1	H1428	1	H1428	1
6.	Bottom Panel	H4661	1	H4662	1	H4663	1
7.	Access Plate, Blower	H4664	1	H4664	1	H4664	1
8.	Latch	69L21	2	69L21	2	69L21	2
9.	Gasket, Access Plate, Blower	H4665	1	H4665	1	H4665	1
10.	Grate Assembly	H4666	1	H4667	1	H4667	1
11.	Burner Baffle	H4668	1	H4669	1	H4670	1
12.	Flex Gas Line	93L32	1	93L32	1	93L32	1
13.	Gas Line Tubing - Millivolt	H4671	1	H4671	1	H4671	1
	Gas Line Tubing - Electronic	H4672	1	H4672	1	H4672	1
14.	Orifice - Natural	99K76	1	24M10	1	18L40	1
	Orifice - Propane	39L10	1	21L01	1	74L88	1
15.	On/Off Control Switch	80L41	1	80L41	1	80L41	1
16.	Plate Relief Assembly	28L08	2	28L09	2	28L09	2
17.	Bracket Pressure Relief	H4680	2	H4680	2	H4680	2
18.	Volcanic Stone	80L42	1	80L42	1	80L42	2
19.	Vermiculite	H3696	1	H3696	1	H3696	1
20.	Gas Supply Access Plate	H4827	1	H4827	1	H4827	1
21.	Gasket, Access Plate, Gas	H4828	1	H4828	1	H4828	1
22.	Eyebrow	H5073	1	H5074	1	H5075	1
23.	Top Front Face	H5069	1	H5070	1	H5072	1
24.	Rear Log Support Bracket - Natural	H7247	1	H7248	1	H7248	1
	Rear Log Support Bracket - Propane	H7247	1	H7249	1	H7249	1

Gas Controls - SIT Millivolt

Item No.	Description	Natural Gas		Propane Gas	
		Part No.	Qty.	Part No.	Qty.
30	Gas Valve, SIT	43K07	1	88J53	1
31	Piezo Igniter	10K86	1	10K86	1
32	Pilot Assembly	69L17	1	69L18	1
33	Pilot Generator	60J79	1	60J79	1
34	Thermocouple	74L57	1	74L57	1
35	Pilot Tube	74L56	1	74L56	1
36	Electrode And Cable	74L58	1	74L58	1

Contact an Authorized Lennox Hearth Products dealer to obtain any of these parts. Never use substitute materials. Use of non-approved parts can result in poor performance and safety hazards.

WARNING

Failure to position the parts in accordance with these diagrams or failure to use only parts specifically approved with this appliance may result in property damage or personal injury.

Gas Controls - Dexen Electronic

Item No.	Description	Natural Gas	
		Part No.	Qty.
40	Gas Valve, Dexen	H4681	1
41	Pilot Assembly	H4673	1
42	Igniter Module	H4674	1
43	Battery Holder	H4675	1
44	Wire Harness	H4676	1
45	Adaptor	H4677	1

AVERTISSEMENT

Risque de dommages ou de blessures si les pièces ne sont pas installées conformément à ces schémas et ou si des pièces autres que celles spécifiquement approuvées avec cet appareil sont utilisées.

NOTE: DIAGRAMS & ILLUSTRATIONS ARE NOT TO SCALE.

Download from Www.Somanuals.com. All Manuals Search And Download.

REPLACEMENT PARTS

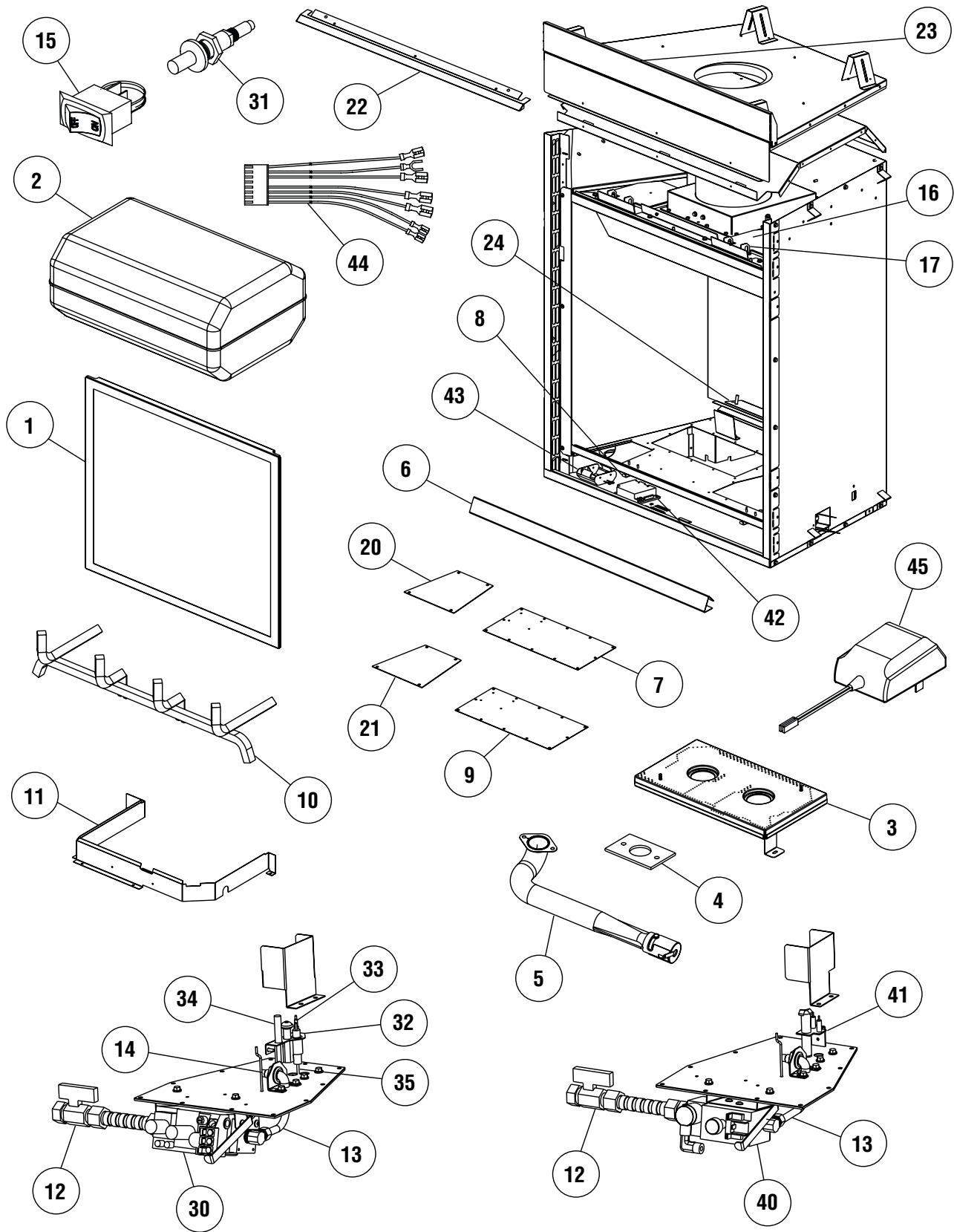

NOTE: DIAGRAMS & ILLUSTRATIONS NOT TO SCALE.

Notes

Lennox Hearth Products reserves the right to make changes at any time, without notice, in design, materials, specifications, prices and also to discontinue colors, styles and products. Consult your local distributor for fireplace code information.



Printed in U.S.A. © 2006 Lennox Hearth Products

P/N 875030M REV. E 02/2011

1508 Elm Hill Pike, Suite 108 • Nashville, TN 37210

Free Manuals Download Website

<http://myh66.com>

<http://usermanuals.us>

<http://www.somanuals.com>

<http://www.4manuals.cc>

<http://www.manual-lib.com>

<http://www.404manual.com>

<http://www.luxmanual.com>

<http://aubethermostatmanual.com>

Golf course search by state

<http://golfingnear.com>

Email search by domain

<http://emailbydomain.com>

Auto manuals search

<http://auto.somanuals.com>

TV manuals search

<http://tv.somanuals.com>