

DURABRAND

60 SECOND ESP PLUS™

**ELECTRONIC SHOCK PROTECTION
PROGRAMMABLE COMPACT DISC PLAYER**

WITH CAR ADAPTOR KIT AND REMOTE CONTROL

MODEL CD-895

OPERATING INSTRUCTIONS

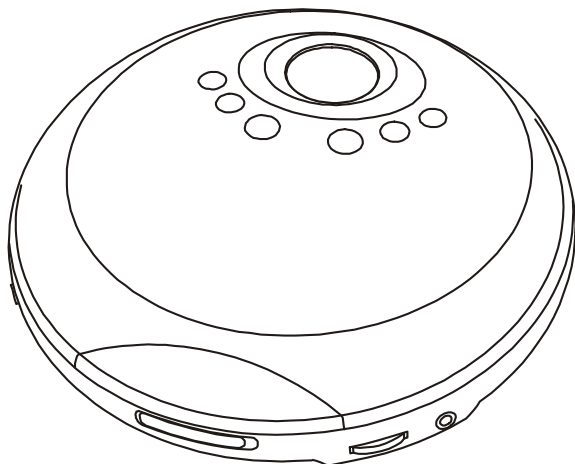

- **PLAYS MUSIC COMPACT DISCS**
- **INCLUDES WIRED REMOTE CONTROL**
- **BASS BOOST SYSTEM**
- **6 DIGIT LCD VISUAL DISPLAY**
- **TRACK REPEAT & DISC REPEAT**
- **60 SECOND ESP PLUS™ (ELECTRONIC SKIP PROTECTION) SYSTEM**
- **CAR POWER CORD AND CAR CASSETTE ADAPTOR INCLUDED**
- **DELUXE STEREO HEADPHONES INCLUDED**
- **USES 2 SIZE "AA" BATTERIES (NOT INCLUDED)**
- **LINE OUT JACK - CONNECTS TO YOUR STEREO SYSTEM**

PLEASE READ CAREFULLY BEFORE USE

IB-CD895(CDX25H-60K8)-WM-E-042004

Download from www.Somanuals.com. All Manuals Search And Download.

INTRODUCTION

Your new DURABRAND Model CD-895 portable compact disc player, uses the latest technology to give you crisp clean sound from all your compact discs.

Please read these operating instructions completely to take advantage of all the features of this set.

ACCESSORIES INCLUDED

STEREO HEADPHONES

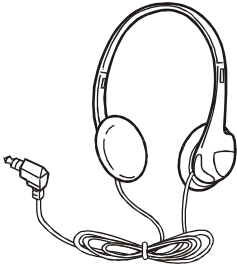

CAR CASSETTE ADAPTOR

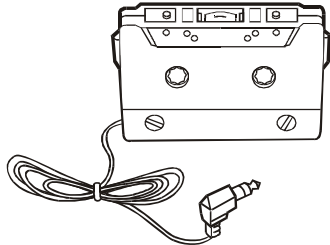

WIRED REMOTE CONTROL

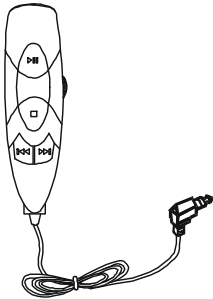

Plug into the PHONES jack

CAR CIGARETTE LIGHTER ADAPTOR

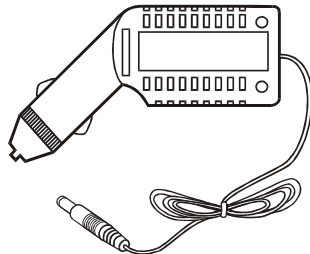

NOTE: Adaptor may look slightly different from above illustration.

LOCATION OF CONTROLS

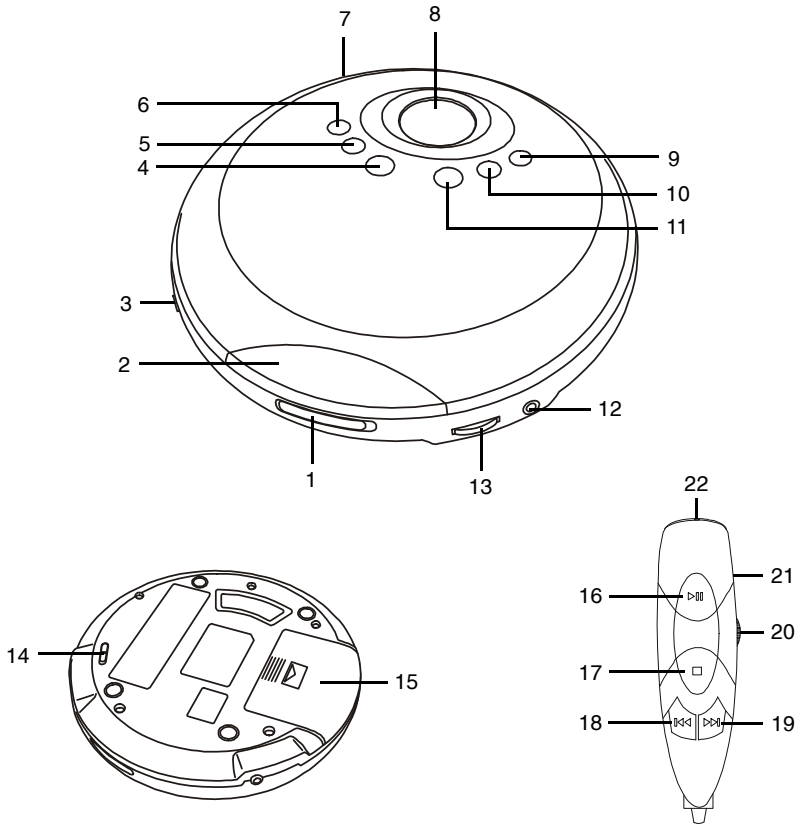

1. CD DOOR OPEN BUTTON (slide to open)
2. CD DOOR
3. PHONES/REMOTE JACK (headphones jack, also for REMOTE CONTROL connection)
4. STOP AND POWER OFF BUTTON
5. FORWARD SKIP/SEARCH BUTTON
6. BACKWARD SKIP/SEARCH BUTTON
7. AC ADAPTOR JACK (AC ADAPTOR not included)
8. LCD DISPLAY
9. REPEAT BUTTON
10. PROGRAM BUTTON (for programmed play)
11. PLAY/PAUSE & POWER ON BUTTON
12. LINE OUT JACK (for home stereo connection)
13. VOLUME CONTROL
14. BASS BOOST SWITCH
15. BATTERY DOOR

The following controls are for the Wired Remote Control

16. PLAY/PAUSE & POWER ON
17. STOP/OFF
18. SKIP/SEARCH BACKWARD
19. SKIP/SEARCH FORWARD
20. VOLUME CONTROL
21. BELT CLIP (at back)
22. HEADPHONES JACK

POWER SOURCES

Power this CD player by inserting 2 size "AA" fresh alkaline batteries, or using the provided Cigarette Lighter Adaptor.

1. USING WITH BATTERIES

Insert 2 size "AA" alkaline batteries according to the + and - markings on the bottom of the set.

NOTE: Player will not work, and batteries will be drained, if batteries are not inserted as shown on the bottom of the set.

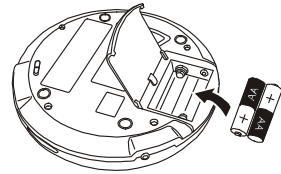

TIPS ON BATTERY USE

- Reversing polarities will damage the batteries and possibly your set. Be sure to follow polarity (+ and -) as indicated.
- Do not mix different types together (Alkaline, Carbon-Zinc, Nickel-Cadmium etc.), or old batteries with new ones.
- When not in use for an extended period of time, or while internal batteries will not be used, remove them to prevent possible acid leakage or corrosion resulting in damage to your player.
- When the batteries have become discharged, they must be disposed of in a safe manner that complies with all applicable laws.
- Installation of batteries should only be done by an adult (for safety).

ALKALINE BATTERY LIFE

Bear in mind that battery life expectancy is based upon volume and bass listening levels.

Maximum battery power consumption happens at maximum settings. Typical life for 2 size "AA" alkaline batteries is above 8 hours of continuous CD play.

2. AC ADAPTOR (OPTIONAL)

You can also power this CD player by connecting an optional AC adaptor. Before you buy an optional AC Adaptor, please note, the only AC ADAPTOR suitable for this player is DC 4.5V 600mA (or greater), with plus center polarity $\ominus \text{---} \oplus$. Others may damage your player. Please check voltage and current (mA) before buying an AC ADAPTOR.

WHEN SHOWS IN THE DISPLAY

While the CD is playing, if the alkaline batteries are weak or discharged, this symbol " " shows or flashes in the display, then the power automatically turns off. If this occurs, replace both alkaline batteries (also if the display does not show anything, the batteries are dead).

NOTE: You may use rechargeable batteries on this set. However, because rechargeable batteries generally have lower voltage (1.2 volts instead of 1.5 volts). Your playing time will be much less than normal fresh alkaline batteries.

3. USING CIGARETTE LIGHTER ADAPTOR

Use the cigarette lighter adaptor to supply power to your player and conserve battery life when using the CD player in a car (no batteries are needed).

- Plug the adaptor into the car's cigarette lighter. Insert firmly, and the cigarette lighter indicator will light up.
- Plug the other end into the DC 4.5V jack on the left rear of the set.

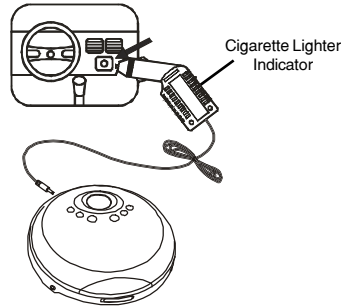

CAUTION:

- Use this set only with the supplied cigarette lighter adaptor. Use with other cigarette lighter adaptors could damage the set.
- When the inside of the cigarette lighter socket is dirty with ashes, the plug section may become hot due to poor contact. Be sure to clean your car cigarette lighter socket before use.
- After use, disconnect the cigarette lighter adaptor plugs from both the set and the cigarette lighter socket.
- The cigarette lighter adaptor may cause interference with reception to the car radio. If this happens, disconnect the cigarette lighter adaptor from the cigarette lighter socket.
- Do not leave the cigarette lighter adaptor plugged in without your car's motor running, your car's battery may drain in some models of cars that supply power to the cigarette lighter adaptor even with the car's keys removed.

If there is no power, your adaptor's internal fuse may have blown. To change fuse on cigarette lighter adaptor, unscrew the tip. Replace only with same 1A 120/250V fuse.

CASSETTE ADAPTOR

The car cassette adaptor allows you to use your CD player with your car stereo cassette system.

1. Insert the car cassette adaptor in the same direction as you would insert an audio cassette tape, with the side marked **THIS SIDE UP** facing upwards.
2. If the car cassette adaptor cord is on the wrong side of the tape, reposition the cord by following the instructions below.
3. Insert the car cassette adaptor stereo plug into the **LINE OUT** jack on the right side of the CD player.
4. Turn on the cassette player. Press the **PLAY** button on the cassette player.
5. Press the **PLAY** button on the CD player.
6. Adjust the **VOLUME** control on your cassette player.
7. When done, leave the cassette player on and first eject the adaptor, then turn off cassette player.

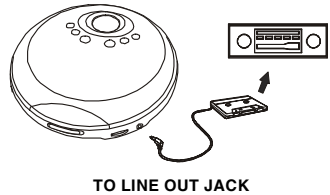

Reposition the cord

The cord should extend out from the cassette player when the cassette is inserted (direction depending on your tape player).

1. To reposition the cord, remove the top plate by removing 2 screws with a dime (see Fig. 1).
2. Reposition the cord so that it comes out from other positions (see Fig. 2).
3. Replace the cover and the screws.

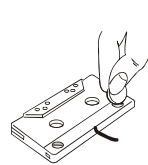

Fig. 1

Remove two large screws with a dime or screwdriver

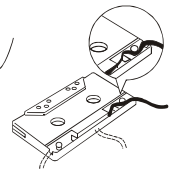

Fig. 2

Move cord to desired position (three cord positions)

NOTE: The car cassette adaptor has the play head on one side only. If the cassette adaptor keeps ejecting out, or the sound is weak, press the **REVERSE** button on your cassette player to change direction or reverse the adaptor.

CONNECTING TO HOME STEREO SYSTEMS

The **LINE OUT** jack is made to accept a stereo mini plug (3.5mm). Simply connect the cable's mini plug to the **LINE OUT** jack on your player, and the other appropriate end usually **RCA JACKS** to the **CD/AUX INPUTS** of your home stereo.

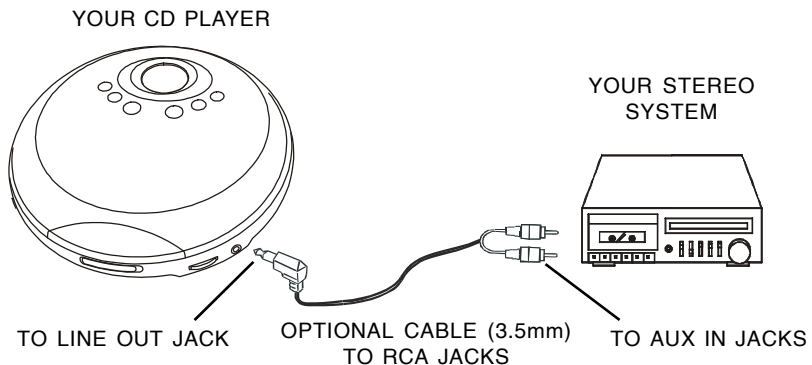

WIRED REMOTE CONTROL

You can control the CD PLAYER with the provided remote control (including the functions of PLAY/PAUSE AND POWER ON, STOP/OFF, SKIP/SEARCH BACKWARD and VOLUME CONTROL).

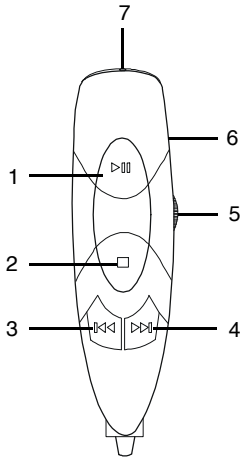

1. PLAY/PAUSE & POWER ON
2. STOP/OFF
3. SKIP/SEARCH BACKWARD
4. SKIP/SEARCH FORWARD
5. VOLUME CONTROL
6. BELT CLIP (at back)
7. HEADPHONES JACK

PLAYING CD'S WITH THE WIRED REMOTE CONTROL

The PHONES/REMOTE jack is made to play this player with the included WIRED REMOTE CONTROL. Simply insert the WIRED REMOTE CONTROL's plug to the PHONES/REMOTE jack on left side of this player, and plug the STEREO HEADPHONES' plug into the jack on the top of the WIRED REMOTE CONTROL.

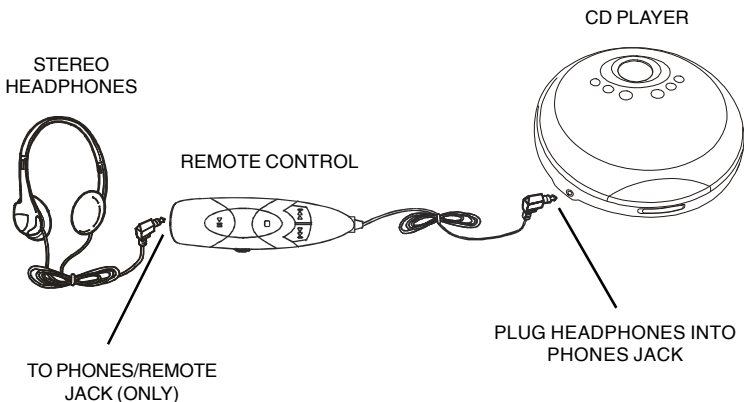

CD PLAYING

1 Load the Disc.

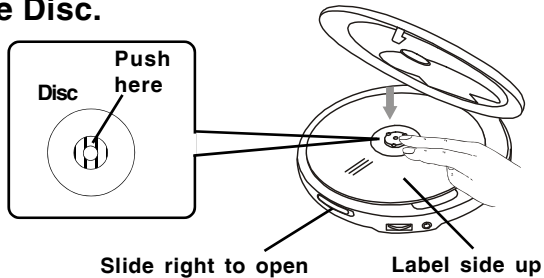

2 Connect the Headphones.

Stereo Headphones

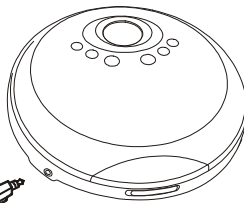

To PHONES jack

3 Press the PLAY/PAUSE button.

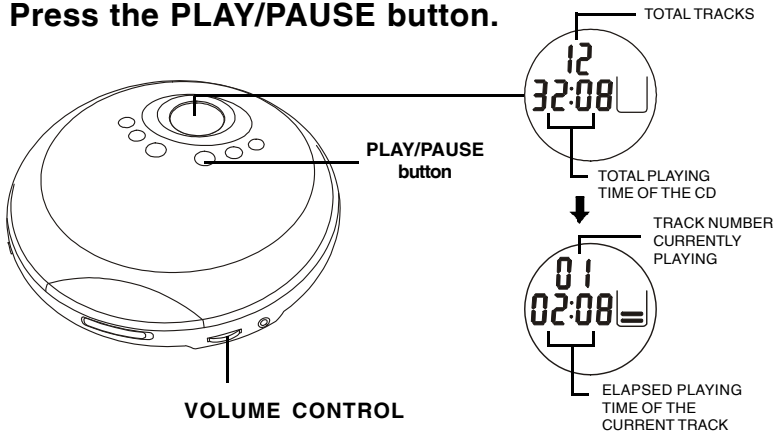

NOTE: The **ESP PLUS™** function will turn on automatically when the **PLAY/PAUSE** button is pressed.

4 Adjust the Volume.



OTHER OPERATIONS

Operation ● **Press** ● **Display window shows**

To pause play

PLAY/PAUSE button

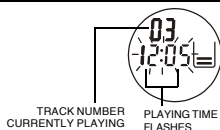

To release pause and resume play

PLAY/PAUSE button

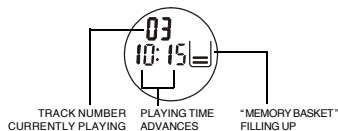

To stop

STOP button



To turn off the power

STOP button once and wait 30 seconds, or press STOP button twice.

To skip to the next track(s)

SKIP/SEARCH FORWARD button **▶▶** once (or repeatedly).

To skip to the previous track(s)

SKIP/SEARCH BACKWARD button **◀◀** once (or repeatedly).

To go ahead at high speed (search).

Keep SKIP/SEARCH FORWARD button **▶▶** depressed and release when the desired music section of the disc is found.

To go back at high speed (search).

Keep SKIP/SEARCH BACKWARD button **◀◀** depressed and release when the desired music section of the disc is found.

BASS BOOST switch

This switch enhances the low frequency (bass) sounds at low listening levels. Switch the BASS BOOST switch ON or OFF to suit your taste.

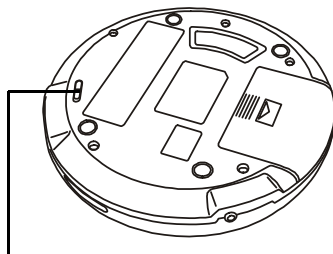

BASS BOOST switch

REPEAT, INTRO AND RANDOM PLAY

You may have repeat, intro or random play using the REPEAT button. Press the REPEAT button several times, and the display will show the followings in turn:

REPEAT ONE --> REPEAT ALL --> INTRO --> RND --> NORMAL PLAY

Single Track Repeat

Plays one song over and over till you press STOP.

During play, select the song you want to repeat with either of the SKIP/SEARCH buttons (◀◀ or ▶▶), then press the REPEAT button once, the symbol **REPEAT ONE** will appear in the display.

The song currently playing will repeat over and over, until you press STOP.



All Tracks Repeat

Repeats all songs in order, till you press STOP.

During play, press the REPEAT button twice, the symbol **REPEAT ALL** will show in the display.

All songs will keep playing in sequence 1, 2, 3, etc., and when finished, will start all over again until you press the STOP.



Intro Play

This plays the first 10 seconds of songs in sequential order.

1. During play, press the REPEAT button three times, the word **INTRO** will flash in the display.
2. Press the PLAY button, the word **INTRO** will stop flashing and the first 10 seconds of **each** song on the CD will play in sequential order.
3. When you find a song you like, press the PLAY button again, the symbol **INTRO** will disappear from the display, normal play will be resumed, that song (and the following songs) will play **NORMALLY**.



Random Play

This plays the songs on the disc in a random order.

1. During play, press REPEAT button four times the word **RND** will flash.
2. Press the PLAY button, this will play all of the songs in random order selected by the CD player. The word **RND** will stop flashing.
3. Press the SKIP/SEARCH button ▶▶ to skip to the next random song.



PROGRAMMED PLAY

The tracks (songs) on the disc can be programmed (arranged in advance) to play in any order you prefer (up to 20 tracks can be programmed).

Programming Example:									
Program Number	1	2	3	4	5	6	7	8	etc.
Track Number (song number)	3	5	8	1	2	4	1	1	etc.

During programming, the word **PROG** flashes in the display. To program songs to play in your preferred order, follow steps below:

1. Press the PROGRAM button.



PROGRAM

The word **PROG** and "00" will flash in the display.



Program number

2. Press the SKIP/SEARCH button (◀◀ or ▶▶) to select track number 3 (example). **PROG** and track number "03" will flash in the display.



SKIP
SEARCH



Track number

3. Press the PROGRAM button to confirm. Track 3 is now programmed.

Program number 2 will now show in the display, ready for your next selection of track.



4. Repeat steps 2 and 3 to program other tracks till you finish (up to 20 selections).

5. After programming is finished, press the PLAY button to begin programmed play. The word **PROG** changes to be steadily on in the display, and music begins to play in the order you programmed.



PLAY/PAUSE

NOTE:

- The player will stop automatically after all programmed tracks have been played.
- To quit programmed play, press the STOP button once. Then you may press the PLAY button to re-start normal play.

Your programmed memory will be lost:

- When the alkaline batteries are exhausted or removed, or the optional AC ADAPTOR is disconnected.
- When the power is shut off.

60 SECOND ESP PLUS™ ANTI-SKIP SYSTEM

This set is designed with the latest 60 second **ESP PLUS™** (Electronic Shock Protection) - which allows virtually unlimited gentle skip protection above the normal 60 second shock protection.

The 60 second **ESP PLUS™** function prevents the sound from skipping by using a buffer memory that stores music data. The new 60 second **ESP PLUS™** system can store more music than normal 60 second anti-skip systems.

This new design allows gentle swaying of the set (as in walking) without music skipping. This function (CD **ESP PLUS™**) may not work during heavy jogging.

The 60 second **ESP PLUS™** function will turn on automatically when the PLAY/PAUSE button is pressed.

When the PLAY/PAUSE button is pressed, the “ □ ” (memory basket) indicator will appear in the display, the digital data (music) is stored in the “read-ahead” memory buffer before it is decoded and played.

The “ □ ” mark changes to the “ ▒ ” mark, indicating that the memory buffer (basket) is full.

- When the set is subject to a shock or a bump during play, the data stored in memory continues to be decoded and played. This gives the pickup time to stabilize and continue reading new music. As the data is used from memory, the indicator changes from “ ▒ ” to “ ▒ ”. Once the pickup returns to its original position, new data is stored in memory and the display changes back to the “ ▒ ” mark.

- If the set is subject to repeated shocks and all the data stored in memory is used up, the “ □ ” mark is displayed and the sound will skip or stop for a brief period until the memory basket has time to fill up again.

NOTE:

- The music may stop if the player receives continuous shocking.
- You may hear noise or skipping if the CD is dirty or scratched.
- If you press SKIP/SEARCH buttons, the memory basket will empty itself temporarily.



EMPTY MEMORY



FULL MEMORY



SOME MEMORY USED



ALL MEMORY USED UP

MAINTENANCE

Cleaning the lens

A dirty lens will cause sound skipping. If the lens is very dirty, the player may not work. We suggest using a special cleaning disk (not included) available in most music and Hi-Fi stores. However, if you do not have one, you may use a cotton swab very slightly dampened with alcohol to clean the lens.

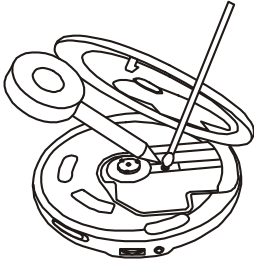

Cleaning the cabinet

Wipe with a soft cloth. If the cabinet is very dirty, dampen (not dripping wet) the cloth with a weak solution of soapy water, and then wipe clean.

Cleaning the Discs

- Fingerprints should be carefully wiped from the surface of disc with a soft cloth. Unlike conventional records, compact discs have no grooves to collect dust and microscopic dirt, so gently wiping them with a soft cloth should remove most particles. Wipe in a straight motion from the center to the edge.

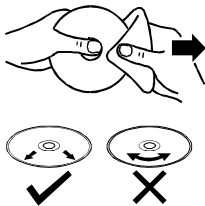

- Never use thinner, benzene, record cleaner or antistatic spray on a compact disc. Such chemicals can damage its plastic surface.

Handling Compact Discs

- Dirty, scratched or warped discs may cause skipping or noise.
- Handle the disc only by the edges. To keep clean, do not touch its surface.



- Discs should be stored in their cases after use to avoid scratches.
- Do not expose discs to direct sunlight, high humidity, high temperatures, or dust, etc. Prolonged exposure to extreme temperatures can warp the disc (such as leaving the discs in your car during summertime).
- Do not stick or write anything on either side of disc. Sharp writing instruments, or the inks used in some felt-tip pens, may damage its surface.

To remove the Disc

Open the CD DOOR by sliding the **DOOR OPEN** button, hold the disc by the edge while slightly pressing on the center spindle as illustrated, then lift it from the edge to release and remove.

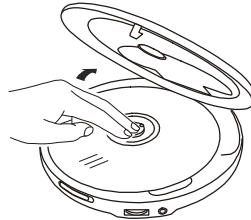

NOTE:

Always press the STOP button and wait for the disc to stop rotating before sliding the DOOR OPEN button to remove the disc.

SAFETY PRECAUTIONS

Do not take the set apart. The laser beam used in the set may harm your eyes. Refer servicing to qualified service personnel only.

Do not insert pins or coins, clips, or any objects inside the set.

This set is equipped with a safety device which automatically turns the laser beam off when the CD DOOR is opened.

Do not drop the set or subject it to strong shocks. Doing so could result in damage.

Do not place the set in locations where the temperature is high, or in humid or dusty locations, or locations with long heavy vibrations, or tilted surfaces.

The set's cabinet may warp or the set may be damaged if it is placed in direct sunlight, near heaters (where the temperature is 140°F/60°C or higher) or in cars with the windows closed. In the summer, the temperature may get as high as 212°F/100°C or more.

Use the set within a temperature range of 41°F/5°C to 95°F/35°C.

Use ONLY the optional DC 4.5V AC ADAPTOR with polarity $\ominus \leftarrow \oplus$, others may damage your set. Disconnect the ADAPTOR from the wall outlet when the set is not to be used for an extended period of time (3 days or more).

When cleaning your set, use a soft dry cloth. Do not use solvents or commercially available cleaners, as they may damage or discolor the finish.

Do not wear headphones while operating a motor vehicle. This could create a traffic hazard and is illegal in many areas. Do not use this set when bicycling or running.

The headphones supplied with your set provide superb stereo listening while allowing you to hear some outside sounds when listening at normally low volume levels. Listening at extremely high volume levels minimizes the intrusion of outside noise/sounds. In the interest of safety, it is strongly advised against the use while engaging in activities where the exclusion of external sounds (whistles, horns, sirens, traffic, etc.) could be hazardous. Also loud volume can hurt your ears. If you notice that the sound has become weak or distorted or if tracks do not change, this is an indication that your batteries are weak. Replace both batteries at the same time (see Using with Batteries). Your CD-895 is identified by a serial number stuck inside the battery compartment. Record this number in the space provided below.

Model CD-895

Serial No.

Date Purchased:

This manual contains detailed information on its safety and use. Please read it carefully so that you may take full advantage of its many features, and ensure a safe reliable operation. Keep this manual for future reference.

CONDENSATION

If cold water is poured into a glass, water droplets form on the outside of the glass. This is called condensation. Condensation may occur on internal operating parts of the lens.

Condensation occurs:

When the set is brought from the cold outdoors into a warm room, or if it is in a cold room to a room which is heated, or in the summer, if the set is moved from an air-conditioned room or car to a hot or humid location.

Should condensation occur, the set may not operate properly. Open the CD DOOR and wait for about 20 minutes (to allow the internal parts to adjust to the surrounding temperature) before using the set.

IMPORTANT REQUIREMENT BY THE FCC

Since the CD circuitry may cause interference to other radios nearby, switch this set off when not in use or move it away from the affected radios.

This device complies with Part 15 of the FCC Rules. Operation is subject to the following two conditions: (1) This device may not cause harmful interference, and (2) This device must accept any interference received, including interference that may cause undesirable operation.

NOTE: This equipment has been tested and found to comply with the limits for a Class B digital device, pursuant to Part 15 of the FCC Rules. These limits are designed to provide reasonable protection against harmful interference in a residential installation. This equipment generates, uses and can radiate radio frequency energy and, if not installed and used in accordance with the instructions, may cause harmful interference to radio communications. However, there is no guarantee that interference will not occur in a particular installation. If this equipment does cause harmful interference to radio or television reception, which can be determined by turning the equipment off and on, the user is encouraged to try to correct the interference by one or more of the following measures:

- Reorient or relocate the receiving antenna.
- Increase the separation between the equipment and receiver.
- Connect the equipment into an outlet on a circuit different from that to which the receiver is connected.
- Consult the dealer or an experienced radio/TV technician for help.

SAFETY CERTIFICATION

This Compact Disc Player is made and tested to meet safety standards of the FCC requirements and comply with safety performance of the U.S. Department of Health and Human Services, and also with FDA Radiation Performance Standards 21 CFR Subchapter J.

WARNING

- To prevent fire or shock hazard, do not expose this appliance to rain or moisture.

LASER SAFETY

THIS SET EMPLOYS AN OPTICAL LASER BEAM SYSTEM IN THE CD MECHANISM, DESIGNED WITH BUILT-IN SAFEGUARDS. DO NOT ATTEMPT TO DISASSEMBLE. EXPOSURE TO THIS INVISIBLE LASER LIGHT BEAM MAY BE HARMFUL TO HUMAN EYES. THIS IS A CLASS-1 LASER PRODUCT. USE OF ADJUSTMENTS OTHER THAN THOSE SPECIFIED HEREIN, MAY RESULT IN HAZARDOUS LASER LIGHT BEAM EXPOSURE. THIS COMPACT DISC PLAYER SHOULD NOT BE ADJUSTED OR REPAIRED BY ANYONE EXCEPT QUALIFIED SERVICE PERSONNEL. THE LASER MECHANISM IN THE SET CORRESPONDS TO THE STYLUS (NEEDLE) OF A RECORD PLAYER. ALTHOUGH THIS PRODUCT USES A LASER PICK-UP LENS, IT IS COMPLETELY SAFE WHEN OPERATED ACCORDING TO DIRECTIONS.

TROUBLE SHOOTING GUIDE

Symptoms	Causes	Solutions
Tracks do not change or set does not play normally.	Batteries are weak (they may test OK on tester but they are weak for CD operation).	Replace both batteries with fresh alkaline batteries. Battery life with fresh batteries is above 8 hours for continuous CD play (rechargeable batteries have 1/2 of that life).
CD Player will not turn on.	Dead or weak batteries.	Replace both batteries with fresh ones.
	The optional AC ADAPTOR not connected properly.	Check AC ADAPTOR connection at AC outlet and the left side of the set.
Disc will not play.	Disc inserted incorrectly.	Re-insert disc with label side facing up.
	Defective compact disc.	Try another compact disc.
	CD DOOR not closed.	Close the door securely.
	Moisture has formed inside the CD deck.	Take out the CD and leave the CD Door open for about 20 minutes to dry the moisture condensation.
No sound from headphones.	Headphone plug not inserted properly.	Re-insert headphone plug into PHONES jack (not LINE OUT) on the set or on the top of the REMOTE CONTROL.
	VOLUME control set to minimum.	Increase the volume of the set or on the REMOTE CONTROL.
	Weak batteries.	Replace with fresh batteries or use an optional AC ADAPTOR.
	Defective compact disc.	Try another compact disc.
VOLUME control has no function.	Headphones plugged into LINE OUT jack.	Plug headphones into PHONES jack. (NOT THE LINE OUT JACK)
Sound is skipping or sound stops.	The compact disc or lens is dirty or CD is scratched.	Clean or replace the compact disc or clean the lens.
	Strong vibrations.	Place the player on a stable level.
Sound is distorted.	Music is too loud.	Lower the VOLUME control.
	BASS BOOST is ON.	Slide BASS BOOST switch to OFF.
	Weak batteries.	Replace both batteries or use an optional AC ADAPTOR.
Buttons do not work.	Electronic or static error caused circuitry to lock.	Remove batteries and ADAPTOR. Wait 15 seconds and re-insert. Make sure batteries are fresh or the optional ADAPTOR has power.
Car Cassette Adaptor ejects from radio.	Your car may have special cassette player.	Press the REVERSE button on your cassette player or reverse the adaptor.
Cigarette Lighter Adaptor has no power or Cigarette Lighter Indicator does not light up.	Poor contact.	Insert Adaptor firmly and fully (make sure socket is clean).
	Fuse is blown.	Unscrew Adaptor tip and replace fuse inside the Adaptor. Also check the Car's fuse.

TECHNICAL SPECIFICATIONS

CD Player Section

Frequency response	50Hz-15kHz +1/-2dB
Sampling frequency	44.1kHz
D/A converter	1-bit
Error correction method	CIRC
Pickup	Optical 3-beam semiconductor laser (780 nm wavelength)
Laser diode material	GaAlAs
Laser output	less than 44.6 μ W

NOTE: This CD player will only play **NORMAL** music CDs (or CD-R CDs).
This set will not play **CD-RW** encoded discs.

General

Maximum output (stereo headphones)	20mW + 20mW
Power Supply	
AC adaptor	120V/60Hz DC 4.5V Output (not included)
DC	3V: Using 2 size "AA" batteries (not included)
Set Dimensions (approximate)	
Width	5 1/2 "
Depth	5 1/2 "
Height	1 "
Weight (approximate)	9.5oz. (270g) (set only)

Because the products are subject to continuous improvement, LENOXX reserves the right to modify product designs and specifications without notice and without incurring any obligation.

LIMITED WARRANTY

We warrant this product to be free from defects in material and workmanship under normal use for a period of 90 days after purchase and we will repair it free of charge or replace it at no charge, should it become defective under this warranty, providing you submit proof of purchase (sales slip) with the set.

During the initial 90 day period after original purchase, we will service or exchange, at no charge, the set that is returned to LENOXX ELECTRONICS CORP. After the initial 90 day period expires, and for a period of 12 months from original purchase, we will repair the unit covering any part(s) that need to be replaced at no charge, but will charge for the cost of labor, return postage paid by Lenoxx.

This warranty does not apply to any products which have been subject to misuse, neglect or accident. This warranty does not cover broken headphones or cabinet. **UNDER NO CIRCUMSTANCES WILL LENOXX ELECTRONICS CORP. BE LIABLE FOR ANY INCIDENTAL OR CONSEQUENTIAL DAMAGES.** Some states do not allow the exclusion or limitation of incidental or consequential damages, so the above limitations or exclusions may not apply to you.

This warranty gives you specific legal rights, and you may also have other rights which vary from state to state. The following charges apply to repairs beyond the warranty period: \$15.00. Be sure to pack carefully and return postage paid insured together with your money order (personal checks will not be accepted) and sales receipt to: LENOXX ELECTRONICS CORP., 2 GERMAK DRIVE, CARTERET N.J. 07008

For customer service Dial:1-800-315-5885

(MONDAY - THURSDAY 9:00 AM - 5:00 PM, FRIDAY 9:00 AM - 1:00 PM EST)

<http://www.lenoxx.com>

© 2004 LENOXX ELECTRONICS CORP.
2 GERMAK DRIVE
CARTERET, N.J. 07008
MADE & PRINTED IN CHINA

Free Manuals Download Website

<http://myh66.com>

<http://usermanuals.us>

<http://www.somanuals.com>

<http://www.4manuals.cc>

<http://www.manual-lib.com>

<http://www.404manual.com>

<http://www.luxmanual.com>

<http://aubethermostatmanual.com>

Golf course search by state

<http://golfingnear.com>

Email search by domain

<http://emailbydomain.com>

Auto manuals search

<http://auto.somanuals.com>

TV manuals search

<http://tv.somanuals.com>