

*Lenox Sound*<sup>®</sup>

**CD AUDIO SYSTEM**  
**COMPACT DISC PLAYER**  
**AM/FM STEREO CASSETTE RECORDER**  
**MODEL SL-326**  
**OPERATING INSTRUCTIONS**

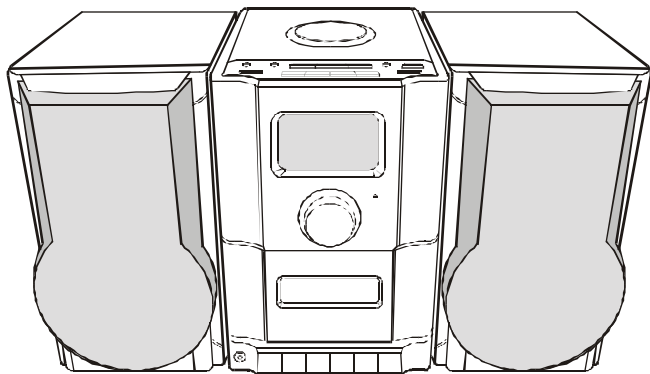

- **DIGITAL RADIO WITH PRESETS**
- **PLAYS ALL MUSIC COMPACT DISCS**
- **FULLY PROGRAMMABLE CD PLAYER WITH REPEAT PLAY**
- **RECEIVES AM/FM STEREO BROADCASTS**
- **RECORDS CASSETTES FROM CD OR RADIO**
- **AC POWER INDICATOR**
- **LARGE BACKLIT LCD DISPLAY FOR CD & RADIO**
- **PRESET GRAPHIC EQUALIZER SYSTEM**
- **BASS REFLEX SPEAKER SYSTEM**

# SAFETY INSTRUCTIONS



The lightning flash and arrow head within the triangle is a warning sign alerting you of "dangerous voltage" inside the product.

## CAUTION

**RISK OF ELECTRIC SHOCK  
DO NOT OPEN**

CAUTION: TO REDUCE THE RISK OF ELECTRIC SHOCK, DO NOT REMOVE COVER (OR BACK). NO USER SERVICEABLE PARTS INSIDE. REFER SERVICING TO QUALIFIED SERVICE PERSONNEL.



The exclamation point within the triangle is a warning sign alerting you of important instructions accompanying the product.

**WARNING: TO REDUCE THE RISK OF FIRE OR ELECTRIC SHOCK, DO NOT EXPOSE THIS APPLIANCE TO RAIN OR MOISTURE.**

THESE IMPORTANT SAFETY INSTRUCTIONS ARE INCLUDED, AS APPLICABLE TO THE APPLIANCE, CONVEYING TO THE USER THE INFORMATION ITEMIZED BELOW:

1. **Read Instructions** - All the safety and operating instructions should be read before the appliance is operated.
2. **Retain Instructions** - The safety and operating instructions should be retained for future reference.
3. **Heed Warnings** - All warnings on the appliance and in the operating instructions should be adhered to.
4. **Follow Instructions** - All operating and use instructions should be followed.
5. **Water and Moisture** - The appliance should not be used near water - for example near a bathtub, washbowl, kitchen sink, laundry tub, in a wet basement, or near a swimming pool, and the like.
6. **Wall or Ceiling Mounting** - The appliance should not be mounted to a wall or ceiling.
7. **Ventilation** - The appliance should be situated so that its location or position does not interfere with its proper ventilation. For example, the appliance should not be situated on a bed, sofa, rug, or similar surface that may block the ventilation openings; or, placed in a built-in installation, such as a bookcase or cabinet that impede the flow of air through the ventilation openings.
8. **Heat** - The appliance should be situated away from heat sources such as radiators, heat registers, stoves, or other appliances (including amplifiers) that produce heat.
9. **Power Sources** - The appliance should be connected to a power supply only of the type described in the operating instructions or as marked on the appliance.
10. **Grounding or Polarization** - Precautions should be taken so that the grounding or polarization means of an appliance is not defeated.
11. **Power Cord Protection** - Power supply cords should be routed so that they are not likely to be walked on or pinched by items placed upon or against them, paying particular attention to cords at plugs, convenient receptacles, and the point where they exit from the appliance.
12. **Cleaning** - The appliance should be cleaned only as recommended by the manufacturer.
13. **Nonuse periods** - The power cord of the appliance should be unplugged from the outlet when left unused for a long period of time.

# SAFETY INSTRUCTIONS

14. **Object and Liquid Entry** - Care should be taken so that objects do not fall and liquids are not spilled into the enclosure through openings.
15. **Damage Requiring Service** - The appliance should be serviced by qualified service personnel when:
  - A. The power supply cord or the plug has been damaged; or
  - B. Objects have fallen, or liquid has been spilled into the appliance; or
  - C. The appliance has been exposed to rain; or
  - D. The appliance does not appear to operate normally or exhibits a marked change in performance; or
  - E. The appliance has been dropped, or the enclosure damaged.
16. **Servicing** - The user should not attempt to service the appliance beyond that described in the operating instructions. All other servicing should be referred to qualified service personnel.
17. **Power lines** - An outdoor antenna should be located away from power lines.
18. **Outdoor Antenna Grounding** - If an outside antenna is connected to the receiver, be sure the antenna system is grounded so as to provide some protection against voltage surges and built up static charges. Section 810 of the National Electrical Code, ANSI/NFPA 70 provides information with respect to proper grounding of the mast and supporting structure, grounding of the lead-in wire to an antenna discharge unit, size of grounding conductors, location of antenna-discharge unit, connection to grounding electrodes, and requirements for the grounding electrode. See Figure.

EXAMPLE OF ANTENNA GROUNDING AS PER  
NEC - NATIONAL ELECTRICAL CODE

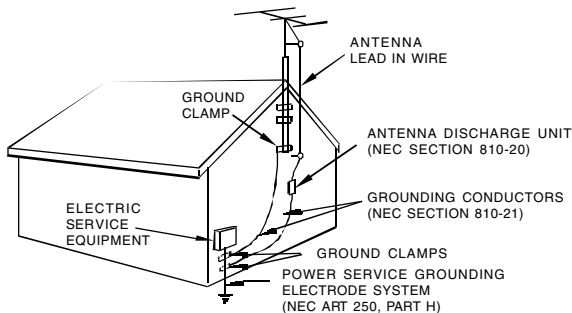

It is the intent of Lennox that this product be used in full compliance with the copyright laws of the United States and that prior permission be obtained from copyright owners whenever recording songs from the RADIO or CD's.

Do not apply oil or petroleum products or solvents to any part of this set.

## CAUTION

Use of controls or adjustments or performance of procedures other than those specified herein may result in hazardous radiation exposure.

This compact disc player is classified as CLASS 1 LASER PRODUCT as stated on the back of the set.

## CONNECTING THE SPEAKERS

Carefully unwind and stretch out the speaker wire on the back of each speaker box and plug the right plug into Speaker Jack marked RIGHT, and the left plug into Speaker Jack marked LEFT.

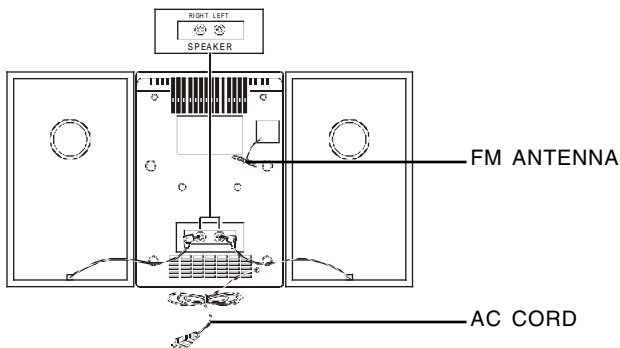

Unwind the FM ANTENNA (thin wire) at the back of the set and straighten it out for FM reception.

## POWERING UP

Plug the AC POWER CORD into a 120V, 60Hz wall outlet. The AC POWER STANDBY INDICATOR will be on. This indicator shows you that the set & outlet are OK.

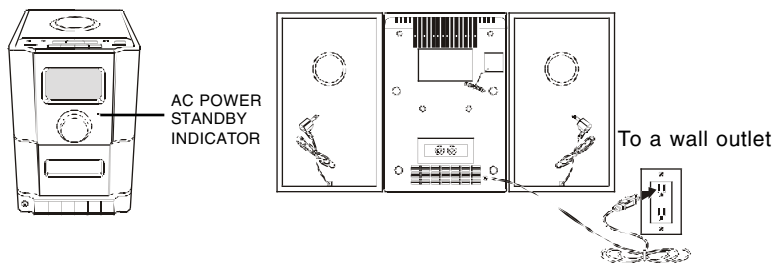







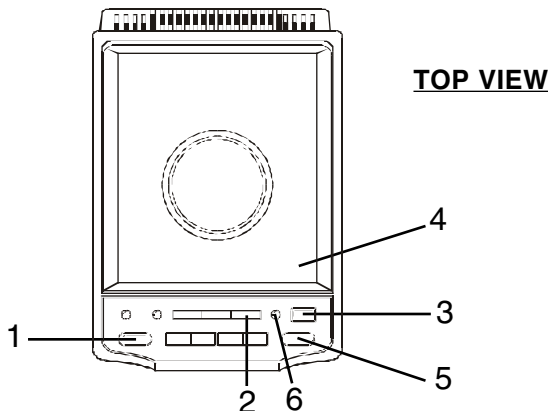



**NOTE:** One blade of plug and outlet is wider.

**TIP**  
If the plug of the AC power cord does not match your outlet, do not force it. Reverse it and try again. The plug is polarized and only fits one way into the wall outlet.

# PLAYING A CD

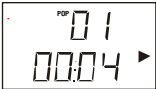

Connect the AC power cord (see page 3).

- |   |  |  |   |
|---|--|--|---|
| 1 |  <p>↓ POWER</p>                       | <p>Press the POWER switch, the AC POWER STANDBY INDICATOR will go off and the display will light up.</p>                                       |   |
| 2 |  <p>FUNCTION</p> <p>RADIO TAPE CD</p> | <p>Press the CD FUNCTION switch, the display will show six zeros "0".</p>  |    |
| 3 |  <p>PUSH ▲ OPEN</p>                   | <p>Press the PUSH ▲ OPEN button to open the CD DOOR and place the disc in the CD compartment. The label side of the CD should face upward.</p> |   |
| 4 |                                     | <p>Close the CD DOOR by pushing it down at the right corner. The display will show the total tracks on that CD (after a few seconds).</p>      |  <p>TOTAL PLAYING TIME ON THE CD</p> <p>TOTAL TRACKS</p> |
| 5 |  <p>PLAY/PAUSE</p>                  | <p>Press the CD PLAY button. The player will play all the tracks (songs) once.</p>   |  <p>TRACK</p> <p>PLAYING TIME</p>                        |
| 6 |  <p>EQUALIZER</p>                   | <p>Press the EQUALIZER button to choose different music effects (CLASSIC, ROCK, POP or normal).</p>  |  <p>POP</p>  |

## USE THESE BUTTONS FOR ADDITIONAL OPERATIONS



### TIP

When CD play is paused, the elapsed playing time will flash and no music will play.

To resume play, press the PAUSE button again, the elapsed playing time will stop flashing and music will play.

### TIP

If you bump the set or table it is sitting on, during CD play, the music will stop or skip for a few seconds. This is normal for this type of player.

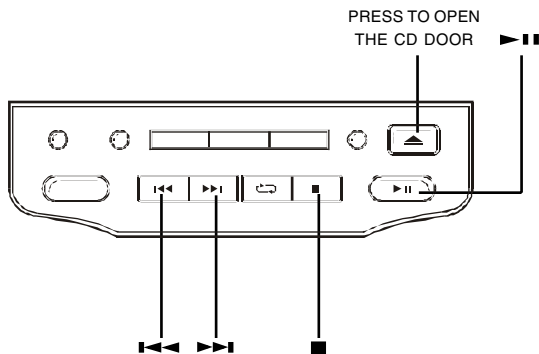

To	Press or Adjust
Adjust the volume	VOLUME control
Stop playback	■
Pause playback	▶▶ The elapsed playing time will flash during pause. Press again to resume play after pause.
Go to the next track	▶▶ FORWARDS
Go back to the previous track	◀◀ BACKWARDS
Locate a point in a song	◀◀ or ▶▶ Press and hold down while playing until you find the point.
Remove the CD	Press the CD DOOR OPEN button (press STOP first)
Turn off the player	Press the POWER switch, the AC POWER STANDBY INDICATOR will go on.

# REPEAT PLAY

## PLAYING CD SONGS (TRACKS) OVER AND OVER

You can play CD tracks over and over in normal or programmed play modes (see page 7).

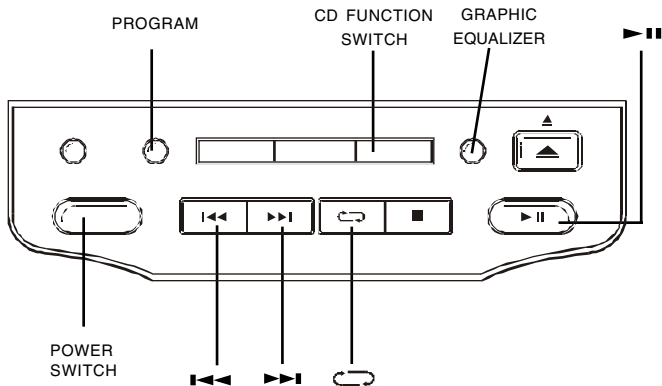

1. Press the POWER switch, the AC POWER STANDBY INDICATOR will go off.
2. Press the CD FUNCTION switch.
3. Select the track by pressing **⏮** or **⏭** , and then press **▶||** .
4. Press the CD REPEAT button.

To repeat	Press	Display shows
a single track (song)	Press the REPEAT button twice	<b>"REPEAT"</b> Flashing
all the tracks (all songs)	Press the REPEAT button once	<b>"REPEAT"</b> steady on
programmed tracks	During programmed play, press the REPEAT button once	<b>"REPEAT"</b> steady on ( <b>"MEMORY"</b> also on)

### To cancel Repeat Play

Press the REPEAT button until the **"REPEAT"** goes off in the display.

# SELECTING YOUR OWN MUSIC PLAYING ORDER (Programmed Play)

You can make a program of up to 20 tracks in the order you want them to be played.

**NOTE:** Programming is only done during stop mode.

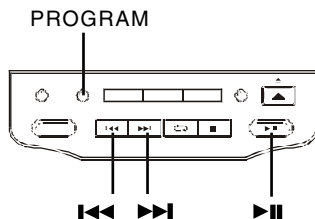



- 1**

**PROGRAM**  
  
**MEMORY**

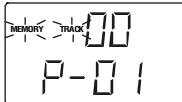
During **STOP** mode, press the **PROGRAM (MEMORY)** button. The display will show “P-01”, “MEMORY” and “TRACK” will flash in the display.

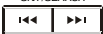
- 2**

**SKIP/SEARCH**  
  
**DOWN - TUNING - UP**

Press the **SKIP/SEARCH** buttons either  or  until the desired track shows in the display.

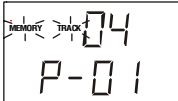

- 3**

**PROGRAM**  
  
**MEMORY**

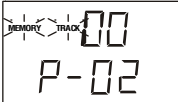
Press the **PROGRAM** button. The display will show “P-02”.

- 4**

Repeat steps 2&3 until all the desired tracks are programmed.
- 5**

  
**PLAY/PAUSE**

Press the **PLAY** button to start program play. “MEMORY” and “TRACK” will be steady in the display, the track number being played will show in the display.



## To change the current program

Just create a new program following the programming procedure.

## To cancel Program Play

Press the **STOP** button.



# LISTENING TO THE RADIO

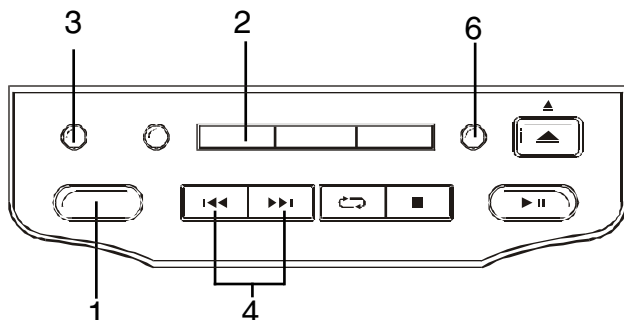

Connect the AC power cord (see page 3).

1



Press the POWER switch, the AC POWER STANDBY INDICATOR will be off.

2



Press the RADIO FUNCTION switch.

3



Press the BAND switch to choose the proper band (AM or FM ) that you want.

4



Tune into the station you prefer using the TUNING UP or DOWN button. Each time the button is pressed, the frequency changes. Keep the button pressed, the station will change rapidly (automatic tuning), release the button and it will stop at the next strong station. **(NOTE: For FM stations, unwind and straighten out the FM antenna at the back of the set.)**

5

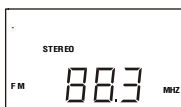

“STEREO” will light up when receiving FM Stereo broadcasts.

6



Press the GRAPHIC EQUALIZER button to choose different music effects (CLASSIC, ROCK, POP or normal).

# PRESETTING RADIO STATIONS

Allows you to store your favorite stations for quick one button tuning.

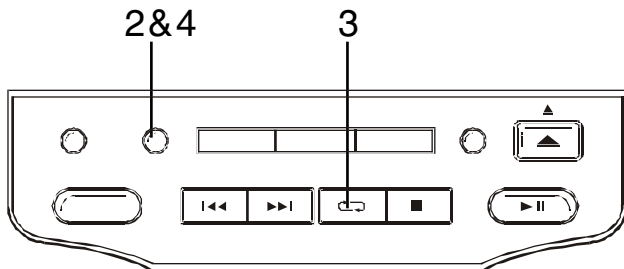

Connect the AC power cord (see page 3).

- 1 Follow Steps 1 to 4 (**LISTENING TO THE RADIO** on the previous page) to select a station.

- 2  Press the PROGRAM (MEMORY) button, “CH” will show and “MEMORY” will flash in the display for about 5 seconds.

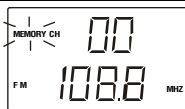

- 3  While the “MEMORY” is flashing, press the PRESET (REPEAT) button to choose a memory location (01-20).

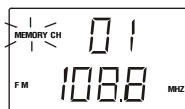

- 4  Press the PROGRAM (MEMORY) button again to confirm, the station now broadcasting is stored into that preset memory location. “MEMORY” disappears from the display.





**NOTE:** Steps 2-4 should be done quickly.

- 5 Repeat the above steps to store other 19 stations into memory.

**TIP: UP TO 20 AM AND 20 FM STATIONS CAN BE STORED INTO THE PRESET MEMORY LOCATIONS.**

# LISTENING TO THE PRESET STATIONS

(after you programmed them)

-  Press the POWER switch, the dial will light.
-  Press the AM/FM BAND switch to select the desired band.
-  Press the PRESET (REPEAT) button several times to choose a memory location (01-20). You will receive the station you stored into that preset memory location.

Connect the AC power cord (see page 3).

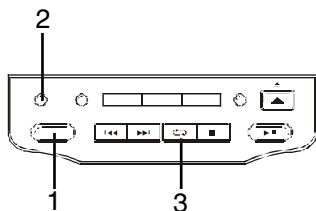

## USE THESE BUTTONS FOR ADDITIONAL OPERATIONS

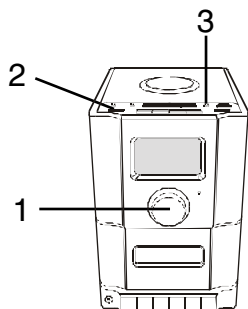

To	Press or Adjust
1. Adjust the volume	VOLUME control
2. Turn off the Radio	POWER switch
3. Choose different sound effect	EQUALIZER button

## TO IMPROVE BROADCAST RECEPTION

Unwind and stretch out the FM antenna for FM or FM Stereo. Move the set itself for AM (if needed).

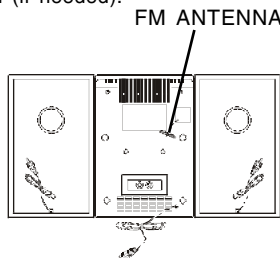

UNWIND THE WIRE FOR  
BETTER FM RECEPTION

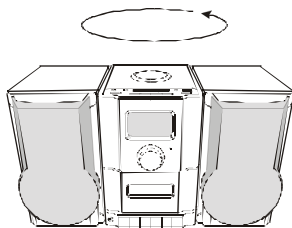

FOR BETTER AM RECEPTION

# PLAYING A TAPE

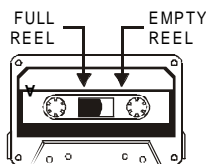
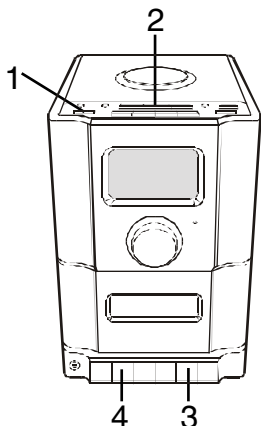

INSERT THIS WAY

Connect the AC power cord (see page 3).



Press the POWER switch, the dial will light up.



Press the TAPE FUNCTION switch.



Press the STOP/EJECT button to open the tape compartment and insert a recorded tape as shown. Close the door.

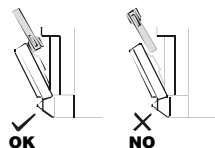

Press the PLAY button. The player turns on and starts playing.

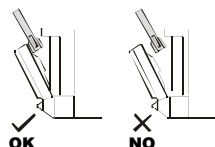

When the set finishes playing this side of the tape, the set will stop. To hear the other side of the tape, flip the tape over, then insert and press PLAY.

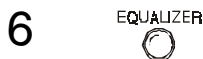
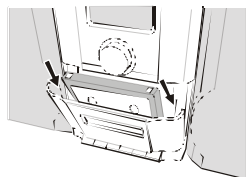

Press the GRAPHIC EQUALIZER button to choose different music effect (CLASSIC, ROCK, POP or normal).

# USE THESE BUTTONS FOR ADDITIONAL OPERATIONS

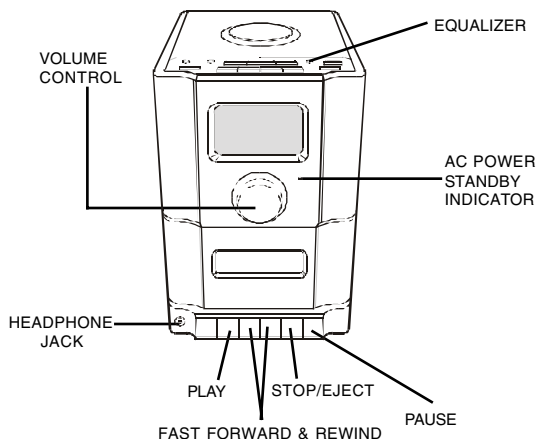

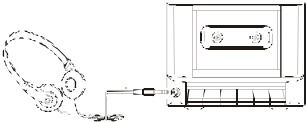
To	Press or Adjust
Adjust the volume	VOLUME control
Get different sound effect	EQUALIZER button
Stop playback	STOP/EJECT button
Fast forward or rewind the tape	FAST FORWARD button or REWIND button
Pause playback	PAUSE button Press again to resume play after pause.
Eject the cassette	STOP/EJECT button
To enjoy the music without disturbing others (Headphones are not included)	Insert your headphone plug into the HEADPHONE Jack 
To shut the player off	Press the POWER switch to OFF, the AC POWER STANDBY INDICATOR will be go on.

# RECORDING ON A TAPE

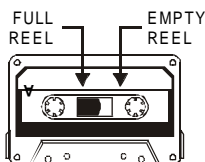
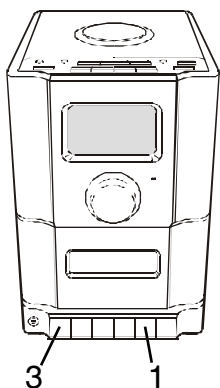

↓  
INSERT THIS WAY

Connect the AC power cord (see page 3).



Press the STOP/EJECT button to open the tape compartment and insert a blank tape. Select the program source (AM, FM or CD) you want to record.

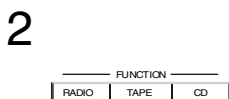

To record from the CD player, insert a CD and follow the steps to play a CD (see page 4).

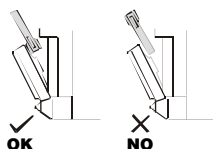

To record from a radio, press the RADIO FUNCTION switch, select AM or FM band and tune into the station you want (see page 8).

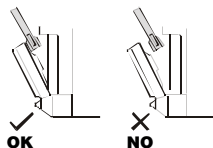

Press the RECORD button to start recording. (The PLAY button is depressed automatically.)

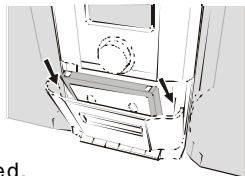

To hear what you recorded, press the TAPE FUNCTION switch, then press REWIND and PLAY.

## USE THESE BUTTONS FOR ADDITIONAL OPERATIONS

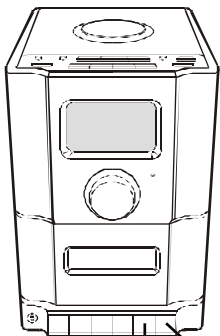

STOP/EJECT PAUSE

### TIP

- To erase a recording, just start a new recording, and the old one is automatically replaced.

To	Press or Adjust
Stop recording	STOP/EJECT button
Pause recording	PAUSE button Press the button again to resume recording.
Turn off the player	Press the STOP/EJECT button and press the POWER switch to off, the AC POWER STANDBY INDICATOR will go on.

**NOTE:** If the PLAY button pops up, your tape may have reached the end, reverse the tape or press REWIND.

# PRECAUTIONS

## On Safety

- As the laser beam used in the CD player section may be harmful to the eyes, do not attempt to disassemble the cabinet. Refer servicing to qualified personnel only.
- Should any solid object or liquid fall into the player, unplug the player, and have it checked by qualified personnel before operating it any further.

## On Placement

- Do not leave the player in a location near a heat source, or in a place subject to direct sunlight, excessive dust or mechanical shock.
- Do not place the player on an inclined or unstable place.
- Do not place anything within 1 inch of the back of the cabinet. The ventilation holes must not be covered for the player to operate properly and prolong the life of its components.
- If the player is left in a car parked in the sun, be sure to choose a location in the car where the player will not be subjected to the direct rays of the sun.
- Since a strong magnet is used for the speakers, keep personal credit cards using magnetic coding or springwound watches away from the player to prevent possible damage from the magnets.

## On Operation

- If the player is brought directly from a cold to a warm location, or is placed in a very damp room, moisture may condense on the lens inside the CD player section. Should this occur, the player will not operate properly. In this case, remove the CD and wait about an hour for the moisture to evaporate. If the player has not been used for a long time, set it in the playback mode to warm it up for a few minutes before inserting a cassette.
- This CD player is designed to be played on a stable no vibration position. If you bump the set or table it is sitting on during CD play, the music will stop or skip for a few seconds. This is normal for this type of player.
- If you have any questions or problems concerning your player, please contact our customer service department at 1-800-315-5885.  
(Monday - Thursday 09:00 AM - 05:00 PM,  
Friday 09:00 AM - 01:00 PM EST)



## PRECAUTIONS (continued)

### Notes on CDs

- Before playing, clean the CD with a cleaning cloth. Wipe the CD from the center out.



- Do not use solvents such as benzene, thinner, commercially available cleaners or anti-static spray intended for vinyl LPs.
- Do not expose the CD to direct sunlight or heat sources such as hot air ducts, nor leave it in a car parked in direct sunlight as there can be a considerable rise in temperature inside the car.
- Do not stick paper or stickers on the CD, nor scratch the CD.
- After playing, store the CD in its case. If there is a scratch, dirt or fingerprints on the CD, it may cause a tracking error or skipping.

### Notes on Cassettes

- Break off the cassette tab from side A or B to prevent accidental recording.

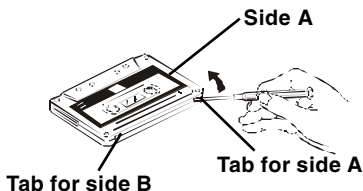

- To record on a tape with its tab broken off, cover the respective tab hole for side A or B with adhesive tape.
- The use of a cassette with more than 90 minutes of play time is not recommended except for long continuous recording or playback.
- To reduce the chances of tape jamming or tangling, you should check that there are no loose layers of tape visible through the cassette center window. If any, tighten these loose layers of tape using a pencil before inserting the cassette into the set.

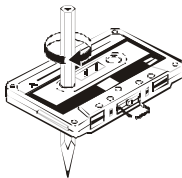

## MAINTENANCE

### Cleaning the Lens

If the lens becomes dirty, it may cause a skipping of sound during CD operation. Clean with a commercially available lens cleaner and blower.

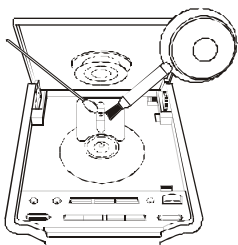

### Notes for Storing Cassette Tapes

1. Do not put a tape near a magnetic field, such as a TV, or speaker. Magnetic fields may reduce the tape sensitivity or even erase the recording.
2. Do not store tape for any length of time in a hot, moist or dusty place.

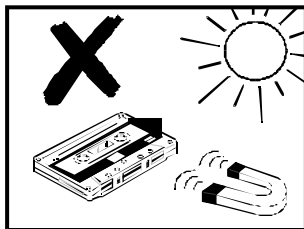

### Cleaning the Tape Heads

Wipe the heads, the pinch roller and the capstan with a cleaning swab slightly moistened with cleaning fluid or alcohol after every 10 hours of operation for optimum playback and recording quality. After cleaning, insert a tape when the areas cleaned are completely dry.

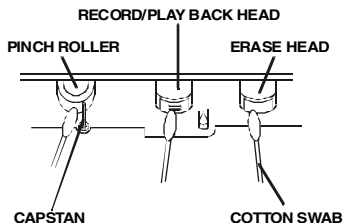

### Cleaning the Cabinet

Clean the cabinet, panel and controls with a soft cloth slightly moistened with a mild detergent solution. Do not use any type of abrasive pad, scouring powder, or solvent, such as alcohol or benzene.

**NOTE:** In order to see and clean the head, you may have to press PLAY first.

# TROUBLE SHOOTING

	Problem	Remedy
<b>General</b>	The power is not on.	<ul style="list-style-type: none"><li>• Connect the AC power cord to a wall outlet securely.</li></ul>
		<ul style="list-style-type: none"><li>• Make sure to press the right FUNCTION switch as you want.</li><li>• Adjust the volume.</li><li>• Unplug the headphones when listening through speakers.</li></ul>
<b>CD player</b>	"no disc" flashes in the display even when a CD is in place.	<ul style="list-style-type: none"><li>• Insert the CD with the label side up.</li></ul>
	CD does not play.	<ul style="list-style-type: none"><li>• Make sure that the CD compartment is closed.</li><li>• Place the CD with the label side up.</li><li>• Clean the CD.</li><li>• Take out the CD and leave the CD DOOR open for about an hour to dry moisture condensation.</li><li>• Make sure the CD FUNCTION switch is pressed.</li></ul>
	The sound drops out.	<ul style="list-style-type: none"><li>• Clean the CD, or replace it if the CD is badly damaged.</li><li>• Place the player in a location free from vibration.</li></ul>
<b>Radio</b>	The sound is weak or has poor quality.	<ul style="list-style-type: none"><li>• Bring the set near a window, or rotate the set.</li></ul>
<b>Tape player</b>	The RECORD button does not function/The tape does not play.	<ul style="list-style-type: none"><li>• Make sure the safety tab on the cassette is in place.</li><li>• Make sure the TAPE FUNCTION switch is pressed.</li></ul>
	The tape does not erase completely.	<ul style="list-style-type: none"><li>• Clean the erasing head (see page 17).</li></ul>
	The tape does not record.	<ul style="list-style-type: none"><li>• Make sure the tape is inserted properly.</li><li>• Make sure the safety tab of the cassette is in place.</li></ul>
	The sound is weak/The sound quality is poor.	<ul style="list-style-type: none"><li>• Clean the heads, pinch roller and capstan (see page 17).</li></ul>
	Cassette PLAY button pops up.	<ul style="list-style-type: none"><li>• The tape has reached its end. Remove it, flip to the other side and re-insert.</li></ul>

# SPECIFICATION

## General Description

Power source:	AC 120V, 60Hz 22Watts		
Speakers:	4" 8 ohm		
Output power:	3.0W/channel		
Dimensions (approx.):	Main set	Speaker	
	Width:	5 7/8"	5 1/8"
	Depth:	9 1/4"	7 3/8"
	Height:	9"	9"
	Weight:	5LBs	3.3LBs

## CD Section

Plays disc type:	Any normal CD used in portable players	
Laser wavelength:	760 - 800 NM	
Tracking method:	3 - spot error detection	3.86 mm lens
Frequency response:	50Hz - 15kHz +1/-2 dB	

## Tape Recorder Section

Frequency response: Standard normal bias cassette tape,  
70Hz - 10kHz

## Radio Section

Frequency range: FM: 87.5 - 108 MHz  
AM: 530 - 1710 kHz

LENOXX reserves the right to make design and specification changes for product improvement.

### PROTECT YOUR FINE FURNITURE!

WE RECOMMEND A CLOTH OR OTHER PROTECTIVE MATERIAL BE PLACED UNDER THE SET WHEN PLACING IT ON SURFACE WITH A NATURAL OR LACQUER FINISH.

## For customer service

**Dial 1-800-315-5885** (MONDAY - THURSDAY 09:00 AM - 5:00 PM, FRIDAY 09:00 AM - 1:00 PM EST)

**or Visit Our Website:** <http://www.lenoxx.com>

© 2000 LENOXX ELECTRONICS CORP.  
2 GERMAK DRIVE  
CARTERET, N.J. 07008  
MADE & PRINTED IN CHINA

## Free Manuals Download Website

<http://myh66.com>

<http://usermanuals.us>

<http://www.somanuals.com>

<http://www.4manuals.cc>

<http://www.manual-lib.com>

<http://www.404manual.com>

<http://www.luxmanual.com>

<http://aubethermostatmanual.com>

Golf course search by state

<http://golfingnear.com>

Email search by domain

<http://emailbydomain.com>

Auto manuals search

<http://auto.somanuals.com>

TV manuals search

<http://tv.somanuals.com>