

Lenox Sound[®]

**13 MEMORY CALL WAITING CALLER ID
SPEAKER TELEPHONE**

MODEL PH-549

OPERATING INSTRUCTIONS

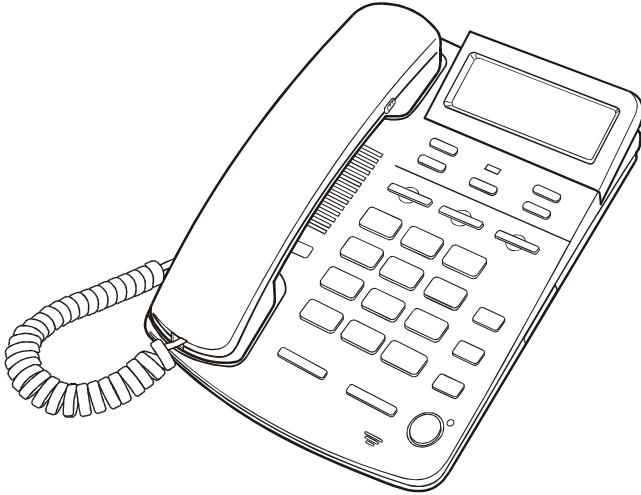

- CALL WAITING CALLER ID FUNCTION*
- 70 NAME & NUMBER CALLER ID MEMORY
- HANDS-FREE SPEAKERPHONE
- TONE/PULSE SWITCHABLE DIALING
- AUTOMATIC TIME & DATE DISPLAY
- ONE-TOUCH CALLER ID CALL BACK
- 3 ONE-TOUCH SPEED DIAL BUTTONS
- 10 TWO-TOUCH SPEED DIAL MEMORY LOCATIONS
- WALL/DESK USABLE
- REQUIRES 4 "AA" BATTERIES OR AC ADAPTOR
(BOTH NOT INCLUDED)

*** TO USE THE CALLER ID AND CALL WAITING FEATURES OF THIS PHONE,
YOU MUST SUBSCRIBE TO CALL WAITING CALLER ID SERVICE FROM
YOUR PHONE COMPANY, AND REMEMBER TO INSTALL BATTERIES**

NOTE: READ AND FOLLOW THESE INSTRUCTIONS BEFORE USING YOUR TELEPHONE

TABLE OF CONTENTS

Important Safety Instructions	1
Battery Safety Instructions	2
Important Telephone Company & FCC Information	3
Location of Controls	4
Getting Started	
Step 1: Checking the Package Contents	5
Step 2: Powering the Phone	6
Step 3: Telephone Installation	7
Step 4: Setting up the Telephone	7
(Reset the phone)	8
Basics	
Choosing Tone or Pulse Dialing	8
Making and Receiving Calls	8
Hands-Free (Speakerphone) Operation	9
Volume Control and Ringer Setting	9
Last Number Redialing and Pause Function	9
Telephone Features	
Memory Dialing	10
Storing Phone Numbers into Memory	10
Making Calls with 3 One-Touch Speed Dialing Buttons	10
Making Calls with 10 Two-Touch Speed Dialing Memory Buttons	10
Caller ID Features	
Understanding the Caller ID Service	11
When you Receive a Call	11
Call Waiting	11
Viewing the Caller ID List	11
Calling back from the Caller ID List	12
Storing the Phone Numbers from the Caller ID List	12
Deleting the Data from the Caller ID List	12
Using Message Waiting/Mailbox	12
Wall Mounting	13
Trouble Shooting	15
Limited Warranty	17

IMPORTANT SAFETY INSTRUCTIONS

When using your telephone equipment, basic safety precautions should always be followed to reduce the risk of fire, electric shock and personal injury, including the following:

1. Read and follow all instructions and warnings.
2. Unplug this product from the wall outlet before cleaning. Do not use liquid cleaners or aerosol cleaners. Use a slightly dampened cloth only.
3. Do not use this product near water, for example, near a bathtub, wash bowl, kitchen sink, or laundry tub, in a wet basement, or near a swimming pool.
4. Do not place this product on an unstable cart, stand or table. The product may fall, causing serious damage to the phone.
5. Slots and openings in back or bottom of the phone are for ventilation, and should not be blocked or covered. The openings should never be blocked by placing the product on the bed, sofa, rug, or other similar surface. This product should never be placed near or over a radiator, heat register or a built-in installation such as a bookcase or cabinet unless proper ventilation is provided.
6. Never push objects of any kind into this product through cabinet slots as they may touch dangerous voltage points or short out parts that could result in risk of fire or electric shock. Never spill liquid of any kind on the product.
7. To reduce the risk of electric shock, do not take this telephone apart. When service or repair work is required, take it to a qualified service representative. Opening or removing covers may expose you to dangerous voltage or other risks. Incorrect reassembly can cause electric shock when the appliance is subsequently used.
8. Unplug this product from the wall outlet and refer servicing to qualified service personnel under the following conditions:
 - A. When the cord or plug is damaged or frayed.
 - B. If liquid has been spilled into the product.
 - C. If the product has been exposed to rain or water.
 - D. If the product does not operate normally by following the operating instructions. Adjust only those controls that are covered by the operating instructions because improper adjustment of other controls may result in damage and will often require extensive work by a qualified technician to restore the product to normal operation.
 - E. If the product has been dropped or the cabinet has been damaged.
 - F. If the product exhibits a distinct change in performance.
9. Avoid using a telephone (other than a cordless type) during an electrical storm. There may be a remote risk of electric shock from lightning.
10. Do not use the telephone to report a gas leak in the vicinity of the leak.
11. Do not allow anything to rest on the telephone cord. Do not locate this product where the cord will be damaged by persons walking on it.
12. Never install telephone wiring during a lightning storm.
13. Never install telephone jacks in wet locations unless the jack is specially designed for wet locations.
14. Never touch uninsulated telephone wires or terminals, unless the telephone line has been disconnected at the network interface.
15. Be careful when installing or modifying telephone lines.

SAVE THESE INSTRUCTIONS

For customer service

Dial 1-800-315-5885 (MONDAY - THURSDAY 9:00 AM - 5:00 PM, FRIDAY 9:00 AM - 1:00 PM EST)

or Visit Our Website: <http://www.lenoxx.com>

BATTERY SAFETY INSTRUCTIONS

CAUTION: TO REDUCE THE RISK OF FIRE OR PERSONAL INJURY, READ AND FOLLOW THESE INSTRUCTIONS.

1. Use only the following type and size of batteries: 4 size "AA" alkaline batteries (not included).
2. Do not dispose of the batteries into a fire. The cells may explode. Check with local codes for possible special disposal instructions.
3. Do not open or mutilate the batteries. Released electrolyte is corrosive and may cause damage to the eyes or skin. It may be toxic if swallowed.
4. Exercise care in handling batteries in order not to short the battery with conducting materials such as rings, bracelets and keys. The battery or conductor may over heat and cause burns.
5. Do not attempt to recharge the batteries that are used with this product. The batteries may leak corrosive electrolyte or explode.
6. Do not attempt to rejuvenate the batteries identified for use with this product by heating them. Sudden release of the battery electrolyte may cause burns or irritation to eyes or skin.
7. All batteries should be replaced at the same time. Mixing fresh and discharged batteries could increase internal cell pressure and rupture the batteries.
8. When inserting batteries into this product, the proper polarity or direction must be observed. Reverse insertion of batteries may result in leakage or explosion.
9. Remove the batteries from this product if the product will not be used for a long period of time (several months or more) since during this time the batteries could leak, damaging the product.
10. Discard weak or dead batteries as soon as possible since they are more likely to leak in the product. Batteries should be replaced when the display gets dim or if the Low Battery Indicator appears in the display.
11. Do not store this product in high temperature areas. Batteries that are stored in a freezer or refrigerator for the purpose of extending shelf life should be protected from condensation during storage and defrosting. Batteries should be stabilized at room temperature prior to use after cold storage.
12. If this product does not operate normally, see TROUBLE SHOOTING on pages 15 and 16. If you cannot resolve the problem, or if the product is damaged, refer to the LENOXX WARRANTY INFORMATION on the last page. Opening or removing covers may expose you to dangerous voltages or other risks. Incorrect reassembly can cause electric shock when the appliance is subsequently used.
13. Installation of batteries should only done by an adult.

SAVE THESE INSTRUCTIONS

IMPORTANT TELEPHONE COMPANY & FCC INFORMATION

**CAUTION : TO REDUCE THE RISK OF FIRE, ELECTRIC SHOCK
AND PERSONAL INJURY, DO NOT OPEN CABINET.**

WE SUGGEST THAT YOU REVIEW THE FOLLOWING INFORMATION PROVIDED BY THE FCC (FEDERAL COMMUNICATIONS COMMISSION).

FCC REGISTRATION

This telephone set is registered with the FCC based upon compliance with Part 68 of its rules. Connection of this telephone to the nationwide telecommunications network must be through a standard network jack (RJ11W or RJ11C) which you can order from your telephone company, if not already installed.

NOTE : FCC registration does not constitute an expressed or implied guarantee of performance. Only the Lennox warranty in this booklet covers the performance of this telephone set.

IMPORTANT FCC INFORMATION

In the event that terminal equipment causes harm to the telephone network, the telephone company should notify the customer, if possible, that service may be stopped. However, where prior notice is impractical, the company may temporarily cease service providing that they:

1. Promptly notify the customer.
2. Give the customer an opportunity to correct the problem with their equipment.
3. Inform the customer of the right to bring a complaint to the Federal Communications Commission pursuant to procedures set out in FCC Rules and Regulations Subpart E of Part 68.

The telephone company may make changes in its communications facilities, equipment, operations or procedures, where such action is reasonably required in the operation of its business and is not inconsistent with the rules and regulations in FCC Part 68. If such changes can be reasonably expected to render any customer terminal equipment incompatible, the customer shall be given adequate notice in writing, to allow the customer an opportunity to maintain uninterrupted service.

RINGER EQUIVALENCE NO. (REN)

The REN is useful to determine the quantity of devices you may connect to your telephone line and still have all of those devices ring when your telephone number is called. In most, but not all areas, the sum of the REN's of all devices connected to one line should not exceed five (5.0). To be certain of the number of devices you may connect to your line, as determined by the REN, you should contact your local telephone company to determine the maximum REN for your calling area.

NOTE :

This equipment has been tested and found to comply with the limits for a Class B digital device, pursuant to Part 15 of the FCC Rules. These limits are designed to provide reasonable protection against harmful interference in a residential installation. This equipment generates, uses, and can radiate radio frequency energy and, if not installed and used in accordance with the instructions, may cause harmful interference to radio communications. However, there is no guarantee that interference will not occur in a particular installation. If this equipment does cause harmful interference to radio or television reception, try the following:

1. Reorient or relocate the receiving antenna.
2. Increase the separation between the equipment and receiver.
3. Connect the equipment into an outlet on a circuit different from that to which the receiver is connected.
4. Consult the dealer or an experienced radio/TV technician for assistance.

GENERAL

The FCC prohibits customer-provided terminal equipment to be connected to party lines or to be used in conjunction with coin telephone service.

This phone is hearing aid compatible.

LOCATION OF CONTROLS

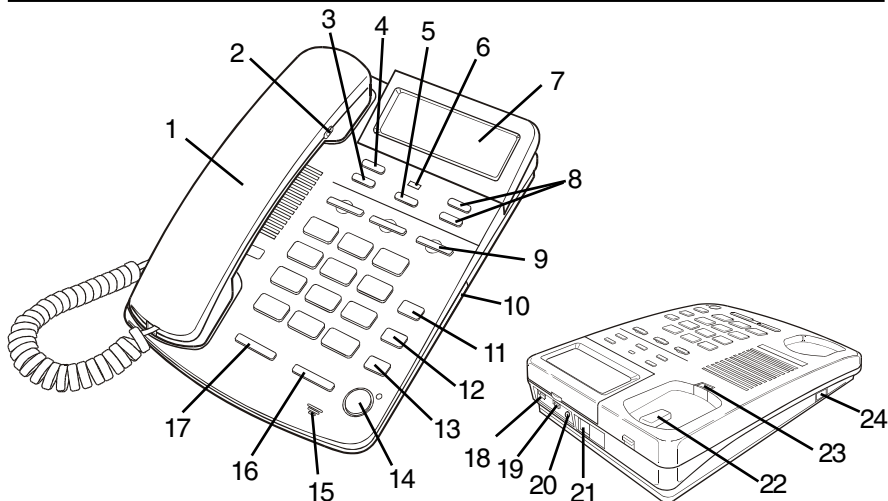

1. COMFORTABLE ROUNDED HANDSET - for comfortable use even during long calls.
2. HANDSET VOLUME CONTROL - adjusts the volume of handset receiver.
3. DIAL BUTTON - dials the number currently displayed.
4. OPTION BUTTON - used for dialing the correct number of digits (7-digits, 10-digits or 11-digits).
5. DELETE BUTTON - erases an individual record or all records from the Caller ID Memory, also used to accept time, date, and area code during initial setup.
6. NEW CALL INDICATOR - flashes when new calls have come in.
7. CALLER ID DISPLAY - shows the caller's name, number, and calling time & date (and more).
8. UP/DOWN BUTTONS - reviews **all** calls received.
9. ONE-TOUCH SPEED DIAL BUTTONS - allows you to store numbers and quickly dial them from memory.
10. SPEAKERPHONE VOLUME CONTROL - adjusts the volume of the speaker.
11. STORE (MEMORY) BUTTON - used for storing numbers into the one-touch or two-touch Speed Dial memories.
12. AUTO (MEMORY) BUTTON - allows you to store & dial numbers from 10 two-touch memory locations.
13. MUTE BUTTON - allows you to hear the other party without them hearing you (while pressed).
14. SPEAKERPHONE - allows you to make or receive a call without lifting the handset.
15. SPEAKERPHONE MICROPHONE - for speakerphone use.
16. REDIAL (PAUSE) BUTTON - get a new dial tone, then press this button to dial the last dialed number (also if you need a pause for PABX).
17. FLASH BUTTON - press to switch calls for call waiting or to get a new dial tone.
18. TONE/PULSE SWITCH - selects the desired dialing mode.
19. RINGER ON/OFF SWITCH - normally on, allows you to turn the ringer off for undisturbed privacy.
20. AC ADAPTOR JACK - allows you to use home AC power supply (6V AC adaptor not included).
21. LINE CORD JACK - insert one end of the telephone line cord here when connecting the telephone.
22. HOOK SWITCH - press down to release the line, hold it down and then release it to get a new dial tone or for call waiting.
23. HANDSET CLIP - holds the Handset in place when the telephone is mounted on a wall.
24. COILED CORD JACK - Insert COILED CORD from HANDSET here.

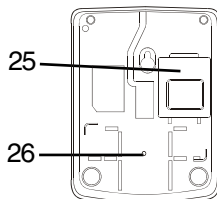

BACK OF THE PHONE

25. BATTERY COMPARTMENT - place 4 size "AA" alkaline batteries inside according to the polarities as shown on the bottom of the phone.
26. RESET SWITCH - to reset your phone by inserting a pin into the small hole on the bottom of the phone.

IMPORTANT

1. To use the Call Waiting Caller ID feature, you must call your local phone company and tell them you want "Call Waiting Caller ID service". After the phone company sets up your line properly, you will be able to see who is calling you before you decide to switch your call to the new caller.
2. If you have regular Caller ID with regular Call Waiting, the Caller ID will only show you the first caller's information, even though your call waiting service works properly.
3. You must tell the phone company you want Call Waiting Caller ID service (both together) in order to have this phone display the second caller even during your conversation to the first caller.

As of today's date most phone companies provide 4 kinds of service:

- A. **CALLER ID** - This shows you who is calling
- B. **CALL WAITING** - This allows you to switch calls when you hear a beep or click.
- C. **CALLER ID AND CALL WAITING** - This will give you Caller ID and also Call Waiting, but your phone will not display the call waiting caller's information.
NOTE: You do not want this service.
- D. **CALL WAITING CALLER ID COMBINED** (or **DELUXE**) is what you want your phone company to set up for you, so that you can see the call waiting caller's information.

GETTING STARTED

Step 1: Checking the Package Contents

Congratulations for purchasing a Lennox Sound telephone. Your new PH-549 Caller ID telephone has all the features of a 13 memory telephone plus Caller ID display and call waiting functions.

As you unpack this set, make sure you have the following items in the package.

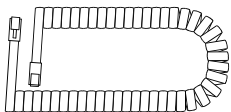

COILED HANDSET CORD

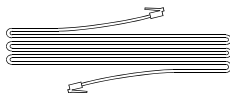

STRAIGHT TELEPHONE LINE CORD



SHORT STRAIGHT WALL CORD
(for wall mounting use)

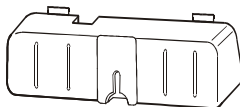

WALL MOUNT ADAPTOR (attach to
the back of the base for wall mounting)

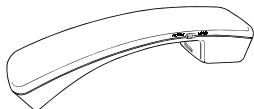

HANDSET

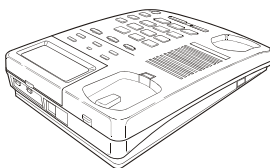

TELEPHONE BASE

GETTING STARTED

Step 2: Powering the Phone

1. USING BATTERIES

Before you connect the phone cords, follow these steps to install the batteries:

1. Insert a flat blade screwdriver or coin like a quarter into the slot and pry out (lift) the battery door (FIG. 1).
2. Insert 4 size "AA" alkaline batteries as shown inside the battery compartment (FIG. 2).
3. Replace the battery door and snap it shut (FIG. 3).

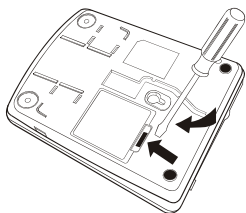

FIG. 1

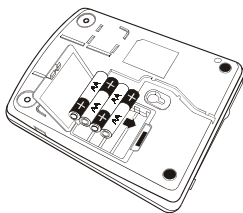

FIG. 2

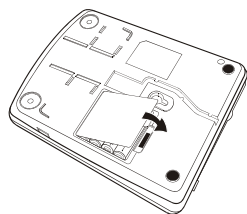



FIG. 3

CAUTION

Replace the batteries when the low battery indicator  appears on the display.

- When the batteries are dead, the display will not show. You can still make or receive calls, but you can't use the Caller ID or memory dialing.
- When the batteries are dead, your data and settings could be erased.

2. USING AC OUTLET POWER (AC Adaptor is optional, not included)

This phone may be powered from any household 120V AC outlet using a 6V AC adaptor (not included). Insert the adaptor's small connector plug into the DC 6V Jack marked  on the rear of the phone, and plug the adaptor into an AC outlet.

NOTE: If the AC Adaptor is connected, and regular batteries are installed, the phone automatically switches to the AC Adaptor power and the batteries are not used.

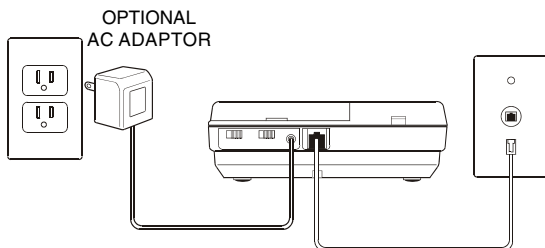

CAUTION:

To prevent electric shock, do not use the AC Adaptor with an extension cord or outlet, unless it can be fully inserted without exposing any part of the blades.

GETTING STARTED

Step 3: Telephone Installation

CONNECTING THE TELEPHONE

1. Connect the handset coiled cord to the **HANDSET** and **side** of the phone.
2. Connect the straight telephone line cord to the **LINE CORD** jack (back of phone) and telephone outlet on the wall.

If your telephone outlet is not modular, contact your telephone company for assistance.

(If you want to mount the telephone on the wall, see Wall Mounting on page 13.)

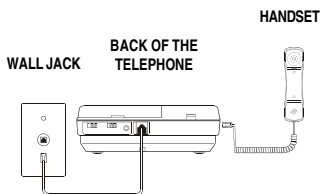

Step 4: Setting up the Telephone

SETTING UP LCD CONTRAST, LANGUAGE, AREA CODE, TIME AND DATE

You may need to set up the LCD contrast level, language, area code, time and date for your telephone when you power your phone for the first time or when you move to an area that has a different area code. This is necessary because the phone must distinguish local or long distance calls to properly dial calls from the Caller ID list.

Press and hold the **DELETE** button down, then press the **DOWN** button, the following will show in the display (FIG. 1). Release the DELETE button, press the UP or DOWN button to choose the LCD contrast level (1-4). Press the DELETE button to confirm and accept. Then the display will come to the language setting.

The default language "E" ("E" = English; "F" = French; "S" = Spanish) will flash (FIG 2).



FIG. 1

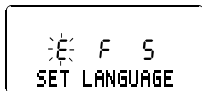

FIG. 2



FIG. 3

Press the UP or DOWN button to choose your desired language (flashing). Press the DELETE button to confirm and accept. If you do not press the DELETE button within 15 seconds, English will be selected automatically.

Then the display will ask you to set your Area Code:

While the first digit is flashing, you should:

1. Press the UP button till the first digit of your area code is displayed (flashing).
2. Press the DELETE button to accept and go to the next digit.
3. Repeat steps 1 and 2 above to set the 2nd and 3rd digits of your area code.

NOTE: At any time during setup, you may just pick up the handset or press the **SPEAKER** button to dial or receive a call.

NOTE: If you make a mistake, you can just do it over again or call customer service for help.

AREA CODE EXAMPLE: 718



Press UP & DELETE to set



Press UP & DELETE to set



Press UP & DELETE to set

GETTING STARTED

Step 4: Setting up the Telephone (Continued)

SETTING UP LANGUAGE, AREA CODE, TIME AND DATE (Continued)

Your phone will now go to the Time and Date mode, press the UP and DOWN buttons to get to the correct number and the DELETE button to accept.

You do not have to set up the Time and Date because the telephone company will automatically update this with your Caller ID when your phone rings (twice or more). To get back to the standby mode (for dialing), press the DELETE button until the normal display shows (see below for example):

(Example: 10:53 a.m. On June 18th)

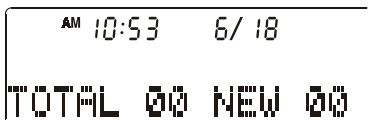

TO RESET THE PHONE

In the rare case of abnormal telephone line interference, your phone may not work properly and may need to be reset. Make sure the phone is hung up, use a pointed object like a straightened paper clip and stick it into the small hole at the bottom of the phone (marked RESET) for 2 seconds. The display will return to the setup mode.

You will need to reprogram the memory numbers you stored.

BASICS

Choosing Tone or Pulse Dialing

Select the type of dialing that you desire or that your telephone system requires by setting the TONE/PULSE switch.

TONE - The set will operate using tone dialing.

PULSE - The set will dial using rotary dial type pulses (clicking sounds).

If you are not sure of your dialing system, make a trial call with the switch set to TONE. If the call connects, leave the switch as it is; otherwise, set it to PULSE.

NOTE: To use caller ID service, you will probably need TONE dialing.

Even when your phone is set to pulse service, this phone can be switched to temporary tone for access to services that require tone signaling including Telephone Banking. Just press the TONE  button after dialing in pulse and your buttons can now be used for tone signaling for **this call only**.

Making and Receiving Calls

MAKING A CALL

1. Pick up the handset to get a dial tone. The hook icon  will show in the display.
2. Dial the phone number. The dialed number appears on the display.
3. When you finished talking, replace the handset into the base.

RECEIVING A CALL

1. Pick up the handset when the phone rings. The hook icon  will show.
2. After a few seconds, the Count up timer will start.
3. When you finished talking, replace the handset into the base.

Hands-Free (Speakerphone) Operation

ANSWERING CALLS WITH THE SPEAKERPHONE

1. After the phone rings twice, press the **SPEAKER** button, the **SPEAKERPHONE INDICATOR** will light, and the hook icon  will show in the display.
2. The display will show the Count Up Call Timer after a few seconds.
3. Adjust the speakerphone volume by sliding the **SPEAKER VOLUME** control on the right side of the phone.
4. To end the call, press the **SPEAKER** button again.
5. The **SPEAKERPHONE INDICATOR** will go off and the display will return to Time and Date mode.

MAKING CALLS WITH THE SPEAKERPHONE

1. Press the **SPEAKER** button to get a dial tone - no need to lift the handset.
2. The **SPEAKERPHONE INDICATOR** will light and the hook icon  will show in the display, the Count Up Timer will start after a few seconds.
3. Adjust the speakerphone volume by sliding the **SPEAKER VOLUME** control on the right side of the phone.
4. Dial your call.
5. To end the call, press the **SPEAKER** button again.
6. The **SPEAKERPHONE INDICATOR** will go off and the display will return to Time and Date mode.

NOTE: When pick up the **HANDSET** or press the **SPEAKER** button, the hook icon  will show in the display. If this icon shows in the display while the phone is not in use, remember to check if the **HANDSET** is replaced properly or the **SPEAKER** button is pressed to off.

Volume Control and Ringer Setting

Adjust the handset volume	Slide the HANDSET VOLUME control (LOUD or NORMAL).
Adjust the ringer ON or OFF	Set RINGER ON/OFF switch. ON - Normal setting, the phone rings on incoming calls. OFF - To turn off the ringer, for undisturbed privacy. NOTE: Only this phone will not ring, other phones on the same line will continue to ring normally.

If you have subscribed to the Caller ID service, the caller's number and/or name appears on the display when you received a call (see page 11).

Last Number Redialing and Pause Function

1. Pick up the **HANDSET** or press the **SPEAKERPHONE** button. The hook icon  will show in the display.
2. Press the **REDIAL** button. The last dialed number appears in the display and is automatically dialed.

TO CHECK THE LAST PHONE NUMBER DIALED

While the handset is on the base, press the **REDIAL** button. The number appears in the display for 3 seconds.

NOTE: If the last dialed number exceeds 16 digits, only 16 digits will be displayed.

PAUSE FUNCTION

(Example: In an office where you need to dial a 9 first to get an outside line), dial the number 9 and press **REDIAL** button, and then dial the phone number. You will see a "P" displayed for pause. You may also store this into memory.

TELEPHONE FEATURES

Memory Dialing

You can quickly dial the numbers you stored into the 3 one-touch speed dial buttons or 10 two-touch speed dial memories.

STORING PHONE NUMBER INTO MEMORY

1. Press the STORE button. **PRG** (short for programming) appears on the display.
2. Dial the phone number you want to store. You can store up to 22 digits (including a TONE (*****) and a PAUSE (**REDIAL**), each of which is counted as one digit).

3. For 3 one-touch dialing:

Press one of the 3 one-touch speed dial buttons (M1 to M3).

For 10 two-touch dialing:

Press AUTO button, and then press one of the dialing keys (0 to 9) to store a phone number in.

4. The stored number and the location will be shown in the display.
5. Press the STORE button or wait 3 seconds to resume normal display.
6. Repeat steps 1 to 5 to store numbers into other memory locations.

NOTE

When the batteries are dead or removed for more than five minutes, the stored numbers may be erased.

TIP: If you entered a wrong number, you may press the STORE button, then start from the beginning.

To store a number to be dialed via Private Branch Exchange (PABX)

Before entering a phone number in Step 2 in *Storing phone number into memory*, do as follows:

1. Enter the outside line access digit (e.g., 9).
2. Press REDIAL button (for a pause).

To check the stored number

While the handset is on the base, press the desired one-touch speed dial button, or press the AUTO button and the desired two-touch memory number (0 to 9). The stored number appears on the display for 3 seconds.

To change a stored number

Just store a new number, as described above, the old number will be erased automatically.

MAKING CALLS WITH 3 ONE-TOUCH SPEED DIALING BUTTONS

1. Pick up the handset or press the SPEAKER button.
2. Press one of the one-touch speed dial buttons (M1 to M3).
3. The phone will dial the numbers you stored into it.

MAKING CALLS WITH 10 TWO-TOUCH SPEED DIALING LOCATIONS

1. Pick up the handset or press the SPEAKERPHONE button.
2. Press the AUTO button first.
3. Press the desired two-touch memory number (0 to 9).

CALLER ID FEATURES

Understanding the Caller ID Service

Caller ID allows the caller's phone number to be shown on the display after the second ring of the call, also in most cases, the caller's name, and calling time and date. This information will be stored automatically.

In order to use this feature, you must first subscribe to Caller ID service (see page 5). To use the call back feature, be sure to enter your area code (see page 7), and press the OPTION button for correct digits.

When You Received a Call

The phone number appears on the display with the date and time as shown in the example here.

If your Caller ID service includes the caller's name, the caller's name also appears on the display (up to 16 letters), as well as time & date of the call (this varies by region).

PM	1:54	3/19	CALL# NEW 28
2 12-555-1234			
JOHN SMITH			

NOTE

The caller's phone number and/or name will not appear in the following cases:

- The call is made through a telephone company which does not offer Caller ID service (including international calls). The display will show "OUT OF AREA" or "UNAVAILABLE".
- The call is "blocked". For privacy reasons, many states allow callers the option to prevent his or her telephone data from being displayed on the other party's Caller ID display. The display will show "PRIVATE CALL".
- You have picked up the phone before second ring.
- If the call is from an office which uses multiple lines, the displayed phone number may not match the number you use to call that extension.

Call Waiting

This feature allows you to read from the LCD display the incoming call information while you are using the telephone. If you are using the telephone when a new call comes in, "CW" will be flashing on the LCD, and the phone number of the new caller will appear on the LCD. By pressing the FLASH button on your telephone, you will put on hold the party you are having the conversation with and you will be able to talk to the new caller, and the "CW" icon disappears from the LCD. After you finish the conversation with the 2nd caller, press FLASH to return to the 1st call (you may also press the HOOK switch for 2 seconds).

NOTE

Remember to subscribe to CALL WAITING CALLER ID service from your telephone company (see page 5).

Viewing the Caller ID List

The phone stores the data of the last 70 calls received including "OUT OF AREA" or "UNAVAILABLE" and "PRIVATE CALL" calls. It keeps track of all calls received, even if they were not answered (for example, if you are not at home).

You can look through the data in the Caller ID list to check the numbers and names of the calls received.

1. Press the DOWN button to view your calls from the newest call.
2. Press the UP button to view calls from older calls to newer ones.
 - When you have reached the last (newest) data by pressing UP button, "END OF LIST" appears. If you press UP button again, the display will show the first (oldest) call.
 - When you have reached the first (oldest) data by pressing DOWN button, "END OF LIST" appears. If you press DOWN button again, the display will show the last (newest) call.

You can view the Caller ID list during conversation also by following the steps above.

NOTE: If your telephone is powered by batteries, when the batteries are weak, the low battery indicator  is displayed. Change the batteries as soon as possible; otherwise the Caller ID list may be erased.

CALLER ID FEATURES

Calling Back From the Caller ID List

1. Display the phone number you want to call back using the UP or DOWN button.
2. Press the DIAL button, the phone number will show on the display.
3. Press the OPTION button to choose the number of call-back digit to be dialled out (7 digits - phone number by itself, or 10 digits - area code + phone number, or 11 digits - 1 + area code + phone number), different parts of the country have different dialing systems even for local calls.
4. Pick up the HANDSET or press the SPEAKERPHONE button.
5. Press the DIAL button, the phone will dial the number displayed.

Storing the Phone Numbers from the Caller ID List

As the phone keeps the data of up to 70 calls, if the 71st call comes in, the phone deletes the oldest data automatically.

To prevent important data from being deleted, you can store them into the 13 speed dial memories (3 one-touch or 10 two-touch).

1. Display the phone number you want to store (by pressing UP or DOWN button).
2. Press STORE button. The call number is repeated in the display.
3. Press the OPTION button to change the memory dial digit (7-digit, 10-digit or 11- digit).

4. For one-touch memory

Press a one-touch speed dial button (M1 to M3).

For two-touch memory

Press the **AUTO** button, and then one of the speed dial memories (**0 to 9**).

The phone number is now stored in that memory button (NOTE: Only the number will be stored, not the name).

NOTE:

1. Do not allow more than 3 seconds to elapse between each step of the procedure.
2. If the phone is connected to a Private Branch Exchange (PABX), you may need to add an outside line access digit or a pause, see page 10.

Deleting the Data from the Caller ID List

To delete the Caller ID memory one by one

1. Display the Caller's ID you want to delete (by pressing UP or DOWN button).
2. Press the DELETE button **quickly twice**, the display changes to show the next or previous call, and the data is deleted.



To delete **ALL** the Caller ID memories

1. Press the UP or DOWN button to display any call, make sure the display does not show "END OF LIST".
2. Press and hold the DELETE button down for 6 seconds. Display changes to "NO CALLS" and **all** the Caller ID memories are deleted.

Using Message Waiting/Mailbox

To use the Message Waiting indication feature, you must subscribe to this service if available from your local telephone company.

Your PH-549 will only respond to FSK type of message delivery.

1. If the message is sent by the telephone company which is preceded by a ring, the message waiting symbol  will appear on the display, and the NEW CALL INDICATOR will flash.
2. After you have retrieved your message(s), the telephone company will send a clear signal (by a ring) to your phone. The message waiting symbol  and the NEW CALL INDICATOR will turn off, and display shows "MSG WAITING OFF".
3. Sometimes the telephone company will not send a message clear signal to you, and you have to clear the message waiting record manually. Just press and hold the DELETE button down and then press the UP button, the message will be cleared. The message waiting symbol  and NEW CALL INDICATOR will be off.

WALL MOUNTING

Your PH-549 can be mounted on a wall phone plate. If you do not have a modular wall phone plate installed, please consult with your phone company or installer to get one, or see next page for installation without a wall plate.

1. **HANDSET CLIP** - When the phone is mounted on the wall, the **HANDSET CLIP** must be adjusted so it will hold the **HANDSET**.

A. SLIDE OUT

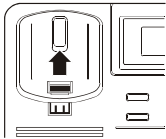

B. REVERSE

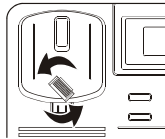

C. REPLACE INTO PHONE

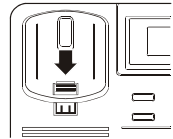

2. To use as a wall phone, you must use the plastic (box shape) **WALL MOUNT ADAPTOR**.

FOR WALL USE, PUT ADAPTOR HERE

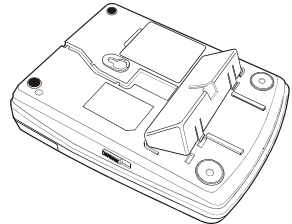
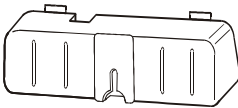

3. Use the **SHORT STRAIGHT WALL CORD**, and plug one end into the rear of the phone. Route the cord into the channel at the phone bottom.

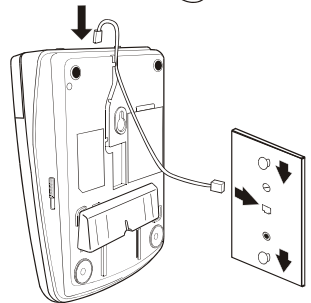

4. Plug the other end of the **SHORT STRAIGHT WALL CORD** into the **WALL JACK**.

5. Put the phone over the **WALL PLATE**, make sure both posts fit into slots on the back of the phone. Then slide the phone down to lock the phone onto the **WALL PLATE**.

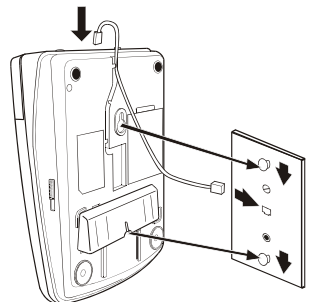

WALL MOUNTING (continued)

Wall Mounting Without A Modular Wall Phone Plate

Follow these instructions to mount the phone on the wall without a wall plate:

1. Locate a wall stud. If it is possible to utilize a wall stud for mounting, dry wall expanders or a similar type fastener is recommended. Consult your local hardware stores for details.
2. Drill 2 holes $3\frac{15}{16}$ " (100 mm) apart.
3. Put a screw into each hole and leave $\frac{3}{16}$ " (5mm) of the head exposed to mount the phone (screws are not included).
4. Connect the straight cord to the phone and jack.
5. Place the TELEPHONE BASE on the 2 mounting screws and gently push down to lock into place.

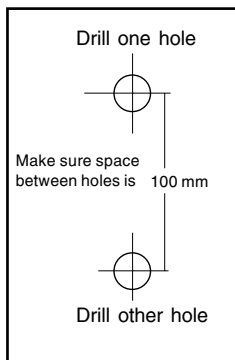

IMPORTANT

Before mounting the phone onto the wall, select a wall area with sufficient strength. If mounting on the wallboard or in an area of questionable strength, locate a stud for maximum support of your telephone.

Installation on Masonry

1. Use a $\frac{1}{4}$ " masonry drill bit and drill the 2 holes (spaced as above).
2. Insert plastic anchors and install the 2 screws.
3. Leave $\frac{3}{16}$ " (5 mm) of the screws exposed to mount the phone.
4. Place the TELEPHONE BASE on the 2 mounting screws and gently push down to lock into place (anchors and screws are not included).

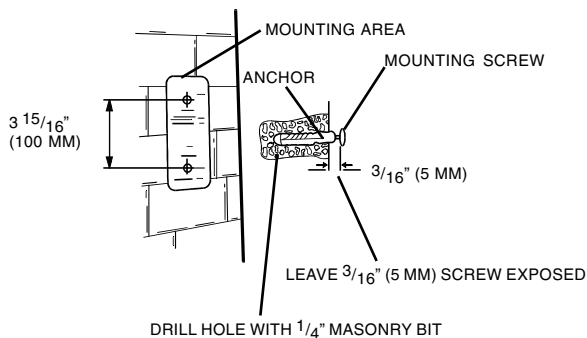

TROUBLE SHOOTING

PROBLEMS	CHECK
The Caller ID display does not show the caller's information	The Caller ID unit will not function until you have subscribed the Caller ID service from your local telephone company. Call your local telephone company to have Call Waiting Caller ID service installed on your phone line. Check your phone line connections. Also, fresh batteries MUST be installed. Make sure all your phone line connections are secure and corrected. If it is a private call or a blocked call, the caller's name and/or phone number will not appear on the display. (You will see time & date of call plus some dashes or the words " OUT OF AREA ", " UNAVAILABLE " or " PRIVATE CALL ".)
No dial tone	Is any plug disconnected from the modular phone plug? Is any jack improperly wired? Use another phone to test the jack.
Phone does not work	Are all cords connected properly? Are all 4 "AA" batteries installed? Make sure they are installed according to the polarity shown.
Phone does not ring	RINGER switch may be set to OFF? Slide the switch to ON position.
Cannot dial	Check the TONE/PULSE switch setting. You may only have PULSE service. Set the TONE/PULSE switch to PULSE position.
Display showing erroneous figures OR No dial tone or low dial tone OR Can not dial out	Reset the phone. Make sure the phone has hung up, use a pointed object like a straightened paper clip and stick it into the small hole on the bottom of the phone (marked RESET) for 2 seconds. After that reset the language and Area Code as shown in Page 7.
Cannot store numbers into memory	No batteries are installed or batteries are weak or installed up-side-down.
Caller ID does not work	Make sure the Caller ID service is active. Check if the phone is connected to a working wall jack. Check if all line cord connections are correct and secure.
The Caller ID display gets dim Or is blank	Reset the contrast level of the LCD display. Check if batteries are properly installed. Check if you have received the first Caller ID record. If you have received the first Caller ID record, your batteries may be weak.
Static noise on line or cannot hear calling party or calling party cannot hear you	Make sure the handset cords connected properly. Or, replace the COILED HANDSET CORD. Any phone store has these cords in different lengths. After some time the cord may have become overstretched or damaged.
REDIAL does not work	Check if P shows in the display. Since the REDIAL button has combined function (pause function), the phone may have been paused. Just press the HOOK switch.
Feedback or squealing when using SPEAKERPHONE	Volume is too high. Reduce the SPEAKERPHONE VOLUME control setting.

NOTE: This phone will also work on regular (not Call Waiting) Caller ID service or if you don't like Caller ID service, you may use this as a regular telephone.

TROUBLE SHOOTING (continued)

PROBLEMS	CHECK
LINE ERROR appears on the display	You picked up the phone before the second ring, or your phone received unclear call information. Static can cause this message. If this condition persists, contact your local telephone company to ensure that there is no problem with your phone line.
Cannot erase all records in memory	The DELETE button must be quickly pressed twice to erase a single call record. To erase ALL call records, display any record using the UP or DOWN button, then press and hold the DELETE button for about 6 seconds.
Call waiting does not show the number	If an extension phone was pickup up on call 1, this phone will not decode the call waiting, Caller ID signals, if the extension phone is not a call waiting caller ID phone.
Caller ID displays words like CHOISIR ZONE, CODIGO DEL AREA or HEURE or APPEL or TIEMPO.	Your language is set for French or Spanish. To reset the language, press and hold the DELETE button down, the display will go to the contrast level setting, press delete again then press the DOWN button. When E is flashing, press DELETE button to confirm. The language will be set to English mode.
Memory Dialing does not work	Check if you have stored the numbers correctly by pressing that memory location button(s). Also numbers can only be stored when fresh batteries are installed correctly.
Handset falls out of phone base when wall mounted	Handset clip was not installed properly for wall use. See page 13 for details.
Caller's information is not registered to the Caller ID memory	The caller may have an unlisted or blocked number to prevent Caller ID identification, or it may be an overseas call or you may have noise on the line during that call.
Call Waiting or Message Waiting does not work	Check with your telephone company if this service is available and if you have subscribed for it.
Pressing a Memory button does not display number	Your MEMORY button has no stored number. Please store the number again. Press the STORE button, dial the number and press the MEMORY locations you want.

NOTE :

- If problems with your telephone service occur later, try to determine if the trouble is with the telephones you own or with the telephone company equipment. Unplug the telephone and try it on another jack in a different room or in a neighbor's home to see if the phone line is bad or the phone.
If the known working phone does not operate properly on that line, contact your local telephone company for assistance.
- If disconnection of your phone ends the problem, your phone may be the source of the trouble and it should be tested and repaired if necessary before it is re-connected.
- There are no user maintainable parts or adjustments on this set. Should your phone require repairing, contact the manufacturer for instructions (except for cords which you can buy at any phone store).

LIMITED WARRANTY

We warrant this product to be free from defects in material and workmanship under normal use for a period of 1 year after purchase, and we will repair it free of charge or replace it at no charge, should it become defective under this warranty, providing you submit proof of purchase sales slip with the set.

During the initial 1 year period after original purchase, we will service the set that is returned to LENOXX ELECTRONICS CORP., prepaid, at no charge. After the initial 1 year period expires, we will exchange, at no charge, any part that is defective, but will charge for the cost of labor, return postage paid by LENOXX.

This warranty does not apply to any products which have been subject to misuse, neglect or accident. This warranty does not cover broken cords or cabinet. UNDER NO CIRCUMSTANCES WILL LENOXX ELECTRONICS CORP. BE LIABLE FOR ANY INCIDENTAL OR CONSEQUENTIAL DAMAGES. Some states do not allow the exclusion or limitation of incidental or consequential damages, so the above exclusions or limitations may not apply to you.

This warranty gives you specific legal rights, and you may also have other rights which vary from state to state. The following charges apply to repairs beyond the warranty period: \$12.00. Be sure to pack carefully and send postage paid and insured with your money order (personal checks will not be accepted) and proof of purchase date to:

LENOXX ELECTRONICS CORP., 2 GERMAK DRIVE, CARTERET, N.J. 07008

For customer service

Dial 1-800-315-5885 (MONDAY - THURSDAY 9:00 AM - 5:00 PM, FRIDAY 9:00 AM - 1:00 PM EST)

or Visit Our Website: <http://www.lenoxx.com>

© 2000 LENOXX ELECTRONICS CORP.
2 GERMAK DRIVE
CARTERET, N.J. 07008
MADE & PRINTED IN CHINA

Free Manuals Download Website

<http://myh66.com>

<http://usermanuals.us>

<http://www.somanuals.com>

<http://www.4manuals.cc>

<http://www.manual-lib.com>

<http://www.404manual.com>

<http://www.luxmanual.com>

<http://aubethermostatmanual.com>

Golf course search by state

<http://golfingnear.com>

Email search by domain

<http://emailbydomain.com>

Auto manuals search

<http://auto.somanuals.com>

TV manuals search

<http://tv.somanuals.com>