



911 Carrera

Owner's Manual

WKD 997 021 10

5/09

© Dr. Ing. h.c. F. Porsche AG

Porsche, the Porsche crest, 911, Carrera, Targa, PCCB, PCM, PDK, PSM and Tequipment are registered trademarks and the distinctive shapes of Porsche automobiles are trademarks of Dr. Ing. h.c. F. Porsche AG.

All rights reserved.

Printed in Germany

Orientation guides in the Owner's Manual

The orientation guides in the Owner's Manual are highlighted in yellow.

Overall Table of Contents

At the start of the Owner's Manual you will find an overview of the overall contents of the Owner's Manual.

Section Contents

There is a summary of topics with the corresponding page numbers at the beginning of each main chapter.

Index

There is a detailed, alphabetical index at the end of this Owner's Manual.

Dear Owner,

We would like to thank you for your purchase of a Porsche Sports car.

Judging by the car you have chosen, you are a motorist of a special breed, and you are probably no novice when it comes to automobiles.

Remember however, as with any vehicle, you should take time to familiarize yourself with your Porsche and its performance characteristics. Always drive within your own unique capabilities as a driver and your level of experience with your Porsche. Ensure that anyone else driving your Porsche does the same. To prevent or minimize injury, always use your safety belts. Never consume alcohol or drugs before or during the operation of your vehicle.

This Owner's Manual contains a host of useful information. Please take the time to read this manual before you drive your new Porsche. Become familiar with the operation of your Porsche car for maximum safety and operating pleasure. The better you know your Porsche, the more pleasure you will experience driving your new car. Always keep your Owner's Manual in the car, and give it to the new owner if you ever sell your Porsche.

A separate **Maintenance Booklet** explains how you can keep your Porsche in top driving condition by having it serviced regularly.

A separate **Warranty and Customer Information Booklet** contains detailed information about the warranties covering your Porsche.

For U.S. only:

If you believe that your vehicle has a fault which could cause a crash, injury or death, you should immediately inform the National Highway Traffic Safety Administration (NHTSA) in addition to notifying Porsche Cars North America, Inc. (Porsche Cars N.A.).

If NHTSA receives similar complaints, it may open an investigation, and if it finds that a safety problem exists in a group of vehicles, it may order a recall and remedy campaign. However, NHTSA cannot become involved in individual problems between you and your dealer, or Porsche Cars N.A..

To contact NHTSA, you may call the Vehicle Safety Hotline toll-free at 1-888-327-4236 (TTY: 1-800-424-9153); go to <http://www.safercar.gov>; or write to: Administrator, NHTSA, 400 Seventh Street, SW., Washington, DC 20590.

You can also obtain other information about motor vehicle safety from <http://www.savercar.gov>.

Your car has thousands of parts and components which have been designed and manufactured in accordance with Porsche's high standards of engineering quality and safety.

Warning!

Any alteration or misuse of the vehicle can lead to accidents and severe or fatal personal injuries.

Any alteration of the vehicle may negate or interfere with those safety features built into the vehicle. Modifications may be carried out on your vehicle only if approved by Porsche. Your Porsche is intended to be used in a safe manner obeying the local laws and in the light of driving conditions faced by you, and in accordance with the instructions provided in this Owner's Manual.

- f Do not misuse your Porsche by ignoring those laws and driving conditions, or by ignoring the instructions in this manual.

Caution!

The fitting of racing tires (e.g. slicks) for sporting events is not approved by Porsche. Very high cornering speeds can be achieved with racing tires. However, the resulting transverse acceleration values would jeopardize the adequate supply of oil to the engine. Porsche therefore will not accept any warranty or accept any liability for damage occurring as a result of non-compliance with this provision.

- f Do not fit racing tires (e.g. slicks) for sporting events on your vehicle.

Regularly check your vehicle for signs of damage.

Damaged or missing aerodynamic components such as spoilers or underside panels affect the driving behavior and therefore must be replaced immediately.

Your car may have all or some of the components described in this manual.

Should you have difficulty understanding any of the explanations of features or equipment installed in your vehicle, contact your authorized Porsche dealer. He/She will be glad to assist you. Also check with your dealer on other available options or equipment.

Throughout this booklet, left is designated as the driver's side of the vehicle, and right as the passenger's side of the vehicle.

Text, illustrations and specifications in this manual are based on the information available at the time of printing.

It has always been Porsche's policy to continuously improve its products. Porsche, therefore, reserves the right to make changes in design and specification, and to make additions or improvements in its product without incurring any obligation to install them on products previously manufactured.

We wish you many miles of safe and pleasurable driving in your Porsche.

Warning!

For your own protection and longer service life of your car, please follow all operating instructions and special warnings. These special warnings use the safety alert symbol, followed by the words **Danger, Warning and Caution**. These special warnings contain important messages regarding your safety and/or the potential for damage to your Porsche. Ignoring them could result in serious mechanical failure, serious personal injury or death.

- f Do not alter your Porsche. Any alteration could create dangerous conditions or defeat safety engineering features built into your car.
- f Do not misuse your Porsche. Use it safely, and consistently with the law, according to the driving conditions, and the instructions in this manual.

Alteration or misuse of your Porsche could cause accidents and serious personal injury or death.

Note to owners

In Canada, this manual is also available in French. To obtain a copy contact your dealer or write to:

Note aux propriétaires

Au Canada on peut se procurer un exemplaire de ce Manuel en français auprès du concessionnaire ou du:

Porsche Cars Canada, Ltd.
Automobiles Porsche Canada, LTEE

5925 Airport Road
Suite 420
Mississauga, Ontario
Canada L4V 1W1

Telephone number for customer assistance:
1-800-PORSCHE / Option 3

Sport tires

Sport tires (ultra high performance tires) are approved for use on public highways and comply with all statutory requirements and safety criteria.

The design of the tire is also geared towards use on racing circuits (driver safety training courses, sports driving schools, Club Sport events) and provides distinct advantages here in terms of dry grip and wear compared to conventional road tires.

The major features are a reduced tread depth and a special tread pattern and carcass.

The design features of this sports tire result in the following effects compared with other summer tires when used under normal driving conditions:

- Sport tires have a smaller tread depth, and thus can reach their wear limit sooner. As with all tires, the attainable mileage depends on the individual driving style and the conditions of use.
- Exercise caution when driving on wet roads, paying special attention to hydroplaning situations (stagnant water, puddles, lane grooves). Sport tires have a lower tread depth than normal tires and you must therefore adapt speed accordingly when driving on wet surfaces.

- The driver's skill level must be commensurate with the vehicle performance levels in the upper range limits, due to increased safety risks in the upper range limits.

f At outside temperatures below 45 °F (7 °C) change to snow tires.

f Notify anyone using your car of these characteristics and possible effects.



Risk of accident through loss of road surface contact, control over the vehicle and braking ability, leading to serious personal injury or death.

The reduced tire tread depth means that there is an increased risk of aquaplaning on wet roads.

f When driving on wet or mud-covered roads reduce speed significantly.



Risk of accident from worn tires.

Sport tires have a smaller tread depth, and thus can reach their wear limit sooner. It is important to check tire wear frequently to avoid risk of serious personal injury or death from worn tires.

f Check tire wear frequently.

Porsche Ceramic Composite Brake (PCCB)

f Please see the chapter "BRAKES" on Page 58.

The high-performance brake system is designed for optimal braking effect at all speeds and temperatures.

Certain speeds, braking forces and ambient conditions (such as temperature and humidity) therefore might cause brake noises.

Wear on the different components and braking system, such as brake pads and brake discs, depends to a great extent on the individual driving style and the conditions of use and therefore cannot be expressed in actual miles on the road.

The values communicated by Porsche are based on normal operation adapted to traffic. Wear increases considerably when the vehicle is driven on race tracks or through an aggressive driving style.

f Please consult an authorized Porsche dealer about the current guidelines in effect before such use of your vehicle.

Setting and operating vehicle components when driving

Warning!

There is a danger of accident if you set or operate the on-board computer, radio, navigation system, telephone or other equipment when driving.

This could distract you from the traffic and cause you to lose control of the vehicle resulting in serious personal injury or death.

- f Operate the components while driving only if the traffic situation allows you to do so safely.
- f Carry out any complicated operating or setting procedures only with the vehicle stationary.

Portable Fuel Containers

Danger!

Portable fuel containers may leak, whether they are full or partially empty. Fuel leaking from a portable container carried in your vehicle could, in case of an accident, cause a fire or explosion, resulting in serious personal injury or death.

- f Never carry additional fuel in portable containers in your vehicle.

Ground Clearance

Caution!

Risk of damage. The vehicle may touch the ground as a result of reduced ground clearance.

- f Drive carefully and slowly on steep slopes (e.g. parking lots, curbs, uneven roads, lifting platforms etc.).
- f Avoid steep ramps.

Engine Exhaust

Danger!

Engine exhaust is dangerous if inhaled. Engine exhaust fumes have many components which you can smell. They also contain carbon monoxide (CO), which is a colorless and odorless gas.

Carbon monoxide can cause unconsciousness and even death if inhaled.

- f Never start or let the engine run in an enclosed, unventilated area. It is not recommended to sit in your car for prolonged periods with the engine on and the car not moving.

California Proposition 65 Warning

Warning!

Engine exhaust, some of its constituents, and certain vehicle components contain or emit chemicals known to the State of California to cause cancer and birth defects or other reproductive harm. In addition, certain fluids contained in vehicles and certain products of component wear contain or emit chemicals known to the State of California to cause cancer and birth defects or other reproductive harm.

Hot Exhaust Pipes

Warning!

Risk of burn injury when standing near or coming into contact with the exhaust pipe.

The exhaust pipe is hot when the vehicle is running and remains hot for some time after the vehicle is turned off.

- f To prevent injury, make a point of noting where your vehicle's exhaust pipe is, avoid placing your legs near the exhaust pipe, and closely supervise children around the vehicle when the exhaust pipe could be hot. A hot exhaust pipe can cause serious burns.

Table of Contents

Sport tires.....	4	LATCH System		Storage in the Passenger Compartment	91
Porsche Ceramic Composite Brake (PCCB).....	4	Child seat bracket on the passenger's seat	54	Luggage Compartment Lid and	
Setting and operating vehicle components		Child Restraint Anchorages	55	Engine Compartment Lid	93
when driving	5	Rollover Protection System	56	Luggage Compartment (Vehicles without	
Ground Clearance	5	Sports Exhaust System	57	Porsche Traction Management PTM).....	95
Before driving off... ..	8	Parking Brake	57	Luggage Compartment (Vehicles with	
Break in hints for the first		Brakes	58	Porsche Traction Management PTM).....	96
2,000 miles/3,000 kilometers.....	10	ABS Brake System (Antilock Brake System)....	61	Trunk Entrapment.....	97
		Clutch Pedal	62	Porsche Communication Management (PCM) .	98
Operation, Safety.....	13	Porsche Traction Management (PTM).....	63	Car Telephone and Aftermarket Alarms	100
Keys	15	Sport Mode	64	iPod, USB and AUX.....	101
Security Wheel Bolts	15	Porsche Stability Management (PSM).....	66	Fire Extinguisher	102
Doors	18	Porsche Active Suspension Management		HomeLink	103
Central Locking	19	(PASM)	69		
Alarm System,		Retractable Rear Spoiler.....	69	Automatic Air Conditioning System,	
Passenger Compartment Monitoring	23	Interior Lights	71	Heated Rear Window/	
Power Windows	25	Parking Aids	72	Door Mirror Heating.....	105
Mirrors.....	27	Ignition/Starter Switch with		Automatic Air Conditioning System	106
Rear Window Defogger, Door Mirror Heating ..	29	anti-theft Steering Lock.....	74	Central and Side Vents.....	109
Seat Adjustment and Head Restraints	30	Starting Procedures	77	Fresh-air Intake	109
Seat Memory.....	33	Stopping Engine.....	78	Heated Rear Window/Door Mirror Heating ...	110
Heated Seats	35	Emergency Flasher Switch	79		
Seat Ventilation.....	36	Light Switch.....	80	Instruments, On-Board Computer,	
Rear Seat Backrests	37	Welcome Home Lighting	81	Warnings	111
Steering Wheel Adjustment	37	Automatic Headlight Beam Adjustment.....	81	Instrument Panel USA Models.....	112
Steering Wheel Heating	38	Turn Signal / Headlight Dimmer /		Instrument Panel Canada Models	114
Multi-Functional Steering Wheel	39	Parking light / Flasher Lever	82	Engine Oil Temperature.....	116
Sun Visors.....	40	Windshield Wiper / Washer Lever	83	Automatic Speed Control Indicator light	116
Safety Belts.....	41	Automatic Speed Control	86	Instrument Illumination	116
Airbag Systems	44	Cupholder	88	Trip Odometer.....	117
Child Restraint Systems.....	50	Ashtray	89		
		Cigarette Lighter.....	90		

Speedometer	118	Maintenance, Car Care	205	Lifting the Vehicle with a Lifting Platform or	
Changing over between Miles / Kilometers ..	118	Exercise Extreme Caution when Working		Garage Lift	254
Tachometer	119	on your Vehicle	206	Spacers 911 Carrera, 911 Carrera S	255
Turn Signal Indicator Light	119	Coolant Level.....	207	Electrical System	257
High Beam Indicator Light.....	119	Engine Oil.....	208	Battery.....	261
Gear Shift Indicator "A"		Engine Oil Level	208	Replacing the remote-control battery	266
(in vehicles with manual transmission).....	119	Engine Oil Recommendation.....	210	Emergency Starting with Jumper Cables	267
Cooling System	120	Brake Fluid Level.....	212	Bulb chart.....	269
Porsche Doppelkupplung (PDK).....	121	Fuel Economy	214	Lights, Replacing Bulbs.....	269
Fuel	122	Operating your Porsche in other Countries... 214		Headlights	270
Clock	123	Fuel Recommendations	216	Number Plate Light.....	277
Outside Temperature	123	Portable Fuel Containers.....	217	Changing Light-Emitting Diodes and	
Engine Oil Pressure.....	124	Fuel Evaporation Control.....	217	Long-Life Bulbs	277
Check Engine (Emission Control)	125	Emission Control System	218	Adjusting Headlights	278
On-Board Computer (BC)	126	How Emission Control Works	219	Towing	280
Warnings on the instrument panel		Washer Fluid.....	220		
and the on-board computer.....	158	Power Steering.....	221	Vehicle Identification,	
		Air Filter	222	Technical Data	283
Shifting Gears.....	167	Combination Filter	222	Vehicle Identification	284
Manual Transmission, Clutch.....	168	Fluids/Oils for Manual Transmission		Technical Data	286
Drive-Off Assistant	169	and Porsche Doppelkupplung (PDK).....	222	Diagrams	299
Porsche Doppelkupplung (PDK).....	170	Wiper Blades	223		
		Car Care Instructions.....	224		
Mobile Roofs	177	Practical Tips, Emergency Service ...	233		
Lifting/Sliding Roof	178	Exercise Extreme Caution when Working			
Convertible Top	181	on your Vehicle	234		
Emergency operation of the convertible top.	183	Tires/Wheels	235		
Windstop	190	Loading Information	246		
Hardtop	194	Wheel Bolts	248		
Targa	200	Changing a wheel.....	249		
Roof Transport System.....	204	Flat Tire.....	251		

Dear Porsche Owner

A lot has gone into the manufacture of your Porsche, including advanced engineering, rigid quality control and demanding inspections. These engineering and safety features will be enhanced by you...

the safe driver...

- who knows his/her car and all controls,
- who maintains the vehicle properly,
- who uses driving skills wisely and always drives within her/his own capabilities and the level of familiarity with the vehicle.

You will find helpful hints in this manual on how to perform most of the checks listed on the following pages.

If in doubt, have these checks performed by your authorized Porsche dealer.

Before driving off...

Check the following items first

- f Turn the engine off before you attempt any checks or repairs on the vehicle.
- f Be sure the tires are inflated correctly. Check tires for damage and tire wear.
- f See that wheel bolts are properly tightened and not loose or missing.
- f Check engine oil level, add if necessary. Make it a habit to have engine oil checked with every fuel filling.
- f Check all fluid levels such as windshield washer and brake fluid levels.
- f Be sure the vehicle battery is well charged and cranks the engine properly.
- f Check all doors and lids for proper operation and latch them properly.
- f Check, and if necessary replace worn or cracked wiper blades.
- f See that all windows are clear and unobstructed.
- f Check air intake slots and area between luggage compartment lid and windshield. Ensure that these areas are free of snow and ice, so the heater and the windshield wipers work properly.
- f If a child will be riding in the vehicle, check child seat/child seat restraint system to ensure that restraints are properly adjusted.
- f Child restraint systems will not fit into the Sports bucket seat. Do not install a child restraint system in the Sports bucket seat. The Sports bucket seat cannot be equipped with the LATCH system and thus the airbag system cannot be manually deactivated.
- f Check all exterior and interior lights for operation and that the lenses are clean.
- f Check the headlights for proper aim, and if necessary, have them adjusted.
- f Check under the vehicle for leaks.
- f Be sure all luggage is stowed securely.

Emergency equipment

It is good practice to carry emergency equipment in your vehicle.

Some of the items you should have are: window scraper, snow brush, container or bag of sand or salt, emergency light, small shovel, first-aid kit, etc.

In the driver's seat...

- f Check operation of the horn.
- f Position seat for easy reach of foot pedals and controls.
To reduce the possibility of injury from the airbag deployment, you should always sit back as far from the steering wheel as is practical, while still maintaining full vehicle control.
- f Adjust the inside and outside rear view mirrors.
- f Buckle your safety belts.
- f Check operation of the foot and parking brake.
- f Check all warning and indicator lights with ignition on and engine not running.
- f Start engine and check all warning displays for warning symbols.
- f Never leave an idling car unattended.
- f Lock doors from inside, especially with children in the car to prevent inadvertent opening of doors from inside or outside.
Drive with doors locked.

On the road...

- f Never drive after you have consumed alcohol or drugs.
- f Always have your safety belt fastened.
- f Always drive defensively.
Expect the unexpected.
- f Use signals to indicate turns and lane changes.
- f Turn on headlights at dusk or when the driving conditions warrant it.
- f Always keep a safe distance from the vehicle in front of you, depending on traffic, road and weather conditions.
- f Reduce speed at night and during inclement weather.
Driving in wet weather requires caution and reduced speeds, particularly on roads with standing water, as the handling characteristics of the vehicle may be impaired due to hydroplaning of the tires.
- f Always observe speed limits and obey road signs and traffic laws.
- f When tired, get well off the road, stop and take a rest. Turn the engine off. Do not sit in the vehicle with engine idling.
Please see the chapter "ENGINE EXHAUST" on Page 5.

- f When parked, always set the parking brake. Move the PDK selector lever to "P" or the gear-shift lever to reverse or first gear.
On hills also turn the front wheels toward the curb.
- f When emergency repairs become necessary, move the vehicle well off the road. Turn on the emergency flasher and use other warning devices to alert other motorists. Do not park or operate the vehicle in areas where the hot exhaust system may come in contact with dry grass, brush, fuel spill or other flammable material.
- f Make it a habit to have the engine oil checked with every refueling.

Break in hints for the first 2,000 miles/3,000 kilometers

The following tips will be helpful in obtaining optimum performance from your new Porsche.

Despite the most modern, high-precision manufacturing methods, the moving parts must still wear in with each other. This wearing-in occurs mainly in the first 2,000 miles/3,000 kilometers.

Therefore:

- f Preferably take longer trips.
- f Avoid frequent cold starts with short-distance driving whenever possible.
- f Avoid full throttle starts and abrupt stops.
- f Do not exceed maximum engine speed of 4,200 rpm (revolutions per minute).
- f Do not run a cold engine at high rpm either in Neutral or in gear.
- f Do not let the engine labor, especially when driving uphill. Shift to the next lower gear in time (use the most favorable rpm range).
- f Never lug the engine in high gear at low speeds. This rule applies at all times, not just during the break-in period.

- f Do not participate in motor racing events, sports driving schools, etc. during the first 2,000 miles/3,000 kilometers.

There may be a slight stiffness in the steering, gear-shifting or other controls during the break-in period which will gradually disappear.

Break in brake pads and brake discs

New brake pads and discs have to be "broken in", and therefore only attain optimal friction when the car has covered several hundred miles or km.

The slightly reduced braking ability must be compensated for by pressing the brake pedal harder. This also applies whenever the brake pads and brake discs are replaced.

New tires

New tires do not have maximum traction. They tend to be slippery.

- f Break in new tires by driving at moderate speeds during the first 60 to 120 miles/100 to 200 km. Longer braking distances must be anticipated.

Engine oil and fuel consumption

During the break-in period oil and fuel consumption may be higher than normal.

As always, the rate of oil consumption depends on the quality and viscosity of oil, the speed at which the engine is operated, the climate and road conditions, as well as the amount of dilution and oxidation of the lubricant.

- f Make a habit of checking engine oil with every refueling, add if necessary.

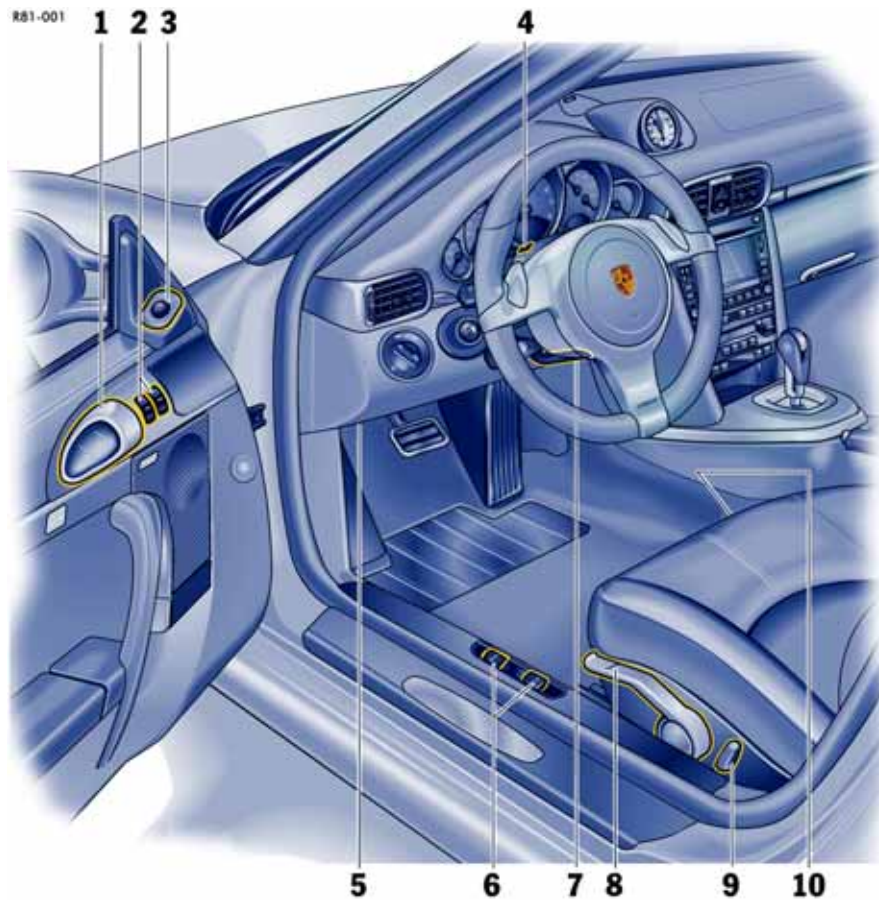

- 1 Inner door handle, Page 18
- 2 Power windows, Page 25
- 3 Door mirror control, Page 27
- 4 Hands-free microphone
- 5 Diagnostic socket (OBD)
- 6 Front and rear lid release, Page 93
- 7 Steering-wheel adjustment, Page 37
- 8 Seat height adjustment, Page 30
- 9 Backrest angle adjustment, Page 30
- 10 Seat fore-and-aft adjustment, Page 30

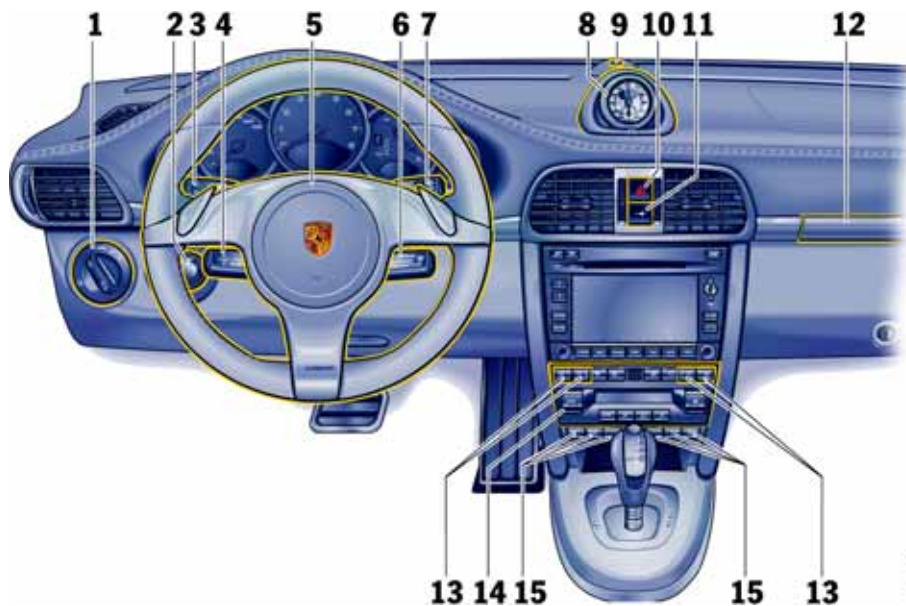

8B3-002

- 1 Light switch, Page 80
- 2 Ignition/starter switch, Page 74
- 3 Turn signal/headlight dimmer, flasher lever, Page 82
- 4 Operating lever for on-board computer, Page 128
- 5 Horn
- 6 Operating lever for automatic speed control, Page 86
- 7 Wiper/washer lever, rear window wiper, Page 83
- 8 Stopwatch, Page 138
- 9 Interior temperature sensor
- 10 Emergency flasher switch, Page 79
- 11 Central locking button, readiness display for alarm system, Page 19
- 12 Cupholder, Page 88
- 13 Seat heating/Seat ventilation left/right, Page 35
- 14 Operating panel for air conditioning, Page 108
- 15 Sport/Sport Plus program, Page 64
 Rear spoiler, Page 69
 Porsche Active Suspension Management (PASM), Page 69
 Porsche Stability Management (PSM), Page 66
 Sports exhaust system, Page 57

12 Before driving off...

Operation, Safety

Keys	15	Porsche Stability Management (PSM).....	66	Fire Extinguisher	102
Security Wheel Bolts	15	Porsche Active Suspension Management		HomeLink.....	103
Doors	18	(PASM).....	69		
Central Locking	19	Retractable Rear Spoiler.....	69		
Alarm System,		Interior Lights	71		
Passenger Compartment Monitoring	23	Parking Aids	72		
Power Windows	25	Ignition/Starter Switch with			
Mirrors.....	27	anti-theft Steering Lock	74		
Rear Window Defogger, Door Mirror Heating ..	29	Starting Procedures	77		
Seat Adjustment and Head Restraints	30	Stopping Engine	78		
Seat Memory.....	33	Emergency Flasher Switch.....	79		
Heated Seats	35	Light Switch	80		
Seat Ventilation.....	36	Welcome Home Lighting.....	81		
Rear Seat Backrests	37	Automatic Headlight Beam Adjustment	81		
Steering Wheel Adjustment	37	Turn Signal / Headlight Dimmer /			
Steering Wheel Heating	38	Parking light / Flasher Lever	82		
Multi-Functional Steering Wheel	39	Windshield Wiper / Washer Lever	83		
Sun Visors.....	40	Automatic Speed Control.....	86		
Safety Belts.....	41	Cupholder	88		
Airbag Systems	44	Ashtray	89		
Child Restraint Systems.....	50	Cigarette Lighter.....	90		
LATCH System		Storage in the Passenger Compartment	91		
Child seat bracket on the passenger's seat	54	Luggage Compartment Lid and			
Child Restraint Anchorages.....	55	Engine Compartment Lid	93		
Rollover Protection System.....	56	Luggage Compartment (Vehicles without			
Sports Exhaust System	57	Porsche Traction Management PTM).....	95		
Parking Brake.....	57	Luggage Compartment (Vehicles with			
Brakes	58	Porsche Traction Management PTM).....	96		
ABS Brake System (Antilock Brake System) ...	61	Trunk Entrapment	97		
Clutch Pedal.....	62	Porsche Communication Management (PCM)..	98		
Porsche Traction Management (PTM).....	63	Car Telephone and Aftermarket Alarms.....	100		
Sport Mode	64	iPod, USB and AUX	101		

Never invite car theft!

An unlocked car with the key in the ignition lock invites car theft.

A steering wheel lock and a **gong alarm** are standard equipment in your Porsche.

The gong alarm will sound if you open the driver's door while the key is still in the ignition lock. It is your reminder to pull the key out of the ignition lock and to lock the doors.



Warning!

Any uncontrolled movement of the vehicle may result in property damage, serious personal injury or death.

Never leave your vehicle unattended with the key in the ignition lock, especially if children and/or pets are left unattended in the vehicle. They can operate power windows and other controls. If the engine is left running, they may accidentally engage the shift lever. Serious personal injury or death could result from loss of control of the vehicle.

- f Always remove the ignition key.
- f Always set the parking brake.
- f Lock the doors with the remote control.

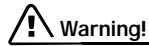

Warning!

Risk of a serious accident.

The steering column will lock when you remove the key while you are driving or as the car is rolling to a stop. You will not be able to steer the car.

Serious personal injury or death could result from loss of control of the vehicle.

- f Never remove the key from the steering lock while you are driving.

To protect your vehicle and your possessions from theft, you should always proceed as follows when leaving your vehicle:

- f Close windows.
- f Close lifting/sliding roof
- f Close convertible top (with the convertible top open, the passenger compartment monitoring system is always switched off)
- f Close the sliding glass roof (Targa) (with the sliding glass roof open, the passenger compartment monitoring system is always switched off)
- f Remove ignition key.
- f Engage steering lock.
- f Lock glove compartment.
- f Remove valuables (e.g. car documents, telephone, house keys) from the car.
- f Lock doors.

Keys

f Please see the chapter "ALARM SYSTEM, PASSENGER COMPARTMENT MONITORING" on Page 23.

f Please see the chapter "CENTRAL LOCKING" on Page 19.

Two car keys are supplied with your Porsche. These keys operate all the locks on your vehicle.

f Be careful with your car keys: do not part with them except under exceptional circumstances.

f To avoid battery run-down, always remove the ignition key from the ignition lock.

Replacement keys

Replacement car keys can be obtained only from your authorized Porsche dealer, and this can sometimes be very time-consuming.

You should therefore always keep a spare key on your person.

Keep it in a safe place (e.g. wallet), but under no circumstances in or on the vehicle.

The key codes of new keys have to be "reported" to the car control unit by your authorized Porsche dealer.

A total of 6 car keys can be reported to the control unit.

Disabling key codes

If a key is lost, the key codes can be disabled by an authorized Porsche dealer.

All the remaining car keys are required for this purpose.

Disabling the code ensures that the car can be **started** only using authorized keys.

Note

f Please note that the other locks can still be opened with the disabled key.

Immobilizer

There is a transponder (an electronic component) in the key grip, containing a stored code.

When the ignition is switched on, the ignition lock checks the code.

The immobilizer can be deactivated and the engine started only using an authorized ignition key.

Switching off the immobilizer

f Insert the ignition key into the ignition lock.

If the ignition is left on for more than 2 minutes without the engine being started, the immobilizer is switched on again.

f If this happens, turn the ignition key back to position **3** (ignition off) before starting the engine. The immobilizer is switched off again, and the engine can be started.

f Please see the chapter "IGNITION/STARTER SWITCH WITH ANTI-THEFT STEERING LOCK" on Page 74.

Switching on the immobilizer

f Remove ignition key.

Security Wheel Bolts

f If wheels have to be removed during a workshop visit, do not forget to hand over the socket for the security wheel bolts along with the car key.



- 1 - Central locking button
- 2 - Luggage compartment lid button
- 3 - Button for glass rear hatch (Targa)
- 4 - Light-emitting diode

Key with Radio Remote Control

Unlocking the vehicle

- f Press button 1.

Locking the vehicle

- f Press button 1.

Switching off the alarm system if it is triggered accidentally

- f Press button 1.

Unlocking luggage compartment lid or glass rear hatch (Targa)

- f Luggage compartment lid: Press button 2 for approx. two seconds.
- f Glass rear hatch (Targa): Press button 3 for approx. two seconds.

If the vehicle was locked, it is unlocked simultaneously with the luggage compartment/glass rear hatch (Targa).

In vehicles with seat memory the stored seat and door mirror positions are automatically set.

The vehicle will be locked again approx. 80 seconds after the luggage compartment/glass rear hatch (Targa) is closed if none of the doors was opened.

Note

Your authorized Porsche dealer can program further types of unlocking for the luggage compartment/glass rear hatch (Targa).

Type 1

The relocking time of the doors can be adjusted to suit your individual requirements:
10 - 100 seconds.

Type 2

The doors stay locked when the luggage compartment/glass rear hatch (Targa) is unlocked.

The remote-control standby function switches off after 7 days

If the vehicle is not started or unlocked with the remote control within 7 days, the remote control standby function is switched off (to prevent discharging of the vehicle battery).

1. In this case, unlock the driver's door with the key at the door lock.
Leave the door closed in order to prevent the alarm system from being triggered.
2. Press button **1** on the remote control.
The remote control is now activated again and the alarm system is switched off.

Operational readiness of the remote control interrupted

Encoded data is transmitted to the vehicle each time the wireless remote control is operated. If the remote control is operated too often outside the range of the vehicle, this can result in the central locking system no longer responding. In this case, the remote control and vehicle must be synchronized.

Carrying out the synchronization

1. Unlock the driver's door with the key at the door lock.
2. Open driver's door and insert the ignition key into the ignition lock within 10 seconds to prevent the alarm system from being triggered.
3. With the key inserted, press and hold button **1** on the remote control for approx. 5 seconds.
The synchronization is now complete.



881-005

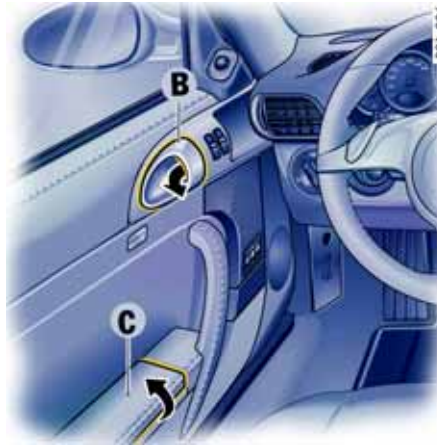

881-006

Doors

If the door windows are closed, they will be automatically opened by a few millimeters when the doors are opened and, when the doors are closed, they will be closed again. This makes it easier to open and close the doors and protects the seals.

- f Therefore, you should pull the door handle slowly so that the door window can be lowered before the door is opened.

Opening doors from outside

- f Unlock vehicle with the remote control.
- f Slowly pull door handle **A**.

Opening unlocked doors from inside

- f Slowly pull door handle **B**.

Opening locked doors from inside

- f Slowly pull door handle **B** twice.
- f Please see the chapter "LOCKING CONDITIONS" on Page 20.

Door storage tray

Opening storage tray

- f Open the cover **C**.

Keep the door storage tray **C** closed while driving for safety reasons.

Central Locking

This device complies with:
Part 15 of the FCC Rules
RSS-210 of Industry Canada.

Operation is subject to the following two conditions:

1. This device may not cause harmful interference, and
2. this device must accept any interference received, including interference that may cause undesired operation.

Note

The manufacturer is not responsible for any radio or TV interference caused by unauthorized modifications to this equipment.
Such modification could void the user's authority to operate the equipment.



Any changes or modifications not expressly approved by Porsche could void the user's authority to operate this equipment.

- f Please see the chapter "LOAD SWITCH-OFF AFTER 2 HOURS OR 7 DAYS" on Page 258.
- f Please see the chapter "SEAT MEMORY" on Page 33.

Both car doors and the filler flap can be centrally unlocked or locked with the remote control.

The vehicle cannot be locked if the driver's door is not completely closed.

A short **signal from the alarm horn** will draw your attention to the fact that the following components are not completely closed when you try to lock the vehicle:

- Driver's door (the vehicle cannot be locked if the driver's door is not completely closed).
- Passenger's door
- Luggage compartment lid
- Engine compartment lid
- Glass rear hatch (Targa)
- Glove compartment

Unlocking the vehicle by using the key in the door lock and opening the door may activate the alarm system within 10 seconds.

Note

- f On vehicles with the Sport Chrono Package Plus, the PCM can be used to activate automatic door locking.
Please observe the chapter "Individual Memory" in the separate PCM operating instructions.

Automatic relocking

If the car is unlocked by remote control and none of the car doors is opened within approx. 100 seconds, automatic relocking takes place.

This relocking time can be adapted to your individual requirements (10 - 100 seconds) by an authorized Porsche dealer.

Locking conditions

- f Lock car **once**.
The doors cannot be opened from the outside. Alarm system and passenger compartment monitoring are switched on.

If a person or animal remains in the vehicle:

- f Quickly lock car **twice**.
The doors cannot be opened from the outside. The passenger compartment monitoring is switched off.

Unlocking the door with the inner door handle

Any person remaining in the locked car can open the door with the inner door handle:

1. Pull inner door handle once to unlock door lock.
2. Pull inner door handle again to open door.

Note

- f Inform any person remaining in the car that the alarm system will be triggered if the door is opened.

Malfunction of the remote control

The remote control may not function correctly due to local radio wave interference. The vehicle will then not lock properly. This can be identified by the missing locking sound and the missing check-back signal of the emergency flasher.

If this should occur:

- f Lock the vehicle with the key in the door.

Emergency operation – opening

- f Unlock the driver's door with the key at the door lock.
Open door within 20 seconds and insert the ignition key into the ignition lock within 10 seconds to prevent the alarm system from being triggered.

Note on operation

If the door is not opened within approx. 20 seconds, automatic relocking takes place. The alarm system will be triggered by the next unlocking of the door:

- f Insert the ignition key into the ignition lock to switch off the alarm system.

Emergency operation – closing

- f Lock the driver's door with the key at the door lock.
If there is a defect in the central locking system, all functioning elements of the central locking system will be locked. The alarm system is switched on. The passenger compartment monitoring system is switched off.

The fault should be remedied immediately at an authorized Porsche dealer.

Indication by emergency flasher and alarm horn

If the **remote control** is used for unlocking or locking, a response is provided by the emergency flasher:

- Unlocking – single flash.
- Locking – double flash.
- Locking twice – continuous illumination for approx. 2 seconds.
The passenger compartment monitoring is switched off.

Fault indication

A double **horn signal** during locking indicates a defect in the central locking or alarm system. Have the defect remedied at an authorized Porsche dealer.

Overload protection

If the central locking system is operated more than ten times within a minute, further operation is blocked for 30 seconds.



Central locking button

The central locking button on the dashboard lets you lock and unlock both doors electrically.

Note

If the doors are locked with the key or remote control, they can not be opened by pressing the central locking button.

Locking

- f Press the central locking button.
Indicator light in the button lights up if ignition is on.

Unlocking

- f Press the central locking button.
Indicator light goes out.

If the doors were locked with the central locking button, they can be opened by pulling the inner door handle:

1. Pull inner door handle once to unlock door lock.
2. Pull inner door handle again to open door.

Automatic door locking

Your authorized Porsche dealer can program diverse types of automatic door locking in the control unit of the central locking system:

Type 1

Doors lock automatically when the ignition is switched on.

Type 2

Doors lock automatically when a speed of 3 - 6 mph (5 - 10 km/h) is exceeded.

Type 3

Doors lock automatically when the ignition is switched on. If doors are opened with the engine running, they lock again automatically when a speed of 3 - 6 mph (5 - 10 km/h) is exceeded.

Type 4

The doors do not lock automatically.

Note

Automatically locked doors can be unlocked with the central locking button or opened by pulling on the inside door handle twice.

- f On vehicles with the Sport Chrono Package Plus, the PCM can be used to activate automatic door locking.
Please observe the chapter "Individual Memory" in the separate PCM operating instructions.

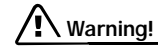

In an emergency situation where you need to exit the car through an automatically locked door, remember the following procedure to open the door.

- f Unlock the doors by pressing the central locking button **or**
 - f pull the inside door handle **twice** to open the door.
-



A - Light-emitting diode for alarm system

Alarm System, Passenger Compartment Monitoring

This device complies with:
Part 15 of the FCC Rules
RSS-210 of Industry Canada.

Operation is subject to the following two conditions:

1. This device may not cause harmful interference, and

2. this device must accept any interference received, including interference that may cause undesired operation.

Note

The manufacturer is not responsible for any radio or TV interference caused by unauthorized modifications to this equipment. Such modification could void the user's authority to operate the equipment.



Warning!

Any changes or modifications not expressly approved by Porsche could void the user's authority to operate this equipment.

The alarm system and passenger compartment monitoring system are switched on when the doors are locked with the key or remote control.

- f Please see the chapter "CENTRAL LOCKING" on Page 19.

Unlocking the vehicle by using the key in the door lock and opening the door may activate the alarm system within 10 seconds.

Switching off the alarm system if it is triggered accidentally

- f Unlock the vehicle with the remote control.

The alarm system and passenger compartment monitoring system are switched off automatically when the doors are unlocked.

Cabriolet, Targa

The passenger compartment monitoring system is always switched off when the convertible top or sliding glass roof (Targa) is open.

Function indication

If the alarm system is activated, light-emitting diode **A** in the central locking switch flashes.

If, after locking, the light-emitting diode does not flash or, after ten seconds, it emits double flashes, then **not** all alarm contacts are closed. Additionally, a brief horn signal sounds.

When the doors are unlocked, the alarm system and passenger compartment monitoring system are switched off and the light-emitting diode goes off.

When the alarm is armed, the following areas are monitored

- Doors
- Luggage compartment lid
- Engine compartment lid
- Convertible-top lock (Cabriolet)
- Glass rear hatch (Targa)
- Glove compartment
- Passenger compartment

If one of these alarm contacts is interrupted, the alarm horn sounds for approximately 3 minutes. Additionally, the emergency flasher flashes and the passenger compartment light lightes for approximately five minutes.

When the alarm is triggered, the light-emitting diode changes over to double flashes.

In order not to limit the action range of the passenger compartment monitoring system:

- f Do not fold the front seat backrests forward.

Deactivating the passenger compartment monitoring system for one locking process

If a person or animal remains in the car while it is locked, the passenger compartment monitoring system must be switched off.

- f Quickly lock car **twice**.
The doors are locked but can be opened from the inside:

1. Pull inner door handle once to unlock door lock.
2. Pull inner door handle again to open door.

Note

- f Inform any person remaining in the car that the alarm system will be triggered if the door is opened.

Fault indication

A double **horn signal** during locking indicates a defect in the central locking or alarm system.

- f Have the defect remedied at an authorized Porsche dealer.



A - Power window in driver's door
 B - Power window in passenger's door
 C - Cabriolet: Switching button for front/rear power windows

Power Windows

Warning!

Risk of injury when the door windows close. This applies especially if the windows are closed with the one-touch operation, because with this function the window goes up automatically.

- f Make sure that fingers, hands, arms or other parts are not in the way when the windows are closed.
- f Remove the ignition key to shut off power to the window switches when the vehicle is not attended by a responsible person. Uninformed persons could injure themselves by operating the power windows.
- f In case of danger, release the button on the car key immediately.
- f Do not leave children in the car unattended.

Risk of an accident.

- f Do not put anything on or near the windows that may interfere with the driver's vision.

Readiness for operation of power windows

- When the ignition is switched on (engine switched on or off) **or**
- with doors closed and ignition key withdrawn, but only until door is first opened. One-touch operation for closing the door windows is available only when the ignition is switched on.

Cabriolet

When the convertible top is open, the rear side windows can only be closed if the door windows are closed.

Opening/closing windows

- f For the **Cabriolet**, select front or rear power windows with rocker switch **C**. The selection is displayed by the respective light-emitting diode.

The two rocker switches **A** and **B** in the driver's door and the switch in the passenger's door have a two-stage function:

Opening

- f Press the rocker switch down to the first stage until the window has reached the desired position.

Closing

- f Press the rocker switch upwards to the first stage until the window has reached the desired position.

One-touch operation

- f Press the rocker switch upwards or downwards to the second stage. Window moves to its final position. Press again to stop the window in the desired position.

Coupé, Targa

One-touch operation for closing the passenger's window is available once the window is approximately half-way closed.

Anti-crushing protection

If a side window is blocked during closing, it will stop and open again by about an inch.

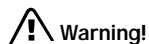

Risk of serious personal injuries.

If the rocker switch is pressed again within 10 seconds of the window being blocked, the window will close with its full closing force. Anti-crushing protection is disabled.

- f Once the anti-crushing protection acts to stop the window and opens it slightly, do not press the rocker switch again within 10 seconds without checking to make sure that nothing is blocking the path of the window. The window will close with full closing force.

One-touch operation is disabled for 10 seconds after blockage of a side window.

Automatic window lowering

- f Please see the chapter "DOORS" on Page 18.
- f Please see the chapter "CONVERTIBLE TOP" on Page 181.

Storing end position of the windows

If the battery is disconnected and reconnected, the windows will not be raised automatically when the door is closed.

1. Close the windows with the rocker switch **once**.
2. Press the rocker switch upwards again to store the end position of the windows in the control unit.



Mirrors

Inside mirror

When the mirror is being adjusted, the anti-glare lever **A** must point forward.

Basic position: lever forward

Anti-glare position: lever back



Door mirrors

Before driving the vehicle, adjust the outside and inside mirrors.

It is important for safe driving that you have clear, unobstructed vision to the rear.

Warning!

Risk of an accident, resulting in serious personal injury or death.

- f Do not put anything on or near the windows or the mirrors that may interfere with the driver's vision.

Risk of damage to the door mirrors when washing the vehicle in a car wash.

- f Fold in door mirrors before using the car wash.

Adjusting door mirrors

1. Switch on ignition.
2. By turning the control switch **A**, select the driver's side or the passenger's side.
3. Move the door mirror glasses in the appropriate direction by tilting the control switch.

If the electrical adjustment facility fails

- f Adjust mirror by pressing on the mirror face.

Automatically swivelling down mirror on the passenger's side

- f Please see the chapter "PARKING AIDS" on Page 72.
- f Please see the chapter "SEAT MEMORY" on Page 33.

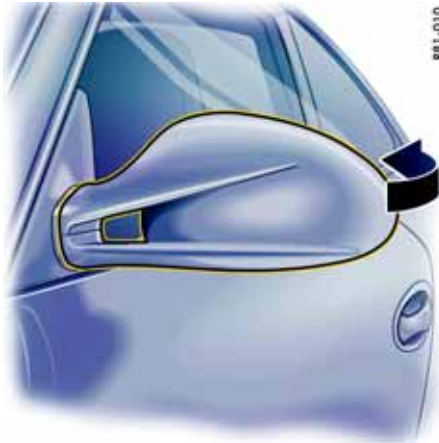

RB1-010



RB1-011

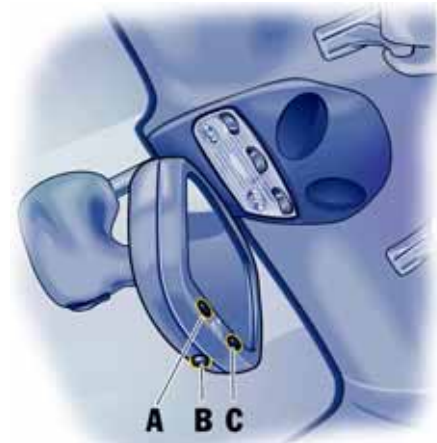

RB1-012

Folding in door mirrors



Warning!

Danger of injury to fingers if the mirror accidentally flips back when being folded in.

- f Exercise extreme caution when folding in mirror by hand. Do not let go of the mirror before the locking lever is locked or the mirror is fully unfolded.

1. Push mirror towards the door window and continue to hold it (high spring force).
2. Swivel the locking lever up to the stop and slowly let go of the mirror.

Unfolding door mirrors

1. Push mirror towards the door window and continue to hold it (high spring force). The locking lever disengages automatically.
2. Move mirror back to unfolded position by hand. Do not let go of the mirror beforehand.

- A - Sensor
- B - Switch for automatic anti-glare operation
- C - Light-emitting diode

Automatic Anti-Glare Interior Mirror and Door Mirror

Sensors on the front and rear sides of the interior mirror measure the incident light. The mirrors automatically change to anti-glare position or revert to their normal state, depending on the light intensity. When reverse gear is selected, automatic anti-glare operation is switched off.

Note

The incident light in the area of the sensors must not be restricted, e.g. by stickers on the windshield.

Switching off the automatic anti-glare operation

- f Press switch **B**.
Light-emitting diode **C** goes out.

Switching on the automatic anti-glare operation

- f Press switch **B**.
Light-emitting diode **C** lights up.

Warning!

Risk of injury. Electrolyte fluid can emerge from a broken mirror glass.
This fluid irritates the skin and eyes.

- f If the electrolyte fluid should come into contact with the eyes or skin, immediately rinse it off with clean water.
See a doctor if necessary.

Risk of damage to the paintwork, leather and plastic parts. Electrolyte fluid can be removed only while it is still wet.

- f Clean the affected parts with water.



Rear Window Defogger, Door Mirror Heating

The mirror heater is ready for operation when the ignition is on.

Switching on

- f Press button.
The light-emitting diode in the button lights up.

After approx. 15 minutes, the heater switches off automatically.
The heater can be switched back on by pressing the button again.

Switching off

- f Press button.
The light-emitting diode in the button goes out.

Seat Adjustment and Head Restraints

Warning!

The seat may move unexpectedly if you attempt to adjust while driving. This could cause sudden loss of control, resulting in serious personal injury or death.

- f Do not adjust seats while the vehicle is in motion.
The backrest locks must be engaged at all times while the vehicle is in motion.

Safety belts only offer protection when the backrest is upright and the belts are properly positioned on the body.

Improperly positioned safety belts or safety belts worn by passengers in an excessively reclined position can cause serious personal injury or death in an accident.

- f Do not operate the car with the driver or passenger backrests excessively reclined (see "Seat position").

Risk of injury if persons or animals are in the movement range of the seat during seat adjustment.

- f Adjust the seat so that no-one is put at risk.

Caution!

Risk of damage to windshield, sun visor, windstop, etc. when the seat is adjusted or folded back or forward.

- f Adjust the seat so that the seat backrest is not in contact with any other object.

The driver and front passenger seats provide integrated head restraints in the backrests. The head restraints are not adjustable. The rear seats do not provide head restraints.

Warning!

All occupants, including the driver, should not operate a vehicle or sit in a vehicle's seat until the head restraints and backrests, respectively, are placed in their proper positions so that the risk of neck injuries is minimized in the event of a crash.

For proper positioning of the head restraint, the seatback's inclination should be adjusted such that the head restraint is in an upright position. Driver and passengers should be seated upright and in the center of their seats.

Seat position

An ergonomically correct sitting position is important for safe and fatigue-free driving. We recommend the following procedure for adjusting the driver's seat to suit individual requirements:

1. Vehicles with manual transmission:

Adjust the seat until, with the clutch pedal fully depressed, your leg remains at a slight angle.

Vehicles with Porsche Doppelkupplung (PDK):

Adjust the seat until, with your left foot on the footrest, your left leg remains at a slight angle.

2. Rest your outstretched arm on the steering wheel.

Set the backrest angle (not applicable for Sports bucket seat) and the steering-wheel position so that your wrist rests on the outer rim of the steering wheel. At the same time, the shoulders must still be in noticeable contact with the backrest.

3. Adjust the seat height (not applicable for Sports bucket seat) to give yourself enough headroom and a good overview of the vehicle.

4. Electrically adjustable seat:

Adjust the seat angle until your thighs rest lightly on the seat cushion.

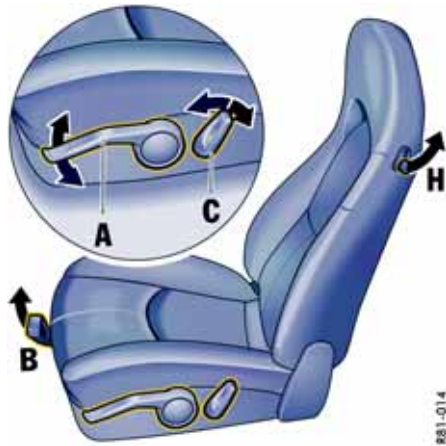

Standard seat/sports seat

A Seat height

- f Use lever **A** in a pumping movement:
Upwards – seat moves upwards
Downwards – seat moves downwards

B Fore and aft

- f Raise locking lever **B**.
Move seat to desired position and release lever.
Ensure that the seat engages correctly.

C Backrest angle

- f Operate switch **C** until the desired backrest angle is reached.

Seat backrest

Folding forward

- f Pull up lever **H** in the side part of the backrest and fold the backrest forward.

Folding back

- f Tilt back and engage the backrest so that it cannot tip forward when the car is braked.

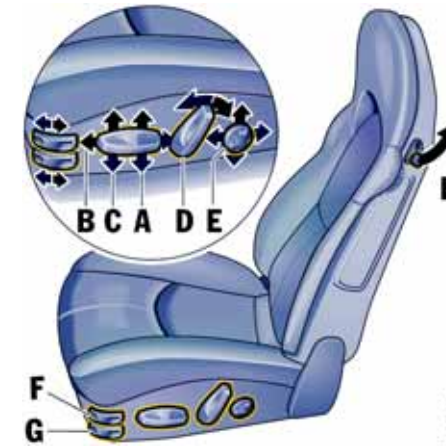

Comfort seat with driver seat memory/ Adaptive sports seat with driver seat memory

- f Press the switch in the direction indicated by the arrow until the desired setting is reached.

A Seat height adjustment

B Fore-and-aft position adjustment

C Seat angle adjustment

D Backrest angle adjustment

E Lumbar support (pelvis and spinal column support)

To permit a relaxed sitting posture, the backrest curvature is continuously adjustable in vertical and horizontal directions for individual pelvis and spinal column support.

- f Press the switch in the direction indicated by the arrow until the desired backrest curvature is reached.

F Adjusting the backrest side bolsters (adaptive sports seat only)

- f Push forward or pull backward switch **F** until the side bolsters are adjusted to the shape of the body.

G Adjusting the seat cushion side bolsters (adaptive sports seat only)

- f Push forward or pull backward switch **G** until the side bolsters are adjusted to the shape of the body.

Seat backrest

Folding forward

- f Pull up lever **H** in the side part of the backrest and fold the backrest forward.

Folding back

- f Tilt back and engage the backrest so that it cannot tip forward when the car is braked.



Sports bucket seat

⚠ Do not install a child restraint system in the Sports bucket seat. The Sports bucket seat cannot be equipped with the LATCH system.

A Fore and aft adjustment

- f Raise locking lever **A**. Move seat to desired position and release lever. Ensure that the seat engages correctly.

B Backrest

Folding forward

- f Pull loop **B** in the side part of the backrest and fold the backrest forward.

Folding back

- f Tilt back and engage the backrest so that it cannot tip forward when the car is braked.



M - Memory button
1 - Key button
2, 3 - Person buttons

Seat Memory

Individual seat and door mirror settings can be stored and recalled for the driver's position. You cannot store the position of the side bolsters of the adaptive sports seat.

Further individual setting options are available in vehicles with the Sport Chrono Package Plus.

- f Please observe the chapter "Individual Memory" in the separate PCM operating instructions.

Warning!

Risk of crushing due to uncontrolled recall of a seat setting.

- f Cancel automatic adjustment by pressing any of the seat adjustment buttons.
- f Do not leave children in the vehicle unattended.

Operation with person buttons 2, 3

Storing seat position

1. Switch on ignition.
Reverse gear must not be engaged.
2. Set the desired seat and door-mirror positions.
3. Keep memory button **M** depressed and also press person button **2** or **3** until an audible signal confirms that the position has been stored.
The individual setting is now stored under the desired person button.

Recalling seat position

The seat position can only be called up when the vehicle is stationary.

1. Switch on the ignition **or** open the driver's door.
2. Press person button until the seat has reached its final position.
The setting of door mirrors and lumbar support will be completed even if the person button is not kept depressed.

Note

Automatic seat adjustment can be interrupted immediately by releasing the button.

Operating with the remote control of the vehicle key

Each remote control (up to six) can be assigned an individual seat and door mirror position. The stored seat and door mirror position is set automatically when the vehicle is unlocked using the corresponding remote control.

Storing seat position

1. Switch the ignition on with the desired car key. Reverse gear must not be engaged.
2. Set the desired seat and door-mirror positions.
3. Keep memory button **M** depressed and also press key button **1** until an audible signal confirms that the position has been stored. The individual setting is now assigned to this remote control and to the key button. It is necessary to wait for at least 15 seconds between locking and unlocking the door.

Storing individual lowered position of the passenger's door mirror as a parking aid

Once the driver's seat setting has been stored, an individual lowered position of the passenger's door mirror may be stored for driving in reverse:

1. Apply the handbrake.
2. Switch the ignition on with the desired car key.
3. Engage reverse gear.
4. Select passenger side with mirror switch. The passenger's mirror swivels downwards.
5. Set passenger's door mirror to desired final position.
6. Keep memory button **M** depressed and also press key button **1** until an audible signal confirms that the position has been stored. The individual setting is now assigned to this remote control and to the key button.

Recalling seat position

- f Unlock the locked vehicle or the luggage compartment with the remote control. The stored seat position is automatically set.

The seat position assigned to a remote control can also be recalled with the key button **1** if the corresponding key was used to switch on the ignition.

If no seat position has been assigned to a remote control, the key button will not work.

Note on operation

Automatic seat adjustment can be interrupted immediately:

- f by switching on the ignition,
- f by pressing the central locking button,
- f by pressing any memory or seat adjustment button.

Clearing the stored seat position

1. Switch the ignition on with the desired car key.
2. Press memory button twice and key button **1** once consecutively.



A - Seat heating, left
B - Seat heating, right

Heated Seats

Two-stage seat heating is ready for operation when the engine is running.

The yellow light-emitting diodes in the button show which stage is currently activated.

Switching on

High heating power

- Press button once.
Both light-emitting diodes in the button light up.

Low heating power

- Press button twice.
One light-emitting diode in the button lights up.

Switching off

- Press button as often as necessary until the light-emitting diodes go out.

Seat Ventilation

The three-stage seat ventilation is ready for operation when the engine is running and from an ambient cabin temperature of 58 °F (15 °C).

The three stages are controlled with the buttons on the control panel for the air conditioning.

The blue light-emitting diodes in the buttons show which stage is currently activated.

Note

The full effect of the seat ventilation can be achieved only if you are wearing breathable clothing.

Seat ventilation and seat heating can be used at the same time and provide excellent seating comfort when used in the right combination.

- f Do not use protective seat covers.



A - Seat ventilation, left
B - Seat ventilation, right

Switching off seat ventilation

- f Press button as often as necessary until all light-emitting diodes go out.

Switching on seat ventilation

High ventilation

- f Press button **once**.
Three light-emitting diodes light up.

Medium ventilation

- f Press button **twice**.
Two light-emitting diodes light up.

Low ventilation

- f Press button **three times**.
One light-emitting diode lights up.

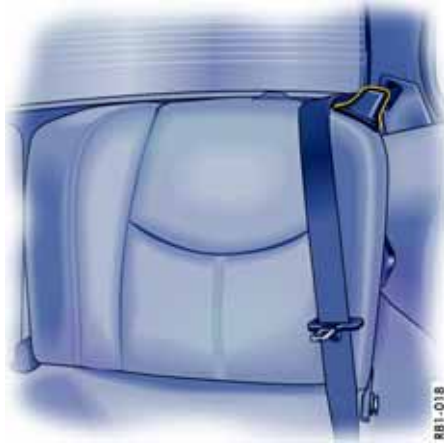

Rear Seat Backrests

Extra storage space is gained by folding the rear seat backrests forward.

Folding forward

- f Pull lever forward and fold the backrest forward.

Folding back

- f Tilt the backrest back until you feel it click into place. When doing so, make sure that the seat belt is properly routed (see figure).

Cabriolet

- f Do not fold up the rear seat backrests with the windstop installed.

Steering Wheel Adjustment

Warning!

Risk of accident.

The steering wheel may move further than desired if you attempt to adjust it when driving.

You can lose control of the vehicle, causing serious personal injury or death.

- f Do not adjust the steering wheel when driving.

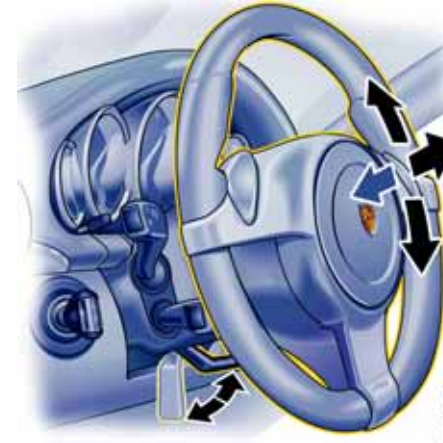

Adjusting steering wheel height and longitudinal direction

1. Insert ignition key fully into ignition lock.
2. Push the locking lever downwards.
3. Adjust steering wheel to fit the chosen backrest angle and your seat position by moving the steering wheel up or down and longitudinally.
4. Swivel locking lever back until you feel it engage.
If necessary, move steering wheel slightly longitudinally.



Switching on steering wheel heating

- f Press button.
The message "Steering wheel heating ON" is displayed on the on-board computer for 2 seconds.

Switching off steering wheel heating

- f Press button.
The message "Steering wheel heating OFF" is displayed on the on-board computer for 2 seconds.

Steering Wheel Heating

The steering wheel heating can be switched on and off with the button on the rear of the steering wheel when the ignition is switched on.

Multi-Functional Steering Wheel



Warning!

There is a danger of accident if you set or operate the on-board computer, radio, navigation system, telephone or other equipment when driving.

Operating these devices while driving could distract you from traffic and cause you to lose control of the vehicle.

- f Operate these components while driving only if the traffic situation allows you to do so safely.
- f Carry out any complicated operating or setting procedures only while the vehicle is stationary.

Depending on the equipment in your vehicle, you can use the function keys of the multi-functional steering wheel to operate the following Porsche communication systems:

- PCM
- Telephone
- CD-Audio, DVD-Audio



Readiness for operation of multi-functional steering wheel

The multi-functional steering wheel is ready for operation when the ignition **and** PCM are switched on.

Operating the function keys

- f Please read the separate PCM operating instructions before operating the function keys.

The rotary knobs at the top left and right of the steering wheel can also be pressed.



Turn volume control

Upwards – increase volume.

Downwards – decrease volume.

Press volume control

To switch volume/mute on and off.



Turn rotary knob

To select/mark function in the PCM within a menu. To do this, turn the rotary knob upward or downward.

Press rotary knob

To activate selected function.



Press screen button

To call the stored PCM function.

The button can be assigned the desired function in the PCM.



Press Back button

To move back in the PCM menu.



Press Handset Pickup button

To accept a telephone call.



Press Handset Hangup button

To end or refuse a telephone call.

Sun Visors

- f Swing the sun visors down to prevent glare from the front.
- f To prevent glare from the side, unclip the sun visor from the inner bracket and swivel round so that it is in front of the door window.

Vanity mirror

The vanity mirror on the rear of the sun visor is covered by a lid.

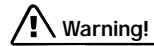

Warning!

Risk of injury in an accident or risk of damage to mirror lid and convertible top.

- f Keep the lid closed while driving and when closing the convertible top.

Risk of damage.

- f Do not force the lid beyond its end position.



Coupé, Cabriolet

The vanity mirror illumination is switched on automatically when the cover is opened (**arrow**).



Targa

The vanity mirror illumination is switched on automatically when the sliding cover is opened (**arrow**). The light is switched off when the sun visor is in its upper or lower end position.

Safety Belts

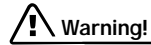

Warning!

Always make sure your and your passengers' safety belts are properly fastened while the vehicle is in motion.

Failure to follow safety belt warnings may result in serious personal injury or death.

- f For your and your passengers' protection, use safety belts at all times while the vehicle is in motion.
- f Use appropriate child restraint systems for all small children.

Proper wearing of safety belts

- f Safety belts must be positioned on the body as to restrain the upper body and lap from sliding forward. Improperly positioned safety belts can cause serious personal injury or death in case of an accident.
- f The shoulder belt should always rest on your upper body. The shoulder belt should never be worn behind your back or under your arm.
- f For maximum effectiveness, the lap belt should be worn low across the hips.
- f Pregnant women should position the belt as low as possible across the pelvis. Make sure it is not pressing against the abdomen.

- f Belts should not be worn twisted.
- f Do not wear belts over rigid or breakable objects in or on your clothing, such as eye glasses, pens, keys, etc. as these may cause injury.
- f Several layers of heavy clothing may interfere with proper positioning of belts.
- f Belts must not rub against sharp objects or damage may occur to the belt.
- f Two occupants should never share the same belt at the same time.

Care and maintenance

- f Keep belt buckles free of any obstruction that may prevent a secure locking.
- f Belts that have been subjected to excessive stretch forces in an accident must be inspected or replaced to ensure their continued effectiveness in restraining you. The same applies to belt tensioner systems which have been triggered. In addition, the anchor points of the belts should be checked.
- f If safety belts do not work properly, see your authorized Porsche dealer immediately.
- f If the belts show damage to webbing, bindings, buckles or retractors, they should be replaced to ensure safe operation.
- f Do not modify or disassemble the safety belts in your vehicle.

- f The belts must be kept clean or the retractors may not work properly. Please see the chapter "CAR CARE INSTRUCTIONS" on Page 224.
- f Never bleach or dye safety belts.
- f Do not allow safety belts to retract until they are completely dry after cleaning or this may cause damage to the belt.

Belt tensioner

Depending on the force of an impact, fastened front seat safety belts are tightened in an accident.

The belt tensioners are triggered in:

- Front, side and rear impacts of sufficient severity.
- For the Cabriolet, in cases of vehicle rollover.

Note

The belt-tensioner system can be triggered only once; the system must be replaced afterward.

If there is a fault in the belt-tensioner system, the airbag warning light lights up.

Work may be performed on the belt-tensioner system only by an authorized Porsche dealer. Smoke is released when the belt tensioners are triggered. This does not indicate a fire in the vehicle.



Safety Belt Warning System

An **audio-visual warning** system is interconnected with the driver's safety belt.

Every time the ignition is turned on, the gong will sound for about 6 seconds to remind driver and passenger to buckle up.

In addition, the gong will sound for approx. 90 seconds if vehicle speed exceeds 15 mph/24 km/h. The safety belt warning lights in the instrument panel and on-board computer will go off as soon as the driver has buckled up.



Inertia reel retractor

The combination lap/shoulder belt with inertia reel locking mechanism adjusts automatically to your size and movements as long as the pull on the belt is slow.

Rapid deceleration during hard braking or a collision locks the belt. The belt will also lock when you drive up or down a steep hill or in a sharp curve, otherwise, the shoulder belt will not inhibit your upper body movement.

Fastening the safety belt

- f Assume a comfortable sitting position.
- f Please see the chapter "SEAT POSITION" on Page 30.
- f The shoulder belt should always rest on your upper body. The shoulder belt should never be worn behind your back or under your arm.
- f Grasp belt and pull the belt in a continuous slow motion across your chest and lap.
- f Insert belt tongue into buckle on inboard side of seat. Push down until it securely locks with an audible click. Pull the belt to check.
- f Pull shoulder section to make sure belt fits snugly across the pelvis.
- f Belts should fit snugly across the pelvis and chest. Make sure there is no slack in the belt.

Releasing the safety belt

- f Push in release button (**arrow**) on buckle. Belt tongue will spring out of buckle.
- f To release a latched belt, lean back to take the body pressure off the belt.
- f To store lap/shoulder belt, allow the belt to retract as you guide the latch to its stowed position.
- f Please see the chapter "AUTOMATIC LOCKING RETRACTOR" on Page 53.



Cleaning the safety belts

If it becomes necessary to clean the belts, you can use any mild washing agent. Allow the belts to dry prior to retracting, but avoid direct sunlight.

- f Only use suitable cleaners. If unsuitable cleaners are used or any attempt is made to dye or bleach the belts, the webbing may be weakened and thus constitute a safety risk.

Safety belt height adjustment

(Coupé and Targa)

The height of the belt deflectors for the driver's seat and passenger's seat can be adjusted.

Adjust the height of the safety belt so that it runs across the middle of the shoulder, not against the neck.

Adjusting belt height

- f Upward – push belt deflector up.
- f Downward – press button (**arrow**) and move belt deflector.

Airbag Systems

The airbags in combination with the safety belts make up a safety system which offers the driver and the passenger the greatest known protection from injuries in case of accident.

Your vehicle is equipped with a weight sensing system for the front passenger's seat in accordance with U.S. Federal Motor Vehicle Safety Standard 208.

Even if your vehicle is equipped with airbags, **the safety belts must be worn at all times**, because the front airbag system is only deployed by frontal collisions with an impact of sufficient severity.

Below the deployment threshold of the airbag system, and during types of collisions which do not cause the actuation of the system, the safety belts provide the primary protection to the occupants when correctly worn.

Therefore, all persons within the vehicle must wear safety belts at all times (in many states, state law requires the use of safety belts).

f Please see the chapter "SAFETY BELTS" on Page 41.

The **front airbags** are located under the padded steering wheel panel on the driver's side and, on the passenger's side, in the dashboard.

The **side airbags** for the front seats are installed on the side in the seat backrests.

The **head airbags** are installed in the door linings.



Danger!

To provide optimal occupant protection, airbags must inflate at very high speed. If you are not wearing your safety belt or are too close to the airbag when it is deployed, inflating airbags can result in serious personal injury or death.

- f Make sure there are no people, animals or objects between the driver or passenger and the area into which the airbag inflates.
- f Sit back as far from the dashboard or steering wheel as is practical, while still maintaining full vehicle control.
- f Always hold the steering wheel by the outer rim. Never rest your hands on the airbag panel.
- f **Always fasten seat belts** because triggering of the airbag system depends on the force and angle of impact.
- f Do not transport heavy objects on or in front of the passenger's seat. These could impair the function of the airbag, the seat belts, and weight sensing.
- f Do not hang objects (e.g. jackets, coats, coat hangers) over the backrest.
- f Always keep the lid of the door storage compartment closed. Objects must not protrude out of the door storage compartment.
- f No changes may be made to the wiring or components of the airbag system.
- f Do not add any additional coverings or stickers to the steering wheel or in the area of the passenger's airbag, side airbags and head airbags. Doing so may adversely affect the functioning of the airbag system or cause harm to the occupants if the airbag system should deploy. Do not use protective seat covers.
- f Do not modify the seat coverings. Do not attach additional cushions, protective coverings, or pillows to the passenger's seat. Do not affix things to the passenger's seat or cover it with other materials. Do not cover the back of the backrest. Do not make changes to the passenger's seat and to the seat base frame.
- f Do not undertake any wiring for electrical accessory equipment in the vicinity of the airbag wiring harnesses. Doing so may disable the airbag system or cause inadvertent inflation.
- f If the warning light comes on, the airbag system should be repaired immediately by your authorized Porsche dealer.
- f Always keep feet in the footwell while driving. Do not put feet on the dashboard or the seat area. Do not lean against the inside of the door or outside the window while the vehicle is moving.

- f Using accessories not approved by Porsche can cause the weight sensing system to be impaired.
- f Do not squeeze objects, such as the fire extinguisher, or first aid kit under the seat.
- f Only have seats removed and installed by an authorized Porsche dealer so that weight sensing components will not be damaged.
- f Give your passenger all of the information in this chapter.

Note

Airbag components (e.g. steering wheel, door lining, seats) may be disassembled only by an authorized Porsche dealer.

When disposing of a used airbag unit, our safety instructions must be followed. These instructions can be obtained at any authorized Porsche dealer.

Function of the airbag system

Airbags are a supplemental safety system. Your primary protection comes from your safety belts.

The front airbags are triggered during a frontal collision of sufficient force and direction. In the event of a side impact of corresponding force, the side airbag on the impact side is triggered.

The inflation process generates the amount of gas required to fill the airbags at the necessary pressure in fractions of a second.

Airbags help to protect the head and upper body, while simultaneously damping the motion of the driver and passenger in the impact direction in the event of a frontal impact or side impact.

In order to help provide protection in severe collisions which can cause death and serious injury, airbags must inflate extremely rapidly. Such high speed inflation has a negative but unavoidable side effect, which is that it can and does cause injuries, including facial and arm abrasions, bruising and broken bones. You can help minimize such injuries by always wearing your safety belts.

There are many types of accidents in which airbags are not expected to deploy. These include accidents where the airbags would provide no benefit, such as a rear impact against your vehicle. Other accidents where the airbags are designed not to deploy are those where the risk of injury from the airbag deployment could exceed any protective benefits, such as in low speed accidents or higher speed accidents where the vehicle decelerates over a longer time. Since airbag deployment does not occur in all accidents, this further emphasizes the need for you and your passengers to always wear safety belts.

Your vehicle is equipped with a crash sensing and diagnostic module. This module will record the use of the seat belt restraint system by the driver and front passenger when the airbags and/or belt tensioner work.

Advanced Airbag

Your vehicle is equipped with a weight sensing system for the passenger's seat in accordance with U.S. Federal Motor Vehicle Safety Standard 208. Depending on the weight acting on the front passenger's seat, the front passenger's airbag will automatically be switched on and off.

Depending on the angle and force of impact, the front passenger's airbag which is activated will be triggered during a collision.

Precondition for switching the front passenger's airbag on and off, depending on weight:

- Vehicles equipped with key-operated airbag deactivation device:
Switch position AUTO.
- Ignition key is inserted.

Improper handling of the weight sensing system can unintentionally impair switching the passenger's airbag off and on.

Seat adjustment for the front passenger's seat



Danger!

Safety belts only offer protection when the backrest is upright and the belts are properly positioned on the body. Improperly positioned safety belts can cause serious personal injury or death in an accident.

- f Do not operate the car with the driver or passenger backrests excessively reclined.
- f Porsche recommends the use of L.A.T.C.H. (Lower Anchorage and Tether for Children) equipped Porsche child seat.
**Do not install a child restraint system in the Sports bucket seat.
The Sports bucket seat cannot be equipped with the LATCH system.**

If the seat is in an extreme position (e.g., the backrest is in contact with the rear seat), the backrest can warp. Warping of the backrest can lead to malfunctions.

- f Correct the seat adjustment.
Ensure that the seat is not jammed and is self-supporting.
Ensure that the backrest is in the upright position.
- f Do not transport a load and objects in the rear footwell and under the passenger's seat.
If the load or objects are under the seat, it can cause malfunctions.

If the weight on the passenger's seat is reduced significantly, e.g., by supporting weight on the armrest, the passenger's airbag can be switched off.

- f Select an upright seat position, and do not support weight on the armrests or lean out of the window.
Always keep feet in the footwell while driving. Do not put feet on the dashboard or the seat area. Do not lean against the inside of the door or outside the window while the vehicle is moving.

If the passenger's seat is warped significantly, a message is displayed on the on-board computer:

- f Correct the seat adjustment.
- f Please see the chapter "WARNINGS ON THE INSTRUMENT PANEL AND THE ON-BOARD COMPUTER" on Page 158.

Vehicle modifications to accommodate persons with disabilities

Because modifications to your vehicle could compromise your advanced airbag system, please call 1-800-PORSCHE prior to having your vehicle modified.

Automatic deactivation of the front passenger's airbag.



Danger!

The use of a child restraint system in the front passenger's seat can result in serious personal injury or death to the child from an airbag deployment.

- f Please see the chapter "PASSENGER AIRBAG OFF INDICATOR LAMP DOES NOT LIGHT UP" on Page 47.
- f Before transporting a child on the passenger's seat:
Please see the chapter "CHILD RESTRAINT SYSTEMS" on Page 50.
- f **Do not install a child restraint system in the Sports bucket seat.**
 - When an **up to one-year old child** is seated in the child restraint system, the front airbag is automatically deactivated on the passenger's side.
 - When an adult is seated in the front seat, the front airbag remains active on the passenger's side.



PASSENGER AIRBAG OFF indicator lamp

Note on operation

Although not desired, it can occur in the case of heavier children that the passenger's airbag remains active or, in the case of very light adults or young persons, that the passenger's airbag is deactivated.

The condition of the passenger's front airbag is shown by the indicator lamp.

If in doubt:

- f Please see the chapter "PASSENGER AIRBAG OFF INDICATOR LAMP DOES NOT LIGHT UP" on Page 47.

- f Please see the chapter "KEY-OPERATED AIRBAG DEACTIVATION DEVICE" on Page 49.
- f Please see the chapter "CHILD RESTRAINT SYSTEMS" on Page 50.
- f Please see the chapter "LATCH SYSTEM CHILD SEAT BRACKET ON THE PASSENGER'S SEAT" on Page 54.

Note

- f After inserting the ignition key, the PASSENGER AIRBAG OFF warning light lights up for a few seconds as a bulb check.

PASSENGER AIRBAG OFF indicator lamp lights up

- The passenger's airbag is switched off.

PASSENGER AIRBAG OFF indicator lamp does not light up

- The passenger's airbag is active and ready for operation.
- If the passenger's seat is not occupied, the PASSENGER AIRBAG OFF indicator lamp will also not light up, even though the passenger's airbag is switched off.

! Danger!

Risk of serious personal injury or death due to the passenger airbag triggering unintentionally.

When the ignition key is inserted and the up to one-year old child is seated in the child restraint system on the passenger's seat, the indicator lamp "PASSENGER AIRBAG OFF" must be on.

If the "PASSENGER AIRBAG OFF" indicator lamp does not light up, it could indicate a fault in the system.

In this case:

- f Child restraint systems **facing forwards**:
Install on the rear seats.
- f Child restraint systems **facing rearwards**:
On vehicles **with** key-operated airbag deactivation device: Switch to position OFF.
- f Child restraint systems **facing rearwards**:
On vehicles **without** key-operated airbag deactivation device: Do not use a child restraint system in the front passenger's seat.
- f Have the fault remedied at your nearest authorized Porsche dealer.

Note

The key switch for switching off the passenger's airbag in combination with the LATCH attachment bracket are not installed at the factory. They can be retrofitted.

f Please see your authorized Porsche dealer.



Warning light and warning message

Faults are indicated by a warning light in the instrument panel and a message on the on-board computer.

f Please see the chapter "WARNINGS ON THE INSTRUMENT PANEL AND THE ON-BOARD COMPUTER" on Page 158.

f **In the following cases you should immediately consult an authorized Porsche dealer in order to assure the airbag system is functioning properly:**

- If the warning light does not light up when the ignition key is inserted **or**
- If the warning light does not go out once the engine is running **or**
- If the warning light appears while driving.

Airbag maintenance

In order to ensure long-term functioning, the airbag system must be inspected by an authorized Porsche dealer at the intervals recommended in your Maintenance Booklet.

Important information

If you sell your Porsche, notify the purchaser that the vehicle is equipped with airbags, and refer them to the chapter, "Airbag Systems", in the Owner's Manual (safety and disposal rules).

Further information on the airbag system can be found on stickers attached to the sun visors.

For special recommendations on the use of child restraints:

f Please see the chapter "CHILD RESTRAINT SYSTEMS" on Page 50.



Key-operated airbag deactivation device

In case your vehicle is equipped with LATCH, you can switch off (OFF) the passenger's front airbag manually. In the automatic mode (AUTO), the airbag will be switched on or off automatically depending on the weight on the passenger seat.

- f Switch off the passenger's airbag on the key switch using the vehicle key.

Switch position AUTO – passenger's front airbag is active

Switch position OFF – passenger's front airbag is switched off



PASSENGER AIRBAG OFF indicator lamp

! Danger!

Risk of serious personal injury or death for passenger if passenger's airbag remains switched off after the child restraint system is removed.

- f Make sure that the key switch is switched to AUTO once the child seat has been removed, in order to provide protection to the adult occupants.

Warning light "PASSENGER AIRBAG OFF"

If the airbag on the passenger's side is switched off:

- Warning light "PASSENGER AIRBAG OFF" is continuously lit when the ignition key is inserted.

! Danger!

Risk of serious personal injury or death from the passenger's airbag.

If the "PASSENGER AIRBAG OFF" warning light is not lit when the ignition key is inserted and the Airbag OFF switch is switched to the OFF-Position, this could indicate a fault in the system.

- f Do not install a child restraint system on the passenger's seat.
- f Have the fault remedied immediately. Please see your authorized Porsche dealer.

Note

- f **Do not install a child restraint system in the Sports bucket seat.**

The key switch for switching off the passenger's airbag in combination with the LATCH attachment bracket are not installed at the factory. They can be retrofitted (not on vehicles with Sports bucket seats).

- f Please see your authorized Porsche dealer.

Child Restraint Systems

- f Do not install a child restraint system in the Sports bucket seat.

The Sports bucket seat cannot be equipped with the LATCH system.

Porsche recommends that all infants and children be restrained in child restraint systems at all times while the vehicle is in motion in accordance with applicable laws.

Use only child restraint systems with the LATCH-system recommended by Porsche. These systems have been tested and adjusted to the interior of your Porsche and the appropriate child weight groups. Other systems have not been tested and could entail an increased risk of injury or death.

You can obtain child seats that are LATCH compatible at your authorized Porsche dealer.

- f Always observe the separate installation instructions for your child seat.

The use of infant or child restraints is required by law in all 50 states of the U.S. and all Canadian provinces. The child restraint system should be one that complies with U.S. Federal Motor Vehicle Safety Standards and should be secured by a lap belt or lap belt portion of a lap-shoulder belt or for child seats equipped with the LATCH system (Lower Anchorage and Tether for Children, also known as ISOFIX) to the LATCH anchorages.

A statement by the seat manufacturer of compliance with this standard can be found on the instruction label on the restraint and in the instruc-

tion manual provided with the restraint.



Danger!

The use of a child restraint system in the front passenger's seat can result in serious personal injury or death to the child from an airbag deployment.

To reduce risk of injury from an inflating airbag in an accident, Porsche strongly recommends:

- f Please see the chapter "PASSENGER AIRBAG OFF INDICATOR LAMP DOES NOT LIGHT UP" on Page 47.
- f Please see the chapter "CHILD RESTRAINT SYSTEMS" on Page 50.
- f **Do not install a child restraint system in the Sports bucket seat. The Sports bucket seat cannot be equipped with the LATCH system.**

Note

The key switch for switching off the passenger's airbag and the LATCH attachment bracket are not installed at the factory. They can be retrofitted (not on vehicles with Sports bucket seats).

- f Please see your authorized Porsche dealer.



Danger!

Risk of serious personal injury or death to the child.

- f Follow all child restraint instructions and warnings in this manual.
- When using an infant or child restraint system, be sure to follow all manufacturer's instructions on installation and use.
- Infants and small children should never be held on the lap, nor should they share a safety belt with another occupant while the vehicle is in motion.
- Children too big for child restraint systems should use regular safety belts. A shoulder belt can be used providing it does not cross the face or the neck of the child.
- Choose a child restraint system according to the weight of the child.
- Child restraint systems that are damaged or have been heavily stressed in an accident must be replaced immediately.
- Children could be endangered in a crash if their child restraints are not properly secured in the vehicle.
- Do not affix things to child restraint systems or cover it with other materials.

- Your authorized Porsche dealer will be glad to advise you about the installation possibility for a Porsche child restraint system which allows a key-operated airbag deactivation of the passenger's airbag.
 - The key-operated airbag deactivation device installation requires special programming available only from your authorized Porsche dealer.
- f Please see the chapter "KEY-OPERATED AIRBAG DEACTIVATION DEVICE" on Page 49.

Direction of installation for child restraint systems

According to accident statistics, children are safer when properly restrained in the rear seating positions than in the front seating positions.

Under all normal circumstances, the forward facing child seat must be placed in the rear.

Group 0 and 0+: Children up to 29 lbs (13 kg)

Children of this weight must be transported in a restraint system which is installed on the passenger's seat **facing rearward**.

Group I: Children in between 20 lbs (9 kg) and 40 lbs (18 kg)

Children of this weight are held in child restraint systems **facing forward**. Whenever possible, these child restraint systems should be installed on the rear seats.

Group II: Children in between 33 lbs (15 kg) and 55 lbs (25 kg)

Children of this weight are held in child restraint systems **facing forward**. Whenever possible, these child restraint systems should be installed on the rear seats.

Group III: Children in between 49 lbs (22 kg) and 80 lbs (36 kg)

Children of this weight are held in child restraint systems **facing forward**. Whenever possible, these child restraint systems should be installed on the rear seats.

If a child restraint system must be fastened to the passenger's seat, the passenger's seat must be adjusted to the lower rear position.

Note

If a child seat with top tether is adapted for use on the front seat, the rear right (passenger's side) anchor point must be used for anchoring the top tether.

It is then not permitted for a passenger to use the rear right (passenger's side) seat.

It is then not permitted to install a child restraint system on the rear right (passenger's side) seat.

- f Please see the chapter "CHILD RESTRAINT ANCHORAGES" on Page 55.

Using child restraint systems in the front passenger seat

- f Do not install a child restraint system in the Sports bucket seat.



The use of a child restraint system in the front passenger seat can result in serious personal injury or death to the child from an airbag deployment.

To reduce risk of injury from an inflating airbag in an accident, Porsche strongly recommends:

- f Please see the chapter "PASSENGER AIRBAG OFF INDICATOR LAMP DOES NOT LIGHT UP" on Page 47.
- f Please see the chapter "CHILD RESTRAINT SYSTEMS" on Page 50.
- f **Do not install a child restraint system in the Sports bucket seat. The Sports bucket seat cannot be equipped with the LATCH system.**

Child restraint system for up to one-year old children

- Make sure that the PASSENGER AIRBAG OFF indicator lamp lights up.
- Adjust the passenger's seat as far away from the airbag as possible.



Risk of serious personal injury or death due to the passenger's airbag triggering unintentionally.

When the ignition is on and the up to one-year old child is seated in the child restraint system on the passenger's seat the indicator lamp „PASSENGER AIRBAG OFF" must be on.

If the "PASSENGER AIRBAG OFF" indicator lamp does not light up, it could indicate a fault in the system.

In this case:

- f On vehicles **with** key-operated airbag deactivation device: Switch to position OFF.
- f On vehicles **without** key-operated airbag deactivation device: Do not use a child restraint system in the front passenger's seat.
- f Have the fault remedied at your nearest authorized Porsche dealer.

Child restraint system for children older than one year

Your vehicle is equipped with a weight sensing system for the passenger's seat in accordance with U.S. Federal Motor Vehicle Safety Standard 208. Depending on the weight acting on the passenger's seat, the passenger's airbag will automatically be switched on or off.

Small adult passengers

Make sure that the PASSENGER AIRBAG OFF indicator lamp does not light up.



Risk of serious personal injury or death due to the passenger's airbag not triggering.

When the ignition key is inserted and the small adult passenger is seated on the passenger's seat, the indicator lamp "PASSENGER AIRBAG OFF" must be off.

If the "PASSENGER AIRBAG OFF" indicator lamp lights up, it could indicate a fault in the system.

In this case:

- f The passenger should sit in the rear seat until the fault is repaired.
- f Have the fault remedied at the nearest authorized Porsche dealer.

Automatic locking retractor

- f Do not install a child restraint system in the Sports bucket seat. The Sports bucket seat cannot be equipped with the LATCH system.

The safety belts for the front passenger and rear seats are equipped with an automatic locking retractor for securing the child restraint system. When activated, this retractor allows you to securely fasten the child restraint system in place so that inadvertent movements will not occur.



The use of a child restraint system on the front passenger seat can result in serious personal injury or death to the child from an airbag deployment.

To reduce risk of injury from an inflating airbag in an accident, Porsche strongly recommends:

- f Under all normal circumstances, forward facing child seats must be placed in the rear.

Before transporting a child on the passenger's seat:

- f Please see the chapter "CHILD RESTRAINT SYSTEMS" on Page 50.



Risk of serious personal injury or death to the child, when excessive force is acting on the passenger's seat due to the seat belt. In such cases, the passenger's airbag can be switched on unintentionally.

- f After fastening the child restraint system, do not adjust the seat.
- f Check the condition of the passenger's airbag shown by the indicator lamp in the central console.

Activating the automatic locking retractor

1. If a child restraint system must be fastened to the passenger's seat, adjust the passenger's seat as far away from the airbag as possible.
2. Fasten child seat.
3. Pull the safety belt retractor completely out. At this point the locking mechanism is activated.
4. Insert the safety belt tongue into the buckle and make certain that it is properly latched. Make no more adjustments to the seat.
5. Allow the safety belt to retract until it is tight on the child restraint system. You may further tighten the belt by pulling on it to allow more of it to retract. Make sure that excessive seat belt forces do not occur by moving the seat with the child seat installed.

Releasing the safety belt

1. Unbuckle the safety belt latch.
2. Then make certain that the belt has fully retracted. At this point the automatic locking feature will be disengaged. Seek appropriate advice from your authorized Porsche dealer about the possible installation of a Porsche child restraint system.

LATCH System

Child seat bracket on the passenger's seat

- f Do not install a child restraint system in the Sports bucket seat. The Sports bucket seat cannot be equipped with the LATCH system.

The key switch for switching off the passenger's airbag and the LATCH attachment bracket are not installed at the factory. They can be retrofitted (**not on vehicles with Sports bucket seats**).

- f Please see your authorized Porsche dealer.

Porsche recommends the use of a Porsche Child Seat with Lower Anchorage and Tether for Children system (LATCH).

These systems have been tested and adjusted to the interior of your Porsche and the appropriate child weight groups. Other systems have not been tested and could entail an increased risk of injury.

You can obtain child seats that are LATCH compatible at your authorized Porsche dealer.

- f Always observe the separate installation instructions for your child seat.
- f Please see the chapter "CHILD RESTRAINT SYSTEMS" on Page 50.



Installing a LATCH child seat system

1. Secure the child seat to retaining lugs **A** as outlined in the instruction manual for the child seat.
2. Pull the child seat to check that both fastening points are engaged correctly.

Note

- f Make sure that the key switch is switched to AUTO once the child seat has been removed, in order to provide protection to the adult occupants.

Child Restraint Anchorages

(Coupé and Targa)

f Please see the chapter "AUTOMATIC LOCKING RETRACTOR" on Page 53.

f **Do not install a child restraint system in the Sports bucket seat. The Sports bucket seat cannot be equipped with the LATCH system.**

If your child restraint seat or seats require the use of a tether strap, you will want to use the anchor points provided behind the rear seat backrests under the carpet.

To ensure proper installation, see your authorized Porsche dealer.

Note

If a child seat with top tether is adapted for use on the front seat, the rear right (passenger's side) anchor point must be used for anchoring the top tether. It is then not permitted for a passenger to use the rear right (passenger's side) seat.



Warning!

Child restraint anchorages are designed to withstand only those loads imposed by correctly fitted child restraints. Under no circumstances are they to be used for adults safety belts or harnesses. Such use could result in serious personal injury or death.

f Do not misuse the child restraint anchorages. They are not designed to withstand loads imposed by adults.

f Only attach **one** child seat tether per anchorage.

Rollover Protection System

The Rollover Protection System on the **Cabriolet** consists of two supplemental safety bars that together with the front windshield frame help to create occupant survival space in case of rollover. Because of the extreme and unpredictable forces which can be encountered in a rollover, it is not possible to guarantee that occupants will be protected from all contact with exterior objects or the ground. However, the Rollover Protection System is designed to maintain the occupant survival space.

The Rollover Protection System is activated automatically in the event of an accident or extreme driving situation.

The protective devices are located behind each rear seat and rapidly deploy within a fraction of a second. If necessary, the seat-belt tensioners will be activated.

- f Please see the chapter "BELT TENSIONER" on Page 41.

They can deploy under:

- Extreme tilting of the vehicle.
- Loss of ground contact (e.g. Going over the crest of a hill at high speed).

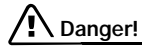

Danger!

Risk of death or serious injury.

- f Do not block area of supplemental safety bars with objects.
In the event of a deployment event, such objects could potentially prevent such deployment from occurring, or such objects could impact the car occupants at high speed.
- f Do not tamper with or work on wiring and or components of Rollover Protection System.
- f All work regarding this system must be carried out by your authorized Porsche dealer.
- f Check functions and periodic service intervals according to maintenance schedule (see your authorized Porsche dealer).

To avoid damage to the convertible top:

- f If the supplemental safety bars are extended for any reason, do not open or close convertible top.



Warning light

Faults in the Rollover Protection System are indicated by the airbag warning light in the instrument panel.

Extension of the supplemental safety bars is no longer ensured.

- f See your authorized Porsche dealer immediately and have the fault remedied.

Lowering the supplemental safety bars after deployment

- f Have this work performed by an authorized Porsche dealer.



Sports Exhaust System

Switching on and off

The sports exhaust system can be switched on and off when the ignition is switched on using button **A**.

When the sports exhaust system is switched on, the light-emitting diode in the button lights up.



Parking Brake

Parking brake force is mechanically transferred to the rear wheels by means of cables.

- f Use the parking brake only after the vehicle has come to a full stop.

Setting the parking brake

- f Pull the lever **all the way up** (arrow).
With the ignition on, the parking brake warning lights in the instrument panel and on-board computer will come on if the lever is even slightly raised. A firm pull upward is required to properly engage the parking brake. If the brake is not fully set, the vehicle may roll without control.
- f Move the selector lever to "P" (PDK) or move the gearshift lever to reverse or first gear (Manual transmission).
- f Before exiting the vehicle, make sure that the parking brake is fully set and the vehicle is not moving at all.

Danger!

Risk of serious personal injury or death. A partially engaged parking brake may allow the vehicle to roll, causing serious personal injury or death to any person in its path.

- f Engage the parking brake fully.

Releasing the parking brake

- f Pull the lever slightly up as you depress the release button, and then push the lever all the way down.

BRAKE Parking brake warning light USA

Parking brake warning light Canada

The warning lights in the instrument panel and on-board computer will go out after the parking brake is fully released.

The warning lights are not an indicator that the parking brake is fully set; it is only intended to be a warning to release the parking brake before driving the car.

Caution!

A partially engaged brake will overheat the rear brakes, reduce their effectiveness and cause excessive wear.

- f Release the parking brake fully.

- f When parking your car, always set the parking brake by pulling all the way up on the lever.
- f Move the selector lever to "P" (PDK) or move the gearshift lever to reverse or first gear (Manual transmission).
- f On hills also turn the front wheels towards the curb.

Brakes

- f Make it a habit to check the operation of your brakes before driving.

Keep in mind that the braking distance increases very rapidly as the speed increases. At 60 mph or 100 km/h, for example, it is not twice but four times longer than 30 mph or 50 km/h. Tire traction is also less effective when the roads are wet or slippery.

- f Therefore, always maintain a safe distance from the car in front of you.

Vehicles without Porsche Ceramic Composite Brake (PCCB)

Even though the brake discs consist of alloyed grey cast iron, they will unavoidably start to corrode if your car is parked for an extended period. The brakes will tend to "rub" as a result.

The nature, extent and effects of corrosion depend on the amount of time the vehicle was parked, whether granular or liquid road salt was spread and whether grease-dissolving agents were used in car washes.

To prevent corrosion of the brake discs, "brake them dry" before parking the car. If the braking comfort is noticeably impaired, we recommend having the brake system checked by experts at an authorized Porsche dealer.

Brake system function

Your Porsche is equipped with a power assisted hydraulic dual circuit brake system with disc brakes at the front and rear.

Both circuits function independently. One brake circuit operates the front and the other operates the rear.

If one brake circuit has failed, the other will still operate. However, you will notice an increased pedal travel when you apply the brakes.

Failure of one brake circuit will cause the stopping distance to increase.

Warning!

Risk of an accident, resulting in serious personal injury or death.

In the unlikely event of hydraulic failure of one brake circuit:

- f Push the brake pedal down firmly and hold it in that position.
A mechanical linkage activates the second circuit, and you will be able to bring the vehicle to a stop.
- f After bringing your vehicle to a complete stop, avoid driving the vehicle and instead have it towed to the nearest authorized Porsche dealer for repair.

Brake system warning light

You can check the functionality of the brake system warning light by switching the ignition to the "On" position and verifying that the warning light illuminates.

BRAKE Brake warning light USA

Brake warning light Canada

If the warning lights in the instrument panel and on-board computer go on while driving, the brake fluid level may be too low, or (if the brake pedal travel has increased) one of the two brake circuits may have failed.

A greater braking pressure will be required, stopping distances will be longer and the braking behavior will change, particularly in curves.

With correctly adjusted brakes, and a correctly working brake system, the pedal travel to the point of brake actuation should be 1-3/16 in. to 1-9/16 in. or 30 to 40 mm.

Whenever the brake pedal travel exceeds this distance, have the brake system checked.

Brake pedal

Warning!

Risk of an accident, resulting in serious personal injury or death.

Any obstruction of the brake pedal could increase the stopping distance.

- f Always check the movement of the brake pedal before driving and make sure that it is not obstructed by a floor mat or any other object.
- f Secure the floor mat to prevent it from sliding into positions that could interfere with the safe operation of your vehicle.
Your Porsche dealer will be glad to offer you nonskid floor mats of the correct size.

Note

In case one of the two brake circuits fails, increased pedal travel is required to bring your vehicle to a full stop.

Warning!

To avoid overheating and premature wear of the brakes:

- f Before descending a steep grade, reduce speed and shift the transmission into a lower gear or driving position to control speed.
- f Do not "ride the brakes" by resting your foot on the pedal when not intending to apply brake pressure.
- f Do not hold the pedal down too long or too often.
This could cause the brakes to get hot and not function properly.

Brake booster

The brake booster assists braking only when the engine is running.

When the car is moving while the engine is not running, or if the brake booster is defective, more pressure on the brake pedal is required to bring the car to a stop. If this happens, ABS and PSM will also not operate.

Moisture or road salt on brakes affects braking. When the vehicle is driven on salted or sanded roads for extended periods, the brakes should be washed down thoroughly about every 2 weeks. An automatic carwash facility cannot do this job properly.

Brakes will dry after a few cautious brake applications.

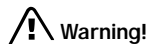

Risk of an accident, resulting in serious personal injury or death.

Driving through water may reduce the traction.

Moisture on brakes from road water, car wash, or coating of road salt may affect braking efficiency.

- f Cautiously apply brakes to test brakes after exposure to road water, etc.

Brake wear

Your car has excellent brakes, but they are still subject to wear. The rate at which they wear depends on how the brakes are used.

- f Have the brake system inspected at the intervals recommended in your Maintenance Booklet.

Brake system warning light

You can check the functionality of the brake system warning light by switching the ignition to the "On" position and verifying that the warning light illuminates.

Warning light USA



Warning light Canada

If the warning lights in the instrument panel and on-board computer stay on when the engine is running or come on while driving, the brake pads are worn excessively.

- f Do not continue to operate the vehicle. Have your authorized Porsche dealer inspect or replace the brake pads.

Brake pads

Wear on the brake pads and brake discs depends to a great extent on the driving style and the conditions of use and therefore cannot be expressed in actual miles on the road.

The high-performance brake system is designed for optimal braking effect at all speeds and temperatures.

Certain speeds, braking forces and ambient conditions (such as temperature and humidity) therefore might cause "brake noises".

New brake pads or linings

New brake pads and brake discs have to be "broken in", and therefore only attain optimal friction when the car has covered several hundred miles or km.

The slightly reduced braking ability must be compensated for by pressing the brake pedal harder. This also applies whenever the brake pads and brake discs are replaced.

ABS Brake System (Antilock Brake System)

The ABS system represents a major contribution to the enhancement of active safety in your vehicle. This system prevents the wheels from locking in a panic stop on almost all road surfaces.

With the ABS system in your vehicle, the following areas are enhanced:

Steering, vehicle remains steerable under all braking forces when ABS is engaged.

Good directional control, no swerving caused by locking of wheels under braking conditions.

Shorter stopping distance, stopping distances are usually reduced because controlled braking is maximized.

Prevention of wheel lock up, no brake-induced sliding and thus no localized tire wear from emergency braking.

The crucial advantage of the ABS system over a conventional brake system is in the area of maintaining directional control and maneuverability of the car in emergency situations.

Warning!

The increased control that is provided should not induce you to take greater risks with your safety. The limits dictated by the laws of physics cannot be overcome, even with ABS. The risk of accidents due to inappropriate speed cannot be reduced, even by the ABS. The driver bears the responsibility for all driving maneuvers.

- f Adapt your driving style to the prevailing road and weather conditions.
- f Obey all traffic laws.

Other vehicles not equipped with the ABS system may not be able to maintain control, especially on wet or poor road surfaces and thus may be more likely to impact you from behind.

- f To minimize that risk, use your ABS system to increase your ability to maneuver to avoid dangerous situations and not merely to try to stop in the shortest distance possible.

Operation of the ABS system

A wheel speed sensor is mounted to each of the four wheels. If wheel lock-up of either of the front wheels or the rear wheels is sensed during braking, the brake pressure is adjusted automatically until the wheel no longer slips.

If braking forces approach the wheel lock-up point for all wheels (panic braking) the ABS system will intervene to provide a rapid rhythmic braking. The proper operation of ABS is perceived by the driver as a pulsating brake pedal in conjunction with audible noise and perhaps some vibration.

- f If you experience these sensations while driving on a road surface with questionable traction, reduce vehicle speed appropriate for the prevailing road conditions.
- f If full braking should be necessary, press the brake pedal all the way down throughout the entire braking procedure, regardless of the pulsating pedal. Do not ease up on pressure applied to the pedal.

The functional readiness of all the main electrical components of the ABS is checked by an electronic monitoring system both before and while you drive.

ABS Warning light USA

Warning light Canada

When the ignition is switched on the ABS warning light will light up while the system is electronically interrogated and goes out when the engine is started if the check is not yet complete.

If the ABS warning lamp fails to go out, this indicates that ABS has been deactivated due to a fault. If the warning lights in the instrument panel and on-board computer light up while you are driving, this indicates that a fault has occurred. In both cases, normal braking, as in vehicles without ABS, is still retained.

The ABS system should, however, be examined at an authorized Porsche dealer immediately to prevent the occurrence of further faults.

- f If the ABS system becomes inoperative, take your vehicle to your authorized Porsche dealer immediately.

Warning!

Risk of an accident, resulting in serious personal injury or death.

The control unit of the ABS brake system is set for standard tire size. **If non-standard tires are installed, the control unit may misinterpret the speed of the vehicle, because of the variant data it receives from the sensors on the axles.**

- f Use only tire makes and types tested by Porsche.

Clutch Pedal

The clutch pedal must be depressed fully before the starter will engage.

Warning!

Risk of an accident, resulting in serious personal injury or death.

- f Always check the movement of the clutch pedal before driving and make sure that it is not obstructed by a floor mat or any other object.
- f Secure the floor mat to prevent it from sliding into positions that could interfere with the safe operation of your vehicle.
Your Porsche dealer will be glad to offer you nonskid floor mats of the correct size.

To avoid damage to the clutch and transmission:

- f Always depress the clutch pedal fully when changing gears.
- f Do not hold the car on a steep grade with the clutch pedal partially depressed.

Should the free travel of the clutch pedal suddenly become larger, it could mean a malfunction of the clutch.

- f See your Porsche dealer for correction.

Porsche Traction Management (PTM)

With PTM, the engine power is variably distributed to the front and rear wheels.

Power distribution between the front and rear axles is performed by a map-controlled multiple-disc clutch.

Distribution of the engine power also depends on the difference in wheel speed between the two axles.

The multiple-disc clutch always delivers sufficient drive power to the front wheels to ensure optimum propulsion even on an unfavorable road surface.

In combination with the Porsche Stability Management (PSM), the PTM ensures optimum handling and high driving stability.

Warning!

The increased control that is provided should not induce you to take greater risks with your safety. The limits dictated by the laws of physics cannot be overcome, even with PTM. The risk of accidents due to inappropriate speed cannot be reduced, even by PTM. The driver bears the responsibility for all driving maneuvers.

- f Adapt your driving style to the prevailing road and weather conditions.
- f Obey all traffic laws.

Dynamometer testing procedure

Some U.S. states and Canadian provinces conduct emissions inspection/maintenance testing involving the use of two-wheel dynamometer.

A two-wheeled dynamometer is a treadmill type device upon which a single axle of the car, the driving axle of the vehicle, rotates to simulate vehicle operation on the road while the vehicle remains stationary.

Your vehicle has a full-time four-wheel drive system which cannot be disabled. Severe damage to the powertrain can result if tested on a two-wheel dynamometer.

Warning!

Risk of severe powertrain damage and a possible unexpected movement of the vehicle.

- f Do not test your vehicle on a two-wheel dynamometer.
- f Advise the emission station of this warning before testing the vehicle.

Brake tests

Brake tests must be performed only on plate-type test stands or roller test stands.

The ignition must be off.

The following limit values must not be exceeded on roller test stands:

- Testing speed 5 mph (8 km/h)
- Test duration 20 seconds

Handbrake tests

Handbrake tests on the roller test stand must **only be carried out with the ignition switched off.**

Balancing wheels on the vehicle

During finish balancing of the wheels, the vehicle must be hoisted and all the wheels able to rotate freely.

Towing

- f Please see the chapter "TOWING" on Page 280.

Wheels/Tires

The PTM control unit is adapted to the approved tire sizes. The use of non-approved tire sizes may lead to deviations in wheel speeds and it may influence handling or result in the PTM switching off.

Sport Mode

A sportier car set-up is obtained when Sport mode is switched on. Interventions by the Porsche control systems are intentionally shifted towards greater agility and driving performance:

- PASM (Porsche Active Suspension Management) is automatically changed to Sport mode, resulting in a stiffer suspension setup.
- When Sport mode is active, the PDK transmission switches to a sporty gear-changing map and shortens the gear shifting times. Gear changes take place faster, but fuel consumption is also increased.
PSM (Porsche Stability Management) control gives a sportier road-feel to the vehicle. PSM interventions take place later than in Normal mode. The driver can maneuver the vehicle with greater agility at its performance limits, without having to dispense with the assistance of PSM in emergency situations. This helps to achieve optimal lap times, particularly on race circuits with a dry road surface.
- The electronic accelerator pedal reacts sooner, and the engine is more responsive to throttle inputs. When Sport mode is switched on, this function is activated only after the driver has floored the accelerator pedal or released it briefly.

- The rpm limiter characteristic is "harder", i.e. the engine is immediately throttled when the performance limits are reached (only in manual selection mode for vehicles with PDK transmission).
- f Please observe the chapters on PSM, PASM and PDK.

Switching Sport mode on and off

Switching Sport mode on and off simultaneously activates and deactivates the Sport mode in PASM.

If PASM Sport mode was activated with the PASM button, PASM remains active.

After the ignition is switched off, Sport mode is automatically reset to Normal mode.

SPORT button

- f Press SPORT button **A** in the center console. When Sport mode is switched on, the light-emitting diode in the SPORT button is lit.

A sporty gear-changing map is enabled and the gear shifting times are shortened for the PDK transmission.

A sporty driving style is recognized more quickly and the gear-changing speeds are adapted to driving performance.

Deceleration downshifts are commenced earlier. Downshifts are made during slight decelerations, even at higher engine speeds.

- f Please see the chapter "SPORT MODE ("SPORT" AND "SPORT PLUS" MODES)" on Page 172.



881-031



882-032



882-033

**SPORT PLUS button
(only on vehicles with PDK transmission)**

In "Sport Plus" mode, the PDK transmission changes to a shift program designed for driving on race circuits. 7th gear is not selected. The gear-changing performance is enhanced significantly again compared with "Sport" mode.

- f Please see the chapter "SPORT MODE ("SPORT" AND "SPORT PLUS" MODES)" on Page 172.
- f Press SPORT PLUS button **B** in the center console.
When Sport mode is switched on, the light-emitting diode in the SPORT PLUS button is lit.

When mode "Sport" is switched on, the logo SPORT appears next to the digital speedometer.

When mode "Sport Plus" is switched on, the logo SPORT PLUS appears next to the digital speedometer.

Porsche Stability Management (PSM)

PSM is an active control system for stabilization of the vehicle approaching the performance limits of driving maneuvers.



Warning!

Risk of an accident, resulting in serious personal injury or death.

The increased control that is provided should not induce you to take greater risks with your safety. The limits dictated by the laws of physics cannot be overcome, even with PSM. The risk of accidents due to inappropriate speed cannot be reduced, even by PSM. The driver bears the responsibility for all driving maneuvers.

f Adapt your driving style to the prevailing road and weather conditions.

f Obey all traffic laws.

Sensors at the wheels, brakes, steering system and engine continuously measure:

- Speed
- Direction of travel (steering angle)
- Lateral acceleration
- Rate of turn about the vertical axis
- Longitudinal acceleration

PSM uses these values to determine the direction of travel indicated by the driver.

PSM intervenes and helps to correct the course if the actual direction of motion deviates from the chosen course (steering-wheel position):

It brakes individual wheels as needed. In addition, the engine power may be manipulated in order to stabilize the vehicle.

The events below inform the driver of PSM control operations and warn him/her to adapt his/her driving style to the road conditions:

- The multifunctional information light on the instrument panel flashes.
- Hydraulic noises can be heard.
- The vehicle decelerates and steering-wheel forces are altered as the PSM controls the brakes.
- Reduced engine power.
- The brake pedal pulsates and its position is changed during braking. In order to achieve full vehicle deceleration, foot pressure must be increased after the brake pedal has begun vibrating.

Examples of PSM control operations

- If the front wheels of the vehicle drift on a bend, the rear wheel on the inside of the bend is braked and the engine power is reduced if necessary.
- If the rear of the vehicle swings out on a bend, the front wheel on the outside of the bend is braked.

Additional braking functions

- Pre-filling the brake system:
The brake system is prepared for possible subsequent emergency braking if the accelerator pedal is released suddenly and quickly. The brake system is prefilled and the brake pads are already applied gently to the brake discs.
- Brake booster:
In the event of an emergency braking operation where the pedal force is insufficient, a brake booster provides the braking pressure necessary for maximum deceleration at all 4 wheels.

Advantages of PSM

- Best possible traction and lane-holding ability in all driving situations – even on road surfaces with varying friction.

- The system compensates for undesired lateral vehicle reactions when the driver releases the accelerator pedal or brakes when cornering. This compensation functions up to the maximum lateral acceleration.
- PSM actively stabilizes the vehicle as required during dynamic driving maneuvers (e.g. rapid steering movements, during lane changes or on alternating bends).
- Improved braking stability on bends and on different or varying road surfaces.
- It improves braking function and shortens stopping distance in the event of emergency braking.

Readiness for operation

PSM is switched on automatically every time you start the engine.

PSM should always be switched on during "normal" driving.

However, it may be advantageous to switch off PSM temporarily in exceptional situations, for example:

- On a loose surface or in deep snow,
- When "rocking" the vehicle free and
- When using snow chains.



Switching off PSM

- f Press PSM OFF button.

PSM is switched off after a short delay. The light-emitting diode in the button is lit up. When the PSM is switched off, the PSM multifunctional light on the instrument panel is lit **and** a message is shown on the on-board computer. An acoustic signal also sounds.

Note

When PSM is switched off, the additional braking functions are deactivated. Automatic reactivation in emergency situations is linked to the PSM control.

The following functions stabilize the vehicle in emergency situations, even with PSM switched off:

- When PSM is off, the vehicle is stabilized as soon as one of the two front wheels enters the ABS control range.
- When PSM is off and Sport mode is on, the vehicle is stabilized as soon as both front wheels enter the ABS control range.

One-sided spinning of the wheels is prevented, even with PSM switched off.

Switching PSM back on

- f Press PSM OFF button. PSM is switched on after a short delay. The light-emitting diode in the button and the PSM multifunctional light on the instrument panel go out. The on-board computer shows a message.

Sport mode

A sportier car set-up is obtained when Sport or Sport Plus mode is switched on. PSM interventions are later than in Normal mode; the vehicle can be maneuvered with greater agility at its performance limits, without dispensing with the assistance of PSM in emergency situations. This helps to achieve optimal lap times, particularly on race circuits and a dry road surface.



PSM multifunctional light

- The multifunctional light on the instrument panel lights up for a lamp check when the ignition is switched on.
- The light indicates a control operation by flashing, including when PSM is switched off (brake control in the event of one-sided wheel spin).
- In conjunction with a message on the on-board computer, the light indicates that PSM is switched off. An acoustic signal also sounds.
- The light indicates a fault in conjunction with a message on the on-board computer. PSM is out of order.

- f Please have the fault remedied at an authorized Porsche dealer.
- f Please see the chapter "PUTTING VEHICLE INTO OPERATION" on Page 263.

Towing

- f Please see the chapter "TOWING" on Page 280.

Checks on test stands

Brake tests

Brake tests must be performed only on plate-type test stands or roller test stands.

The ignition must be switched off.

The following limit values must not be exceeded on roller test stands:

- Testing speed 5 mph (8 km/h)
- Test duration 20 seconds

Handbrake tests

Handbrake tests on the roller test stand must be performed **only with the ignition switched off**.



Porsche Active Suspension Management (PASM)

PASM makes two running-gear setups available to the driver: "Normal" and "Sport".

The selection is made via a button on the center console.

In Normal mode the running gear is in a comfortable setup.

Sport mode offers very sporty shock absorber tuning.

The variable suspension system selects the appropriate damping level for each wheel according to the situation and driving conditions.

Example:

If the vehicle is driven in a very sporty manner in Normal mode, PASM automatically adapts the shock-absorber behavior to the driving situation accordingly.



Switching on PASM Sport mode

- Press PASM button in the center console. When PASM Sport mode is switched on, the light-emitting diode in the button is lit up **and** a message is shown on the on-board computer.

Switching off PASM Sport mode

- Press PASM button in the center console. The light-emitting diode in the button goes out **and** the on-board computer displays a message.

After the ignition is switched off, PASM is automatically reset to Normal mode.

Retractable Rear Spoiler

The rear spoiler improves driving stability, especially at higher speeds.

Warning!

Risk of accident. If the rear spoiler cannot be extended, driving stability will be adversely affected by increased rear axle lift, which could lead to loss of control.

- Adapt your driving style and speed to the changed driving behavior.
- Have the fault remedied at an authorized Porsche dealer.

Risk of injury during manual retraction or extension of the rear spoiler with the vehicle stationary.

- Make sure that no persons or objects are within the range of movement of the rear spoiler.

Risk of damage from pushing the vehicle by the spoiler.

- Do not push the vehicle at the spoiler.

Automatic mode

The limits for automatic extension and retraction of the spoiler depend on various circumstances (e.g. driving speed, engine compartment temperature).

If automatic control fails, a warning message is displayed by the on-board computer.

Engine compartment temperature under 122 °F/55 °C

Spoiler extends at 75 mph/120 km/h and retracts at 37 mph/60 km/h.

Engine compartment temperature over 140 °F/60 °C

Spoiler extends at 50 mph/80 km/h and retracts at 19 mph/30 km/h.



Manual control

When the ignition is on, the rear spoiler can be extended and retracted manually using the button in the center console.

Extending

- Press button briefly.
The spoiler extends to its final position.
The light-emitting diode in the button lights up.

Retracting a manually extended rear spoiler

- at speeds between 0 and 20 mph (0 and 30 km/h)**
Press and hold button until the rear spoiler has reached its final position.
The light-emitting diode in the button goes out.
The rear spoiler changes to automatic mode.
- at speeds between 20 and 60 mph (30 and 100 km/h)**
Press button briefly.
The rear spoiler retracts, the light-emitting diode in the button goes out.
The rear spoiler changes to automatic mode.
- at speeds over 60 mph (100 km/h)**
Press button briefly.
The rear spoiler remains extended, the light-emitting diode in the button goes out.
The rear spoiler changes to automatic mode.

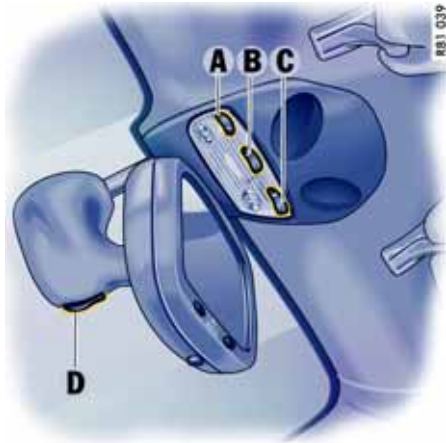

A, C - Switch for reading light on driver/passenger side
 B - Switch for interior light and footwell lights
 D - Orientation light

Interior Lights

- f Please see the chapter "LOAD SWITCH-OFF AFTER 2 HOURS OR 7 DAYS" on Page 258.

For vehicles with automatic anti-dazzle mirrors

- f Switch off the automatic anti-dazzle operation of the mirrors before you switch on the interior light. Otherwise the mirrors may accidentally swivel into the anti-dazzle position.

Interior lights, reading lights

Switching off

- f Press left half of switch.

Switching to continuous illumination

- f Press right half of switch.

Switching on and off automatically

- f Move switch to center position.

The interior and footwell lights are **switched on** when a door is unlocked or opened or when the ignition key is withdrawn from the ignition lock.

The lights are **switched off** with a delay of approx. 2 minutes after the doors are closed. The light goes out immediately as soon as the ignition is switched on or the vehicle is locked.

Orientation light

A light-emitting diode at the bottom of the interior mirror improves orientation in the passenger compartment when it is dark.

Note on operation

On vehicles with the Sport Chrono Package Plus, the brightness of the orientation light can be changed in PCM.

- f Please observe the chapter "Individual Memory" in the separate PCM operating instructions.

Parking Aids

Parking assistant

When the driver backs up, the parking assistant system indicates the distance between the car and a large obstacle behind it, by means of signal tones.

Warning!

Risk of serious personal injury or death. Parking assistant cannot detect small objects such as children and pets. Despite use of the parking assistant system, the driver is still responsible for taking due care and assessing obstacles when backing up.

- f Make sure that no persons, especially small children, animals or obstacles are within the maneuvering area.

The parking assistant system is activated automatically when reverse gear is selected and the ignition is on.

Note

Be aware that the parking assistant system is **not** switched on if the car rolls backward without reverse gear being engaged.



Ultrasound sensors

Sensors

Four ultrasound sensors in the rear bumper measure the distance to the closest obstacle.

- Range middle sensors around 60 in./150 cm
- Range outer sensors around 24 in./60 cm

Obstacles cannot be detected in the "blind" sensor area (e.g. near the ground).

Note

The sensors must always be kept free of dirt, ice and snow in order to ensure that they are fully functional.

Caution!

To avoid damaging the sensors:

- f Maintain sufficient distance when cleaning with steam-jet units.

Signal tones/function

When reverse gear is selected, the parking assistant confirms that it is switched on by issuing a **short signal tone**.

A detected obstacle is signalled by an **intermittent tone**. The intervals decrease as the obstacle is approached.

A **continuous tone** sounds when the distance becomes less than one foot. This continuous tone can stop if the obstacle is approached closer than one foot.

The radio volume should not be so loud as to drown out the signal tones.

Limits of ultrasonic measurement

The parking assistant system cannot detect:

- sound-absorbing obstacles (e.g. powder snow),
- sound-reflecting obstacles (e.g. glass surfaces, flat painted surfaces)
- and very thin obstacles.
- Other ultrasound sources (e.g. pneumatic brakes of other vehicles, jackhammers) can interfere with detection of obstacles.

Fault indication

The parking assistant system indicates a fault in two ways:

- After reverse gear has been selected, the short signal tone is followed by a continuous tone of the **same** pitch:
This indicates that sensors are soiled or covered with ice.
- After reverse gear has been selected, the short signal tone is followed by a continuous tone with a much **lower** pitch:
This indicates a general system fault.
Please have the fault remedied at an authorized Porsche dealer.



A - Control switch for door mirror adjustment

Swivelling down mirror glass as a parking aid

- f Please see the chapter "SEAT MEMORY" on Page 33.
- When reverse gear is engaged, the mirror glass on the passenger's side swivels down slightly to show the curb area.

Preconditions

- Vehicle must be equipped with seat memory.
- Set the control switch **A** to "passenger's side".
- Reverse gear must be engaged.

Returning mirror glass to its original position

- f Drive forwards with a speed of over 4 mph (6 km/h) **or**
- f Set the control switch **A** to "driver's side".



- 0 - Initial position
- 1 - Ignition on
- 2 - Start engine
- 3 - Ignition off

Ignition/Starter Switch with anti-theft Steering Lock

The ignition lock has a total of four ignition lock positions.

The ignition key rebounds to the initial position from every ignition lock position.

f For your safety, fasten safety belts.

- f Please see the chapter "IMMOBILIZER" on Page 15.

74 Operation, Safety

- f Please see the chapter "KEY WITH RADIO REMOTE CONTROL" on Page 16.

Before starting the engine

- f Apply the footbrake.
- f **Manual transmission:**
Move the gearshift lever into neutral.
The clutch pedal must be depressed fully before the starter will engage.
- f **In vehicles with PDK transmission:**
Move PDK selector lever to position **P** or **N**.

Switch position 0

Initial position

The ignition key cannot be withdrawn when the ignition is switched on or when the engine has been started.

To withdraw the ignition key:

- f Stop the vehicle.
- f **In vehicles with PDK transmission:**
Move PDK selector lever to position **P**.
- f Switch ignition off.
- f Remove ignition key.

Switch position 1

Ignition on

- f Turn ignition key to position **1**.
Ignition is switched on.

Note on operation

All electrical equipment can be switched on.

- f Please see the chapter "WARNINGS ON THE INSTRUMENT PANEL AND THE ON-BOARD COMPUTER" on Page 158.

Switch position 2

Start engine

- f Turn ignition key to ignition lock position 2.
- f Please see the chapter "STARTING PROCEDURES" on Page 77.

Switch position 3

Ignition off

- f Turn ignition key to ignition lock position 3.

Note on operation

The vehicle battery discharges if the ignition key is left inserted.

If the vehicle battery is dead, the key can only be pulled out of the ignition lock if the emergency operation is performed:

- f Please see the chapter "EMERGENCY OPERATION – PULLING OUT THE IGNITION KEY" on Page 76.

Locking the steering column

Automatic locking

The steering column is automatically locked when the ignition key is withdrawn from the ignition lock.

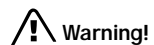

Risk of an accident, resulting in serious personal injury or death.

The steering wheel will lock and will cause loss of steering.

- f Never remove key from the ignition lock or turn the key off while the vehicle is moving.
- f **Always withdraw the ignition key** when leaving the vehicle.

Automatic unlocking

The steering column is unlocked when the vehicle is unlocked with the radio remote control.

Note

- f To avoid discharging the battery, always remove the ignition key from the ignition lock. Please see the chapter "BATTERY" on Page 261.

Gong

If you leave the key in the ignition/steering lock, a gong will sound when the driver's door is opened. This is a reminder to remove the key.

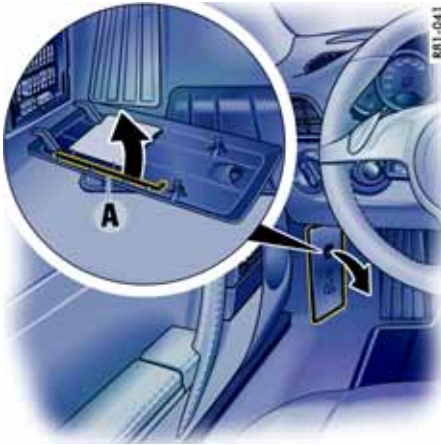

Emergency operation – pulling out the ignition key

If the vehicle battery is dead, the key can be pulled out only if the emergency operation is performed.

1. Grasp the fuse box cover at the finger hole and pull it off.
2. Unclip metal hook **A** on the inside of the cover.

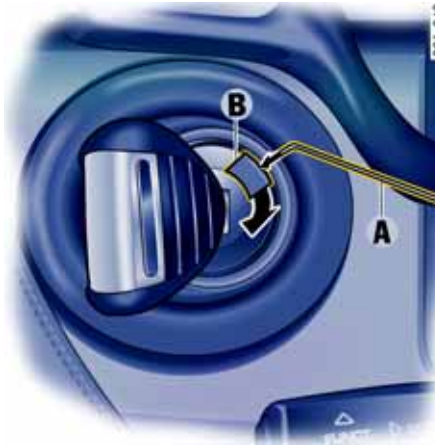

3. Use metal hook **A** to remove the plastic lid **B** from the ignition lock. Make sure that plastic lid **B** is not lost.

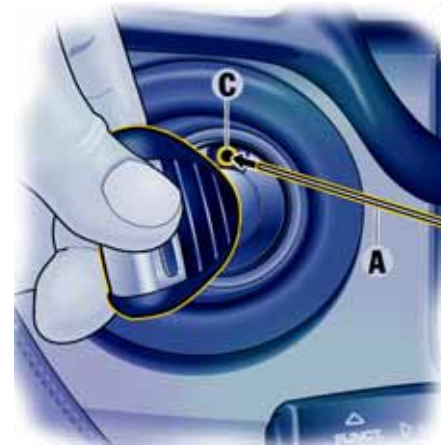

4. Turn ignition key counter-clockwise as far as it will go.
5. Press metal hook **A** into opening **C**. An unlocking sound will be heard.
6. Turn the ignition key to initial position (0) and remove.
7. Re-fit the plastic lid **B**.

Starting Procedures

- f Please see the chapter "IMMOBILIZER" on Page 15.
- f Please see the chapter "EMISSION CONTROL SYSTEM" on Page 218.

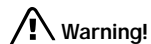

Warning!

Serious injury or death may result if you are involved in a collision without having fastened the safety belts.

- f Fasten safety belts before driving away.

Before starting the engine

- f Apply the footbrake.
- f **Manual transmission:**
Move the gearshift lever into neutral.
The clutch pedal must be depressed fully before the starter will engage.
- f **In vehicles with PDK transmission:**
Move PDK selector lever to position **P** or **N**.

Temperature sensors on the engine automatically provide the correct fuel/air mixture required for starting.

Therefore, it is **not necessary to depress the accelerator pedal** while starting a cold or a warm engine.

Starting the engine

- f Turn ignition key to ignition lock position **2**.
- f As soon as the engine starts, release the ignition key.

The first operation of the starter is ended automatically when the engine starts.

If the engine does not start, subsequent starter operations will not be ended automatically.

If the engine fails to start after 10 or 15 seconds of cranking:

- f Wait about 10 seconds before engaging the starter again.
- f When starting the engine, be ready to drive immediately.
Drive vehicle at moderate speeds and avoid engine speeds above 4,200 rpm during the first 5 minutes.
- f Do not let the engine idle to warm up.



Danger!

Engine exhaust fumes have many components which you can smell. They also contain carbon monoxide (CO), which is a colorless and odorless gas.

Carbon monoxide can cause unconsciousness and even death if inhaled.

- f Never start or let the engine run in an enclosed, unventilated area.
It is not recommended to sit in your car for pro-

longed periods with the engine on and the car not moving.

An unattended vehicle with a running engine is potentially hazardous. If warning lights should come on to indicate improper operation, they would go unnoticed.

- f Never leave the engine idling unattended.

Danger of fire.

- f Do not park or operate the vehicle in areas where the hot exhaust system may come in contact with dry grass, brush, fuel spill or other flammable material.
- f If your car catches on fire for any reason, call the fire department.
Do not endanger your life by attempting to put out the fire.

Risk of burn injury when standing near or coming into contact with the exhaust pipe.

The exhaust pipe is hot when the vehicle is running and remains hot for some time after the vehicle is turned off.

- f To prevent injury, make a point of noting where your vehicle's exhaust pipe is, avoid placing your legs near the exhaust pipe, and closely supervise children around the vehicle when the exhaust pipe could be hot.
A hot exhaust pipe can cause serious burns.

Stopping Engine

- f Turn key back to position **3**.
- f Do not stop engine immediately after hard or extended driving.
Keep engine running at increased idle for about two minutes to prevent excessive heat build-up before turning off engine.
- f To avoid discharging the battery, always remove the ignition key from the ignition lock.
- f When leaving the car, always remove the ignition key and apply the handbrake. Engage 1st gear or reverse gear on vehicles with manual transmission or move the selector lever to position **P** on vehicles with PDK transmission.
- f Engage the steering lock by moving the steering wheel to the left or right.
Turn the steering wheel to the locking position before you switch off the engine so that you don't have to exert yourself when locking or unlocking the steering.

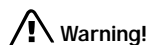

Danger of injury. Hot engine compartment components can burn skin on contact.

- f Before working on any part in the engine compartment, turn the engine off and let it cool down sufficiently.

Engine-compartment blower, radiator fan

The radiator and radiator fans are in the front of the car.

The engine-compartment blower is mounted on the engine compartment lid.

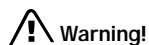

Risk of injury.

After the engine is switched off, the engine-compartment temperature is monitored for approx. 30 minutes.

During this period, and depending on temperature, the engine-compartment blower may continue to run or start to run.

- f Carry out work in these areas only with the engine off, the ignition off, and exercise extreme caution.

Risk of injury. The radiator fans in the front end of the car may be operating or unexpectedly start operating when the engine is switched on.

- f Carry out work in these areas only with the engine switched off.

Automatic garage door

The ignition system in your Porsche may interfere with your electronically operated garage door.

- f To check this, drive your Porsche close to the garage door. Make sure not to interfere with the operating range of the door.
- f Run the engine at different speeds.
- f If the garage door opens or closes without you operating the garage door unit in your car, contact the dealer who installed the automatic garage door to have the frequency and/or coding of the garage door signal changed or modified.



Emergency Flasher Switch

Operational readiness of the emergency flasher does not depend on the ignition lock and turn signal lever position.

- f If your car is disabled or parked under emergency conditions switch on the emergency flasher in the dashboard.
All turn signals and the indicator light in the switch flash with the same frequency.

Warning!

Risk of an accident, resulting in serious personal injury or death.

- f Whenever stalled or stopped for emergency repairs, move the car well off the road. Switch on the emergency flasher and mark the car with road flares or other warning devices.
- f Do not remain in the car. Someone approaching from the rear may not realize your vehicle is stopped and cause a collision.

Danger of fire.

- f Do not park or operate the vehicle in areas where the hot exhaust system may come in contact with dry grass, brush, fuel spill or other flammable material.

Hot engine compartment components can burn skin on contact.

- f Before working on any part in the engine compartment, turn the engine off and let it cool down sufficiently.



Light Switch

- **Lights switched off**

Daytime driving lights are switched on when the engine is running.

HOME Welcome Home Function

Daytime driving lights are switched on when the engine is running.

 **Parking lights**, side marker lights, license plate light, instrument illumination, daytime driving lights switched off

Low beam, high beam

Only with ignition on, daytime driving lights switched off

Rear fog light

Pull switch to second click. Indicator light on.

Warning chime

If the ignition key is withdrawn and the door is opened while the lights (not the parking light or Welcome Home lighting) are on, a **chime** warns of possible battery discharge.

In some countries, differences are possible due to provisions of law.

Daytime driving lights

The daytime driving lights are integrated in the front auxiliary headlights. These lights are switched on only when the engine is running and with the light switch in the positions OFF or HOME. Low beam headlights must be switched on when driving through tunnels or at dusk, for example.

Operation of the daytime driving lights may vary depending on country-specific regulations.

Canada only:

In addition to the auxiliary headlights the parking lights are switched on.

USA only:

The daytime driving lights can be deactivated in the on-board computer.

f Please see the chapter "ON-BOARD COMPUTER (BC)" on Page 126.

Vehicles with the Sport Chrono Package Plus

Further individual light functions (e.g. daytime driving lights) are available in vehicles with the Sport Chrono Package Plus.

f Please observe the chapter "Individual Memory" in the separate PCM operating instructions.

Cornering light

The dynamic cornering light is activated above speeds of 6 mph (10 km/h).

Welcome Home Lighting

Switching on

f Move light switch to the HOME position.

For improved visibility and security when you get in and out of the car, the daytime driving lights and the tail lights remain on for a certain period of time:

- **When you get out of the car**, the lights are turned on for approx. 30 seconds after the door is opened. The off-delay time resumes when the vehicle is locked.

On vehicles with the Sport Chrono Package Plus, the PCM can be used to set the off-delay time. This setting also changes the lighting period for unlocking the vehicle.

Please observe the chapter "Individual Memory" in the separate PCM operating instructions.

- The lights are turned on for approx. 30 seconds **when the vehicle is unlocked**. The lights go out if the ignition is switched on or when leaving the Welcome Home lighting.

Automatic Headlight Beam Adjustment

Vehicles with **Bi-Xenon headlights** feature **dynamic** headlight beam adjustment.

When the ignition is switched on, the level of the headlight beam automatically changes in accordance with the vehicle load.

The level of the headlight beam is automatically kept constant during acceleration and braking.

Checking operation

1. Switch the low beam on.
2. Insert ignition key and switch ignition on.
The light beam first dips all the way down and is then adapted to the vehicle load.

If this test item is not met, the headlight beam adjustment system must be checked by an authorized Porsche dealer.



Turn Signal / Headlight Dimmer / Parking light / Flasher Lever

Turn signals, low beam and high beam are ready for operation when the ignition is on.

1 – Turn signal left

2 – Turn signal right

Push the lever to the upper or lower pressure point – turn signals flash three times

3 – High beam

4 – Headlight flasher

Lever in center position – Low beam

When high beam and headlight flasher are selected, the blue indicator light in the tachometer is lit.

The turn signal lever turns off automatically when the steering wheel is straightened out after completing a turn.

Lane changer

- f To indicate your intention when changing lanes on the freeway, slightly lift or depress the lever to the resistance point. The lever will return to the OFF position when released.
- f If the frequency of the display becomes noticeably faster, check the operation of the turn signal bulbs.

Headlight flasher

(With ignition on or off)

- f To flash the headlights to oncoming motorists, slightly pull the lever toward the steering wheel and then release it. The blue indicator light in the tachometer will go on/off as you pull/release the lever.

Parking light

The parking light can only be switched on when the ignition is switched off.

- f Move the lever up or down to switch on the right or left parking light.

Individual Light Functions

Further individual light functions are available in vehicles with the Sport Chrono Plus package.

- f Please refer to the chapter “Individual Memory” in the separate PCM operating instructions.



Windshield Wiper / Washer Lever



Warning!

Danger of injury when the windshield wipers operate unintentionally, e.g. in intermittent or rain sensor operation.

Risk of damage to the windshield and wiper system.

- f Avoid running the wiper blades over a dry windshield to prevent scratching the glass. Spray washer fluid on the windshield first. A scratched windshield will reduce visibility.
- f Always loosen wiper blades from frozen glass before operating wipers to prevent damage to the wiper motor or blades.

- f Always switch off windshield wipers in car wash to prevent them wiping unintentionally (intermittent or sensor operation).
- f Always switch off windshield wipers before cleaning the windshield to avoid unintentional operation (intermittent or sensor operation).
- f Do not operate the headlight washer in car washes.
- f Do not operate headlight washer when it is frozen.

Front wiper and headlight washer system

0 – Windshield wipers off

1 – Rain sensor operation for front windshield wipers

- f Move wiper lever upwards to the first click. Please see the chapter "RAIN SENSOR" on Page 85.

2 – Windshield wipers slow

- f Move wiper lever upwards to the second click.

3 – Windshield wipers fast

- f Move wiper lever upwards to the third click.

4 – Front windshield wiper – one-touch operation:

- f Move wiper lever downwards. The front windshield wipers wipe once.

5 – Windshield wipers and washer system:

- f Pull wiper lever towards the steering wheel. The washer system sprays and wipes while the lever is pulled towards the steering wheel. When the wiper lever is released, a few drying wipes are executed.

A - Headlight washer:

The washer sprays only while low beam or high beam is switched on.

- f Briefly push button **A** to operate headlight washer system.

- f If heavily soiled, repeat wash.

The headlight washer system automatically sprays once for every ten times the front windshield washer system is operated.

Note

The **windshield washer nozzles** are heated when the ignition is on, as a precaution against freezing.



The rear wiper is automatically switched off when a speed of 130 mph (210 km/h) is exceeded. It is switched on again when the speed falls below 124 mph (200 km/h).

On vehicles with the Sport Chrono Package Plus, further rear wiper functions can be selected via the PCM.

- f Please observe the chapter "Individual Memory" in the separate PCM operating instructions.

Rear Wiper

6 – Rear window wiper – intermittent operation

- f Move wiper lever forwards to the first click. The rear window wiper wipes at preset intervals.



Rain sensor

The rain sensor on the windshield measures the amount of rainfall (snowfall too). Wiper speed is automatically adjusted accordingly.

Switching on

- f Move wiper lever upwards to the first click.

Switching off

- f Move wiper lever to position **0**.

The rain sensor remains switched off if the wiper lever is already in position **1** when the ignition is switched on.

To switch the rain sensor on again:

- f Move wiper lever to position **0** and then to position **1** or
- f Operate windshield washer system **5** or
- f Change the sensitivity of the rain sensor with four-stage switch **A**.

Switch-on is confirmed by one wipe of the windshield.

On vehicles with the Sport Chrono Package Plus, further rain sensor functions can be selected via the PCM.

- f Please see the chapter "Individual Memory" in the separate PCM operating instructions.

Changing the sensitivity of the rain sensor

Sensitivity can be set with switch **A** in 4 stages:

- f Adjust switch **A** upwards – high sensitivity.
The setting is confirmed by one wipe of the windshield.
- f Adjust switch **A** downwards – low sensitivity.

Maintenance note

- f Periodically clean the wiper blades with a window cleaner, especially after the vehicle has been washed in a car wash. We recommend Porsche window cleaner. If they are very dirty (e.g. with insect remains), they can be cleaned with a sponge or cloth.

If the wiper blades rub or squeak, this may be as a result of the following:

If the vehicle is washed in an automatic car wash, wax residues may be adhering to the windshield. These wax residues can only be removed by using a window cleaner concentrate.

- f Please see the chapter "WASHER FLUID" on Page 220.
- f Please contact your authorized Porsche dealer for further information.

The wiper blades may be damaged or worn.

- f Replace wiper blades as soon as possible.



- A - Automatic speed control readiness off/on
- 1 - +SPEED/SET (accelerate/store)
- 2 - -SPEED (decelerate)
- 3 - OFF (interrupt)
- 4 - RESUME

Automatic Speed Control

The automatic speed control maintains any selected speed between 15 mph and 145 mph (30 km/h and 240 km/h) without you having to use the accelerator pedal.

The automatic speed control is operated with the lever on the steering wheel.

Vehicles with PDK

Downshifts are carried out to help maintain the pre-selected speed (especially when driving downhill).

Warning!

Risk of an accident resulting in serious personal injury or death. A constant speed may not be safe in heavy traffic, or on winding or slippery roads.

With the speed control system engaged, the engine speed will not return to idle when removing the foot from the accelerator pedal.

- f Do not use the speed control when it may be unsafe to keep the car at a constant speed.
- f Observe all local and national speed limits.

Switch automatic speed control readiness on

- f Press button **A** on the automatic speed control lever.



This green indicator light in the speedometer now indicates readiness

Hold and store speed

- f Bring the car to the desired speed with the accelerator.
- f Then briefly push the operating lever forward (position **1**).

Accelerating (e.g. to overtake)

Option 1

- f Increase the speed as usual with the accelerator.
When you ease off the accelerator, the previously saved value is set again.

Option 2

- f Push operating lever forward (position **1**) until the desired speed is reached.
The speed reached is maintained and stored when the lever is released.

Option 3

- f Push lever slightly forwards (position **1**) (a maximum of 10 times).
The speed is increased by 1 mph (1.6 km/h), each time the lever is pushed forwards.

Note on operation

Speed control operation is automatically interrupted if the speed is increased by more than approx. 16 mph (25 km/h) for longer than 20 seconds.

Decelerating

Option 1

- f Pull operating lever towards the steering wheel (position **2**) until the desired speed is reached. The speed reached is maintained and stored when the lever is released.

Option 2

- f Briefly move lever towards the steering wheel (position **2**) (a maximum of 10 times). The speed is reduced by 1 mph (1.6 km/h), each time the lever is moved towards the steering wheel.

Vehicles with PDK

Downshifts are carried out to improve deceleration (especially when driving downhill).

Interrupting automatic speed control operation

- f Pull operating lever downwards briefly (position **3**) **or**
- f Operate brake or clutch pedal **or**
- f Switch PDK to selector lever position **N**.
- f Please see the chapter "PORSCHE DOPPEL-KUPPLUNG (PDK)" on Page 170.

The speed driven before the interruption remains stored in the memory.

Automatic speed control operation is interrupted automatically:

- If the set vehicle speed is exceeded by more than approx. 16 mph (25 km/h) for longer than 20 seconds.
- If the actual vehicle speed falls to approx. 37 mph (60 km/h) below the set vehicle speed for longer than 60 seconds (upward slopes).
- For PSM control operations.

Resuming the stored speed

- f Briefly push operating lever upwards (position **4**). The speed control accelerates/decelerates the vehicle to the stored speed.

The stored speed should only be recalled when traffic conditions and the road surface so permit.

Switching automatic speed control readiness off

- f Press button **A** on the automatic speed control lever. The green readiness light in the speedometer goes off.

Note

The stored speed value is cleared when the vehicle is parked and the ignition is switched off.

Important note

On upward or downward slopes, the set speed cannot always be maintained by the automatic speed control.

- f To obtain sufficient engine braking or a better engine-speed range, a lower gear needs to be selected.

Cupholder (holder for drink cans and cups)

- f Keep the cupholder closed while driving.

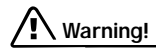

Warning!

Risk of scalding or damage due to spilling drinks.

- f Only use beverage containers which fit.
- f Never put overfull containers in the cupholder.
- f Never place hot drinks in the cupholder.



Extending cupholder

- f Press the panel.
The panel opens.



- f Press the symbol for the respective cupholder.
The cupholder extends out.

- f Close panel in the middle.

The cupholder diameter can be increased by pulling it out to hold larger containers.



Pulling cupholder out

- f Pull out holder (**arrow**).
- f Insert container.
- f Carefully slide holder inwards to adjust it to the container size.

Closing cupholder

- f Push cupholder drawer in.
- f Open panel in the middle.
- f Close and engage the cupholder.
- f Close panel in the middle.



Ashtray

Opening

- f Open ashtray lid.

Emptying

- f Open ashtray and carefully pull out ash insert.
- f Leave ashtray lid open.
Push in ash insert.

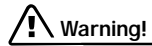

Danger of fire.

- f Never use ashtray for waste paper disposal, as it could pose a fire hazard.
-



Cigarette Lighter



Danger of fire and burning.

The cigarette lighter is ready for use, regardless of the ignition lock position.

- f Never leave unsupervised children in the car.
 - f Never touch the heating element or sides of the lighter.
 - f Hold the lighter by the knob only.
-

Heating lighter

- f Open ashtray lid.
- f Push in knob of the cigarette lighter.
When ready for use, the lighter will snap back.

Note on operation

The lighter receptacle is not to be used for electrical accessories (except for the tire filling compressor).

Maximum power consumption: 150 W

- f Please see the chapter "SOCKETS" on Page 257.

Storage in the Passenger Compartment

Warning!

Unsecured luggage and heavy objects may come loose during braking, rapid directional changes or in an accident and cause serious personal injury or death.

- f Do not transport any heavy objects in the storage trays.
- f Do not carry unsecured luggage or objects in the passenger compartment.

Additional storage possibilities

- in the doors,
- in the door sill next to the passenger's seat,
- in the center console,
- behind the rear seat backrests (only with the convertible top closed on the Cabriolet, when opening the convertible top there should not be any objects in the area behind the rear seats – **risk of damage**),
- storage tray with coin holder between seats,
- glove compartment with CD and pen holder,
- clothes hook on the roof frame,
- clothes hook on back of front backrests (depending on vehicle equipment),
- enlarged storage space by folding the rear seat backrests forward.

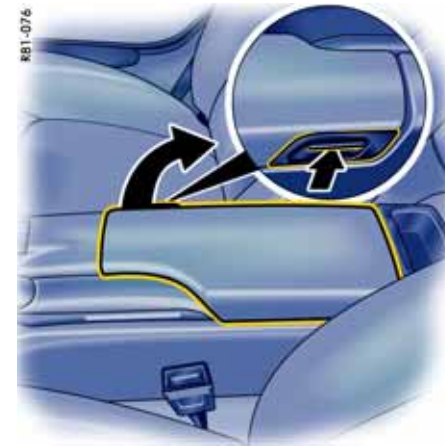

Storage tray between the seats

Opening

- f Press release button and lift the lid. There is a coin holder and socket in the forward part of the storage tray.
- f Please see the chapter "SOCKETS" on Page 257.

Glove compartment

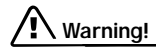

Warning!

Risk of injury by the glove compartment lid in case of an accident.

- f Keep the glove compartment closed while driving.



881-078

Opening

- f Pull the catch and open the lid.

Locking

- f Lock the catch to secure the contents against unauthorized access.



881-079

CD holder

Occupied drawers are indicated by a red window.

Opening drawers

- f Push the button of the drawer you wish to open.

Closing drawers

- f Fold up CD drawer and close until it engages.

Pen holder

A pen can be clipped in on the right side of the CD holder.



A - Opening luggage compartment lid
 B - Opening engine compartment lid

Luggage Compartment Lid and Engine Compartment Lid

Unlocking

- f Operate the appropriate pull-button next to the driver's seat.
 The luggage compartment or engine compartment is illuminated when the respective lid is open.
- f Please see the chapter "LOAD SWITCH-OFF AFTER 2 HOURS OR 7 DAYS" on Page 258.

The luggage compartment lid can also be unlocked with the radio remote control.

- f Please see the chapter "KEYS" on Page 15.

Important Note

If the vehicle battery is discharged, the luggage compartment lid can be opened only by connecting an external electrical power source.

- f Please see the chapter "ELECTRICAL SYSTEM" on Page 257.
 or the description inside the fuse box lid.



Warning message

A warning message in the on-board computer comes on if the lids are not completely closed.

- f Fully close the lid.



Opening luggage compartment lid

⚠ Caution!

Risk of damage to luggage compartment lid or windshield wipers.

- f Make sure that the windshield wipers are not folded out forwards when opening the luggage compartment lid.

- f Raise lid slightly and unlatch the safety catch with the red lever (**arrow**).

Closing luggage compartment lid and engine compartment lid

- f Lower the lid and close it.
- f Push the lid closed with the palm of your hand in the area of the lock.
Check that the lid has correctly engaged in the lock.

⚠ Warning!

Risk of loss of control or an accident, resulting in serious personal injury or death.

- f Should you notice at any time while driving that one of the lids is not secured properly, please stop immediately in a suitable place and close it.
The front lid may fly up impairing vision.

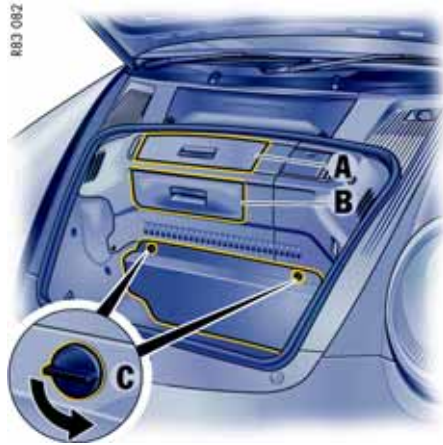

Luggage Compartment (Vehicles without Porsche Traction Management PTM)

Access covers A and B

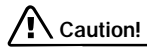

Caution!

Risk of injury or damage.

- f Do not store any objects behind the access covers **A** and **B**.



- E - Adapter for security wheel bolts
- F - Tire filling compressor
- G - Towing hook
- H - Tool kit
- I - Tire sealant

Tool box

Opening

- f Unlock turn-locks **C**.
- f Open tool box and place it on the floor of the luggage compartment.

Closing

- f Insert tool box into the guide pegs in the luggage compartment floor.
- f Close tool box and lock the turn-locks **C**.

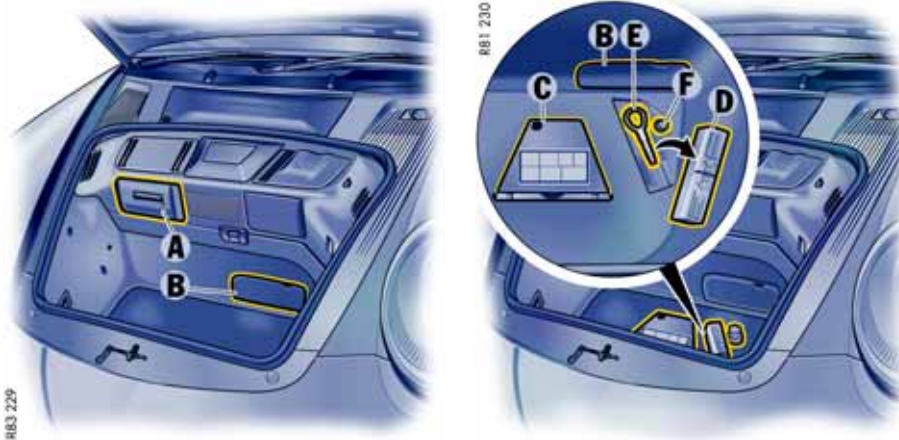

Luggage Compartment (Vehicles with Porsche Traction Management PTM)

Access cover A

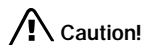

Caution!

Risk of injury or damage.

- f Do not store any objects behind the access cover **A**.

- B** - Access cover for tire sealant
- C** - Tire filling compressor
- D** - Tool kit
- E** - Towing lug
- F** - Adapter for security wheel bolts

Tire sealant

The tire sealant is located behind the access cover **B**.

- f Open access cover **B** using the opening.

Tools

The tools are located under the floor plate of the luggage compartment.

- f Lift the floor plate on the opening and take out.

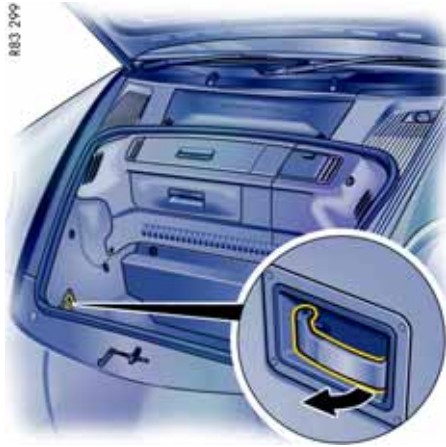

Trunk Entrapment

Your vehicle is equipped with an internal trunk release mechanism.

A person trapped in the luggage compartment can release the lid from the inside using the unlocking handle.

The handle is fluorescent and glows in the dark.

Note

- f When loading the luggage compartment, make sure that items of luggage or other objects cannot become caught on the handle. This could cause the luggage compartment to open unintentionally.

Warning light

A warning message in the on-board computer lights up when the unlocking handle is operated.

- f Stop the vehicle immediately when the warning lights light up.
- f Check the luggage compartment.
- f Close the lid.

Function with vehicle stationary

If the luggage compartment lid is unlocked with the unlocking handle, the lid can be opened from the inside immediately.

Function with vehicle in motion

If the luggage compartment lid is unlocked with the unlocking handle when a speed of 2 mph (3 km/h) is exceeded, the warning message in the on-board computer lights up.

At the same time, the lid is unlocked and the latch striker pops into the catch-hook position.

Danger!

Risk of accident.

If the warning message in the on-board computer lights up when the vehicle is in motion, the lid may impact in front of the windshield and can tear off.

You can lose control of the vehicle and serious personal injury or death may result.

- f Stop the vehicle immediately when the warning message lights up.
- f Check the luggage compartment.
- f Close the lid.

Note

The lid cannot be opened from the inside if the battery is disconnected or empty.

Safety reasons require that you unscrew the latch striker of the lid lock if you plan to put the vehicle out of operation for an extended period.

- f Please consult your authorized Porsche dealer. They will advise you about the necessary measures.

Porsche Communication Management (PCM)

- f Refer to the separate operating instructions before putting the PCM into operation.
- f Please see the chapter "LOAD SWITCH-OFF AFTER 2 HOURS OR 7 DAYS" on Page 258.

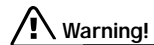

Warning!

There is a danger of accident if you set or operate the on-board computer, radio, navigation system, telephone or other equipment when driving.

This could distract you from the traffic and cause you to lose control of the vehicle resulting in serious personal injury or death.

- f Operate the components while driving only if the traffic situation allows you to do so safely.
- f Carry out any complicated operating or setting procedures only with the vehicle stationary.

The reception conditions for the radio module integrated in the PCM change continuously as you drive. Interference from buildings, terrain and the weather is unavoidable.

FM stereo reception is particularly susceptible to varying reception conditions.

Electronic accessories should only be retrofitted by your authorized Porsche dealer.

Accessories which have not been tested and approved by Porsche may impair radio function and reception.

Navigation

When put into operation for the first time, a distance of approx. 30 miles (50 km) must be driven in order for the navigation system to complete the process of fine calibration.

The same applies when the tires are changed (e.g. summer/snow tires) or new tires fitted.

Full location accuracy is not yet achieved during the fine-calibration process.

If the vehicle has been transported (e.g. ferry, car train), the system may take a few minutes to determine the current location after it has been switched on.

Serious tire slip (e.g. spinning wheels on snow) may result in temporarily inaccurate navigation.

When the battery has been disconnected, it may take up to 15 minutes before the navigation system is operational again.

Car Audio Operation/Tips

For radio operation see your radio manual which is included with your on-board literature.

- f Please see the chapter "LOAD SWITCH-OFF AFTER 2 HOURS OR 7 DAYS" on Page 258.

FM reception

A vehicle is not an ideal place to listen to a radio. Because the vehicle moves, reception conditions are constantly changing.

Buildings, terrain, signal distance and noise from other vehicles are all working against good reception.

Some conditions affecting FM may appear to be problems when they are not.

The following characteristics are completely normal for a given reception area, and they do not indicate any problem with the radio itself.

Note

Electronic accessories should only be installed by your authorized Porsche dealer.

Equipment which has not been tested and approved by Porsche may impair radio reception.

Fading and drifting

FM range is limited to about 25 miles (40 km), except for some high power stations.

If a vehicle is moving away from the desired station's transmitter, the signal will tend to fade and/or drift. This condition is more prevalent with FM than AM, and is often accompanied by distortion. Fading and drifting can be minimized to a certain degree by careful attention to fine tuning or selection of a stronger signal.

Static and fluttering

When the line-of-sight link between a transmitter and vehicle is blocked by large buildings or mountains, the radio sound may be accompanied with static or fluttering because of the characteristic of FM.

In a similar effect, a fluttering noise is sometimes heard when driving along a tree-lined road.

This static and fluttering can be reduced by adjusting the tone control for greater bass response until the disturbance has passed.

Multipath

Because of the reflecting characteristics of FM, direct and reflected signals may reach the antenna at the same time (multipath) and cancel each other out.

As a vehicle moves through these electronic dead spots, the listener may hear a momentary flutter or loss of reception.

Station swapping

When two FM stations are close to each other, and an electronic dead spot, such as static or multipath area, interrupts the original signal, sometimes the stronger second signal will be selected automatically until the original one returns.

This swapping can also occur as you drive away from the selected station and approach another station of a stronger signal.

Compact disc player



To avoid damage to compact disc player and discs.

- f Use only compact discs labeled as shown, having no dirt, damage or warpage.
- f Never attempt to disassemble or oil any part of the player unit.
Do not insert any object other than a disc into the slot.
Remember there are no user-serviceable parts inside the compact disc player.
- f Do not allow the disc to sustain any fingerprints, scrapes or stickers on the surfaces.
This may cause poor sound quality.
Hold the disc only on the edge or center hole.

- f When not in use, take the disc out of the player, put the disc back into its case and store it away from dust, heat, damp and direct sunlight.
Leaving the disc on the dashboard in the sun can damage the disc.
 - f If the disc gets dirty, clean the disc by wiping the surfaces from the center to the outside in a radial direction with a soft cloth.
Do not use a conventional record cleaner or anti-static record preservative.
Disc cleaners are available in audio stores.
-



Antenna

f Always unscrew the external antenna before using an automatic car-wash.

On the Cabriolet and Targa the external antenna is mounted on the right front fender.

Car Telephone and Aftermarket Alarms

Important legal and safety information regarding the use of cellular telephones

Some states may prohibit the use of cellular telephones while driving a vehicle. Check the laws and regulations on the use of cellular telephones in the areas where you drive.



Risk of an accident.
Severe personal injury or death can result in the event of an accident.
Looking away from the road or turning your attention away from your driving can cause an accident and serious or fatal injury.

When using your cellular telephone, you should always:

- f Give full attention to your driving - pull off the road and park before making or answering a call if traffic conditions so require; **and**
- f Keep both hands on the steering wheel - use hands-free operation (if available) - pull off the road and park before using a hand-held telephone.

It is essential to observe the telephone manufacturer's instructions before operating the telephone.

Any portable telephone or radio transmitter which is used in a Porsche must be properly installed in accordance with the technical requirements of Porsche.

The transmission power must not exceed 10 W.

The devices must possess a type approval for your vehicle and have an "e" symbol.

If you should require equipment with transmission power values greater than 10 W, please consult your authorized Porsche dealer for this purpose. The dealer is familiar with the technical requirements for installing devices of this kind.

The antennas for all radios and telephones with a transmitting antenna must be externally mounted.

The improper installation of radios or telephones or use of a radio or telephone with a transmitting antenna inside the car may cause **the warning lights to come on.**

Improper installation of such equipment can create a discharged battery or excessive current draw from added equipment.

If aftermarket systems are installed by non-dealer technicians or outside the selling dealer, problems may result. Installation of aftermarket equipment is not covered under the New Car Warranty.

- f Consult your authorized Porsche dealer about the installation of non Porsche approved equipment.

Reception quality

The reception quality of your car telephone will change constantly when you are driving. Interference caused by buildings, landscape and weather is unavoidable. It may become particularly difficult to hear when using the hands-free function due to external noise such as engine and wind noise.

Automatic car-wash

- f Unscrew external antennas before using an automatic car-wash.



iPod, USB and AUX

The interfaces for iPod, USB and AUX are located in the storage tray between the seats.

- f Please refer to the chapter "External Audio Source" in the separate PCM/CDR operating instructions.

Note

Do not leave an iPod, USB storage device or an external audio source in the vehicle for a prolonged period as extreme ambient conditions (temperature fluctuations, air humidity) can occur in the vehicle.

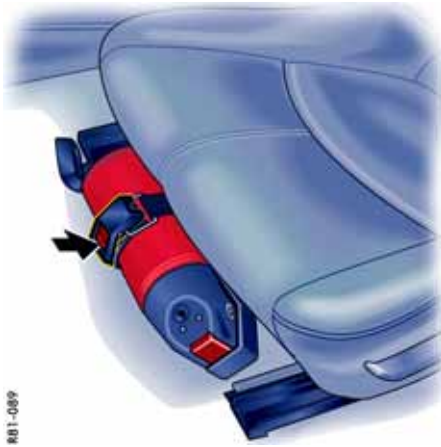

Fire Extinguisher

In cars equipped with a fire extinguisher, the extinguisher is fitted to the front of the driver's seat.

Taking out fire extinguisher

1. Hold fire extinguisher with one hand and press the PRESS button on the fastening strap with the other hand (**arrow**).
2. Remove fire extinguisher from mounting.



Inserting fire extinguisher

1. Place fire extinguisher in the mounting.
2. Engage fastening strap lug **A** in the tension jack and close tension jack (**arrow**).

Note

- f Pay attention to the final control date on the fire extinguisher.
If the fire extinguisher is used after its expiration date has elapsed, it may not operate properly.
- f Follow the operating instructions on the fire extinguisher.
- f The functional ability of the fire extinguisher should be checked by a specialist workshop every 1-2 years.
- f After use, have the fire extinguisher refilled.

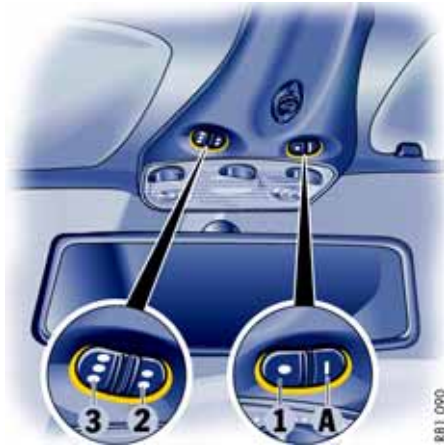

1, 2, 3 - Programmable buttons
A - Light-emitting diode for status identification

HomeLink

The programmable HomeLink replaces up to three original hand-held transmitters used to operate various devices (e.g. garage door, gate to the property, alarm system).

You can program buttons **1 to 3** with a frequency of an original handheld transmitter.

Warning!

Risk of accident when using the HomeLink if persons, animals or objects are within the range of movement of the equipment that is being operated.

- f When using the HomeLink, ensure that no persons, animals or objects are within the range of movement of the equipment that is being operated.
- f Observe the safety notes for the original hand-held transmitter.

Preconditions for operating and programming the HomeLink:

- The battery in the original hand-held transmitter must be new.
- Ignition is switched on.
- Daytime driving lights are switched off.

To operate the respective device:

- f Press the appropriate button (**1, 2 or 3**). Light-emitting diode **A** lights up during signal transfer.

Note on operation

- f Always use the HomeLink opener in the direction of travel. Otherwise, range restrictions cannot be ruled out.
- f Before selling the vehicle, delete the programmed signals of the HomeLink.
- f Please read the instructions for the original hand-held transmitter to find out whether the original transmitter is equipped with fixed or changeable code.
- f Always fit new batteries in your hand-held transmitter before programming the transmitter.

Allocating signals to the buttons

- f Please follow the operating instructions for the original hand-held transmitter.

Clearing factory settings prior to programming the HomeLink for the first time

The following process deletes the standard codes set at the factory. Do not repeat the process if you program further buttons.

- f Keep the two outer buttons **1 and 3** depressed for approx. 20 seconds until light-emitting diode **A** begins to flash quickly. All programmed signals of buttons **1 to 3** are deleted.



Programming HomeLink with fixed code hand-held transmitters

1. Press the desired button until the light-emitting diode begins to flash slowly. You then have approx. 5 minutes to perform steps 2 and 3.
2. Hold the original hand-held transmitter approx. 0 to 12 in. (0 to 30 cm) in front of the marked position (figure) on the vehicle.
3. Press the transmit button on the original hand-held transmitter until the daytime driving lights flash three times (up to approx. 45 seconds).
4. Repeat steps 1 to 3 to allocate other buttons.

Note

Programming HomeLink with changeable code hand-held transmitters

1. Press the desired button until the light-emitting diode begins to flash slowly. You then have approx. 5 minutes to perform steps 2 and 3.
2. Hold the original hand-held transmitter approx. 0 to 12 in. (0 to 30 cm) in front of the marked position (figure) on the vehicle.
3. Press the transmit button on the original hand-held transmitter until the daytime driving lights flash three times (up to approx. 45 seconds).
4. To synchronize the system: Press the programming button on the receiver for the garage door actuator. Afterwards, you usually have approx. 30 seconds to initiate step 5.
5. Press the allocated HomeLink button twice. (With some devices, the button to be allocated must be pressed a third time in order to complete the setting process.)
6. Repeat the programming steps to allocate other buttons.

Note

Several attempts with different distances between the vehicle and the original hand-held transmitter might be necessary.

The daytime driving lights will flash once the 5 minutes have been exceeded. Programming must be repeated from the beginning.

- f Please consult your authorized Porsche dealer if you have not been able to successfully allocate signals for the garage door opener to the buttons even though you have carefully followed the instructions in this chapter and the operating instructions for the original hand-held transmitter.

Deleting programmed signals of the HomeLink

(e.g., when selling the vehicle)

Keep the two outer buttons **1** and **3** depressed for approx. 20 seconds until light-emitting diode **A** begins to flash quickly. All programmed signals of buttons **1** to **3** are deleted.

Automatic Air Conditioning System, Heated Rear Window/Door Mirror Heating

Automatic Air Conditioning System	106
Central and Side Vents.....	109
Fresh-air Intake	109
Heated Rear Window/Door Mirror Heating ...	110

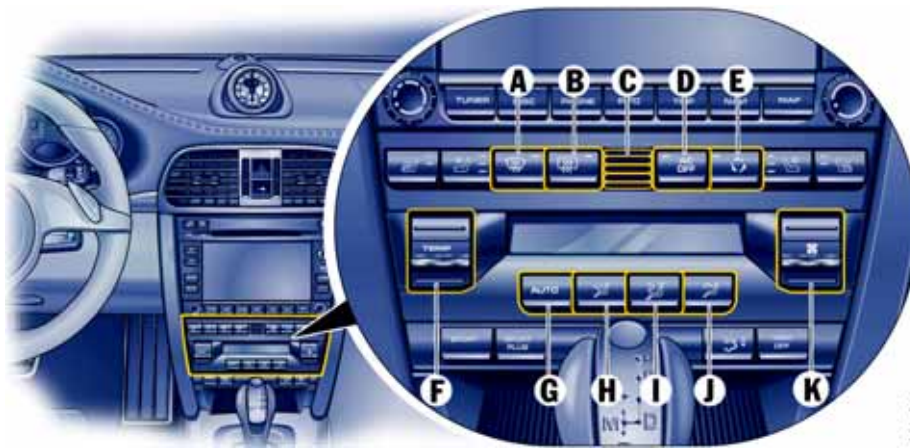

- A - Defrosting the windshield*
- B - Heated rear window*
- C - Temperature sensor*
- D - AC OFF button (air-conditioning compressor off/on)*
- E - Recirculating-air button*
- F - Temperature button*
- G - AUTO button (automatic mode)*
- H - Air distribution to footwell*
- I - Air distribution to central and side vents*
- J - Air distribution to windshield*
- K - Blower speed button*

Automatic Air Conditioning System Automatic mode

The automatic air-conditioning system controls the preselected interior temperature completely automatically.
If necessary, the automatic system can be manually adjusted.

- f Press AUTO button **G**.
AUTO will appear on the display panel.
Air quantity and distribution are automatically controlled and variations are compensated.
- All automatic setting functions can be individually changed.
This setting is retained until the appropriate function button is pressed again or the AUTO button is pressed.

Setting temperature

- f Press button **F** upwards or downwards respectively.

To suit personal comfort, the interior temperature can be adjusted between 61 °F and 85 °F/16 °C and 29.5 °C.

Recommendation: 72 °F/22 °C.

If "LO" or "HI" appears on the display, the system is operating at maximum cooling or heating power.

Automatic control is no longer active.

Note

If the preselected temperature is changed, the blower speed can increase automatically in automatic mode.

The desired temperature is reached more quickly this way.

Sensors

To avoid affecting the performance of the air-conditioning system:

- f Do not cover the sun sensor on the instrument panel or the temperature sensor **C**.



Defrosting the windshield

- f Press button **A** (switch on or off).
The windshield is defogged or defrosted as quickly as possible.
Air flows to the windshield only.
The light-emitting diode in the button lights up.

AC OFF – switching compressor for air-conditioning system on and off

The air-conditioning compressor switches off automatically at temperatures below approx. 37 °F/3 °C and cannot be switched on, even manually.

Whenever outside temperatures exceed approx. 37 °F/3 °C, the air-conditioning compressor is always switched on in automatic mode.

The compressor can be switched off to save fuel, but control comfort is then limited:

- f Press AC OFF button **D**.
The compressor is switched off.
The light-emitting diode in the button lights up.
- f If the interior temperature is too high, switch compressor back on or press AUTO button.

To dry incoming air in damp weather, do not switch off the air-conditioning compressor. This prevents fogging of windows.



Adjusting blower speed

- f Press button **K** upwards or downwards respectively.
The preset blower speed is increased or decreased.

The speed stages are indicated by a bar display.

If the button is pressed downwards at the lowest blower stage, the blower and automatic control are switched off. "OFF" will appear on the display field.

Pressing the button upwards or pressing the AUTO button switches the blower and automatic control back on again.



Recirculating-air setting



Warning!

Risk of accident due to impaired vision, resulting in serious personal injury or death. In recirculating-air setting, the windows may fog up.

- f Only select recirculating-air setting for short periods.
- f If the windows fog up, switch recirculating-air setting off immediately by pressing the circulating-air button again and select the "Defrost windshield" function.

Switching recirculating-air setting on or off

- f Press button E.
The outside-air supply is interrupted and only the inside air is circulated.
The light-emitting diode in the button lights up.

Over approx. 37 °F/3 °C

If the air-conditioning compressor was off, it switches on automatically. The duration of recirculating-air setting is not limited.

Below approx. 37 °F/3 °C

The air-conditioning compressor is switched off. Recirculating-air setting is automatically ended after approx. 3 minutes.

Air distribution

The individual air distributions can be combined as desired.

Recommended setting in Summer:
Air distribution to central and side vents.

Recommended setting in Winter:
Air distribution to footwell and windshield.



Air distribution to footwell

- f Press button H.
The air flows to the footwell.
The selection appears on the display panel.



Air distribution to central and side vents

- f Press button I.
The air flows from the central and side vents.
Vents must be open.
The selection appears on the display panel.



Air distribution to windshield

- f Press button J.
The air flows to the windshield.
The selection appears on the display panel.

Note on operation

- f On vehicles with the Sport Chrono Package Plus, individual air conditioning settings can be stored on your vehicle key.
Please observe the chapter "Individual Memory" in the separate PCM operating instructions.

General instructions for air-conditioning compressor

- Can switch off briefly if engine is under an extreme load to ensure sufficient engine cooling.
- Switches off automatically at temperatures below approx. 37 °F/3 °C and cannot be switched on, even manually.
- Operates most effectively with windows closed.
If the car has been in the sun for a long time, it is a good idea to ventilate the interior briefly with the windows open.
- Depending on the outside temperature and humidity, condensation can drip from the evaporator and form a pool under the vehicle.
This is normal and not a sign of leakage.
- If uncooled air flows out when the lowest temperature has been set, switch off the air-conditioning compressor and have the fault repaired at an authorized Porsche dealer.



A - Continuous opening and closing
B - Setting vent direction

Central and Side Vents

○ Opening vents

f Rotate knurled wheel upward.

● Closing vents

f Rotate knurled wheel downward.

Changing air flow direction

f Move the vanes to make the air flow in the desired direction.

Outside air or conditioned air can be delivered from all vents, depending on the air-distribution setting on the operating panel.

Fresh-air Intake

To ensure proper air intake:

f Keep the fresh-air inlet between the luggage compartment lid and the windshield free from snow, ice and leaves.



Switching on

- f Press button.
The light-emitting diode in the button lights up.

After approx. 15 minutes, the heating switches off automatically.
The heater can be switched back on by pressing the button again.

Switching off

- f Press button.
The light-emitting diode in the button goes out.



Heated Rear Window/Door Mirror Heating

The heated rear window/door mirror heating is ready for operation when the ignition is on.

110 Automatic air conditioning system, Heated rear window/Door mirror heating

Instruments, On-Board Computer, Warnings

Instrument Panel USA Models	112
Instrument Panel Canada Models	114
Engine Oil Temperature	116
Automatic Speed Control Indicator light	116
Instrument Illumination	116
Trip Odometer	117
Speedometer	118
Changing over between Miles / Kilometers..	118
Tachometer	119
Turn Signal Indicator Light	119
High Beam Indicator Light	119
Gear Shift Indicator "A" (in vehicles with manual transmission)	119
Cooling System	120
Porsche Doppelkupplung (PDK)	121
Fuel	122
Clock	123
Outside Temperature	123
Engine Oil Pressure	124
Check Engine (Emission Control)	125
On-Board Computer (BC)	126
Warnings on the instrument panel and the on-board computer	158

Instrument Panel USA Models

Also refer to the corresponding chapters in the Owner's Manual.

1. Engine oil temperature gage
2. Speedometer with analogue display
3. Tire pressure warning light
4. Turn signal indicator light, left
5. Tachometer
6. High beam indicator light
7. Turn signal indicator light, right
8. ABS warning light
9. Cooling system
Temperature gage, warning light
10. Fuel
Level gage, warning light
11. Engine oil pressure gage
12. Adjustment button for instrument illumination and trip counter
13. Odometer and daily trip mileage display
14. Automatic speed control indicator light
15. Light sensor for instrument illumination
16. Airbag warning light
17. Check Engine warning light
(Emission control warning light)
18. Central warning light
19. On-board computer display
20. Porsche Stability Management
PSM Multifunctional light
21. Brake warning light
22. Safety belt warning light
23. PDK transmission, gear display
24. PDK transmission, selector lever position
25. Clock and outside temperature display
26. Adjustment button for clock

When the ignition is switched on, the warning lights light up for a lamp check.

Note

Warnings that have been given are stored in the appropriate control unit memory and can be read out at an authorized Porsche dealer.

This information can help to warn you about situations which may be hazardous to you or your car.



Instrument Panel Canada Models

Also refer to the corresponding chapters in the Owner's Manual.

1. Engine oil temperature gage
2. Speedometer with analogue display
3. Tire pressure warning light
4. Turn signal indicator light, left
5. Tachometer
6. High beam indicator light
7. Turn signal indicator light, right
8. ABS warning light
9. Cooling system
Temperature gage, warning light
10. Fuel
Level gage, warning light
11. Engine oil pressure gage
12. Adjustment button for instrument illumination and trip counter
13. Odometer and daily trip mileage display
14. Automatic speed control indicator light
15. Light sensor for instrument illumination
16. Airbag warning light
17. Check Engine warning light
(Emission control warning light)
18. Central warning light
19. On-board computer display
20. Porsche Stability Management
PSM Multifunctional light
21. Brake warning light
22. Safety belt warning light
23. PDK transmission, gear display
24. PDK transmission, selector lever position
25. Clock and outside temperature display
26. Adjustment button for clock

When the ignition is switched on, the warning lights light up for a lamp check.

Note

Warnings that have been given are stored in the appropriate control unit memory and can be read out at an authorized Porsche dealer.

This information can help to warn you about situations which may be hazardous to you or your car.





Engine Oil Temperature

The engine oil temperature is indicated in the left instrument.



A - Adjustment button for instrument illumination and trip counter

Automatic Speed Control Indicator light

Indicates automatic speed control readiness.

Instrument Illumination

The illumination is automatically adjusted to the ambient brightness by the light sensor in the tachometer.

In addition, when the car lights are switched on, the instrument and switch symbol brightness can be manually adjusted.

Warning!

Risk of loss of control or accident, resulting in serious personal injury or death.

f Do not reach through the steering-wheel spokes while driving.

Note

When the car lights are switched on, the instrument lighting for light dials switches on and off automatically depending on the ambient brightness.



Dimming instrument illumination

- f Turn adjustment button **A** in the appropriate direction and hold it until the desired brightness has been reached.

The chosen level of brightness is indicated by a bar display in the display field of the on-board computer.



Trip Odometer

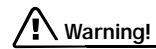

Warning!

Risk of loss of control or accident, resulting in serious personal injury or death.

- f Do not reach through the steering-wheel spokes while driving.

Resetting to zero

- f Press adjustment button **A** for approximately one second **or**
- f Reset the distance in the "SET" menu of the on-board computer.
Please see the chapter "SET BASIC SETTING ON ON-BOARD COMPUTER" on Page 155.

After exceeding 6,213 miles or 9,999 kilometers, the counter returns to "0".



Speedometer

The digital speedometer is integrated in the on-board computer.
The indication changes from mph to km/h when the units are changed from miles to kilometers.

Changing over between Miles / Kilometers

The units of the distance and speed displays can be changed in the "SET" menu of the on-board computer.

f Please see the chapter "SET BASIC SETTING ON ON-BOARD COMPUTER" on Page 155.



883-049

⚠ Caution!

To avoid severe engine damage.

- f Always observe the engine rpm before downshifting to a lower gear, so you do not exceed the maximum engine rpm.

↔ Turn Signal Indicator Light

Flashes in synchronism with the turn signals.

Left arrow – left turn signals
Right arrow – right turn signals

- f If the frequency of the display becomes noticeably faster, check the operation of the turn signals.

Tachometer

The tachometer shows the engine speed in revolutions per minute (rpm).

The beginning of the red marks at the right end of the scale indicates the maximum permissible engine rpm.

A speed limiter prevents the engine from being overrevved during acceleration. Before reaching this area, the next **higher** gear should be selected.

Shift to the next **lower** gear when the engine rpm drops below 1,500 rpm.

ⓘ High Beam Indicator Light

Lights when high beam or headlight flasher is switched on.

The indicator light goes out when the high beams are switched off.

The indicator light flashes in the event of cornering light failure.



883-500

Gear Shift Indicator "A" (in vehicles with manual transmission)

The consumption-orientated gear shift indicator **A** on the display panel of the on-board computer assists a fuel-saving driving style. The gear shift indicator lights up as a recommendation to shift up to the next-higher gear depending on the selected gear, engine rpm and accelerator pedal position.

- f When the gear shift indicator **A** lights up, change to the next higher gear to decrease fuel consumption.



883-050

Cooling System

Temperature gage (ignition on)

USA: Display in °F
Canada: Display in °C

Pointer to the left – engine cold

- f Avoid high engine speeds and heavy engine loading.

Pointer in the middle – normal operating temperature

The pointer may move up to the red area when engine is heavily loaded and outside temperature is high, but should return to “normal” when engine load is reduced.

Warning light “A”

If the **coolant temperature** is too high, the warning light **comes on**. Additionally, a warning is displayed in the on-board computer.

- f Pull off the road, turn off the engine and allow to cool.
- f Check radiator and air passages in front end of car for obstructions.
- f Check coolant level.
If necessary, add coolant and have fault remedied at an authorized Porsche dealer.
Please see the chapter “COOLANT LEVEL” on Page 207.

Note

To prevent excessive temperatures, the cooling-air passages must not be restricted by coverings (e.g. films, “stone guards”).

If the **coolant level** is too low, the warning light **flashes**.

Additionally, a warning is displayed in the on-board computer.

- f Switch engine off and allow to cool.
- f Add coolant after the engine has cooled to the touch.
- f Have the cause of the fault remedied at an authorized Porsche dealer.
Please see the chapter “COOLANT LEVEL” on Page 207.

Caution!

Risk of engine damage.

- f If the warning lights come on even though coolant level is correct, do not continue driving.
- f Have the fault remedied at the nearest authorized Porsche dealer.

Engine compartment blower fan

In addition, this warning light **flashes** to indicate a fault in the **engine compartment blower fan**.

- f Have the cause of the fault remedied at an authorized Porsche dealer.

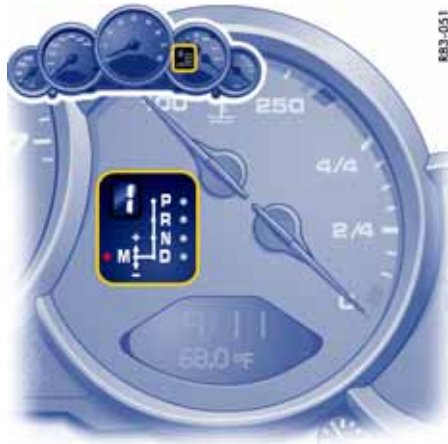

Porsche Doppelkupplung (PDK)

Indicator for PDK selector lever position and engaged gear

When the engine is running, the selector lever position and the engaged forward gear are indicated in gates **D** or **M**.

Warning messages

If the selector lever is between two positions

- Effects:
The corresponding selector lever position flashes on the instrument cluster **and** the warning "Selector lever not engaged" appears on the on-board computer.
- Remedy:
Operate the footbrake and engage the selector lever properly.

If there is a fault in the transmission

- Depending on priority, the warning "Transmission emergency run" in white or red lettering or the warning "Transmission temperature too high" is displayed on the on-board computer.

Warning "Transmission emergency run" **white**

- f Effects:
Restricted gearshift comfort,
Failure of reverse gear.
- Remedy:
Have the fault repaired immediately at an authorized Porsche dealer.

Warning "Transmission emergency run" **red**

- Effect:
Vehicle can be driven only until it comes to a stop.
- Remedy:
It is not possible to continue driving. Immediately stop the vehicle in a suitable place. Have the vehicle towed to an authorized Porsche dealer.

Warning "Transmission temperature too high"

- Effects:
"Warning jerks" can be felt when driving off and the engine power may be restricted.
- Remedies:
Do not hold the vehicle with the accelerator on a hill, for example. Hold the vehicle with the brake. Reduce engine load. If possible, stop the vehicle in a suitable place. Allow the engine to run in selector lever position **P** or **N** until the warning disappears.
- f Please see the chapter "REDUCED DRIVING PROGRAM" on Page 176.
- f Please see the chapter "PORSCHE DOPPELKUPPLUNG (PDK)" on Page 170.



Fuel

Level gage

When the ignition is on the fuel level is displayed.

f Please see the chapter "CAPACITIES" on Page 290.

If the vehicle's inclination changes (e.g. going up or downhill), minor deviations in the indication may occur.

Note

If a small quantity of fuel is added to a nearly empty fuel tank, the fuel gage cannot measure the added fuel accurately. The „remaining range" readout will also be incorrect.

Warning light "A"

When the engine is running, the warning light of the level gage lights up if less than approx. 2.6 U.S. gallons (10 liters) of fuel remains in the tank. Additionally, a warning is displayed in the on-board computer.

f Fill up at the next opportunity.

Caution!

To prevent damage to the emission control system and engine.

- f Never drive the tank completely out of fuel.
 - f Avoid high cornering speeds after the warning lights have come on.
-
- f Please see the chapter "EMISSION CONTROL SYSTEM" on Page 218.

If the level gage warning light flashes, there has been a system fault. Additionally, a warning is displayed in the on-board computer. There will then be no reserve warning.

f To remedy the fault, go to an authorized Porsche dealer.

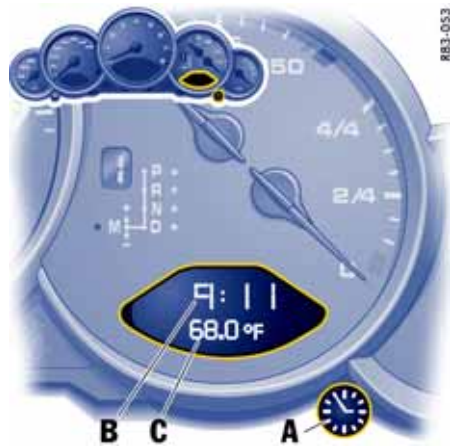

A - Adjustment button for clock
 B - Clock
 C - Outside temperature display

Clock

The **clock** is blanked out approximately four minutes after the ignition is switched off or when the car is locked.

Setting the time

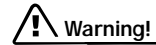

Warning!

Risk of loss of control or accident, resulting in serious personal injury or death.

f Do not reach through the steering-wheel spokes while driving.

f Switch ignition on.

Setting hours

f Press adjustment button **A** for about one second.
 Hour display flashes.

f Turn button in the appropriate direction:
 to right – increase hours figure
 to left – decrease hours figure.

Adjustment in hours – turn button briefly
 Fast adjustment (display cycles) –
 turn and hold button.

Setting minutes

f Press adjustment button again.
 Minutes display flashes.

f Set by rotating as in hours mode.

Leaving adjustment mode

Automatically after one minute **or**:

f Press adjustment button again.

When adjustment mode is deliberately left by pressing the button, the time begins precisely to the second.

Note

The time mode can be changed between 12h and 24h in the on-board computer.

Outside Temperature

The outside temperature display **C** does not indicate, if ice is on the road.

Even if a temperature above 32 °F (0 °C) is displayed, ice may still form on the road, for instance on bridges or when the road passes through a heavily shaded area.



Engine Oil Pressure

The oil pressure is controlled as required and should be at least 3.5 bar at an engine speed of 5000 rpm.

The engine oil pressure varies depending on the engine speed, engine load and engine temperature.

If oil pressure drops abruptly and a message is displayed on the on-board computer when the engine is running on or when driving:

- f Stop immediately in a suitable place.
- f Switch off the engine.
- f Check whether there is an obvious oil leak on or under the car.
- f If no oil leak can be detected: With the engine idling, measure the oil level with the on-board computer.
- f Please see the chapter "OIL DISPLAY AND MEASUREMENT OF THE ENGINE OIL LEVEL" on Page 153.
- f Please see the chapter "ENGINE OIL LEVEL" on Page 208.
- f Add engine oil if necessary.

Caution!

Risk of engine damage.

- f Do not continue driving if there is an obvious oil leak.
- f Do not continue driving if the warning lights come on even though oil level is correct.
- f Have the fault remedied at the nearest authorized Porsche dealer.

Battery

If the battery voltage drops abruptly, a warning message will be displayed by the on-board computer.

If the warning is displayed by the on-board computer while the engine is running or while driving:

- f Stop the car in a safe place and stop the engine.

Possible causes

- Defect in the battery charging system.
- Broken drive belt.

Warning!

Risk of engine damage with resultant loss of control and accident, leading to serious personal injury or death.

A broken drive belt means there is no power assistance to the steering (more effort is required to steer) and coolant pump function will stop.

- f Do not continue driving.
- f Have the fault remedied at the nearest authorized Porsche dealer.

Check Engine (Emission Control)

Warning Light

The emission control system detects malfunctions early that could, for example, cause increased pollutant emissions or consequential damage. Faults are indicated by a continuously lit or flashing instrument panel warning light. The faults are recorded in the control unit's fault memory.

The warning light in the instrument panel lights up when the ignition is switched on as a bulb check and goes out approx. 4 seconds after the engine starts. If the warning light does not light up, have the bulb replaced promptly.

The warning light in the instrument panel flashes to indicate operating states (e.g. engine misfiring) which might cause damage to certain parts of the emission control system.

- f In this case, immediately reduce the engine load by easing off the accelerator.
- f In order to avoid consequential damage to the engine or emission control system (e.g. catalytic converter), have the fault diagnosed and rectified immediately at the nearest authorized Porsche dealer.

If the warning light in the instrument panel lights up permanently without flashing before and remains on while driving, it suggests:

- a potential engine control problem and the need for system service **or**
- an improperly fastened tank cap **or**
- the vehicle was refueled while the engine was running.
- f Stop immediately at a suitable and secure place and check tank cap for proper fastening. If tank cap was fastened correctly, see your authorized Porsche dealer for service as soon as possible.

Caution!

If the check engine warning light in the instrument panel is flashing, serious catalytic converter damage and power loss will soon occur.

Prolonged driving with the check engine warning light on could cause damage to the emission control system. It also could affect fuel economy and driveability.

- f Have the fault remedied at the nearest authorized Porsche dealer immediately.

Central Warning Light

The central warning light on the instrument panel lights up if there are warning messages in the INFO menu.

The messages can be called in the on-board computer INFO menu:

- f Please see the chapter "INFO WARNING MESSAGES" on Page 132.

Brake Warning Light USA Brake Warning Light Canada

The warning light on the instrument panel lights up:

- if the handbrake is on,
- if the brake fluid level is low,
- if the brake pads have reached the wear limit,
- if the brake circuit division is defective.

Additionally, a warning is displayed by the on-board computer.

- f Please see the chapter "WARNINGS ON THE INSTRUMENT PANEL AND THE ON-BOARD COMPUTER" on Page 158.



RB2-055



RB1-056

On-Board Computer (BC)

Display field

The display field is beneath the tachometer.

Readiness for operation

- With ignition switched on,
- with engine running.

Operation, controls

It is not possible to describe all details of the on-board computer functions in this Owner's Manual. However, the examples will quickly familiarize you with the operational principle and help you to navigate through the menu structure.

You can restore the factory default settings at any time by using the "SET" menu.

Operating lever

The on-board computer is operated with the lower left lever on the steering column.

Selecting functions of the on-board computer

- f Push lever up **3** or down **4**.

Confirming selection (Enter)

- f Push the lever forward **1**.

Moving back one or several selection levels

- f Pull the lever back **2** once or several times **or**
- f  Select the arrow on the on-board computer display with the operating lever and push the operating lever forward **1**.

Note

You can always return to the basic menu by pulling the operating lever several times.

5 - Button for voice control

- f Please refer to the separate operating instructions for Porsche Communication Management (PCM).



A - Digital speedometer
 B - Central display
 C - Bottom display

Functions and display possibilities

Note

The available items and displays in the on-board computer depend on the equipment of your vehicle. For this reason it is possible that some of the items and displays shown here are not available in your on-board computer.

Basic setting

- Central display: Radio station

The central line **B** of the on-board computer can be selected in the SET menu.

Calling on-board computer functions in display "C"

- f Push operating lever up or down (selection field **D** must be switched off).

The following displays can be called step by step:

- Average speed (Ø mph),
- Average consumption (Ø mpg),
- Range on remaining fuel (mls → ) ,
- Tire pressure
- Navigation information (if activated in the SET menu).

Note

The values "Average speed", "Average consumption" and "Daily trip mileage" can be reset to zero in the SET menu.

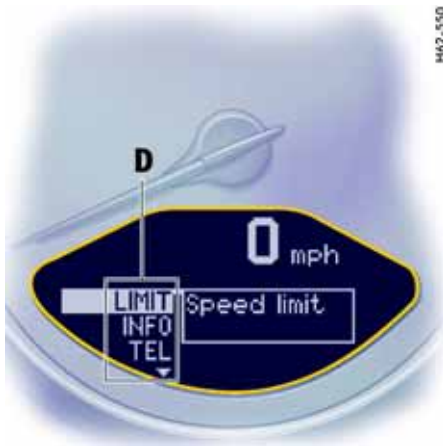

D - Switching selection field "D" on or off

f Push operating lever forward or back.



E - Arrow symbol for continuation

Arrow symbol: ▼

f Push operating lever down in order to page through the menu.

Arrow symbol: ▲

f Push operating lever up in order to page through the menu.



The following menus are available, depending on vehicle equipment:

1. LIMIT
2. INFO
3. TEL
4. CHRONO
5. AUDIO
6. NAVI
7. OIL
8. TPM
9. SET

LIMIT Acoustic warning signal for speed limit

The acoustic warning signal can be activated for speeds above 6 mph (10 km/h).

The signal sounds when the preset speed is exceeded.

For the signal to sound again, the driving speed must fall below the preset speed by at least 3 mph (5 km/h).

Switching on selection field "D"

f Push operating lever forward.

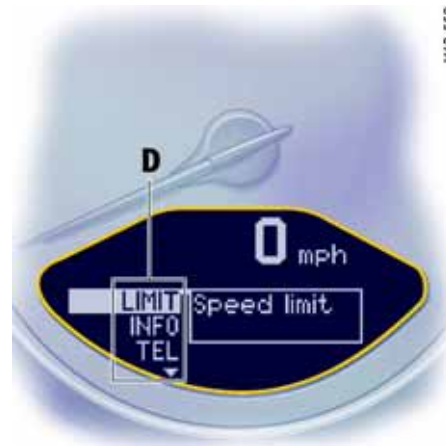

Setting the speed

f Select LIMIT with the operating lever.



f Push operating lever forward.



H62-509

**Option 1:
Accepting current speed**

- f Push operating lever forward.

The acoustic warning signal is activated for the current speed.

Display:

If the vehicle is stationary, the message "Cannot be accepted with car stopped" is displayed.



H62-512

**Option 2:
Presetting speed**

- f Select "LIMIT active" with the operating lever:

- not active
- active

- f If "not active", push the operating lever forward.



H62-511

- f Select "xx mph" with the operating lever.
- f Push operating lever forward.



Switching the acoustic warning signal off

- f Select "LIMIT active" with the operating lever.
- f Push operating lever forward.

Display:

- f Push operating lever slightly up or down until the desired speed is reached.

upwards: speed is increased
downwards: speed is decreased

Note

Holding the lever up or down for a longer period will adjust the speed in steps of 6 mph (10 km/h).

- f Push operating lever forward.



INFO
Warning messages

Switching on selection field "D"

- f Push operating lever forward.

Calling warning messages

- f Select INFO with the operating lever.



- f Push operating lever forward.
- f Select "Messages" with the operating lever.
- f Push operating lever forward.

Any existing warning messages can be called using the operating lever.
You also can call warning messages which were cancelled during the journey (but only until the next time the ignition is switched on).



- f Push operating lever forward.
- f Push operating lever forwards or pull backwards.
The display returns to the Info menu.



883-503

Service

Switching on selection field "D"

- f Push operating lever forward.

Recalling service information

- f Select INFO with the operating lever.
- f Push operating lever forward.
- f Select "Service" with the operating lever.
- f Push operating lever forward.
- f The time until the next service is displayed in miles and days.



1162-504

TEL Telephone information

Switching on selection field "D"

- f Push operating lever forward.

Recalling telephone information

- f Select TEL with the operating lever.



1162-560

- f Push operating lever forward.



M62-565

Note

You can recall phone calls, e.g. calls that arrived during your absence, via the menu item "Missed calls".



M62-561

Example:

Selecting from the telephone book and calling

- f Select "Phone book" with the operating lever.



M62-566

- f Push operating lever forward.
- f Select a person to call and push the operating lever forward. The connection is established.



- f Push the operating lever forward to end the call.



Incoming call

- f Select "Accept" or "Refuse" and push the operating lever forward.

Note

Rejected phone calls can be recalled with the menu item "Missed calls".



CHRONO Stopwatch

You can use the stopwatch to measure time intervals, e.g. on the race circuit or on work-related journeys. Measured lap times can be stored and evaluated if the vehicle is equipped with Porsche Communication Management (PCM).

f Please observe the chapter "Sport display" in the separate PCM operating instructions.

Stopwatch on the instrument panel

The stopwatch has an analogue and a digital display.

The large pointer of the analogue display measures the seconds. The two small pointers measure hours and minutes. The display re-starts at zero after 12 hours.

Seconds and increments of 1/100th of a second can be read on the digital display.

The digital display and the display in the on-board computer can indicate up to 99 hours and 59 minutes.

The stopwatch can be swivelled both to the left and to the right.

Stopwatch displays:

- on the stopwatch on the instrument panel,
- in the on-board computer menu CHRONO,
- on the performance display in the PCM.

Starting/stopping stopwatch

All stopwatch displays are started and stopped via the on-board computer menu CHRONO.

Note on operation

When you leave the CHRONO menu while the stopwatch is running, measurement will continue.

The stopwatch stops after the ignition is switched off. If the ignition is switched on again within approx. 4 minutes, the stopwatch will continue to run.

The only way to reset the stopwatch to zero is by selecting "Reset" in the CHRONO menu.



Starting the timing

- f Push operating lever forward.
The selection field is switched on.
- f Select CHRONO with the operating lever.



- f Push operating lever forward.



- f Push operating lever forward.
The time runs on all stopwatch displays.
The on-board computer display changes to the "Stop timing/Intermediate time" selection.



H62-538

Stopping the timing

After time measurement is started, the on-board computer display changes to the "Stop timing/Intermediate time".

f Select "Stop timing" with the operating lever.



H62-543

f Push lever forward.

The time is stopped in all stopwatch displays, and the on-board computer display changes to the "Continue/Reset" selection.

The timing can be continued or reset to zero.



H62-543

Continue timing

After timing has been stopped, the on-board computer display changes to the "Continue/Reset" selection.



H62-545

- f Push operating lever forward.
The stopwatch displays continue the timing.
- The on-board computer display returns to the "Stop timing/Intermediate time" selection. You can stop the stopwatch or measure an intermediate time.



H62-540

- Resetting the time**
- After timing has been stopped, the on-board computer display changes to the "Continue/Reset" selection.
- f Select "Reset" with the operating lever.



H62-515

- f Push operating lever forward.
The display returns to the "Start timing" selection.
The stopwatch displays in the instrument panel and the on-board computer are reset to zero.

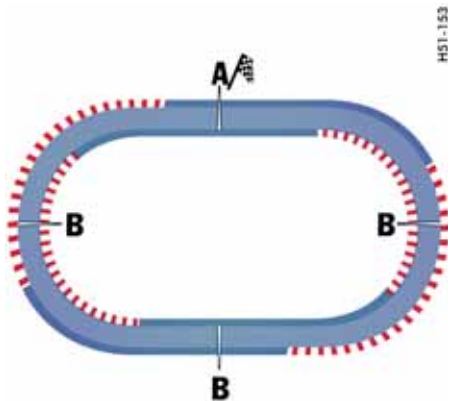

H5T-153

A - Lap
B - Intermediate time

Displaying intermediate times

Several intermediate times can be displayed for a route or for a lap on the race circuit. The intermediate times **B** are for your information. Measured lap times **A** can be stored and evaluated if the vehicle is equipped with Porsche Communication Management (PCM).



H62-539

After timing has been started, the on-board computer display changes to the "Stop timing/Intermediate time" selection.



H62-516

f Select "Intermediate time" with the operating lever and push the operating lever forwards.

The intermediate time will be displayed for approx. 5 seconds.



H62-539



H62-516



H62-541

The on-board computer display then returns to the "Stop timing/Intermediate time" selection.

- f You can stop the stopwatch or measure another intermediate time.

In order to start timing a new lap:

The "New lap?" selection appears for 5 seconds after selection of "Intermediate time".

- f Select "New lap?" with the operating lever and push the operating lever forwards.

The new lap is displayed on the on-board computer and the PCM. Timing on the on-board computer and on the PCM begins from zero. The stopwatch in the instrument panel continues to show the total time.



#62-339

- f The on-board computer display returns to the "Stop timing/Intermediate time" selection after a short period.
- f You can stop the stopwatch or measure another intermediate time or a new lap.



#83-505

AUDIO

Switching on selection field "D"

- f Push operating lever forward.

Selecting a radio station

- f Select "AUDIO" with the operating lever.
- f Push operating lever forward.
- f Select the desired station.
- f Push the operating lever up or down.



#83-506

NAVI

Switching on selection field "D"

- f Push operating lever forward.

Select destination

- f Select "NAVI" with the operating lever.
- f Push operating lever forward.
- f Select the desired function with the operating lever:
 - Last destinations
 - Destination memory
 - Route guidance



TPM Tire Pressure Monitoring

f Please see the chapter "TIRE PRESSURES FOR COLD TIRES (68 °F / 20 °C)" on Page 289.

The Tire Pressure Monitoring continuously monitors tire pressure and tire temperature on all four wheels and warns the driver when the tire pressure is too low.

The display as well as the settings for the Tire Pressure Monitoring take place on the on-board computer. However, you must still adjust the tire pressure on the wheel.

f The driver is responsible for filling the tires correctly and making the correct settings on the on-board computer.

The Tire Pressure Monitoring offers the following functions:

- Display of the actual tire pressure while the vehicle is in motion.
- Display of the deviation from the required pressure (refilling pressure).
- Display of currently set tire size and type.
- Tire pressure warnings in two stages.

Warning!

f Despite the advantages offered by the Tire Pressure Monitoring, it is still the driver's responsibility to update the corresponding settings in the on-board computer and maintain the pressure in the tires.

Low tire pressure reduces the road safety of the vehicle and destroys the tire and wheel.

f When a flat tire has been displayed, immediately stop in a suitable place and check the tires for damage. If necessary, remedy the damage with a tire sealant.

f Do not by any means continue to drive with damaged tires.

f Sealing the tire with tire sealant is only an emergency repair, so you can drive to the next authorized Porsche dealer. The maximum permitted speed is **50 mph (80 km/h)**.

f Do not drive with tires whose tire pressure drops again in a short period of time. In cases of doubt, have tires checked by an authorized Porsche dealer.

f Damaged tires must be immediately replaced by an authorized Porsche dealer.
Tire repairs are not permissible under any circumstances.

f If a fault occurs in the Tire Pressure Monitoring (e.g. defective wheel transmitter), contact an authorized Porsche dealer immediately and have the damage repaired.

The tire pressure will not be monitored at all or will be monitored only partially by defective Tire Pressure Monitoring.

f Tires lose air over time without a tire defect being present. A tire pressure warning will then appear in the on-board computer display. Correct the tire pressure at the next opportunity.

f The Tire Pressure Monitoring gives a warning about tire damage due to natural pressure loss as well as about a gradual loss of pressure due to foreign objects.

The Tire Pressure Monitoring cannot warn you about tire damage that occurs suddenly (e.g. flat tire due to abrupt external effects).



H63-519

Tire pressure function of the on-board computer

The tire pressure function of the on-board computer displays the tire pressures (actual pressure) dependent on temperature in the four wheels.

You can watch the tire pressure rise as the temperature increases while driving.

This display is only for information.

- f Under no circumstances should the tire pressures be changed based on this display.

Warning!

This display is for informational purposes only. Under no circumstances should the tire pressures be changed based on this display. Changing the tire pressure to incorrect pressures could adversely affect the performance, driving characteristics, and safety of your vehicle.

- f Maintain tire pressures according to the units indicated on the tire pressure plate, located on the drivers side door of the vehicle.

Displaying the tire pressure function of the on-board computer

- f Push operating lever up or down until the tire pressure function of the on-board computer appears.
(The selection field must be **switched off**.)



H93-519

Pressure info in tire pressure menu

In accordance with physical principles, the air pressure changes as the temperature changes. The tire pressure increases or decreases by around 1.5 psi (0.1 bar) for every 18 °F (10 °C) change in temperature.

The Tire Pressure Monitoring takes this relationship between tire pressure and temperature into account.

- f Please see the chapter "PRESSURE INCREASE AS THE RESULT OF TEMPERATURE INCREASE" on Page 152.

You can read the tire pressures to be corrected in this display.

The tire pressure to be corrected (refill pressure) is indicated on the displayed wheel.
 Example: If " -1.5 psi (-0.1 bar)" is displayed, 1.5 psi (0.1 bar) must be added to this tire.

Note

The tire pressure menu can only be called up when the vehicle is stationary.

Calling up the "Info pressure" display

- f Push operating lever forward in order to switch on the selection field.
- f Select "TPM" with the operating lever.
- f Push operating lever forward.
The display changes to the tire pressure menu.
- f Select "Info pressure" with the operating lever.
- f Push operating lever forward.

Note

After the ignition is switched on, it can take up to approx. 1 minute before all tire pressures are displayed. Dashes ("-.-") appear instead of the tire pressures.



HP2-520



HP3-507

Tire type info in Tire pressure menu

Information about the currently set tires:

- Tire type: Summer tires, winter tires
- Tire size: 18, 19 inch

"Info tires" shows the current tire settings.

Calling up the "Info tires" display

- f Push operating lever forward in order to switch on the selection field.
- f Select "TPM" with the operating lever.
- f Push operating lever forward.
The display changes to the tire pressure menu.

- f Select "Info tires" with the operating lever.

- f Push operating lever forward.

Tire selection in the "Set" menu

- f Push operating lever forward in order to switch on the selection field.
- f Select "TPM" with the operating lever.



- f Push operating lever forward.
The display changes to the tire pressure menu.



- f Select "Set" with the operating lever.



- f Push the operating lever forward.
- f Select desired tire type:
summer or winter.
- f Push operating lever forward.
A display for confirming the selected type of
tire appears.



f Select "Continue" and push the operating lever forward.



f Select the appropriate tire size (18 or 19 inch) and push operating lever forwards. A display for confirming the selected tire size appears.



f Select "Continue" and push the operating lever forward.

Note

This menu is displayed only if the tire pressures are different for the approved tire sizes.



HPZ-528

The tire selection has only been successfully completed when the message "Process complete" is displayed by the on-board computer.

- f Select arrow (Back) and push the operating lever forward. The display returns to the tire pressure menu. The on-board computer additionally displays the message "System learning".

Note

The message "Process aborted" appears if the setting process is interrupted. All entries made up to this point are lost, and the original settings remain in effect.

Only if the message "Process complete" appears after the settings have been made will the Tire Pressure Monitoring re-learn the wheels.

- f Please see the chapter "SYSTEM LEARNING" on Page 150.

Before fitting tires with sizes which are not stored in the on-board computer, the missing information should be supplemented in the on-board computer.

- f Please consult your authorized Porsche dealer.

- f Use only tires approved by Porsche.

The available items in the tire pressure menu depend on the tires on your vehicle. For this reason it is possible that some of the items shown here are not available on your on-board computer's display.

- f Make sure that tire pressures correspond to the on-board computer settings. Correct the tire pressure if necessary.

- f Please see the chapter "TIRE PRESSURES FOR COLD TIRES (68 °F / 20 °C)" on Page 289.



HPZ-518

Load

- f Push operating lever forward in order to switch on the selection field.
- f Select "TPM" with the operating lever.
- f Push operating lever forward. The display changes to the tire pressure menu.
- f Select "Load" with the operating lever.



H92-521

Tire pressure warnings

The tire pressure warning light on the instrument panel and a corresponding message on the on-board computer warn about loss of pressure in two stages, depending on the amount of pressure loss.

Driving with insufficient tire pressure reduces the road safety of the vehicle and destroys the tire and wheel.

Stage 1 – Add air

The pressure in the tire is too low by 4 to 7 psi (0.3 to 0.5 bar).

- f The tire pressure warning contains the affected tire with the tire pressure to be added. Correct the tire pressure at the next opportunity.

- f Select partial load or full load and push the operating lever forward.
- f Please see the chapter "TIRE PRESSURES FOR COLD TIRES (68 °F / 20 °C)" on Page 289.
- f Make sure that the tire pressures correspond to the on-board computer settings. Correct the tire pressures if necessary.



H83-531

This tire pressure warning appears

- for approx. 10 seconds with vehicle stopped when switching off the ignition **or**
- again when switching on the ignition.

With ignition on, the warning can be deactivated.

The tire pressure warning light in the instrument panel goes out only when the tire pressure has been corrected.



H43-532

This tire pressure warning also appears when driving and can be acknowledged. The tire pressure warning light on the instrument panel goes out only when the tire pressure has been corrected.

Stage 2 – Flat tire

At speeds **below** 100 mph (160 km/h):

The pressure in the tire has dropped by **more than 7 psi (0.5 bar)**. This significant pressure loss is a danger to road safety.

At speeds **above** 100 mph (160 km/h):

The pressure in the tire has dropped by **more than 5 psi (0.4 bar)**. This significant pressure loss is a danger to road safety.

- f When the tire pressure warning appears, stop immediately at a suitable location. Check the indicated tire for signs of damage. If necessary, fill in tire sealant and set the correct tire pressure.

150 Instruments, On-Board Computer, Warnings

System learning

The Tire Pressure Monitoring begins to “learn” the wheels after a wheel change, wheel transmitter replacement or update of the tire settings. During this process, the Tire Pressure Monitoring recognizes the tires and their locations.

The on-board computer displays the message “TPM is learning, monitoring not act.”.

The Tire Pressure Monitoring requires a certain amount of time to learn the wheels. During this time, the current tire pressures are not available on the on-board-computer:

- The tire pressure warning light remains lit until all wheels have been learned.
- The display of the tire pressure function of the on-board computer shows lines.
- The required pressures for cold tires at 68 °F (20 °C) are indicated in the Info pressure display in the tire pressure menu.

Position and pressure information is displayed as soon as the Tire Pressure Monitoring has assigned the wheels identified as belonging to the vehicle to the correct wheel positions.

The wheel learning process takes place exclusively when the vehicle is being driven (vehicle speed above 25 km/h (16 mph)).

- f Check the tire pressure for all wheels on the “Info pressure” display.
- f Correct the tire pressure to the required pressure if necessary.

Changing a wheel and replacing tires

- f New wheels must be fitted with radio transmitters for the Tire Pressure Monitoring. Before tires are changed, the battery charge state of the wheel transmitters should be checked at an authorized Porsche dealer.
- f Switch the ignition off when changing a wheel. The tire settings on the on-board computer must be updated after changing a wheel. If the tire settings are not updated, the message "Wheel change? Input new TPM settings!" is displayed on the on-board computer.
- f Update the on-board computer settings when the vehicle is stationary the next time.



Warning light



Warning!

Your vehicle has also been equipped with a Tire Pressure Monitoring (TPM) malfunction indicator when the system is not operating properly. The TPM malfunction indicator is combined with a low tire pressure telltale. When the system detects a malfunction, the telltale will flash for approx. one minute and then remain continuously illuminated. This sequence will continue upon subsequent vehicle start-ups as long as the malfunction exists. When the malfunction indicator is illuminated, the system may not be able to detect or signal low tire pressure as intended. TPM malfunctions may occur for a variety of reasons, including the installation of replacement or alternate tires or wheels on the vehicle that prevent the TPM from functioning properly. Always check the TPM malfunction telltale after replacing one or more tires or wheels on your vehicle to ensure that the replacement or alternate tires and wheels allow the TPM to continue to function properly.

The warning light in the speedometer lights up:

- When a loss in pressure has been detected.
- When learning newly mounted wheels/wheel sensors, as long as the vehicle's own wheels have not yet been recognized.

In the event of a defect in Tire Pressure Monitoring or a temporary fault, the warning light in the speedometer flashes for approx. one minute and then remains continuously illuminated.

The tire pressure warning light in the instrument panel goes out only when the cause of the fault has been rectified.

Partial monitoring

Monitoring of the other wheels is continued if there is a fault in one or two wheel transmitters.

- The tire pressure warning light lights up.
- The message "TPM partial monitoring" is displayed on the on-board computer.
- No tire pressures are displayed on the on-board computer for wheels with faulty wheel transmitters.

No monitoring

In the event of faults the Tire Pressure Monitoring cannot monitor the tire pressure.

The warning light in the speedometer flashes for approx. one minute and then remains continuously illuminated and a corresponding message appears on the on-board computer.

Monitoring is not active when:

- the Tire Pressure Monitoring is faulty,
 - wheel transmitters for the Tire Pressure Monitoring are missing,
 - during the learning phase after the tire settings have been updated,
 - after a wheel change without updating the tire settings,
 - more than four wheel transmitters are detected,
 - there is external interference by other radio sources, e.g. wireless headphones,
 - tire temperatures are too high.
- f Please see the chapter "WARNINGS ON THE INSTRUMENT PANEL AND THE ON-BOARD COMPUTER" on Page 158.

Pressure increase as the result of temperature increase

In accordance with physical principles, the air pressure changes as the temperature changes. The tire pressure increases or decreases by around 1.5 psi (0.1 bar) for every 18 °F (10 °C) change in temperature.

The Tire Pressure Monitoring takes this relationship between tire pressure and temperature into account.

Tire pressure specifications

Information on tire pressure for public roads can be found in this Owner's Manual in the Technical Data chapter or on the tire-pressure plate in the left door aperture.

These values apply to cold tires at 68 °F (20 °C) ambient temperature.

OIL Display and measurement of the engine oil level



Caution!

Risk of engine damage.

- f Regularly check the oil level each time before refueling.
- f Do not allow the oil level to fall below the minimum mark.

Conditions for measuring the oil level

1. Vehicle stationary.
2. It is important to ensure that the vehicle is **horizontal** for correct oil level measurement to occur.
3. Engine must be at operating temperature (at least 140 °F/60 °C).
4. Engine must be idling.



883-501

Initiating oil level measurement

1. Push operating lever forward in order to switch on the selection field.
2. Select "OIL" with the operating lever.
3. Push operating lever forward. Measurement is started.



1162-534

4. Allow waiting time to elapse.
5. Once the measurement has been completed, you can read off the engine oil level on the segment display.



6. If the segments are filled in up to the top line, the oil level has reached the maximum mark. Under no circumstances add engine oil.



7. If the bottom segment is filled in, the oil level has reached the minimum mark.

Add engine oil immediately.

8. If the bottom segment flashes, the oil level has dropped to below the minimum mark.

Add engine oil immediately.

The difference between the minimum and maximum marks on the segment display is approx. 1.3 quarts (1.25 litres). One segment of the display corresponds to a top-up quantity of approx. 0.42 quarts (0.4 litre).

- f Add engine oil if necessary.
Switch off ignition before adding engine oil.

- f Please see the chapter "ENGINE OIL LEVEL" on Page 208.

- f **Never add more engine oil than required to reach the maximum mark.**

Failure

A failure of the oil level display is indicated by a warning message on the on-board computer.

"Check engine oil level" display

The on-board computer display "Check engine oil level" is an additional measurement that takes place in the background while driving.

The display depends on the distance travelled. This display appears if the oil level has reached the minimum mark or if the oil level is well above the maximum mark.

This message must be acknowledged by measuring the engine oil level manually using the on-board computer.

- f Please see the chapter "INITIATING OIL LEVEL MEASUREMENT" on Page 153.

If oil level measurement was initiated manually on the on-board computer and no oil was added, the message "Check engine oil level" is displayed again when the vehicle is driven.

SET Basic setting on on-board computer

Switching on selection field "D"

- f Push operating lever forward.

Changing the basic setting of the on-board computer

- f Select "SET" with the operating lever.



- f Push operating lever forward.
- f Select the desired function with the operating lever:



Reset

- Reset all,
- Reset average consumption,
- Reset average speed,
- Reset trip counter

Units

- Speedometer: km - km/h, miles - mph
- Consumption: l/100 km, mls/gal (USA), mpg (UK), km/l
- Temperature: °Celsius, °Fahrenheit
- Tire pressure: bar, psi

Display
(Select central line of the on-board computer)

- **Change display**
Audio information (set radio station)
Range on remaining fuel
Empty
- **Telephone Info**
When Telephone information is active, incoming telephone calls are displayed on the on-board computer.



Navigation

- Integrated in the BC
(Navigation instructions can be recalled on the on-board computer display)
- When turning off
(Navigation instructions are only shown before changing direction)

Basic setting

- Restore the basic setting of the on-board computer

Language

- Select language version



12/24h mode

Select time mode:

- 12h (small squares on the right side of the time display for AM/PM),
- 24h

Light

USA only:

Switch daytime driving lights on and off.

- Daytime driving lights
(daytime driving lights switched off)
- Daytime driving lights
(daytime driving lights switched on)

General information regarding the on-board computer functions

Range on remaining fuel

The range on remaining fuel is continuously recalculated during the journey based on the fuel level, current consumption and average consumption. The more the fuel level falls, the more spontaneously the display reacts. For this reason, the range on remaining fuel is not displayed if less than 9 miles (15 kilometers).

If the vehicle's inclination changes while driving or refueling, incorrect range information may temporarily be given.

Note

If the tank is nearly empty and you top up with only a small quantity of fuel, an accurate range on remaining fuel is impossible.

Average consumption and average speed

The values displayed are based on the distance travelled since the last reset to "zero".

You can set the starting time for a measurement before or during the trip.

Switching the ignition off does not reset the measurements. It is therefore possible to collect values over long periods.

Disconnecting the car battery will cause these memories to be erased.









Tire pressure







The **Tire pressure** function of the on-board computer displays the tire pressures dependent on temperature in the four wheels. You can watch the tire pressure rise and fall while driving. The display is only for information.











f To correct the tire pressures, always use the displayed values from the "Info pressure" display in the tire pressure menu.

Warnings on the instrument panel and the on-board computer









If a warning message appears, always refer to the corresponding chapters in the Owner's Manual. Warning messages are issued only if all measurement preconditions are met. Therefore, check all fluid levels regularly – in particular, always check the engine oil level before refuelling.













Instrument panel	On-board computer	Text display on on-board computer	Meaning/measure
		Seat belt	Driver and passengers must fasten their seat belts.
BRAKE 		Handbrake	Handbrake is still on.
		Ignition key not removed	
		Replace battery in ignition key	Replace the remote-control battery.
		Ignition lock faulty, please go to workshop	Have the fault remedied at an authorized Porsche dealer.
		Ignition lock faulty, visit workshop now	Have the fault remedied at an authorized Porsche dealer.
		Relieve steering	Relieve the steering lock by moving the steering wheel to the left or right.
		Steering locked	The steering wheel lock remains engaged. Have the fault remedied at an authorized Porsche dealer.
		Lights on	Low beam/side marker lamps on
		Parking light on	Left/right parking light on

Instrument panel	On-board computer	Text display on on-board computer	Meaning/measure
		Check left/right dipped beam (low beam) also applies to: direction indicator, high beam, side indicator light, reversing light, side marker	The reported light is faulty. Check bulb. Have the fault remedied at an authorized Porsche dealer.
		Daytime driving lights off	Daytime driving lights switch off when the engine is shut off. Switch on lights if necessary.
		Headlight beam adjustment faulty	Have the fault remedied at an authorized Porsche dealer.
		Front lid not closed	Close luggage compartment lid properly.
		Rear lid not closed	Close engine compartment lid properly.
		Targa flap not closed	Close glass rear hatch
		Rain sensor faulty	Have the fault remedied at an authorized Porsche dealer.
		Steering wheel heating ON	Steering wheel heating was switched on.
		Steering wheel heating OFF	Steering wheel heating was switched off.
		Launch control active	
		Drive Off Assistant failure	Have the fault remedied at an authorized Porsche dealer.
		Refill washer fluid	





Instrument panel	On-board computer	Text display on on-board computer	Meaning/measure
		LIMIT Cannot be accepted with vehicle stopped	The current speed can only be accepted for the acoustic warning signal when the vehicle is in motion.
		LIMIT 30	Selected speed limit (e.g. 30 mph) for the acoustic warning signal has been exceeded. Adjust your speed if necessary.
Fuel gage warning light		Consider remaining range	Refuel at next opportunity.
		Check engine oil level	Start engine oil level measurement in the on-board computer.
		Engine oil pressure too low	Stop immediately at a suitable place, measure oil level with the on-board computer and, if necessary, add engine oil.
Warning light Temperature gage		Engine temperature too high	Switch engine off and let it cool. Check coolant level and, if necessary, add coolant.
Temperature gage warning light flashes		Check coolant level	Switch engine off and let it cool. Check coolant level and, if necessary, add coolant.
		Engine diagnostics – workshop	Stop immediately at a suitable place and check tank cap for proper fastening. If the tank cap was fastened correctly, consult your authorized Porsche dealer.
		Reduced engine power	Consult your authorized Porsche dealer.
Temperature gage warning light flashes		Failure of engine compartment blower	Consult your authorized Porsche dealer.







160 Warnings

Instrument panel	On-board computer	Text display on on-board computer	Meaning/measure
		Warning Battery/generator	Stop at a safe place and switch the engine off. Do not continue driving. Have the fault remedied at an authorized Porsche dealer.
		Oil pressure gage faulty	Have the fault remedied at an authorized Porsche dealer.
		Oil level display faulty	Have the fault remedied at an authorized Porsche dealer.
		Oil temperature gage faulty	Have the fault remedied at an authorized Porsche dealer.
		Oil temperature too high	Switch engine off and let it cool. Check oil level and, if necessary, add oil. Please observe the chapter "OIL DISPLAY AND MEASUREMENT OF THE ENGINE OIL LEVEL".
		Indicator faulty	Coolant indicator failed. Have the fault remedied at an authorized Porsche dealer.
BRAKE 		Brake pad wear	Have the brake pads changed immediately at an authorized Porsche dealer.
BRAKE 		Warning – Brake fluid level	Stop immediately in a suitable place. Do not continue driving. Have the fault remedied at an authorized Porsche dealer.
BRAKE 		Warning – Brake circuit division	Stop immediately in a suitable place. Do not continue driving. Have the fault remedied at an authorized Porsche dealer.















Instrument panel	On-board computer	Text display on on-board computer	Meaning/measure
		ABS failure	Have the fault remedied at an authorized Porsche dealer.
		PSM off	Porsche Stability Management has been switched off.
		PSM on	Porsche Stability Management has been switched on.
		PSM failure	Have the fault remedied at an authorized Porsche dealer.
		PSM initialisation	Please observe the chapter "PUTTING VEHICLE INTO OPERATION".
		PASM Normal/Sport	Indicator for selected PASM mode
		PASM failure	Have the fault remedied at an authorized Porsche dealer.
		PASM indicator faulty	Have the fault remedied at an authorized Porsche dealer.
		Sport mode failure	Have the fault remedied at an authorized Porsche dealer.
		Airbag system fault	Airbag is faulty. Have the fault remedied at an authorized Porsche dealer.
		Check passenger's seat setting	Weight sensing is impaired on the front passenger's seat (Advanced Airbag). Correct the seating position, set the backrest upright, do not support weight on the armrests, or lift on the handles.



162 Warnings

Instrument panel	On-board computer	Text display on on-board computer	Meaning/measure
		Failure spoiler control	Driving stability is impaired. Adjust your driving style. Reduce speed. Have the fault remedied at an authorized Porsche dealer.
Display of selector lever position flashes		Selector lever is not engaged	Porsche Doppelkupplung: Selector lever can be between two positions. Engage the selector lever correctly.
		Move selector lever to P	Porsche Doppelkupplung: Move selector lever to position P before withdrawing key from ignition lock.
		Apply brake	Porsche Doppelkupplung: Apply the brake when starting.
		Depress clutch pedal	Manual transmission: Depress clutch pedal when starting.
		Move selector lever to position P or N	Porsche Doppelkupplung: The vehicle can be started only in the selector lever position P or N.
		Text display in white: Transmission emergency run	Restricted gearshift comfort, failure of reverse gear. Have the fault remedied at an authorized Porsche dealer.
		Text display in red: Transmission emergency run	No selector lever position is displayed on the instrument cluster. Vehicle can be driven only until it comes to a stop. It is not possible to continue driving. Immediately stop the vehicle in a suitable place. Have the vehicle towed to an authorized Porsche dealer.

Instrument panel	On-board computer	Text display on on-board computer	Meaning/measure
		Transmission temperature too high	Jerking can be felt when driving off, and the engine power may be restricted. Do not hold the vehicle with the accelerator on a hill, for example. Hold the vehicle with the brake. Reduce engine load. If possible, stop the vehicle in a suitable place. Allow the engine to run in selector lever position P or N until the warning disappears.
		System fault Go to workshop	Several systems may have failed. Adjust your driving style. Reduce speed. Have the fault remedied at an authorized Porsche dealer.
		Failure of fuel level indicator Workshop	Have the fault remedied at an authorized Porsche dealer.
		Service in mls/days	Service indicator Bring the vehicle in for service no later than after the distance/time shown has elapsed. Please observe the additional information in the "Maintenance" booklet.
		Service now	Service indicator Have your vehicle serviced at an authorized Porsche dealer.
		Failure Convertible-top control	Activate convertible top in opposite direction. If there is a failure: Consult an authorized Porsche dealer.
		Convertible top not in limit position	Fully open or close convertible top
		Opening convertible top	Message goes out in final position
		Closing convertible top	Message goes out in final position

164 Warnings

Instrument panel	On-board computer	Text display on on-board computer	Meaning/measure
		Rear lid not closed	The convertible top cannot be operated with the rear lid open.
		Flat tyre!	Tire Pressure Monitoring has detected a serious pressure loss. Stop at a suitable place and check tires for damage. Fill in tire sealant if necessary.
		Add air	The Tire Pressure Monitoring has detected a gradual pressure loss. Correct tire pressure at the next opportunity.
		TPM is learning monitoring not act.	The Tire Pressure Monitoring is learning the wheels on the vehicle. The Tire Pressure Monitoring is searching for the tires and their position. During this period the current pressure specifications are not available on the on-board computer.
		TPM inactive	The Tire Pressure Monitoring is faulty. Consult an authorized Porsche dealer.
		TPM partial monitoring	1 or 2 wheel transmitters are faulty. The tyre pressures of these wheels are not monitored. The other wheels are still monitored. Consult an authorized Porsche dealer.
		TPM inactive Brief disturbance TPM inactive Too many wheel transmitters	The Tire Pressure Monitoring is temporarily deactivated by excessive tire temperatures (approx. 248 °F (120 °C)) or external interference (e.g. from other wheel transmitters inside the car). Once the source of the interference is removed, the system is automatically reactivated.
		Wheel change? Input new TPM settings!	Update the settings in the TPM menu of the on-board computer at the next opportunity. Wrong entries will affect the correct pressure information in the menu. The safety of your vehicle is at risk.

Instrument panel	On-board computer	Text display on on-board computer	Meaning/measure
		TPM Indicator faulty	The display of the Tire Pressure Monitoring is faulty. Consult an authorized Porsche dealer.

Acknowledging warning messages

Warning messages can be deleted from the on-board computer display.

f Push the on-board computer operating lever forward.

You can recall erased warning messages in the "INFO" menu.

Shifting Gears

Manual Transmission, Clutch	168
Drive-Off Assistant	169
Porsche Doppelkupplung (PDK)	170



881-205

Manual Transmission, Clutch

The positions of the gears are shown on the shift diagram on the gearshift lever.

Warning!

Risk of accident, resulting in serious personal injury or death.

- f Do not obstruct the pedal travel with floor mats or other objects.
Nonskid floor mats of the correct size are available at your authorized Porsche dealer.

To avoid damage to the clutch and transmission:

- f Always depress the clutch pedal fully when changing gears. Make sure that the gearshift lever is completely engaged.
 - f Only shift into reverse when the car has come to a complete stop.
-
- f When shifting gears, always ensure that the clutch pedal is fully depressed and the gear has fully engaged.
 - f Select reverse only when vehicle is stationary. Reverse can be engaged after pushing the gearshift lever as far as possible to the left.
 - f Select an appropriately low gear on upward and downward slopes.
This will ensure optimum use of engine power and engine braking.

When reverse gear is selected and the ignition is on, the backup lights are illuminated.

Permitted engine speed

- f You should change into a higher gear before the needle reaches the red mark on the tachometer, or ease off the accelerator.

If the red zone is reached during acceleration, fuel feed is interrupted.

Caution!

Risk of engine damage (overrevving) when shifting down to a lower gear.

- f Take care not to exceed the maximum permitted engine speed when shifting down.

Drive-Off Assistant

The Drive-Off Assistant assists the driver when moving off on hills.

The vehicle must have sufficient road contact.

The Drive-Off Assistant is available on gradients as from around 5%.



Risk of accident.

Assistance by the Drive-Off Assistant is not guaranteed when moving off on a slippery surface (e.g. on icy or loose surfaces). In this case, the vehicle could slip.

The limits dictated by the laws of physics cannot be overcome, even with the Drive-Off Assistant. The responsibility for moving off on upward slopes is still the driver's, despite the Drive-Off Assistant.

f Always adjust your driving style to the driving conditions and vehicle load, use the brake pedal if necessary.

Risk of accident.

If the Drive-Off Assistant is not functioning, the driver cannot be assisted when moving off on hills.

f Hold the vehicle with the brake pedal.

Driving off with the Drive-Off Assistant (vehicles with manual transmission)

1. Hold the vehicle securely on the slope with the brake pedal.
The engine must be running.
2. Fully depress the clutch pedal.
3. Engage a gear corresponding to the direction of travel up the slope (1st gear or reverse gear).
4. Fully release the parking brake.
5. While keeping the clutch pedal depressed, release the brake pedal.
The vehicle is held on the slope for a short time in order to allow driving off directly after the brake is released.
6. Move off as usual.

Note on operation

The Drive-Off Assistant is not active:

- If the clutch is not depressed.
- If the vehicle is not stationary.
- If the engine is not running.
- On gradients of less than 5%.
- If the pressure on the brake pedal is too low.

Driving off with the Drive-Off Assistant (vehicles with PDK transmission)

1. Hold the vehicle securely on the slope with the brake pedal.
The engine must be running.
2. Select a gear corresponding to the direction of travel up the slope (selector lever position **D** or **R**).
3. Fully release the parking brake.
4. Release the brake pedal.
The vehicle is held on the slope for a short time in order to allow driving off directly after the brake is released.
5. Move off as usual.

Note on operation

The Drive-Off Assistant is not active:

- In the event of shift to neutral.
- If the vehicle is not stationary.
- If the engine is not running.
- On gradients of less than 5%.
- If the pressure on the brake pedal is too low.

Porsche Doppelkupplung (PDK)

The Porsche Doppelkupplung (PDK) is a seven-speed transmission with an "automatic" and a "manual" selection mode.

In **automatic selection mode** (selector lever position **D**), gear changing is automatic. You can change temporarily from automatic to manual mode using the shift buttons on the steering wheel.

In **manual selection mode** (selector lever position **M**), you change gear using the shift buttons on the steering wheel or with the PDK selector lever.

You can change between selector lever position **D** and **M** as you wish while driving.

Note

- f Take care not to operate the shift buttons on the steering wheel inadvertently in either automatic or manual mode, thereby triggering undesired gear changes.



Changing the selector lever position

The selector lever is locked when the ignition is switched off.

When the ignition is switched on, the selector lever can be moved from position **P** and **N** only when the release button is pressed, and when the brake pedal is pressed.

Release button

The release button (**arrow**) in the selector lever prevents the gear from being changed unintentionally.

The release button must be pressed when shifting to position **R** or **P**.

Starting

The engine can be started only if the brake pedal is depressed and the selector lever is in position **P** or **N**.

Driving off

- f Only select the desired position for driving off (**D**, **M** or **R**) when the engine is idling and the brake pedal is depressed.
- f Since the vehicle creeps when in gear, do not release the brake until you want to move off.
- f After selecting a gear, do not accelerate until you can feel that the gear is engaged.

Driving off on hills

The Drive-Off Assistant assists the driver when moving off on hills. The vehicle is held on the slope for a short time during the change from the brake pedal to the accelerator in order to allow driving off directly after the brake is released.

- f Please see the chapter "DRIVE-OFF ASSISTANT" on Page 169.

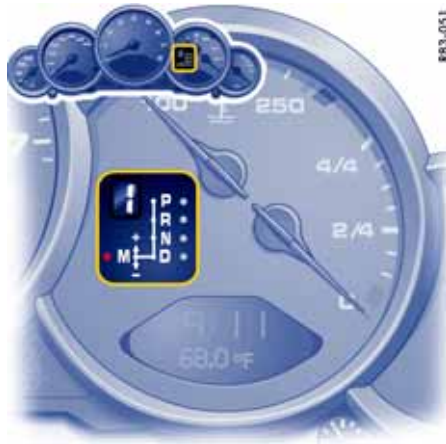

Indicator for selector lever position and engaged gear

When the engine is running, the selector lever position and engaged gear are indicated.

If the selector lever is between two positions

- Effects:
The corresponding selector lever position flashes on the instrument cluster **and** the warning "Apply brake" or "Selector lever not engaged" appears on the on-board computer.
- f Remedy:
Operate the footbrake and engage the selector lever properly.

If the selector lever is inadvertently (due to a defect or incorrect operation) moved out of **P** or **N** into gear without pressing the brake, this gear will start to "flash" and no power transmission is built up.

- f To drive off, press the brake and move the selector lever from **P** or **N** into the required gear again.

Selector lever position R or D is flashing in the instrument cluster

- Effects:
There is no power transmission.
The selector lever was engaged without pressing the footbrake or only the restricted driving programme is available when the "Transmission emergency run" message is displayed.
- f Action required:
Press the footbrake and engage the required selector lever position again by moving the selector lever from **P** or **N**.
If reverse gear fails:
- f Please see the chapter "REDUCED DRIVING PROGRAM" on Page 176.

If there is a fault in the transmission:

- The warning "Transmission emergency run" in white or red lettering or the warning "Transmission temperature too high" is displayed on the on-board computer.
Please see the chapter "REDUCED DRIVING PROGRAM" on Page 176.
- f Have the fault repaired immediately at an authorized Porsche dealer.

Selector lever positions

P – Parking lock

- f Engage parking lock only when vehicle is stationary.
If selector lever position **P** is flashing in the instrument cluster, the parking lock is not engaged. The vehicle can roll away.
Engage selector lever position **P** again by moving the selector lever out of **R**.
- f Engage parking lock **after** applying the handbrake and release it **before** releasing the handbrake.

The **ignition key** can be withdrawn only in selector lever position **P**.

R – Reverse gear

- f Select only if car is stationary and the brake is applied.

N – Neutral

Selector lever position **N** must be selected for towing or in car washes, for example.

- f Only select the desired position for driving off (**D**, **M** or **R**) when the engine is idling and the brake pedal is depressed.

D - Automatic selection mode

Select position **D** for “normal” driving. The gears are shifted automatically according to the accelerator position and speed.

Depending on the way the vehicle is driven (economical, comfortable or sporty driving style) and on the resistance (e.g. uphill), the gear-changing points are shifted towards higher or lower engine-speed ranges.

The accelerator position, driving speed, engine speed, longitudinal and lateral acceleration and the road profile all have an influence on the gear-changing characteristic.

Unwanted upward shifts, e.g. before bends, are prevented by swiftly releasing the accelerator pedal.

Depending on lateral acceleration, upward changes on bends are not made until the engine-speed limit is reached.

Under braking, and depending on the amount of deceleration, the PDK transmission changes down earlier.

For subsequent cornering, the right gear is engaged when pressure is applied to the brakes before the bend. The bend is taken in the right gear, and when you accelerate out of the bend you do not have to change down.

With a sporty driving style, downshifts are already initiated when the brake pedal is touched lightly. This further enhances a dynamic driving style. The PDK transmission temporarily changes to the sportiest gear-changing map, i.e. to the highest possible gear-changing points, if the accelerator pedal is pressed quickly. The transmission accordingly shifts down immediately by one or two gears (temporary change-down).

The transmission no longer selects 7th gear at high driving speeds.

Sport mode (“Sport” and “Sport Plus” modes)

“Sport” mode activated:

The PDK transmission switches to a sporty gear-changing map and shortens the gear shifting times.

A sporty driving style is recognised more quickly and the gear-changing speeds are adapted to driving performance.

Deceleration downshifts are commenced earlier. Downshifts are already carried out in the case of slight decelerations, even at higher engine speeds.

“Sport Plus” mode activated:

In “Sport Plus” mode, the PDK transmission changes to a shift program designed for driving on race circuits. 7th gear is not selected. The gear-changing performance is enhanced significantly again compared with “Sport” mode.

f Please see the chapter “SPORT MODE” on Page 64.

Driving with Launch Control

Driving with Launch Control allows you to achieve maximum acceleration from a standing start. It is intended to provide you with a unique enjoyment of your vehicle under controlled circumstances and is not intended to be used in any location where it could be a nuisance to other persons.

Warning!

There is a risk of endangering other road users if you use this Control in an improper location or in a situation where other persons might need to take evasive action due to the rapid acceleration that this technology permits.

- f Launch Control is designed to be used in a controlled environment on closed circuit driving courses where no vehicle cross traffic or pedestrian traffic is present.
- f Use Launch Control only if conditions permit it to be applied in a safe manner.

- f Do not use Launch Control if there is a possibility it could endanger other persons. Such a possibility exists if you cannot see that you have a clear road with no possibility of cross traffic in your intended direction of driving.

Caution!

Stress on components increases dramatically when starting with maximum acceleration in comparison with normal driving off. **Use of Launch Control will inevitably reduce the life of the engaged engine and transmission components.**

Preconditions:

- Launch Control should only be used when the engine has reached operating temperature.
 - “Sport Plus” mode must be switched on (light-emitting diode in button is on and “SPORT PLUS” is displayed on the on-board computer).
1. Press the brake with your left foot.
 2. Quickly press down the accelerator fully (kickdown activated) and hold.
The engine speed will flatten out at around 6500 rpm.
“Launch Control active” is displayed on the on-board computer.

3. Release the brake within a few seconds.

Remaining stationary for a long time with “Launch Control active” can lead to overloading of the transmission.

In order to protect the transmission, the engine power is then reduced and the “Launch Control active” process is cancelled.

Shifting gears on the steering wheel

With the shift buttons on the steering wheel, you can change temporarily from automatic selection mode **D** to manual mode **M**.

For example:

- Shifting down before bends and on entering built-up areas.
- Shifting down on downward slopes (engine braking).
- Shifting down for brief spurts of acceleration.

Manual selection mode remains engaged:

- for cornering (depending on the lateral acceleration) and overrunning,
- when the vehicle is stationary (e.g. at a junction).

The system leaves manual selection mode:

- automatically after approx. 8 seconds (unless cornering or overrunning),
- after driving off.

Kickdown

The kickdown function is active in selector lever positions **D** and **M**.

- f For optimum acceleration, e.g. when overtaking, depress the accelerator pedal beyond the full-throttle point (kickdown).

The transmission shifts down depending on the speed of travel and engine speed. Upward shifts occur at the highest possible engine speeds.



M – Manual selection mode

The currently selected gear is retained when you change from **D** to **M**.

If you change from **M** to **D**, the gear-changing map suitable for your current driving style is selected and the appropriate gear is selected.

The selector lever and the two shift buttons in the top steering wheel spokes allow you to comfortably and reliably select the seven forward gears.

Shifting up +

- f Press the PDK selector lever or shift button on the steering wheel forward.

Shifting down –

- f Pull the PDK selector lever or shift button on the steering wheel back.

You can shift up or down by the corresponding number of gears by quickly pressing or pulling the shift buttons or selector lever several times in succession.

The transmission can be shifted up or down by several gears in succession by continuously operating the selector lever or shift buttons.

Depending on driving speed and engine speed, you can shift up or down at any time.

Gear changes which would exceed the upper or lower engine speed limit are not executed by the controller.

There is no automatic upshift at the upper engine speed limit in selector lever position **M**. Upshift suppression can be cancelled by kickdown operation. If, for example, the engine speed limit is reached during overtaking and the automatic upshift does not occur, the transmission in this case shifts up as a result of kickdown operation.

- f Select an appropriately low gear on upward and downward slopes.
This will ensure optimum use of engine power and engine braking.

In order to shift up automatically at the upper engine speed limit:

- f Depress the accelerator pedal beyond the full-throttle point (kickdown).

Failure of the selector lever display on the instrument cluster

The warning "Transmission emergency run" is displayed in red on the on-board computer.

- Effect:
No selector lever position is displayed on the instrument cluster.
Vehicle can be driven only until it comes to a stop.
Remedy:
It is not possible to continue driving. Immediately stop the vehicle in a suitable place. Have the vehicle towed to an authorized Porsche dealer.

Stopping

- f For a brief stop (e.g. at a traffic light), leave the selector lever in drive position and hold the vehicle with the brake pedal.
- f Do not hold the car on a slope using the accelerator. Use the brake pedal or the handbrake instead.
- f Before leaving the vehicle, always apply the handbrake and move the selector lever to position **P**.

Parking

- f Go easy on the accelerator!
- f When parking or manoeuvring in a small space, control the speed by careful use of the footbrake.

Driving in winter

In wintry road conditions it is advisable to take steep inclines in manual mode. This prevents gear changes occurring that could cause wheelspin.

Tow-starting, towing

- f Please see the chapter "TOWING" on Page 280.

Reduced driving program

If there is a fault in the transmission

- Depending on priority, the warning "Transmission emergency run" in white or red lettering or the warning "Transmission temperature too high" is displayed on the on-board computer.

Warning "Transmission emergency run" **white**

- Effects:
Restricted gearshift comfort,
Reverse gear may not function.

Remedy:

Have the fault repaired immediately at an authorized Porsche dealer.

Warning "Transmission emergency run" **red**

- Effect:
Vehicle can be driven only until it comes to a stop.
Remedy:
It is not possible to continue driving. Immediately stop the vehicle in a suitable place. Have the vehicle towed to an authorized Porsche dealer.

Warning "Transmission temperature too high"

- Effects:
"Warning jerks" can be felt when driving off and the engine power may be restricted.
Remedy:
Do not hold the vehicle with the accelerator on a hill, for example. Hold the vehicle with the brake. Reduce engine load. If possible, stop the vehicle in a suitable place. Allow the engine to run in selector lever position **P** or **N** until the warning disappears.

Mobile Roofs

Lifting/Sliding Roof.....	178
Convertible Top.....	181
Emergency operation of the convertible top	183
Windstop.....	190
Hardtop.....	194
Targa.....	200
Roof Transport System.....	204

Lifting/Sliding Roof

Warning!

Risk of injury when operating or automatically closing the lifting/sliding roof.

- f Take care to ensure that nobody can be injured when the lifting/sliding roof is operated.
- f Always withdraw the ignition key when leaving the vehicle. Uninformed persons (e.g. children) could injure themselves by operating the lifting/sliding roof.
- f In case of danger, release the button immediately and operate the lifting/sliding roof in the opposite direction.

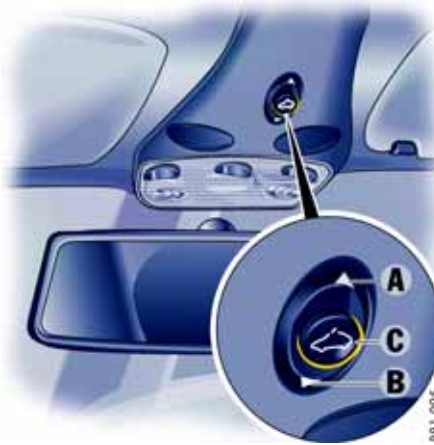

A - Opening the lifting/sliding roof

- f Press rear of rocker switch **A** until lifting/sliding roof reaches the desired position.

One-touch operation

- f Touch rear of rocker switch **A**.
Lifting/sliding roof opens to its end position.
Stop it in any position by touching any button.

Note

The lifting/sliding roof opens until it reaches the best position relative to noise. It can be opened fully, however, if you press the rocker switch again.

Readiness for operation

- When the ignition is switched on (engine switched on or off) **or**
- With doors closed and ignition key withdrawn, but only until a door is first opened.

B - Closing the lifting/sliding roof

- f Press front of rocker switch **B** until lifting/sliding roof reaches the desired position.

C - Lifting the lifting/sliding roof

- f Press center of rocker switch **C** until lifting/sliding roof reaches the desired position.

One-touch operation

- f Touch the rocker switch **C** in the center. Lifting/sliding roof opens to its end position. Touch button again to stop in any position.

B - Lowering the lifting/sliding roof

- f Press front of rocker switch **B** until lifting/sliding roof reaches the desired position.

Emergency operation

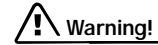

Warning!

Risk of serious personal injury and damage to the lifting/sliding roof during emergency operation.

- f Do not operate the lifting/sliding roof with the rocker switch during and after emergency operation.

Before using emergency operation, please check whether defective fuses are the cause of the malfunction.

- f Please see the chapter "ELECTRICAL SYSTEM" on Page 257.



Closing the sliding roof

1. Carefully unclip both covers **A** with a screwdriver. If the car is equipped with HomeLink, the HomeLink buttons must be carefully unclipped instead of the covers.
2. Unscrew the two screws **B**.



3. Fold down the cover of the lifting/sliding roof drive at the rear.
Remove the Allen key (**arrow**) from its holder.
4. Insert the Allen key into the drive axle.



5. Press the Allen key into the drive axle, **keep it pressed in** and turn it clockwise until the lifting/sliding roof is closed.
6. Remove the Allen key.
Close the cover and screw in the screws.
7. Have the fault remedied at an authorized Porsche dealer.

⚠ Caution!

Risk of damage to the lifting/sliding roof.

- f After emergency operation, do not operate the lifting/sliding roof using the rocker switch.
- f Drive slowly to an authorized Porsche dealer in order to have the fault remedied.

Convertible Top

Brief operating instructions can be found on the back side of the driver's sun visor.

- f Please see the chapter "CAR CARE INSTRUCTIONS" on Page 224.



Warning!

When opening or closing the convertible top, serious personal injury may occur if a person's body parts are near or in the way of the convertible top mechanism's moving parts.

- f Make absolutely sure that nobody can be injured by the convertible-top mechanism or the convertible-top compartment lid.

Do not operate convertible top:

- At temperatures below 32 °F (0 °C).
- When one side of the car is on a curb, a hoist or a jack.
- When items of luggage or other objects hinder the convertible top movement.
- With the rollbars extended.

- f Avoid frequent operation of the convertible top with the engine off; the vehicle battery would be unintentionally discharged rapidly.
- f Drive only with the convertible top fully open or closed (end positions).
- f When opening or closing the convertible top, ensure there is sufficient clearance above the convertible top (e.g. in the garage).
- f To prevent damp stains and abrasions, only open the convertible top in a dry, clean state.
- f Park your car in the shade whenever possible, as the fabric, rubber material and color can be harmed by long exposure to sunlight.
- f The convertible top may only be actuated during driving on even surfaces.
- f The convertible top must not be used with strong counter wind (over approx. 50 mph/ 80 km/h).

Door windows and side windows

The side windows are lowered automatically when the convertible top is **opened**. The door windows close automatically if convertible top operation is not interrupted when the convertible top reaches its final position.

When the door windows are closed, the rear side windows can also be closed.

When opening the door windows, the rear windows open automatically.

The side windows are lowered automatically when the convertible top is **closed**. All windows close automatically if convertible top operation is not interrupted when the convertible top reaches its final position.

Preconditions for operation of the convertible top

- The ignition must be switched on (engine running or off),
 - the engine compartment lid must be closed,
 - the speed must be below approx. 30 mph (50 km/h).
If this maximum speed is exceeded, the opening/closing procedure of the convertible top will be interrupted.
- f Reduce speed.
Press button again.
The opening/closing process is ended.

Warning!

Risk of injury and damage when operating the convertible top.

- f Make absolutely sure that nobody can be injured by the convertible-top mechanism or the convertible-top compartment lid.
- f Before opening the convertible top, make sure that there are no objects behind the rear seats.
- f Keep the lids of the make-up mirrors in the sun visors closed when closing the convertible top.
- f In order to abort convertible top operation in the event of danger, immediately release the switch.



Opening convertible top

- f Pull the switch and hold without interruption until the convertible top is in the final position or until the door windows are in the desired position.
The message on the on-board computer goes out.
In case of danger, release the switch.
Convertible top operation stops.



Closing convertible top

- f Pull the switch and hold without interruption until the convertible top is in the final position or until the door windows are in the desired position.
The message on the on-board computer goes out.
In case of danger, release the switch.
Convertible top operation stops.



If the convertible top does not lock in the windshield frame

- f Open convertible top again, start the engine and close the convertible top again using the switch.
Assist with the closing process by grasping the convertible top at the handhold and pulling it toward the windshield frame (arrow).
- f Please see the chapter "WARNINGS ON THE INSTRUMENT PANEL AND THE ON-BOARD COMPUTER" on Page 158.

Messages in on-board computer

Rear lid

If the engine compartment lid is open when activating the convertible top, a message appears in the on-board computer. The convertible top cannot be opened.

- f Close engine compartment lid.

Convertible top status

- f Please see the chapter "WARNINGS ON THE INSTRUMENT PANEL AND THE ON-BOARD COMPUTER" on Page 158.

Emergency operation of the convertible top

- f Before performing emergency operation, please check:
Was the ignition switched on and was the engine compartment lid closed during operation of the convertible top with the switch?
Are electrical fuses defective?
Please see the chapter "ELECTRICAL SYSTEM" on Page 257.

Warning!

There is danger of injury and damage during emergency operation.

There is danger of crushing or trapping body parts at all movable convertible top parts which could cause serious personal injury.

- f Take great care when performing emergency operation.
- f Do not operate the convertible top during and after emergency operation.

Before emergency operation

- f Remove the ignition key so that the convertible top is not operated unintentionally.
- f Take screwdriver out of the tool kit.
- f Fold the rear seat backrests forward.



Removing rear wall lining

1. Unscrew screws **A** from the rear wall lining. Pull out and reposition the screwdriver insert if necessary.
2. Grasp the rear wall lining at the cut-outs for the safety belts and press downward. Pull rear wall lining forward and lift up and out.

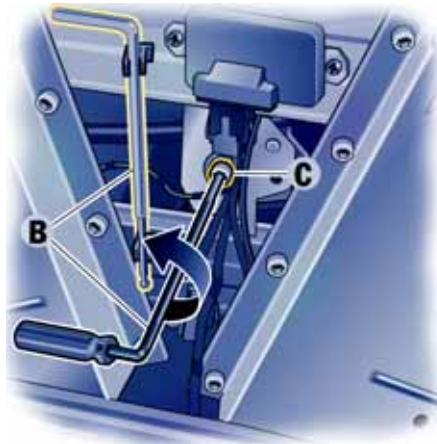

Opening convertible top compartment lid "D"

1. Take red Allen key **B** out of its holder.
2. Put handle of screwdriver onto Allen key **B**. Insert Allen key into the drive axle **C** and turn it counterclockwise (in direction of the arrow) until the convertible top compartment lid **D** is fully open. Remove the Allen key.

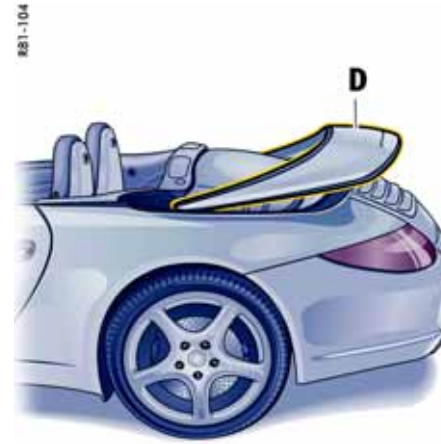

Warning!

The Allen key can rotate or fly out and thereby cause serious personal injury if the convertible top is actuated.

- f Always remove the Allen key **B** from the drive axle **C** before operating the convertible top.

When you have opened the convertible top compartment lid, try to close the convertible top using the switch.

If the convertible top cannot be closed, continue with emergency operation.



Opening side flaps "F"

1. Remove ignition key.
2. Use the screwdriver to remove plastic lid **E** from the lining from behind.

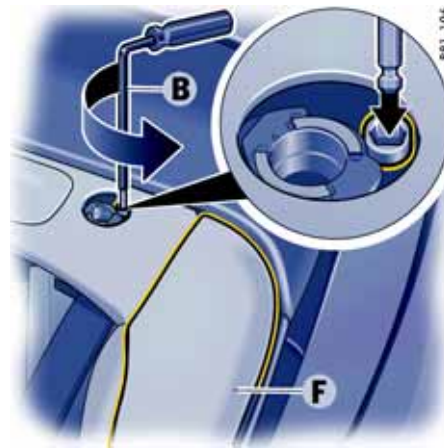

3. Insert Allen key **B** into the drive axle for the left side flap **F**.
Turn Allen key counterclockwise (in direction of arrow) until the side flap **F** is fully open (perceptible stop).
4. Repeat procedure with the right side flap.
Remove the Allen key.

Warning!

The Allen key can rotate or fly out and thereby cause serious personal injury if the convertible top is actuated.

- f Always remove the Allen key **B** from the drive axle of the side flap before operating the convertible top.
- f When you have opened the side flaps, try to close the convertible top using the switch. If the convertible top cannot be closed, continue with emergency operation.

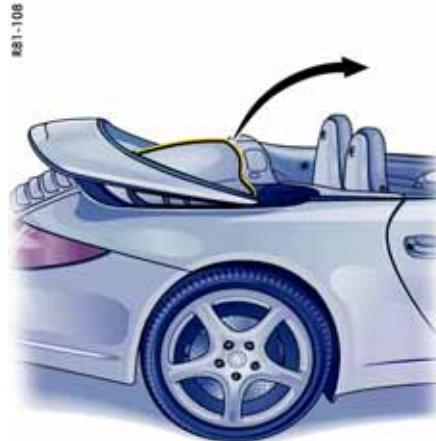
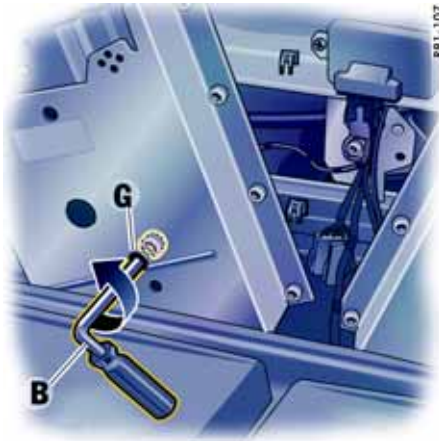

Closing convertible top

1. Insert Allen key **B** through hole **G** and into the hydraulic valve.
Turn Allen key **B** counterclockwise by approx. 1 revolution.
Always remove Allen key **B**.

2. Get behind the front seats and grasp the convertible top in the middle.

3. Close the convertible top until it reaches its highest position.

#B1-110

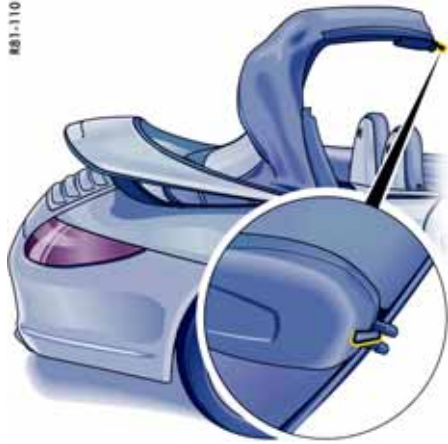

The convertible top lock with the locking hook is fitted on the convertible top. Perform the work on the convertible top lock when standing on the right-hand side of the vehicle.



#B1-111

Extending the locking hook "H"

1. Pull the plastic lid **J** down on the front corners. Push the lid carefully to the rear and take it off.

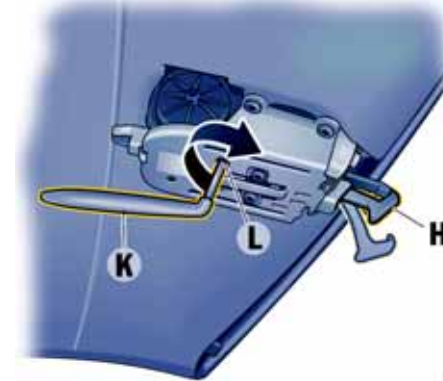

#B1-112

2. Take the Allen key **K** out of the oddments tray between the front seats.
3. Insert the Allen key **K** into the opening **L** and turn in the direction of arrow "open" until marked resistance can be felt. The locking hook **H** is now extended.
4. Pull out the Allen key **K**.



5. Pull the convertible top all the way forward to the windshield.

Locking the locking hook "H" in the windshield frame

- f When locking the convertible top, make sure that the locking hook engages in the windshield frame. Pull the convertible top to the windshield frame if necessary. The centering journals **M** must be retracted into the mounting in the windshield frame.



1. Insert the Allen key again. Turn in the direction of arrow "close" until you can feel marked resistance and the convertible top is completely locked.
2. Remove the Allen key.



Mounting the plastic lid

- f Push the plastic lid over the convertible top locking mechanism from behind. The lid must engage centred in the guide **N**. Push the lid upwards at its front edge and engage.



Warning!

Risk of injury in an accident.

- f Do not drive without the plastic lid mounted.

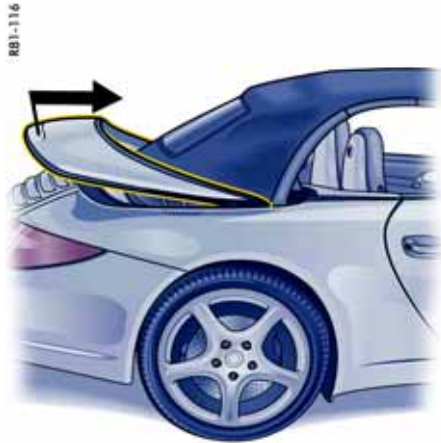

Closing the convertible-top compartment lid

Warning!

Risk of pinching when closing the convertible-top compartment lid.

- f Place your hands on the convertible-top compartment lid when pushing.
-
1. Stand behind the vehicle.
 2. Grasp the convertible-top compartment lid above the brake light and push forward against resistance which can be felt until it is completely closed.

Caution!

Risk of damage to the convertible top.

- f After emergency operation, do not operate the convertible top using the switch.
- f Drive slowly to an authorized Porsche dealer in order to have the fault remedied.



Example: Mount for 911 Carrera, 911 Carrera S

Windstop

The windstop is stowed in a protective bag in the luggage compartment.

The protective bag is fastened with a Velcro strip in the luggage compartment.

Caution!

Risk of damage to the windstop

- f Make sure that the windstop is not damaged by items of luggage or objects in the luggage compartment.
- f Do not place any objects on the windstop.
- f Do not store any sharp-edged objects under the installed windstop.
- f Do not damage the windstop during seat adjustment and when folding back the front-seat backrests.
Adjust seat so that the seat backrest does not touch the windstop.
- f Do not fold up the rear seat backrests with the windstop installed.
- f Remove windstop before fitting a hardtop.

Installing the windstop

1. Open zipper of the protective bag.
Take the windstop out of the luggage compartment.

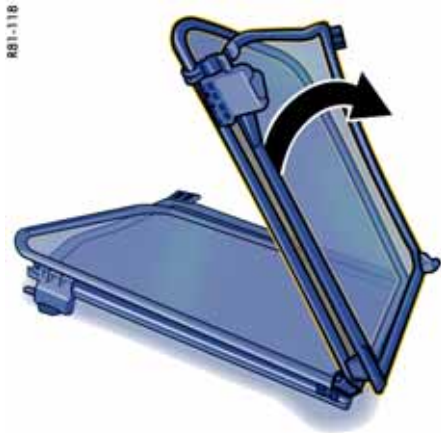

2. Fold the rear seat backrests forward. Please see the chapter "REAR SEAT BACKRESTS" on Page 37.
3. Unfold the windstop until it can be felt to engage in the hinges at the top and bottom.



4. Check whether the lock of the windstop lower section is engaged. Press lock together if necessary (**arrows**).

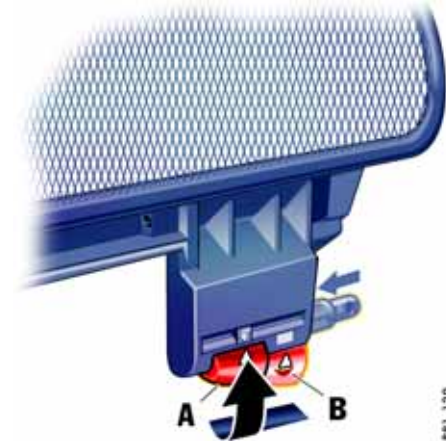

- A** - Lock open
B - Lock closed
5. Check whether the two red locking handles are in position **A** (open). Open the lock if necessary. To do this, push the locking handles inward as far as they will go and swivel to the side (**arrow**).

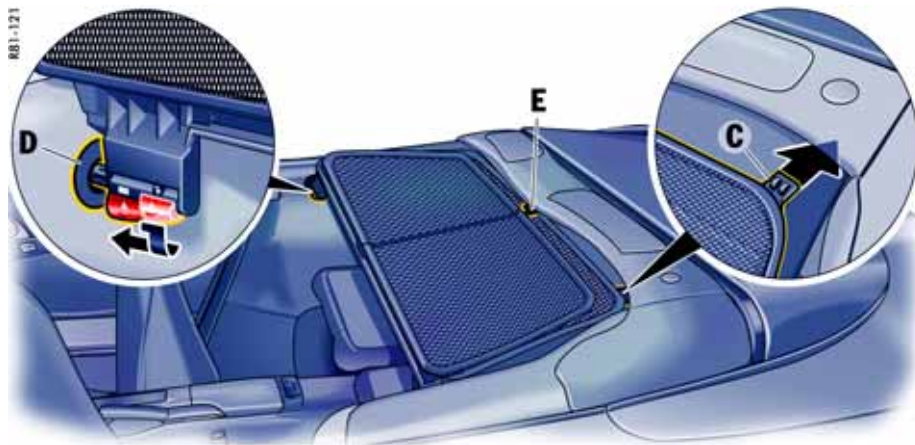

6. Insert fastening tabs **C** of the windstop into the guides of the safety belts. Make sure that the plastic peg **E** engages in the center guide of the windstop.

7. Push red locking handles inward and swivel downward. Spring force pushes the square pins of the locks into the receivers **D** in the side trim panels. Check whether the square pins are correctly engaged.

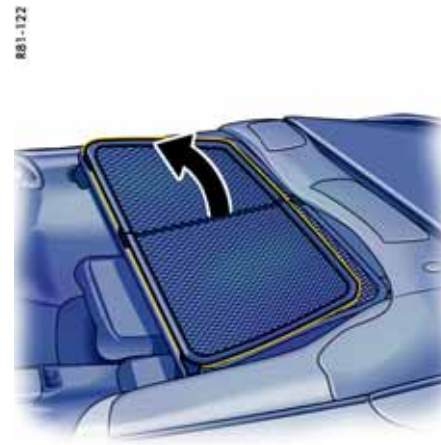

8. Lift upper section of windstop if required.

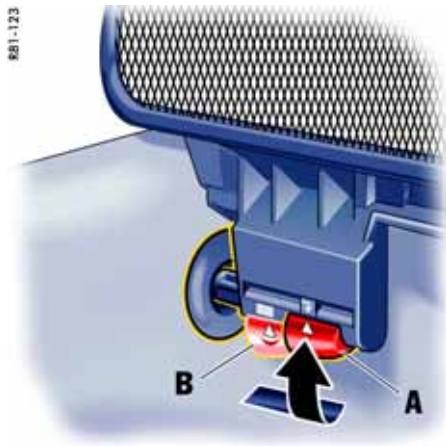

A - Lock open
B - Lock closed

Removing the windstop

1. Fold back upper section of windstop.
2. Move both red locking handles to position **A** (open).
3. Pull windstop out of the guides of the safety belts.

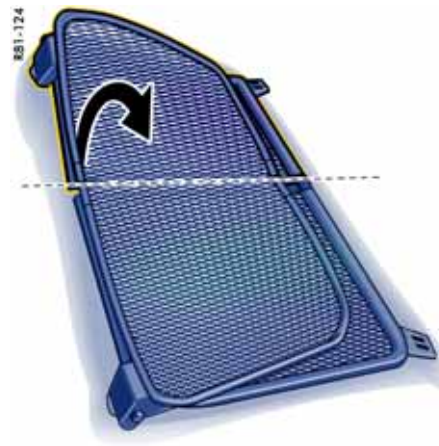

4. Fold the windstop together so that the split windstop lower section is on the outside.
5. Place windstop in the protective bag in the luggage compartment and seal the zipper of the protective bag.
 Please see the chapter "INSTALLING THE WINDSTOP" on Page 190.

Hardtop

Your authorized Porsche dealer will be glad to give advice about correct hardtop storage.

Since the convertible top stays open for a long time, it must be absolutely dry and clean before being opened to install the hardtop. This prevents damp stains and abrasion damage.

- f Make sure that the hardtop is placed on a clean, soft surface.



Removing the hardtop

1. Open all four side windows.
2. Pull off plastic cover of the front hardtop lock (arrow).



3. Press red locking button **A** of the front locking lever.
Fully open locking lever **B**.

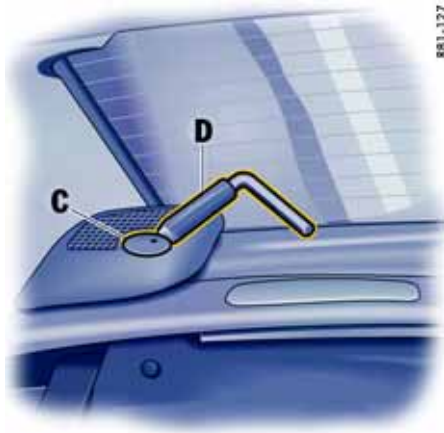

881-127



881-128

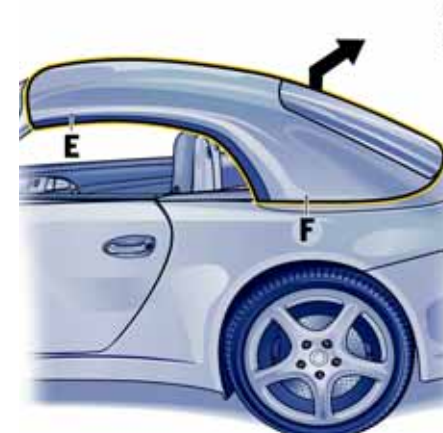

881-129

4. Take unlocking handle **D** from the storage tray between the front seats.
5. Position unlocking handle **D** on the dot marking.
Carefully remove the plastic covers **C** on both sides of the hardtop.

6. Insert unlocking handle **D** into one of the rear hardtop locks.
Unscrew the fastening screw approx. 2 turns, pull off the handle, and completely unscrew the screw by hand (approx. 8 turns).
7. Pull out the fastening screw up to the stop and turn it anticlockwise 2 turns (to prevent damage).
8. Repeat procedure on the other side of the hardtop.

9. Together with a second person on the other side, grasp the hardtop at points **E** and **F**.



Warning!

Danger of pinching fingers or hands at the points "F".

f Evenly lift the hardtop at both sides.

10. First pull the hardtop rearward and up out of the locking elements.
Carefully lift the hardtop up and over the vehicle to the rear.

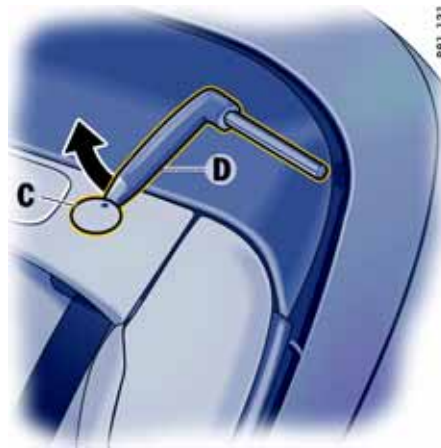

11. Carefully remove both protection covers **J** to the rear.
12. Fit both plastic covers **C** into the trim panel. The marking point must point to the rear. These covers are also used with the hardtop.
13. Close front locking lever. Push on plastic cover of the front hardtop lock.

Putting on the hardtop

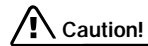

Caution!

Risk of damage to the windstop and hardtop.

- f Always remove the windstop before fitting the hardtop. Please see the chapter "WINDSTOP" on Page 190.

1. Open all four side windows and convertible top.
2. Take unlocking handle **D** from the storage tray between the front seats. Position unlocking **D** on the point marking.

Carefully remove both plastic covers **C** on both sides of the hardtop.
3. Carefully fit both protective covers **J** into the trim panel from behind.



881-133



881-139

4. Pull off plastic cover of the front hardtop lock.
5. Press red lock button of the front locking lever. Fully open locking lever.

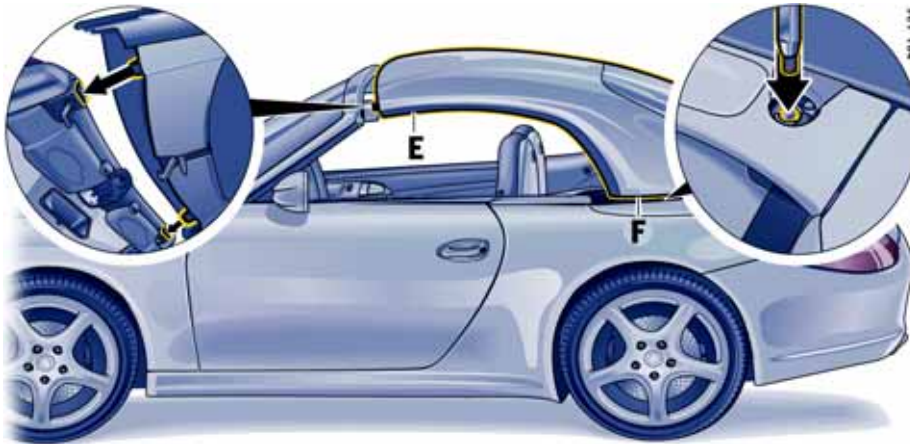

6. Check whether the rear screw connections on the hardtop are loosened (turn it 2 turns clockwise).
7. Together with a second person on the other side, grasp the hardtop at points **E** and **F**.
8. Carefully lift the hardtop up and over the vehicle from behind.

Warning!

Danger of pinching fingers or hands at the points "F".

- f Evenly lower the hardtop at both sides.

9. First push the hardtop completely into the guides on the windshield frame. Then carefully lower the hardtop into the locking elements at the rear.

Caution!

Danger of damage due to inadvertent operation of the convertible top with the hardtop fitted.

- f Make sure that the front locking lever **G** is always correctly locked. This disables the convertible top drive.



10. Swivel front locking lever **G** to the rear.
The latching hook **H** must engage in the windshield frame (**arrow**).
The white marking line **J** on the red locking button must become visible when the hardtop is locked properly.
11. Push on plastic cover of the front hardtop lock.



12. Tighten the fastening screw by hand.
Then tighten the fastening screw with the unlocking handle **D** (tightening torque 34 ftlb. (46 Nm)).
13. Repeat procedure on the other side of the hardtop.



14. Fit both plastic covers **C** into the trim panels of the rear hardtop locking elements so that the marking points are opposite each other.
15. Store unlocking handle in storage tray between the front seats.

Targa

This roof type is equipped with the following special features:

- Roller blind
- Sliding glass roof
- Glass rear hatch

Warning!

Risk of injury when operating all components of the Targa roof, especially when closing the sliding glass roof.

- f Take care to ensure that nobody can be injured when the roof components are actuated.
- f Always withdraw the ignition key when leaving the vehicle. Uninformed persons (e.g. children) could injure themselves by operating the sliding glass roof, the roller blind or the glass rear hatch.
- f In case of danger, release the button immediately and operate the sliding glass roof or roller blind in the opposite direction.



Roller blind

Readiness for operation

- With the ignition switched on (engine on or off)
or
- When door is closed and ignition key withdrawn, but only until door is first opened.

The roller blind can be operated independently of the sliding glass roof position.

Warning!

Risk of injury and damage.

- f Before operating the roller blind, ensure that there are no persons or objects in the range of movement.

Opening the roller blind to the desired position

- f Pull the rocker switch and hold it until the roller blind has reached the desired position.

Opening the roller blind fully (one-touch operation)

- f Pull the rocker switch briefly.
The roller blind moves to its final position.
Touch the rocker switch again to stop in any position.

Closing the roller blind to the desired position

- f Push the rocker switch and hold it until the roller blind has reached the desired position.

Closing the roller blind fully (one-touch operation)

- f Push the rocker switch briefly.
The roller blind moves to its final position.
Touch the rocker switch again to stop in any position.



Sliding glass roof

Readiness for operation

- With ignition switched on (engine on or off) **or**
- When door is closed and ignition key withdrawn, but only until door is first opened.
- The glass rear hatch must be closed.

Opening sliding glass roof



Warning!

Risk of injury and damage.

- f Before opening the sliding glass roof, ensure that there are no persons or objects in the range of movement.
- f Push the rocker switch and hold it until the sliding glass roof has reached the desired position.

Closing the sliding glass roof

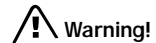

Warning!

Risk of injury and damage.

- f Before closing the sliding glass roof, ensure that there are no persons or objects in the range of movement.
- f Pull the rocker switch and hold it until the sliding glass roof is closed and completely raised.



Glass rear hatch

Opening the glass rear hatch

The sliding glass roof must be closed.

- f To unlock it, operate the pull-button **A** beside the driver's seat, **or**
- f push the button for the glass rear hatch on the remote control.
- f Please see the chapter "KEY WITH RADIO REMOTE CONTROL" on Page 16.
- f Lift glass rear hatch.

The interior light is switched on when the glass rear hatch is unlocked.

Closing glass rear hatch

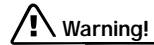

Risk of pinching. The glass rear hatch is automatically pulled into the lock and locked.

- f Ensure that your fingers are not caught under the glass rear hatch.
- f Place your hand on the glass rear hatch.
- f Lower the glass rear hatch until it is automatically closed and locked.

Message in on-board computer

Glass rear hatch

A message appears on the on-board computer if the glass rear hatch is not completely closed.

- f Fully close the glass rear hatch.

Emergency operation of sliding glass roof

Closing the sliding glass roof

- f Before using emergency operation, please check whether the fuses may be defective.
- f Please see the chapter "ELECTRICAL SYSTEM" on Page 257.



Risk of injury and damage.

- f Do not operate the sliding glass roof with the rocker switch during and after emergency operation.

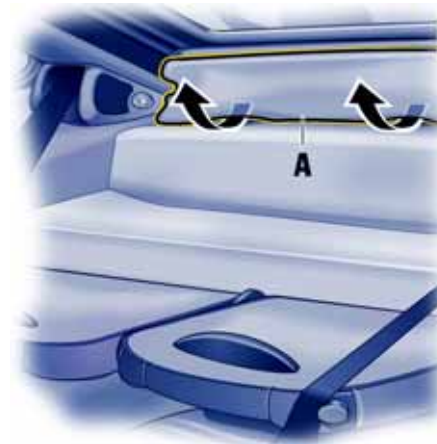

1. Remove ignition key.
2. Move the front passenger seat forward and fold the backrest forward. Fold the rear seat backrests forward.
3. Grasp under the rear-wall lining **A** with your hands. Forcefully pull the rear-wall lining **A** forward.

881-245

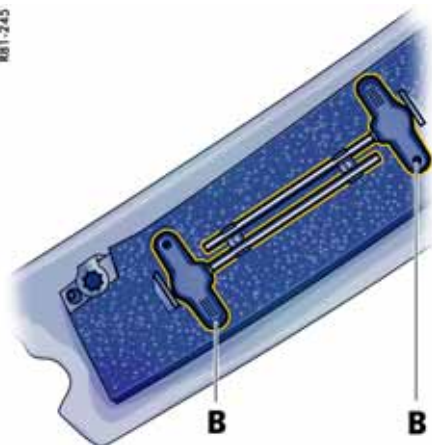

You will find the Allen keys for emergency operation on the back on the lining **A**.

4. Take both Allen keys **B** out of their holder.

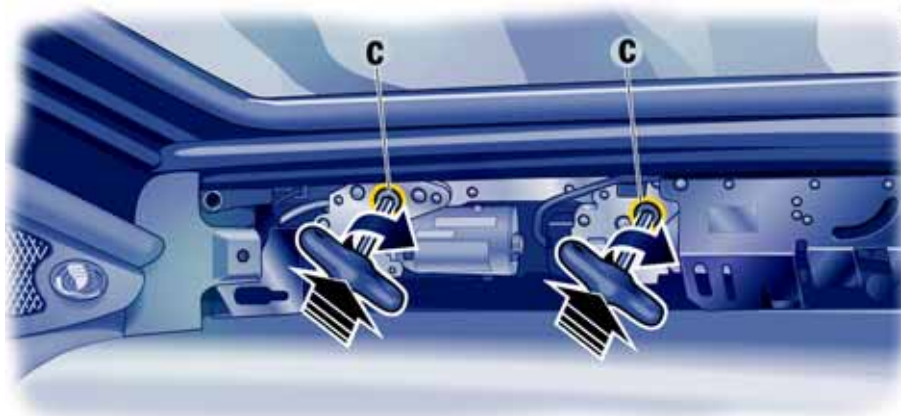

881-243

5. Insert the Allen keys into the drive axles **C** of the electric motors.

6. Press both Allen keys into the drive axles until they engage audibly. This requires a somewhat greater effort.

7. Keep both Allen keys pressed in and turn them to the right. Keep turning until the sliding roof is closed.

8. Remove the Allen keys. Close the rear-wall lining.

9. Please have the fault remedied at an authorized Porsche dealer.

Roof Transport System

(Coupé only)

- f Please follow the separate instructions for fitting the Roof Transport System.
- f Only use Roof Transport Systems from the Porsche Tequipment product range or Roof Transport Systems which have been tested and approved for your car by Porsche. Fitting normal commercially available luggage racks is not possible.

The **Porsche Roof Transport System** allows you to carry various sports and hobby equipment. Your authorized Porsche dealer will be pleased to tell you about the various different uses of the Roof Transport System.

Safety notes!

- f Completely remove the Roof Transport System before using an automatic car wash – risk of damage to the vehicle!
- f Do not exceed the maximum permitted payload, the maximum permitted gross weight and the maximum permitted axle loads. Please see the chapter “WEIGHTS COUPÉ” on Page 291.
- f Distribute load evenly, with heavy items as low as possible. Items of luggage must not project beyond the side of the load area.
- f Fix and secure every item to the basic carrier with a rope or lashing strap (do not use elastic rubber tensioners).
- f Before every journey, and at regular intervals during long trips, check that Roof Transport System and load are secure. Re-tighten if necessary and secure additionally by locking.

When the Roof Transport System is loaded, the maximum speed depends on the nature, size and weight of the load being carried.

Driving, braking and steering behavior change due to the higher center of gravity and the greater wind-resistant area. You should adapt your driving style appropriately.

Since fuel consumption and noise are increased with the Roof Transport System fitted, it should not remain on the vehicle if not in use.

Maintenance, Car Care

Exercise Extreme Caution when Working on your Vehicle	206
Coolant Level	207
Engine Oil	208
Engine Oil Level	208
Engine Oil Recommendation	210
Brake Fluid Level	212
Fuel Economy	214
Operating your Porsche in other Countries ..	214
Fuel Recommendations	216
Portable Fuel Containers	217
Fuel Evaporation Control	217
Emission Control System	218
How Emission Control Works	219
Washer Fluid	220
Power Steering	221
Air Filter	222
Combination Filter	222
Fluids/Oils for Manual Transmission and Porsche Doppelkupplung (PDK)	222
Wiper Blades	223
Car Care Instructions	224

Exercise Extreme Caution when Working on your Vehicle



Danger!

Ignoring the following instructions may cause serious personal injury or death.

- f The engine compartment of any motor vehicle is a potentially hazardous area. If you are not fully familiar with proper repair procedures, do not attempt the adjustments described on the following pages.
This caution also applies to the entire vehicle.
- f Only work on your vehicle outdoors or in a well ventilated area.
- f Ensure that there are no open flames in the area of your vehicle at any time when fuel fumes might be present. Be especially cautious of such devices such as hot water heaters which ignite a flame intermittently.
- f Before working on any part in the engine compartment, turn the engine off and let it cool down sufficiently. Hot engine compartment components can burn skin on contact.
- f Be alert and cautious around engine at all times while the engine is running.
If work has to be performed with the engine running, always set the parking brake, and make sure the shift lever is in neutral position or the PDK selector lever in position **P** or **N**.
- f In particular, be very careful to ensure that items of clothing (ties, shirt, sleeves etc.), jewelry, long hair, hand or fingers cannot get caught in the engine-compartment blower, fan, belts or other moving parts.
The radiator and radiator fans are in the front of the car.
The engine-compartment blower is mounted on the engine-compartment lid.
The engine-compartment blower can start or continue running as a function of temperature, even with the engine switched off.
Carry out work in these areas only with the engine off, the ignition switched off, and exercise extreme caution.
- f Your Porsche is equipped with an electronic ignition system. When the ignition is on, high voltage is present in all wires connected with the ignition system; therefore, exercise extreme caution when working on any part of the engine while the ignition is on or the engine is running.
- f Always support your car with safety stands if it is necessary to work under the car.
- f When working under the car without safety stands but with the wheels on the ground, make sure the car is on level ground, the wheels are blocked, and that the engine cannot be started.
Remove the ignition key.
- f Do not smoke or allow an open flame around the battery or fuel.
Keep a fire extinguisher in close reach.
- f Incomplete or improper servicing may cause problems in the operation of the car. If in doubt about any servicing, have it done by your authorized Porsche dealer.
Improper maintenance during the warranty period may affect your Porsche warranty coverage.
- f Supplies of fluids, e.g. engine oil, brake fluid or coolant, are hazardous to your health.
Keep these fluids out of children's reach and dispose of them in accordance with the appropriate regulations.
- f Some countries require additional tools and special spare parts to be carried in your vehicle.
Please make enquiries before driving abroad.



Coolant Level

- f Please see the chapter "EXERCISE EXTREME CAUTION WHEN WORKING ON YOUR VEHICLE" on Page 206.

The cooling system is filled at the factory with a permanent coolant. It provides year-round protection from corrosion and freezing down to $-31^{\circ}\text{F}/-35^{\circ}\text{C}$.

- f Only use antifreeze authorized by Porsche.

Checking coolant level

The expansion tank with its filler orifice is in the engine compartment.

- f Check the coolant level regularly through the transparent expansion tank.

When the engine is cold and the car is level the fluid level must lie between the "MIN" and "MAX" markings.

Topping off coolant

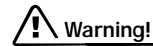

Warning!

Danger of serious personal injury or death from scalding. Coolant is hazardous to your health, and may be fatal if swallowed.

- f Do not open the cap of the expansion tank while the engine is hot.
- f Allow the engine to cool down before opening the cap and protect your hands, arms and face from any possible escape of hot coolant.
- f Keep coolant out of children's reach.
- f Also, keep coolant away from your pets. They can be attracted to it should there be a spill, or to used coolant left in an open container. Coolant can be deadly to pets if consumed.

1. Switch engine off and let it cool. Please see the chapter "COOLING SYSTEM" on Page 120.
2. Cover the expansion tank cap with a thick rag. Open cap slowly and carefully and allow overpressure to escape. Then unscrew cap completely.
3. Only add a mixture of antifreeze and water in equal parts, and do not exceed the "MAX" mark.

Antifreeze in coolant:

50% gives protection down to $-31^{\circ}\text{F}/-35^{\circ}\text{C}$
 60% gives protection down to $-58^{\circ}\text{F}/-50^{\circ}\text{C}$

4. Screw cap firmly on.

If in an emergency pure water has been added, the mix ratio must be corrected at an authorized Porsche dealer.

Marked loss of coolant indicates leakage in the cooling system. The cause should immediately be remedied at an authorized Porsche dealer.

Engine-compartment blower, radiator fan

The radiator and radiator fans are in the front of the car.

The engine-compartment blower is mounted on the engine compartment lid.



Warning!

Risk of injury.

After the engine is switched off, the engine-compartment temperature is monitored for approx. 30 minutes.

During this period, and depending on temperature, the engine-compartment blower may continue to run or start to run.

- f Carry out work in these areas only with the engine off, the ignition off, and exercise extreme caution.

Risk of injury. The radiator fans in the front end of the car may be operating or unexpectedly start operating when the engine is switched on.

- f Carry out work in these areas only with the engine switched off.

Engine Oil

It is important to perform oil changes regularly in accordance with the intervals specified in the "Maintenance" booklet.

Engine oil consumption

It is normal for your engine to consume oil. The rate of oil consumption depends on the quality and viscosity of oil, the speed at which the engine is operated, the climate, road conditions as well as the amount of dilution and oxidation of the lubricant.

If the vehicle is used for repeated short trips, and consumes a normal amount of oil, the engine oil measurement may not show any drop in the oil level at all, even after 600 miles (1,000 km) or more. This is because the oil is gradually becoming diluted with fuel or moisture, making it appear that the oil level has not changed.

The diluting ingredients evaporate out when the vehicle is driven at high speeds, as on an expressway, making it then appear that oil is excessively consumed after driving at high speeds.

If the conditions you drive your vehicle in are dusty, humid, or hot, the frequency of the oil change intervals should be greater.

If the vehicle is driven at a high rate of speed, climatic conditions are warm, and the load is high, the oil should be checked more frequently, as driving conditions will determine the rate of oil consumption.

- The engine in your vehicle depends on oil to lubricate and cool all of its moving parts. Therefore, the engine oil should be checked regularly and kept at the required level.
- Make it a habit to have the engine oil level checked at every fuel filling.
- The oil pressure warning light is not an oil level indicator. The oil pressure warning light indicates serious engine damage may be occurring when lit, if engine rpm is above idle speed.

Engine Oil Level

- f Please see the chapter "EXERCISE EXTREME CAUTION WHEN WORKING ON YOUR VEHICLE" on Page 206.
- f Regularly check the oil level using the on-board computer after the vehicle is refuelled. Please see the chapter "OIL DISPLAY AND MEASUREMENT OF THE ENGINE OIL LEVEL" on Page 153.

The difference between the minimum and maximum marks on the segment display is approx. 1.3 quarts (1.25 liters). Each segment of the display corresponds to approx. 0.42 quart (0.4 liter).

Topping off engine oil

Warning!

Risk of burning from hot parts in engine compartment. Risk of injury by rotating parts. The engine compartment blower on the engine compartment lid can start up even with engine off.

f Exercise extreme caution when working in the engine compartment.

f Top off engine oil only with the engine off.

Engine oil is hazardous to your health and may be fatal if swallowed.

f Keep engine oil out of children's reach.

Used engine oil contains chemicals that have caused cancer in laboratory animals.

f Always protect your skin by washing thoroughly with soap and water.

Note

The Check Engine warning light may light up if the cap of the oil filler opening is opened while the engine is running.



1. Measure the oil level and read off the required top-up quantity on the on-board computer.
2. Switch off the engine.
3. Turn the oil filler cap counter-clockwise by approx. 90 ° and fully pull out the oil filler tube by means of the cap.
4. Fold down the oil filler cap.
5. Add at most 0.5 quarts (0.5 liter) of engine oil at a time.
Never add more engine oil than required to reach the max. mark.
6. Fold up oil filler cap.
7. Push in oil filler tube fully and turn cap clockwise until you feel it reach its end position.
8. Measure oil level again with the on-board computer. Switch off the engine.
9. If necessary, repeat the process and add more engine oil as required.

Engine Oil Recommendation

Porsche recommends .

The right oil for your vehicle.

Complies with approval ¹⁾	Viscosity class ²⁾
Porsche A40	SAE 0W - 40 ³⁾ SAE 5W - 40 ⁴⁾ SAE 5W - 50 ⁴⁾

¹⁾ Generally, you can find details of the manufacturer approvals on the oil containers or as a notice displayed by the retailer. The current approval status is also available from your Porsche partner.

²⁾ SAE viscosity class - Example: SAE 0W - 40
Specification 0W = Viscosity specification for low temperatures (winter).
Specification 40 = Viscosity specification for high temperatures.

³⁾ For all temperature ranges.

⁴⁾ For the temperature range over -13 °F (-25 °C).

Always observe the following points:

- Use engine oils approved by Porsche only. This is a precondition for optimum and problem-free operation of your vehicle.
- Regular oil changes are part of servicing. It is important that the service intervals, particularly the oil change intervals, are observed in accordance with the specifications in the "Maintenance" booklet.
- Oils approved by Porsche can be mixed with each other.
- Porsche engines are designed so that no oil additives may be used.
- A label is located in the engine compartment, which provides you with information on suitable oil for your engine.

Your Porsche partner will be pleased to advise you.

Oil change

The engine oil has to be changed regularly at the intervals listed in your **Maintenance Schedule**.

f Please see the chapter "CAPACITIES" on Page 290.

We recommend that you have the engine oil changed at your Porsche dealer, who has the required oils and the necessary filling equipment.

If you suspect an oil leak in the engine have your dealer check it out immediately.

All current engine oils are compatible with each other, i.e. when making an oil change it is not necessary to flush the engine if you wish to use a different brand or grade of oil.

Since, however, each brand of oil has a special composition, you should, if possible, use the same oil brand if it becomes necessary to top up between oil changes.

Porsche engines have long intervals between oil changes. You can make best use of these long oil change intervals by using multigrade oils since these are largely independent of seasonal fluctuations in temperature.

If your vehicle is used frequently in stop-and-go traffic in cold weather, the engine will not always be properly warmed up. Condensation from products of combustion may accumulate in the oil. In this case, it is advisable to change the oil more frequently so that your engine once again has 100% efficient engine oil.

Engine oil performance class

Engine oil is not only a lubricant, but also serves to keep the engine clean, to neutralize the dirt which penetrates into the engine through combustion and to protect the engine against corrosion. To perform these functions, the oil is provided with additives which have been specially developed for these functions.

The efficiency of an oil is expressed, for example, by the API, ILSAC or ACEA classifications.

Viscosity

Like all liquids, engine oil is viscous when cold, and thin-bodied when warm. The viscosity of an oil is expressed by its SAE class. For cold viscosity (measured at temperatures below 32 °F/0 °C) the SAE class is given as a number and the letter "W" (as in winter), for hot viscosity (measured at 212 °F/100 °C) the SAE class is given only as a number.

The viscosity of an oil is, therefore, always the same if it has the same number of an SAE class.

Oils with two viscosities are called multigrade oils; oils with only one viscosity are termed single-grade oils.

Single-grade oils can not be used in your engine.

The viscosity of the engine oil for your Porsche has to be chosen according to the ambient temperature given in the engine oil recommendation table.

Brake Fluid Level

f Please see the chapter "EXERCISE EXTREME CAUTION WHEN WORKING ON YOUR VEHICLE" on Page 206.

f Use only new (unused) Original Porsche brake fluid.

Warning!

Brake fluid is hazardous to your health, and may be fatal if swallowed.

Brake fluid also attacks paintwork.

f Keep brake fluid out of children's reach.

f Take care while topping off brake fluid not to soil the luggage compartment or items of luggage.

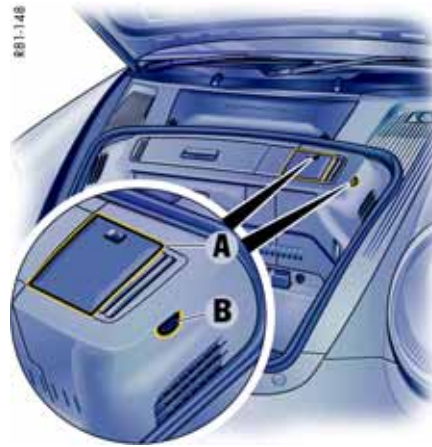

Example: 911 Carrera, 911 Carrera S

Checking the brake fluid level

The reservoir for the hydraulic braking and clutch systems is located in the luggage compartment.

1. Open and remove cover flap **A**.
2. Regularly check the brake-fluid level on the transparent expansion tank through the window **B**.

The fluid level should always lie between the minimum and maximum marks.



A slight decrease in the fluid level due to wear and automatic readjustment of the disc brakes is normal.

If, however, the fluid level falls markedly or below the minimum mark, the braking system may have developed a leak.

f Have the brake system checked without delay at an authorized Porsche dealer.

Changing the brake fluid

Brake fluid absorbs moisture from the air over time. This accumulation of water lowers the boiling point and, under certain operating conditions, can affect the braking performance. Therefore have the brake fluid changed in accordance with the change intervals stated in the brochure "Maintenance".

Warning light USA

Warning light Canada

- The warning lights on the instrument panel and on the on-board computer indicate an insufficient brake fluid level.
- If the warning light lights up on the instrument panel and the warning message appears on the on-board computer in combination with a larger pedal travel, a brake circuit may have failed.

If the warning lights should light up when driving:

- f Stop immediately in a suitable place.
- f Do not continue driving.
Consult an authorized Porsche dealer.

Fuel Economy

Fuel economy will vary depending on where, when and how you drive, optional equipment installed, and the general condition of your car.

A car tuned to specifications and correctly maintained, will help you to achieve optimal fuel economy.

- f Have your vehicle tuned to specifications.
 - Air cleaner should be dirt free to allow proper engine "breathing".
 - Battery should be fully charged.
 - Wheels should be properly aligned.
 - Tires should be inflated at correct pressure.
- f Always monitor your fuel consumption.
- f Drive smoothly, avoid abrupt changes in speed as much as possible.
- f Avoid jack rabbit starts and sudden stops.
- f Do not drive longer than necessary in the lower gears. Shifting into a higher gear early without lugging the engine will help save fuel.
- f Prolonged "warm up" idling wastes gas. Start the vehicle just before you are ready to drive. Accelerate slowly and smoothly.
- f Switch off the engine if stationary for longer periods.

- f Any additional weight carried in the vehicle reduces fuel economy. Always keep cargo to a minimum and remove all unnecessary items.
- f Organize your trips to take in several errands in one trip.
- f All electrical accessories contribute to increased fuel consumption.
- f Only switch on the air conditioning when necessary.
- f Do not drive with the Roof Transport System mounted unless you need it.

The EPA estimated mpg. is to be used for comparison purposes, actual mileage may be different from the estimated mpg., depending on your driving speed, weather conditions and trip length. Your actual highway mileage will probably be less than the estimated mpg.

- f Please observe all local and national speed limits.

Operating your Porsche in other Countries

Government regulations in the United States and Canada require that automobiles meet specific emission regulations and safety standards. Therefore, cars built for the U.S. and Canada differ from vehicles sold in other countries.

If you plan to take your Porsche outside the continental limits of the United States or Canada, there is the possibility that

- unleaded fuel may not be available;
- unleaded fuel may have a considerably lower octane rating. Excessive engine knock and serious damage to both engine and catalytic converters could result;
- service may be inadequate due to lack of proper service facilities, tools or diagnostic equipment;
- replacement parts may not be available or very difficult to get.

Porsche cannot be responsible for the mechanical damage that could result because of inadequate fuel, service or parts availability.

If you purchased your Porsche abroad and want to bring it back home, be sure to find out about shipping and forwarding requirements, as well as current import and customs regulations.

Fuel

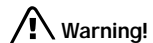

Warning!

Fuel is highly flammable and harmful to health.

- f Fire, open flame and smoking are prohibited when handling fuel.
- f Avoid contact with skin or clothing.
- f Do not inhale fuel vapors.

To prevent damage to the emission control system and engine:

- f Never drive the tank completely out of fuel.
- f Avoid high cornering speeds after the warning lights have come on.

-
- f Please see the chapter "FUEL ECONOMY" on Page 214.
Please see the chapter "EMISSION CONTROL SYSTEM" on Page 218.
Please see the chapter "LEVEL GAGE" on Page 122.

Check engine warning light

If the warning lights in the instrument panel and on-board computer come on and remain on while driving, it suggests:

- a potential engine control problem and the need for system service **or**
- an improperly fastened tank cap **or**



- refueling with engine running.

Opening the filler flap

The filler opening is under the filler flap in the front right fender.

- f With the vehicle unlocked, press on the front part of the filler flap (**arrow**) to open the flap.

The filler flap is centrally locked along with the other locks.

If there is a defect in the automatic unlocking system:

- f Open the passenger door.
- f Pull the ring in the right-hand door aperture (**arrow**).



Refueling

Fuel tank capacity is listed under "Capacities". Porsche does not recommend the use of fuel additives.

Fuel is highly flammable and harmful to health.

f Please see the chapter "CAPACITIES" on Page 290.

1. **Important:** Stop the engine and switch off the ignition.
2. Slowly unscrew the tank cap. Hang the tank cap's plastic strap on the hook on the inside wall of the filler flap.
3. Insert fuel-hose nozzle fully into the filler neck with the handle of the fuel-hose nozzle facing down.
4. Do not add further fuel once the correctly operated automatic fuel-hose nozzle has switched off. Fuel could spray or could run over in warm temperatures.
5. Replace the tank cap immediately after refueling and turn it until you hear it and feel it engage.

If you lose the tank cap, you must replace it only with an original part to reduce the possibility of a fire in the event of a collision.

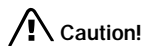

Risk of damage. Decorative film may fade if it comes into contact with fuel.

f Wipe off any emerging fuel immediately.

Fuel Recommendations

Your Porsche is equipped with catalytic converters and must use **UNLEADED FUEL ONLY**.

Your engine is designed to provide optimum performance and fuel economy using unleaded premium fuel with an octane rating of **98 RON (93 CLC or AKI)**. Porsche therefore recommends the use of these fuels in your vehicle.

Porsche also recognizes that these fuels may not always be available. Be assured that your vehicle will operate properly on unleaded premium fuels with octane numbers of at least **95 RON (90 CLC or AKI)**, since the engine's "Electronic Oktane™ knock control" will adapt the ignition timing, if necessary.

It is important to observe the regular service intervals, and particularly the oil change intervals, specified in the "Maintenance" booklet.

The use of UNLEADED FUEL ONLY is critically important to the life of the catalytic converters. Deposits from leaded fuels will ruin the converters and make it ineffective as an emission control device.

Cars with catalytic converters have a smaller fuel tank opening, and gas station pumps have smaller nozzles. This will prevent accidental pumping of leaded fuel into cars with catalytic converters.

Unleaded fuels may not be available outside the continental U.S. and Canada. Therefore, we recommend you do not take your car to areas or countries where unleaded fuel may not be available.

Octane ratings

Octane rating indicates a fuel's ability to resist detonation. Therefore, buying the correct octane gas is important to prevent engine "damage".

The RON octane rating is based on the research method. The CLC (U.S. Cost of Living Council octane rating) or AKI (antiknock index) octane rating usually displayed on U.S. fuel pumps is calculated as research octane number plus motor octane number, divided by 2, that is written as:

$$\frac{\text{RON} + \text{MON}}{2} \quad \text{or} \quad \frac{\text{R} + \text{M}}{2}$$

The CLC or AKI octane rating is usually lower than the RON rating:

For example: 95 RON equals 90 CLC or AKI

Fuels containing ethanol

Do not use any fuels containing more than 10 percent ethanol by volume.

We recommend, however, to change to a different fuel or station if any of the following problems occur with your vehicle:

- Deterioration of driveability and performance.
- Substantially reduced fuel economy.
- Vapor lock and non-start problems, especially at high altitude or at high temperature.
- Engine malfunction or stalling.

Portable Fuel Containers



Portable fuel containers, full or partially empty, may leak causing an explosion, or result in fire in case of an accident.

- f Never carry additional fuel in portable containers in your vehicle.

Fuel Evaporation Control

Fuel tank venting

The evaporation chamber and the carbon canister prevent fuel from escaping to the atmosphere at extreme high outside temperatures, when driving abruptly around curves and when the car is parked at an incline or in any other nonlevel position.

Vapor control system and storage

When the fuel tank is filled, vapors are collected in the evaporation chamber by a vent line leading the vapors to the carbon canister where they are stored as long as the engine does not run.

Purge system

When the engine is running, the fuel vapors from the canister will be mixed with fresh air from the ambient air of the canister. This mixture will be directed to the intake air housing by the tank vent line, mixed with the intake air and burned during normal combustion.

Emission Control System

In the interest of clean air

Pollution of our environment has become a problem that is of increasing concern to all of us. We urge you to join us in our efforts for cleaner air in controlling the pollutants emitted from the automobile.

Porsche has developed an emission control system that controls or reduces those parts of the emission that can be harmful to our environment. Your Porsche is equipped with such a system.

Porsche warrants the Emission Control System in your new car under the terms and conditions set forth in the Warranty Booklet.

You, as the owner of the vehicle, have the responsibility to provide regular maintenance service for the vehicle and to keep a record of all maintenance work performed. To facilitate record keeping, have the service performed by authorized Porsche dealers. They have Porsche trained technicians and special tools to provide fast and efficient service.

To assure efficient operation of the Emission Control System:

- f Have your vehicle maintained properly and in accordance with the recommendations described in your Maintenance Booklet. Lack of proper maintenance, as well as improper use of the vehicle, will impair the function of the emission control system and could lead to damage.
- f Do not alter or remove any component of the emission control system.
- f Do not alter or remove any device, such as heat shields, switches, ignition wires, valves, etc., which are designed to protect your vehicle's emission control system. In addition to serious engine damage, this can result in a fire if excess raw fuel reaches the exhaust system.
- f Do not continue to operate your vehicle if you detect engine misfire or other unusual operating conditions.

Parking

Warning!

Danger of fire resulting in serious personal injury or death.

- f Do not park or operate the vehicle in areas where the hot exhaust system may come in contact with dry grass, brush, fuel spill or other flammable material.
 - f If your car catches on fire for any reason, call the fire department. Do not endanger your life by attempting to put out the fire.
-

Undercoating

Danger!

Danger of fire resulting in serious personal injury or death.

- f Do not apply additional undercoating or rust-proofing on or near the exhaust manifold, exhaust pipes, catalytic converters or heat shields. During driving the substance used for undercoating could overheat and ignite.
-

How Emission Control Works

When an automobile engine is running, it uses energy generated through the combustion of a mixture of air and fuel. Depending on whether a car is driven fast or slowly or whether the engine is cold or hot, some of the fuel (hydrocarbons) may not be burned completely, but may be discharged into the engine crankcase or exhaust system. Additional hydrocarbons may enter the atmosphere through evaporation of fuel from the fuel tank. These hydrocarbons (HC), when released into the air, contribute to undesirable pollution.

In addition, carbon monoxide (CO) and oxides of nitrogen (NOx) contribute to engine emissions. They, too, are formed during the combustion process and discharged into the exhaust system.

To reduce these pollutants, your Porsche is equipped with a precisely calibrated fuel injection system to assure a finely balanced air/fuel mixture under all operating conditions.

Oxygen sensor

The oxygen sensor, installed in the exhaust pipe continuously senses the oxygen content of the exhaust and signals the information to an electronic control unit. The control unit corrects the air/fuel ratio, so the engine always receives an accurately metered air/fuel mixture.

Crankcase ventilation

Through crankcase ventilation, undesirable emissions from the engine crankcase are not permitted to reach the outside atmosphere. These emissions are recirculated from the crankcase to the air intake system. From here the emissions mix with the intake air and are later burned in the engine.

Catalytic converters

The catalytic converters are efficient "clean-up" devices built into the exhaust system of the vehicle. The catalytic converters burn the undesirable pollutants in the exhaust gas before it is released into the atmosphere.

The exclusive use of unleaded fuel is critically important for the life of the catalytic converters. Therefore, only unleaded fuel must be used.

The catalytic converters will be damaged by:

- push or tow starting the vehicle
 - misfiring of the engine
 - turning off the ignition while the vehicle is moving or
 - driving until the fuel tank is completely empty
 - by other unusual operating conditions.
- f Do not continue to operate your vehicle under these conditions, since raw fuel might reach the catalytic converters. This could result in overheating of the converters. Federal law prohibits use of leaded fuel in this car.



Washer Fluid

Capacity: Approximately 6.3 quarts (6.0 liters).

Washer fluid

The reservoir, with a blue screw cap, is in the front luggage compartment, to the rear left.

Clean water is generally not enough to clean the windshield and headlights. Depending on the season, mix the water with the appropriate additives. Follow the instructions for the mixture ratio.

Only use window cleaner concentrate which meets the following requirements.

- Dilutability 1:100
- Phosphate-free
- Suitable for plastic headlight lenses.

We recommend window cleaner concentrates approved by Porsche. Your authorized Porsche dealer will be pleased to advise you.

Summer filling

Water + window cleaner concentrate at the mixing ratio indicated on the container.

Winter filling

Water + antifreeze protection + window cleaner concentrate at the mixing ratio indicated on the container.

- f Please note all the information on the containers of the window cleaner concentrate or the antifreeze protection.

Topping off washer fluid

1. Please note all the information on the refill container of the cleaning agent.
 2. Open cap of the washer-fluid reservoir (arrow).
 3. Top up washer fluid and close cap properly.
- f Do not use engine coolant anti-freeze or any other solution that can damage the car's paint, in the washer reservoir.



Warning light

If less than 0.53 quarts (0.5 liter) remains, a warning message appears on the on-board computer.

- f Add washer fluid.



Power Steering

Power steering is assisted by hydraulic auxiliary forces.

The hydraulic fluid reservoir is located in the engine compartment.

Note

The flow noise heard at full steering lock is design-related and does not indicate a defect in the steering system.

Warning!

Risk of accident resulting in serious personal injury or death.

When the engine is stopped (e.g. when being towed) or the hydraulic system fails, there is no assistance for steering. Therefore, substantially more force will have to be exerted in order to steer.

- f Exercise great care when being towed.
- f Have the fault remedied at your nearest authorized Porsche dealer.

Checking hydraulic fluid

- f Please see the chapter "EXERCISE EXTREME CAUTION WHEN WORKING ON YOUR VEHICLE" on Page 206.
- f Only use hydraulic fluid authorized by Porsche. Specification: Please see the chapter "CAPACITIES" on Page 290.

Check the fluid level with the engine stopped and **cold** (approximately 68 °F/20 °C).

1. Open the engine compartment lid.
2. Open the reservoir cap.
3. Wipe measuring rod.
Close cap and reopen. The fluid level should lie between the "MIN" and "MAX" marks.
Add hydraulic fluid if necessary.
4. Close cap carefully.
Close engine compartment lid.

Noticeable loss of fluid indicates leakage in the system.

The cause should be remedied immediately at an authorized Porsche dealer.

Air Filter

A dirty air filter not only reduces engine performance, but can lead to premature engine wear.

Regular filter replacement is part of the routine maintenance service.

- f In dusty conditions, check the filter element more frequently and replace if necessary.

Combination Filter

The fresh air passing through the combination filter into the passenger compartment is virtually free of dust, pollen, and unpleasant odors.

- f If the outside air is polluted by exhaust fumes, press the circulating-air button.

A dirty filter can be the cause of reduced air flow:

- f Have filter replaced by your authorized Porsche dealer.

Regular filter replacement is part of the routine maintenance service.

Fluids/Oils for Manual Transmission and Porsche Doppelkupplung (PDK)

The transmission fluids/oils have to be checked and changed at the intervals listed in your Maintenance Schedule.

- f Please see the chapter "CAPACITIES" on Page 290.

Do not tow the car or run the engine without fluid/oil in the transmission. The transmission may be damaged by even a tiny speck of dirt, only a clean funnel or spout must be used when adding fluid/oil.

We recommend that you have the fluids/oils changed at your Porsche dealer, who has the required lubricants and the necessary filling equipment.

- f If you suspect an oil leak in the transmission, have your authorized Porsche dealer check it out immediately.

Wiper Blades

Wiper blades that are in perfect condition are vital for a clear view.

- f Replace the wiper blades twice per year (before and after the cold season) or whenever wiper performance deteriorates.



Caution!

Risk of damage if the wiper arm accidentally falls back on to the window.

- f Always hold the wiper arm securely when replacing the wiper blade.

Risk of damage if wiper blades that are frozen in place are loosened improperly.

- f Thaw the wiper blades before loosening them.
-

Maintenance note

- f Periodically clean the wiper blades with window cleaner, especially after the vehicle has been washed in a car wash.
We recommend the Porsche window cleaner. If they are very dirty (e.g. with insect remains), they can be cleaned with a sponge or cloth.

If the wiper blades rub or squeak, this can be as a result of the following:

- If the vehicle is washed in an automatic car wash, wax residues may adhere to the windshield. These wax residues can be removed only by using window cleaner concentrate.
- The wiper blades may be damaged or worn.
- f Replace damaged or worn wiper blades as soon as possible.
- f Please see the chapter "WASHER FLUID" on Page 220.
- f Please contact your authorized Porsche dealer for further information.

Changing windshield wiper blades

- f Please read the separate instructions for fitting wiper blades as supplied by the manufacturer.
- f We recommend that you get your authorized Porsche dealer to replace the wiper blades.



Caution!

Risk of damage.

If the wiper blades are not changed properly, they can come loose when the car is moving.

- f Check that the wiper blades are seated securely. The wiper blades must engage properly in the wiper arm.
-

Car Care Instructions

- f Please see the chapter "EXERCISE EXTREME CAUTION WHEN WORKING ON YOUR VEHICLE" on Page 206.

Regular and correct care helps to maintain the value of your car and is also a precondition for the New Vehicle Warranty and the Anti Corrosion Warranty.

Your authorized Porsche dealer has specially developed car-care products from the Porsche program available either singly or as complete car-care sets. They will be pleased to help you select suitable products.

Whether you use Porsche products or other commercially available cleaning agents first make sure of their correct application.

A Porsche that is well-cared for can look like new for years. It all depends on the amount of care the owner is willing to give the car.

Warning!

Risk of serious personal injury or damage to the vehicle or property.

Cleaning agents may be hazardous to your health.

Most chemical cleaners are concentrates which require dilution. High concentrations might cause problems ranging from irritation to serious injury as well as damage to your vehicle.

- f Keep cleaning agents out of reach from children.
- f Observe all caution labels.
- f Always read directions on the container before using any product. These directions may contain information necessary to avoid personal injury.
- f Do not use fuel, kerosene, naphtha, nail polish remover or other volatile cleaning fluids. They may be toxic, flammable or hazardous in other ways. Only use spot removing fluids in a well vented area.
- f Do not clean the underside of chassis, fenders, wheel covers, etc., without protecting your hands and arms as you may cut yourself on sharp-edged metal parts.

Moisture and road salt on brakes may affect braking efficiency.

- f Test the brakes after each vehicle washing.

Decorative film

Caution!

Risk of damage due to separation of the decorative film when cleaning your vehicle with high-pressure cleaning equipment or steam cleaners.

- f Do not use high-pressure cleaning equipment or steam cleaners for cleaning decorative film.

High-pressure cleaning units, steam cleaners

Warning!

High-pressure cleaning units or steam cleaners can damage the following components:

- tires,
- logos, emblems,
- painted surfaces,
- alternator,
- ParkAssist sensors.
- f Please observe the operating instructions from the unit manufacturer.
- f When cleaning with a flat-jet nozzle or the like, maintain a minimum distance of 20 inches (50 cm).
- f Never use high-pressure cleaning units or steam cleaners with a round-jet nozzle. A high-pressure cleaning unit or steam cleaner with round nozzle will damage your vehicle.
- f The tires are particularly susceptible to damage.
- f Do not point the cleaning jet directly at any of the aforementioned components.

Washing

The best method of protecting your car from the damaging effects of the environment is frequent washing and the application of a preservative. The underside of your vehicle should also be thoroughly washed for cinders, salt or sanding at winter's end.

The longer salt, road dust and industrial dust, dead insects, bird droppings or substances from trees (resin, pollen) are allowed to remain on the bodywork, the more serious is their harmful effect.

New cars should be washed carefully with plenty of clear water to protect the new paint work. Dark paint finishes show up the smallest of surface damage (e.g., scratches) more readily than lighter colors.

Dark colors are also more susceptible to scratching because of the composition of their pigments and require particularly careful paint care.

- f Do not wash your car in bright sunlight or while the bodywork is still hot.
- f When washing by hand, use abundant water, a soft sponge or wash brush, and Porsche car shampoo.
- f Begin by spraying the body thoroughly with water to rinse away loose dirt.

- f After washing, rinse the car with plenty of water and then dry with a chamois leather. Do not use the same chamois leather for drying as you use for cleaning the windshield and windows.

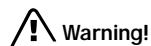

Moisture which gets on to the brakes during a car wash can reduce braking efficiency or make the brakes pull unevenly which could increase the danger of an accident, causing serious personal injuries or death.

- f After washing the car, test the brakes and steering and briefly brake the discs dry. When doing this, take care not to hamper other road users behind you (traffic conditions permitting).

Automatic car washes

- f Please see the chapter "WIPER BLADES" on Page 223.

Optional add-on parts or parts which project beyond the contours of the vehicle may be damaged by design features (e.g. brushes) of automatic car washes.

The following parts are particularly susceptible to damage:

- Convertible top (hot wax treatment cannot be used, as the wax attacks the convertible top material)
 - Windshield wipers (always switch them off to prevent them wiping unintentionally in intermittent or sensor operation)
 - External antennas (always unscrew)
 - Roof Transport System (always remove completely)
 - Rear spoiler
 - Wheels (the wider the rim and the lower the tire height, the greater the risk of damage)
 - High-gloss wheels (to prevent these from getting scratched, do not clean with the wheel-cleaning brushes of the car wash).
- f Please consult the operator before using automatic car washes.
 - f Wash and dry by hand all points not reached by a car wash, such as door and lid seams or door sills.

Note

Automatic car washes spray water at odd angles and high pressures, which are not seen in normal driving. Therefore, water can sometimes find its way into the passengers compartment during or shortly after the car wash.

Convertible top

- f Never remove snow and ice using a sharp edged object.

Incorrect care and treatment can damage the convertible top and cause leaks. Any repair work can be done by your authorized Porsche dealer.

Important note

No folding top is 100% leak proof.

Due to the constant changing of loads and strains to which a car is subject to when driving on roads, minor wind noise and seepage at joints between the top, body and doors on convertible tops cannot be completely sealed in certain areas. Therefore small leaks are considered normal for these models. In addition, your convertible top should not be washed in a car wash. The top may experience damage by the brushes or may experience leaks due to the high pressure water streams directed in areas which would not encounter water in normal driving conditions.

Cleaning

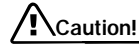

Risk of damage due to the cleaning jet of the high-pressure cleaning equipment or hot wax treatment.

- f Do not clean the convertible top with high-pressure cleaning equipment.
- f Do not use the hot wax treatment.

Do not wash the convertible top each time the car is washed.

It is usually sufficient to spray or wash it with clean water.

- f Brush dust off the convertible top in the direction of the weave using a soft brush.
- f Only if there is heavy dirt, wet the convertible top with lukewarm water and the Porsche Wash-Shampoo & convertible-top cleaner, using a sponge or soft brush, and rub gently. Rinse Wash-Shampoo & convertible-top cleaner thoroughly off the convertible top with clean water.
- f After washing it, treat the convertible-top cover at least once a year with the special Porsche convertible-top care product. Do not allow the convertible-top care product to come into contact with paint or windows. If it does, remove immediately.

- f If there is leakage in the convertible-top cover or at its seams or folds, the special Porsche convertible-top care product can be used.
- f Please note the information on the container.
- f Remove bird droppings immediately since the acid in them will make the rubber swell and the convertible top will become leaky.
- f Open convertible top only when it is completely dry, otherwise damp stains and scrub marks may occur which cannot be removed.
- f Try to remove spots from the convertible-top cover by rubbing carefully with a soft rubber sponge.

Door lock

- f To prevent the door lock from freezing during the cold season, the lock cylinder should be covered during a wash.
- f Should the lock freeze, use an ordinary de-icer. In many cases, a well warmed key can help. Never use excessive force.

Paint

To protect the paint on your vehicle in the best possible way against mechanical and chemical damage, you should

- preserve it regularly,
 - polish it if necessary,
 - remove spots and stains, and
 - repair damaged paintwork.
- f Do not apply care products containing silicone to the convertible top and windows.

General information

- f Never rub a dusty vehicle with a dry cloth, because the grains of dirt will damage the paintwork.
- f Do not treat matt-painted components with preservatives or polishes, otherwise the matt effect will be lost.

Preservation

The paint surface becomes dull over time due to weathering.

- f Preserve paint regularly.
- f Apply paint preservative after washing the vehicle and polish it smooth to preserve the paintwork.

This keeps the paint shiny and elastic. Dirt is prevented from adhering to the paint surface and industrial dust is prevented from penetrating the paint.

Polishing

Do not resort to using Porsche polish until it becomes evident that the normal preservatives no longer produce the desired finish.

Spots and stains

- f Remove tar stains, grease, oil spots and dead insects as soon as possible with Insect Remover. They can cause discoloration if allowed to remain on the paintwork.
- f Wash the affected area immediately after treating it.

Minor paint damage

- f Have minor paint damage, such as scratches, scores or chips caused by flying stones, repaired immediately by your authorized Porsche dealer before corrosion sets in.

However, if there are already traces of corrosion, they must first be removed carefully and thoroughly. Coat the area with a rust-proofing primer and finish off with a top coat. The paint code and color number are found on the data bank in the Maintenance booklet.

- f Please see the chapter "VEHICLE DATA BANK" on Page 284.

Engine compartment

The engine compartment and the surface of the engine are treated with a corrosion-inhibitor at the factory.

If degreasing solvents are used to clean the engine compartment or the engine is washed down, the process almost invariably removes the corrosion-inhibiting coating. It is then absolutely necessary to have a durable preservative applied to all surfaces, body seams, joints and assemblies in the engine compartment. This also applies when corrosion-inhibitor parts are replaced.



Risk of damage to the alternator.

- f Do not point the cleaning jet directly at the alternator, or cover the alternator.

Effective rust-proofing is particularly important during the cold weather season. If the vehicle is driven frequently in areas where salt has been spread on the roads, the engine compartment should be cleaned thoroughly and subsequently sealed after the cold weather season to prevent salt from causing any lasting damage.

Windows

The road dust which settles on the windshield and windows contains particles of tire rubber and oil residue. The interior trim and upholstery release particles, particularly in strong sunlight, which collect on the insides of the windows. These deposits are augmented by impurities in the air which enters the car through the fresh air vents.

- f Clean all windows regularly, inside and outside, with Porsche window cleaner.
- f If you use a chamois leather for the windows, do not use it for paintwork as it will otherwise pick up a certain amount of preservative or polish and could smear the windows and thus impair vision.
- f Remove dead insects with Porsche insect remover.

Note

Door windows feature a water-repellent (hydrophobic) coating which prevents soiling of the windows. This coating is subject to natural wear and can be renewed.

- f Consult an authorized Porsche dealer.

Wiper blades

Wiper blades that are in perfect condition are vital for a clear view.

- f Please see the chapter "WIPER BLADES" on Page 223.
- f Replace the wiper blades twice per year (before and after the cold season) or whenever wiper performance deteriorates or the blades are damaged.
- f Periodically clean the wiper blades with Porsche window cleaner, especially after the vehicle has been washed in a car wash. If they are very dirty (e.g. with insect remains), they can be cleaned with a sponge or cloth.

If the wiper blades rub or squeak, this can be as a result of the following:

- If the vehicle is washed in an automatic car wash, residues may adhere to the windshield. These wax residues can be removed only by using window cleaner concentrate.
 - The wiper blades may be damaged or worn.
 - Replace damaged or worn wiper blades immediately.
- f Please see the chapter "WASHER FLUID" on Page 220.
 - f Please contact your authorized Porsche dealer for further information.

Undercoating

As it is not possible to exclude the risk of damage to this protective coating in day to day driving, it is advisable to have the underside of the car inspected at certain intervals – preferably before the start of winter and again in spring – and the undercoating restored as necessary.

Your authorized Porsche dealer is familiar with the bodyseal treatment procedures and has the necessary equipment for applying factory approved materials. We recommend that you entrust them with such work and inspections.

Unlike conventional spray oils, undercoating and rust-proofing compounds based on bitumen or wax do not attack the sound-proofing materials applied at the factory.

Warning!

Danger of fire resulting in serious personal injury or death.

- f Do not apply additional undercoating or rust-proofing on or near the exhaust manifold, exhaust pipes, catalytic converters or heat shields. During driving the substance used for undercoating could overheat and ignite.
- f Before applying fresh underseal, carefully remove any deposits of dirt and grease. Once it has dried, the new undercoating compound forms a tough protective coating which provides efficient rust-proofing of the floor panels and components.

- f Always apply a fresh coating of suitable preservative to unprotected areas after cleaning the underside of the body, the transmission, the engine or carrying out repairs to underbody, engine or transmission components.

Effective rust-proofing is particularly important during the cold weather season. If your car is driven frequently in areas where salt has been spread on the roads, the whole engine compartment should be cleaned thoroughly after the winter to prevent salt from causing any lasting damage. A full under-body wash should also be performed at the same time.

Stainless steel exhaust tailpipes

Stainless steel exhaust tailpipes can discolor due to soiling, strong heat, and combustion residues.

The original polish can be achieved again using commercially available metal polishing paste or metal polish.

Light alloy wheels

- f Please see the chapter "WASHING" on Page 225.

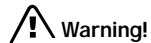

Warning!

Danger of accident resulting in serious personal injury or death if cleaning agents (e.g. wheel cleaning agents) come into contact with the brake discs.

The resulting film on the brake discs can impair braking performance.

- f Make sure that no cleaning agent comes into contact with the brake discs.
- f If cleaning agent has come into contact with the brake discs, thoroughly clean the brake discs with a strong jet of water.
- f Paying attention to any road users behind you, dry the brake discs by applying the brakes at short intervals.

Metal particles (such as brass or copper in brake dust) must not remain too long on alloy wheels. Contact corrosion can cause pitting.

Cleaners with an oxide-removing effect or the wrong pH value, as are commonly used for other metals, as well as mechanical tools and products, will damage the oxide layer and are therefore unsuitable.

- f **Use only cleaners for alloy wheels (pH value 9.5). Products with the wrong pH value can destroy the protective layer on the wheels.**
We recommend Porsche cleaner for alloy rims.
- f If possible, wash the wheels every two weeks with a sponge or washing brush. If the wheels are exposed to road salt, grit or industrial dust, weekly cleaning is necessary.

Door, roof, lid and window seals



Caution!

The lubricant coating on the inner door seals, convertible top and hardtop seals may be damaged by unsuitable cleaning and care agents.

- f Do not use any chemical cleaning agents or solvents.
- f Do not use any preservative agents.

- f Wash dirt (e.g. abrasion, dust, road salt and grit) from all seals regularly using warm soapy water.

- f If there is a risk of frost, protect the outer door seals and lid seals against freezing into place with a suitable care product.

Headlights, lights, interior and exterior plastic parts, adhesive films

Use **only** clean water and a little dishwashing detergent to clean light lenses, plastic headlight lenses, plastic parts and surfaces.

Do not clean when dry.

Use a soft sponge or a soft, lint-free cloth. Gently wipe the surface without applying too much pressure.

An interior window cleaner can also be used to clean plastic surfaces (always read the cleaning instructions on the container). We recommend Porsche interior window cleaner.

- f Gently wipe the surface without applying too much pressure.
- f Do not clean when dry.
- f Never use other chemical cleaners or solvents.
- f Rinse cleaned surfaces with clear water.

Leather

Characteristics and special features

The natural surface markings of leather, e.g. creases, healed scars, insect sting marks, structural differences and slight variations in shade and grain add to the attractiveness of the natural leather product.

Observe the following care instructions:

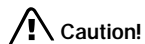

Caution!

The leather will be damaged by the use of unsuitable cleaning and care agents and by incorrect treatment.

- f Do not use caustic cleaners or hard cleaning aids.
 - f Perforated leather must under no circumstances get wet on its reverse side.
-
- f Clean all types of leather regularly to remove fine dust using a soft, damp, white woollen cloth or a commercially available microfibre cloth.

- f Remove heavy contamination with a leather cleaner.
Always read the instructions for use given on the containers.
We recommend Porsche leather cleaner.

Treat cleaned leather only with a leather care product.
We recommend the Porsche leather care product.

Cleaning airbags covers



Danger!

There is a danger of serious personal injury or death if the airbag system is impaired by improper cleaning work.

- f Do not make any modifications whatsoever on individual components such as the padded covers of the steering wheel, passenger side instrument panel, the front seats and the door linings.
- f Let your authorized Porsche dealer clean these components.

Carpets and floor-mats

- f Use only a vacuum cleaner or a medium stiff brush.
- f Remove stains and spots with Porsche stain remover.

To protect carpets, the Porsche range of accessories includes mats of the correct size and with the appropriate fastening.



Warning!

Risk of an accident resulting in serious personal injury or death.

- f Always check the movement of the pedals before driving and make sure that they are not obstructed by a floor-mat or any other object.
- f Secure the floor-mat to prevent it from sliding into positions that could interfere with the safe operation of your vehicle - do not install them loosely in the vehicle.
Your Porsche dealer will be glad to offer you nonskid floor-mats of the correct size.

Cleaning fabric linings

- f Fabric linings on pillars, convertible top liner and sun blinds, etc. must be cleaned only using suitable cleaning agents or a suitable dry foam and a soft brush.

Alcantara

- f Do not use a leather care product to clean Alcantara.

For regular care it is sufficient to clean the cover with a soft brush.

Heavy abrasion or rubbing when cleaning causes a lasting change in the surface.

Cleaning when lightly soiled

- f Wet a soft cloth with water or a neutral soap solution and wipe off the dirt.

Cleaning when heavily soiled

- f Wet a soft cloth with lukewarm water or thinned white spirit and dab the dirt from the outside in.

Cleaning Safety belts

- f Use mild detergent to clean soiled belts.
- f When drying, avoid direct sunlight.
- f Only use suitable cleaning agents.
- f Do not tint or bleach the belts.
The belt fabric could be weakened, thus affecting safety.

Storing your Porsche

If you intend to store your Porsche for a prolonged period, please consult your authorized Porsche dealer. The staff will be glad to advise you on the most suitable and necessary methods.

- f Clean your vehicle thoroughly inside and outside.
Clean the engine compartment.
The under carriage and chassis components should be free of dirt and salt deposits.
- f Fill up the fuel tank.
- f Change the oil and oil filter, and run the engine for several minutes.
- f Increase the tire pressure to 50 psi (3.5 bar). It is not recommended to lift the vehicle, due to the possibility of corrosion on shock absorber piston shafts.
The vehicle should be moved slightly, approximately every four weeks, to prevent flat spot on the tires.

Climate control

The air conditioning system should be in good working condition and fully charged.

Windshield/Headlight washer

- f Check and correct antifreeze/cleaning solution level as necessary.

Electrical system

- f Remove the battery from the vehicle and store it in a cool dry place, not on a cement floor.
When the battery is disconnected, the alarm system is deactivated.
- f Recharge the battery every 3 months. If the battery remains in the vehicle with the cables connected, it is necessary to check, remove and recharge the battery every 2-3 weeks.
Do not fast charge the battery.
- f Please see the chapter "BATTERY" on Page 261.

Vehicle interior

The interior must be dry, especially in the area of the floor carpets. The use of drying agents (Silica-Gel) is recommended in vehicles with leather interior and in areas with high humidity. The recommended amount is 3 fabric bags of 1.1 lbs. (500 grams) each placed on the floor carpets.

Windows, doors and lids must be closed. The air vents should be opened.

232 Maintenance, Car Care

Practical Tips, Emergency Service

Exercise Extreme Caution when Working on your Vehicle	234
Tires/Wheels	235
Loading Information.....	246
Wheel Bolts	248
Changing a wheel.....	249
Flat Tire.....	251
Lifting the Vehicle with a Lifting Platform or Garage Lift	254
Spacers 911 Carrera, 911 Carrera S	255
Electrical System	257
Battery	261
Replacing the remote-control battery	266
Emergency Starting with Jumper Cables	267
Bulb chart.....	269
Lights, Replacing Bulbs.....	269
Headlights	270
Number Plate Light.....	277
Changing Light-Emitting Diodes and Long-Life Bulbs	277
Adjusting Headlights	278
Towing	280

Exercise Extreme Caution when Working on your Vehicle



Danger!

Ignoring the following instructions may cause serious personal injury or death.

- f The engine compartment of any motor vehicle is a potentially hazardous area. If you are not fully familiar with proper repair procedures, do not attempt the adjustments described on the following pages.
This caution also applies to the entire vehicle.
- f Only work on your vehicle outdoors or in a well ventilated area.
- f Ensure that there are no open flames in the area of your vehicle at any time when fuel fumes might be present. Be especially cautious of such devices such as hot water heaters which ignite a flame intermittently.
- f Before working on any part in the engine compartment, turn the engine off and let it cool down sufficiently. Hot engine compartment components can burn skin on contact.
- f Be alert and cautious around engine at all times while the engine is running.
If work has to be performed with the engine running, always set the parking brake, and make sure the shift lever is in neutral position or the PDK selector lever in position **P** or **N**.
- f In particular, be very careful to ensure that items of clothing (ties, shirt, sleeves etc.), jewelry, long hair, hand or fingers cannot get caught in the engine-compartment blower, fan, belts or other moving parts.
The radiator and radiator fans are in the front of the car.
The engine-compartment blower is mounted on the engine-compartment lid.
The engine-compartment blower can start or continue running as a function of temperature, even with the engine switched off.
Carry out work in these areas only with the engine off, the ignition switched off, and exercise extreme caution.
- f Your Porsche is equipped with an electronic ignition system. When the ignition is on, high voltage is present in all wires connected with the ignition system; therefore, exercise extreme caution when working on any part of the engine while the ignition is on or the engine is running.
- f Always support your car with safety stands if it is necessary to work under the car.
Jacks are not suitable for this kind of work.
- f When working under the car without safety stands but with the wheels on the ground, make sure the car is on level ground, the wheels are blocked, and that the engine cannot be started.
Remove the ignition key.
- f Do not smoke or allow an open flame around the battery or fuel.
Keep a fire extinguisher in close reach.
- f Incomplete or improper servicing may cause problems in the operation of the car. If in doubt about any servicing, have it done by your authorized Porsche dealer.
Improper maintenance during the warranty period may affect your Porsche warranty coverage.
- f Supplies of fluids, e.g. engine oil, brake fluid or coolant, are hazardous to your health.
Keep these fluids out of children's reach and dispose of them in accordance with the appropriate regulations.
- f Some countries require additional tools and special spare parts to be carried.
Please make enquiries before driving abroad.

Tires/Wheels

The original equipment tires and wheel rims on your Porsche comply with all applicable Federal Motor Vehicle Safety Standards.

For your safety remember the following:

- Wheel rims and wheel bolts are matched to fit your Porsche.
- If you intend to use other than original equipment wheels, be sure that they conform to Porsche specifications for your model. Only tires with the same make and with the same specification code (e.g. "NO", "N1"...) can be mounted.
- The use of wheel rims and wheel bolts that do not meet specifications of the original factory installed equipment will affect the safe operation of your vehicle.
- Before you plan on exchanging wheels, or snow tires already mounted on the wheel rims, consult your authorized Porsche dealer. Your dealer has the technical information necessary to advise you which wheel rims and wheel bolts are compatible with the original factory installations.



Danger!

Risk of loss of control and serious personal injury or death.

- f If while driving, your vehicle experiences a sudden vibration or ride disturbance, and/or you suspect that possible damage to your tires or vehicle has occurred, you should immediately reduce your speed without excessive use of the brakes.
- f Stop the vehicle as soon as possible, and inspect the tires. If you cannot determine the cause for the disturbance, have your vehicle towed to the nearest Porsche or tire dealer to have your vehicle or tire(s) inspected.
- f Continuing to operate the vehicle without correction could result in a loss of control and serious personal injury.

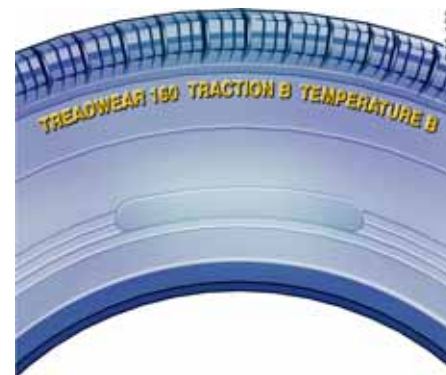

Example

Uniform Tire Quality Grading

Quality grades can be found where applicable on the tire sidewall between tread shoulder and maximum section width.

All passenger car tires must conform to Federal Safety Requirements in addition to these grades.

Treadwear

The treadwear grade is a comparative rating based on the wear rate of the tire when tested under controlled conditions on a specific government test course.

For example, a tire graded 150 would wear one

Practical Tips, Emergency Service **235**

and a half (1-1/2) times as well on the government course as a tire graded 100.

The relative performance of tires depends upon the actual conditions of their use, however, and may depart significantly from the norm due to variations in driving habits, service practices and differences in road characteristics and climate.

Traction AA, A, B, C

The traction grades, from highest to lowest, are AA, A, B, and C and they represent the tire's ability to stop on wet pavement as measured under controlled conditions on specified government test surfaces of asphalt and concrete.

A tire marked C may have poor traction performance.

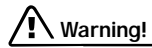

The traction grade assigned to this is based on braking (straight-ahead) traction tests and does not include cornering (turned) traction, acceleration, hydroplaning or peak traction characteristics.

Temperature A, B, C

The temperature grades are A (the highest), B and C, representing the tire's resistance to the generation of heat and its ability to dissipate heat when tested under controlled conditions on a specified indoor laboratory test wheel.

Sustained high temperatures can cause the material of the tire to degenerate and reduce tire life, and excessive temperature can lead to sudden

tire failure.

The grade C corresponds to a level of performance which all passenger car tires must meet under the Federal Motor Vehicle Safety Standard No. 109.

Grades B and A represent higher levels of performance on the laboratory test wheel than the minimum required by law.



The temperature grade for this tire is established for a tire that is properly inflated and not overloaded.

Excessive speed, underinflation, or excessive loading, either separately or in combination, can cause heat buildup and possible tire failure, resulting in serious personal injury or death.

Tire pressures



Incorrect tire pressure causes increased tire wear and adversely affects road handling. This could lead to tire failure, resulting in loss of control, leading to serious personal injury or death.

- f Always use an accurate tire pressure gage when checking inflation pressures.
- f Do not exceed the maximum tire pressure listed on the tire sidewall. Please see the chapter "TIRE PRESSURE PLATE" on Page 285.

- f Cold tire inflation pressure means: all tires must be cold, ambient temperature maximum (68 °F/20 °C), when adjusting the inflation pressure. Avoid sunlight striking the tires before measuring cold pressures, since the pressures would rise from temperature influence.
 - f Valve caps protect the valve from dust and dirt, and thus from leakage. Always screw caps tightly down. Replace missing caps immediately.
 - f Use only plastic valve caps.
 - f Do not use commercially available sealant or tire inflating bottles. Only use Porsche approved tire sealant.
-
- f Please see the chapter "TIRE PRESSURES FOR COLD TIRES (68 °F / 20 °C)" on Page 289.

Each tire, should be checked every 2 weeks when cold (68 °F/20 °C) and inflated to the inflation pressure recommended in this Owner's Manual or on the tire-pressure plate.

If your vehicle has tires of a different size than the size indicated in this Owner's Manual or on the tire-pressure plate, you should determine the proper tire inflation pressure for those tires.

As an added safety feature, your vehicle has been equipped with a tire pressure monitoring (TPM) that illuminates a low tire pressure message when one or more of your tires is significantly under-inflated. Accordingly, when the low tire pressure message illuminates, you should stop and check your tires as soon as possible, and inflate them to the proper pressure. Driving on a significantly under-inflated tire causes the tire to overheat and can lead to tire failure. Under-inflation also reduces fuel efficiency and tire tread life, and may affect the vehicle's handling and stopping ability.

Please note that the TPM is not a substitute for proper tire maintenance, and it is the driver's responsibility to maintain correct tire pressure, even if under-inflation has not reached the level to trigger illumination of the TPM low tire pressure message.

- f On vehicles with tire pressure monitoring: Please see the chapter "TPM TIRE PRESSURE MONITORING" on Page 143.

When tires are warm, the tire pressure is increased.

- f Never let air out of hot tires. This could cause the tire pressure to fall below the prescribed value.

Insufficient tire filling pressure can cause tires to overheat and thus be damaged – even invisibly. Hidden tire damage is not eliminated by subsequently correcting the tire pressure.

Overloading



Risk of damage to vehicle parts, loss of control and serious personal injury or death.

- f Do not overload your vehicle. Be careful about the roof load.
- f If loading the vehicle also correct the tire pressure. Tire pressure for loaded vehicle can be found on the tire pressure plate and in the chapter technical data.
- f Never exceed the specified axle load. Overloading can shorten the service life of the tires and car, as well as lead to dangerous vehicle reactions and long braking distances. Damage due to overloading is not covered by the vehicle warranty.
- f Please see the chapter "LOADING INFORMATION" on Page 246.
- f Please see the chapter "TIRE PRESSURES FOR COLD TIRES (68 °F / 20 °C)" on Page 289.

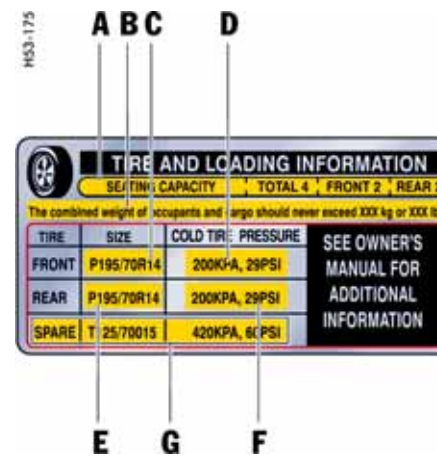

Example of a tire pressure plate

Tire pressure plate

Information on the tire pressure plate

- A Seating capacity
Maximum number of vehicle occupants, including the driver.

- B Vehicle load limit
Is the maximum total weight limit specified of the load (passengers and cargo) for the vehicle. This is the maximum weight of passengers and cargo that can be loaded into the vehicle. Please see the chapter "LOADING INFORMATION" on Page 246.
- C Tire size for the front axle
Check with your authorized Porsche dealer about the current release status.
- D Recommended tire pressure for the front axle
These values are for cold tires (68 °F/20 °C).
- E Tire size for the rear axle
Check with your authorized Porsche dealer about the current release status.
- F Recommended tire pressure for the rear axle.
These values are for cold tires (68 °F/20 °C).
- G In vehicles with collapsible spare wheel:
Size and tire pressure of the spare wheel.

Tire traction

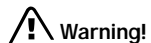

Warning!

When driving on wet or slushy roads, a wedge of water may build up between the tires and the road. This phenomenon is known as "hydroplane" and may cause partial or complete loss of traction, vehicle control or stopping ability.

- f Reduce speed on wet surface to prevent this.

Tire life

Tire life depends on various factors, i. e., road surfaces, traffic and weather conditions, driving habits, type of tires and tire care.

- f Inspect your tires for wear and damage before driving off. If you notice uneven or substantial wear, wheels might need alignment or tires should be balanced or replaced.

Tire wear

The original equipment tires on your Porsche have built-in tire wear indicators. They are molded into the bottom of the tread grooves and will appear as approximately 1/2 in. (12 mm) bands when the tire tread depth is down to 1/16 of an in. (1.6 mm).

When the indicators appear in two or more adjacent grooves, it is time to replace the tires. We recommend, however, that you do not let the tires wear down to this extent.

Worn tires cannot grip the road surface properly and are even less effective on wet roads.

Snow tires lose their traction capability when their tread depth falls below 5/32 in. (4 mm).

In the United States, state laws may govern the minimum tread depth permissible. Follow all such laws.



Danger!

Driving on worn tires can result in loss of control of the vehicle and could cause serious personal injuries or death.

- f Do not drive with worn tires or tires showing cuts or bruises as they may lead to sudden deflation and loss of control which could cause severe personal injury.
- f Specialized high performance tires on high performance sports cars exhibit more wear than those on a family sedan, or even a high performance sedan.
Therefore, it is important to check your tire pressure and condition at least every two weeks.

If you notice that tires are wearing unevenly, consult your Porsche dealer.
Uneven wear may not always be due to improper wheel alignment. It can be the result of individual driving habits such as cornering at high speeds. If the tire pressure is not checked and adjusted regularly, abnormal tire wear can also occur.

Tire care

- f Avoid damaging tires and wheel rims.
- f If you must drive over a curb or other obstacle, drive slowly and at an obtuse angle.
- f Check tires for uneven wear and damage before driving off.
- f Remove imbedded material.
- f Replace worn or damaged tires immediately.
- f Keep oil, fuel, brake fluid, etc. away from tires.
- f Replace missing valve stem caps.
- f Keep tires inflated correctly.
- f Wash tires when washing the vehicle. Also clean inner side of wheels.
- f Do not use abrasive cleaners when washing the wheels.
- f Check wheel rims for corrosion.
- f Remove road salt, if driving in winter.

Tire damage, puncture

High-pressure cleaning units can damage the tires.

- f Please see the chapter "HIGH-PRESSURE CLEANING UNITS, STEAM CLEANERS" on Page 224.
- f Check tires for imbedded material, cuts, punctures, cracks and bulges (side wall) before driving off.

In case of tire damage, where it is uncertain whether there is a break in the ply with all its consequences or tire damage caused by thermal or mechanical overloading due to loss of pressure or any other prior damage, we recommend that the tire be replaced for safety reasons.

If one faulty tire is replaced it should be noted that the difference in tread depth on one axle must not exceed 30%.

Handling inconsistencies may result.

- f Perform a visual inspection if necessary.



Danger!

Risk of serious personal injury or death. Driving the vehicle with low tire pressure increases risk of a tire failure and resulting loss of control. Furthermore, low tire pressure increases rate of wear of the affected tires.

- f Check tires – including sidewalls – regularly for foreign bodies, nicks, cuts, cracks and bulges.
- f After driving off road, examine tires for signs of damage such as cuts, tears, bulges or foreign objects stuck in the tread. Replace a damaged tire if necessary.
- f Cross curb edges slowly and at right angles if possible. Avoid driving over steep or sharp curbs.
- f In cases of doubt, have the wheel (particularly the inner side) checked by an authorized Porsche dealer.

Tire replacements

If in doubt, contact your Porsche dealer. Use only tire makes and types approved by Porsche.

If you do not use a Porsche recommended replacement tire, make sure that you purchase your new tires from a reputable tire dealer and that the dealer complies with all manufacturers warnings for those tires.

Only tires with the same make and with the same specification code (e.g. "NO", "N1"...) can be mounted.

Before mounting new tires, check with your Porsche dealer about the current release status.

Use tires with "ZR" quality standards. There are currently no standards concerning tire strength at speeds above 150 mph (240 km/h).

Tires should be replaced no less than on one axle at the time.

Only tires of the same make and type must be used. Mixed tires are not permissible.

Initially, new tires do not have their full traction. You should therefore drive at moderate speeds during the first 60 - 120 miles (100 - 200 km).

If new tires are installed only on one axle, a noticeable change in handling occurs due to the different tread depth of the other tires.

This happens especially if only rear tires are replaced. However, this condition disappears as the new tires are broken in.

- f Please adjust your driving style accordingly.

Installation of new tires should only be done by a qualified tire technician.

Valves

Rubber valve stems must be replaced every time a tire is replaced.

For metal valves, the installation and replacement instructions must be observed.

- f Use only genuine Porsche metal valves.
- f Protect the valve inserts against soiling with valve caps. Soiled valve inserts can cause a gradual loss of air.
- f Use only plastic valve caps.

Parking at the curb



Warning!

Hard impacts against curbs (or traffic islands) are dangerous and may cause hidden tire damage which is not noticeable until later. Such damage can result in accidents at high speeds causing serious personal injury or death.

Depending on the force of impact, the edge of the rim can also be damaged.

- f If you are in doubt, have the wheel checked by an expert, particularly if you suspect damage on the inside.
- f If you must drive over a curb or other obstacle, drive slowly and at an obtuse angle. Exercise care when parking along curbs.

Wheel alignment, wheel balancing

As a precaution, have wheels with summer tires balanced in the spring, and those with mud and snow tires before winter.

Unbalanced wheels may affect car handling and tire life.

Only the specified weights may be used for wheel balancing.

Self-adhesive weights must not come into contact with cleaning agents, since they could drop off. Uneven tread wear indicates wheel imbalance. In this event, the vehicle should be checked at an authorized Porsche dealer.



Warning!

If, during a trip, uneven running or vibrations occur that could be caused by damage to tires or the car, the speed must be reduced immediately, but without braking sharply. If you continue your trip without having the cause of the fault remedied, you might lose control of your vehicle which could cause serious personal injury or death.

- f Stop the vehicle and check the tires.
- f If no cause for the fault can be found, drive carefully to the nearest authorized Porsche dealer.

Wheels with Tire Pressure Monitoring (TPM) sensors

Before changing wheels, make sure that the wheels are compatible with your vehicle's TPM.

- f Check this with your authorized Porsche dealer.

Removing and storing tires

- f After changing, adjust tire pressure and torque wheel bolts diagonally to 94 ftlb (130 Nm).

Tires must always remain on the same side of the vehicle.

When wheels are removed, the direction of rotation and position of each wheel should be marked.

Example

FR (front right), FL, RR and RL.

Wheels must always be fitted in accordance with their marking.

The perception that tire durability and performance are immune to the effects of storage and age is unfounded.

Chemical additives, which make the rubber elastic, lose their effectiveness in the course of time and the rubber becomes brittle and cracks.

Therefore, the tires should be inspected from time to time.

Note

Under no circumstances should tires older than 6 years be used on your Porsche.

The age of the tire can be obtained from the "DOT" code number. If, for example, the last four numbers read 1208, then the tire was produced in the 12th week of 2008.

f Store tires in a cool and dry place.

Snow tires

For a better grip on snow and ice, use radial M+S tires with studs.

Check with your local Motor Vehicle Bureau for possible restrictions.



Risk of loss of control and damage to the vehicle as well as serious personal injury or death.

The standard tires profile and rubber mixture are optimized for wet and dry driving conditions, and may not prove favorable for snow conditions.

f Therefore install M+S tires before driving in such conditions.

Before mounting snow tires, consult with your Porsche dealer. He has the technical information necessary to advise you on wheel and tire compatibility.

Snow tires should have the same load capacity as original equipment tires and should be mounted on all four wheels.

Snow tires with studs should be run at moderate speeds when new in order to give the studs time to settle.



Tires with badly worn treads and studs are very dangerous and could cause accidents resulting in serious personal injuries or death.

f Make sure they are replaced immediately.

f Do not drive a vehicle equipped with snow tires at prolonged high speed.

Snow tires do not have the same degree of traction on dry, wet or snowfree roads as a normal tire.

Furthermore, snow tires wear rapidly under these conditions.

Comply with all state and local laws governing snow tire and tread depth requirements.



Risk of accident and serious personal injury or death due to excessive speed.

f Always check the maximum speed rating on the tire sidewall on any tire on the vehicle.

f Never exceed the maximum speed rating of the tires.

f Fit winter tires to both axles well before the cold season begins.
Your authorized Porsche dealer will be pleased to advise you.

Maintenance note

We recommend fitting snow tires on the vehicle at temperatures below 45 °F (7 °C) since the driving performance of summer tires is reduced at low temperatures. Summer tires may be permanently damaged at extremely low temperatures.

Winter tires lose their traction capability when their tread depth falls below 5/32 in. (4 mm).

Snow chains



Caution!

Risk of damage to body, axle or brake components.

- f Fit snow chains only to the rear wheels, and only with the tire/rim combination listed in the Technical Data.
To ensure adequate clearance between chain and body, Porsche recommends only the use of fine-link chains such as those approved by Porsche.
- f Follow instructions issued by the supplier of the chains.

Different states and countries have varying statutory requirements regarding maximum speed. Check with local authorities for possible restrictions.

- f Remove chains as soon as the roads are free of ice and snow.

911 Carrera, 911 Carrera S

Fitting snow chains

The use of snow chains is not permitted when 5 mm spacers are mounted.



Caution!

Risk of damage to the wheel housings if the 5 mm spacers are not removed before fitting snow chains.

- f To permit the fitting of snow chains, have the 5 mm spacers removed on all 4 wheels.
- f To fit/remove the spacers:
Please consult an authorized Porsche dealer.
- f Please see the chapter "SPACERS 911 CARRERA, 911 CARRERA S" on Page 255.

Tire designations

Due to new speed and load ratings for radial tires, new designations have come into force for snow tires for your Porsche.

The designation to be used for ZR tires is e.g., 265/40 ZR 18 (Z = code letter for radial tires for speeds above 150 mph / 240 km/h).



Example of Inscription

Inscription on radial tire

A Tire size

Example: P 295/30 ZR 19 100 Y

- **P** - The tire is designed for Passenger vehicle. This information is not included on all tires.
- **295** - Indication of tire width in mm
- **30** - Indication of tire height to tire width ratio in percent

- **ZR** - code letter for radial tires for speeds above 150 mph / 240 km/h
There are currently no standards concerning tire strength at speeds above 150 mph (240 km/h).
- **R** - Belt type code letter for radial
- **19** - Indication of rim diameter in inches
- **100** - Load capacity coefficient
- **Y** - Speed code letter
- **XL (Extra Load)** - Tire with increased load rating

B TIN (Tire Identification Number)

Example: DOT xx xx xxxx xxxx

- **DOT**
The DOT symbol indicates that the tires comply with the requirements of the US Department of Transportation and provides information about:
 - first two-digit code means manufacturer's identification mark.
 - second two-digit code means tire size.
 - third four-digit code means tire type code.
 - fourth four-digit code means date of manufacture.
If, for example, the last four numbers read 0204, the tire was produced in the 2nd week of 2004.

C Tire ply composition and material

The number of layers in the tread and sidewalls and their material composition.

D Maximum permissible inflation pressure

The maximum permissible cold inflation pressure to which a tire can be inflated.

- f Do not exceed the permissible inflation pressure.

E Maximum Load rating

The maximum load in kilograms and pounds can be carried by the tire. If you replace tires always use a tire that has the same maximum load rating as the factory installed tire.

F Radial

The identification indicates if the tire has radial structure.

G Term of tubeless or tube tire

Identification for tubeless tires.

Speed code letter

The speed code letter indicates the maximum permissible speed for the tire.

This code letter is shown on the tire sidewall.

T	=	up to 118 mph (190 km/h)
H	=	up to 131 mph (210 km/h)
V	=	up to 150 mph (240 km/h)
W	=	up to 167 mph (270 km/h)
Y	=	up to 186 mph (300 km/h)
(Y)	=	up to 186 mph (300 km/h) as for Y tires. Speeds of more than 300 km/h (186 mph) are also possible at a maximum tire load capacity of 85 % (confirmation from tire manufacturer required for speeds of more than 186 mph (300 km/h)).

Tip on driving

Tires with a maximum speed rating that is lower than the specified maximum vehicle speed may be mounted only if they bear an M+S identification on the tire sidewall.

- f Please note that in addition to the winter tires, all-season and all-terrain tires are also subject to speed limits and bear this identification.

Inscription on light alloy wheels

Maintenance note

- f Protect the valve inserts against soiling with valve caps.
Use only plastic valve caps.
Soiled valve inserts can cause a gradual loss of air.

Note on operation

- f The rim width in inches **A** and the rim offset **F** are visible from the outside.
The information is inscribed on the back of the spokes near the tire valve.



- A - Rim width in inches
- B - Rim-flange contour code letter
- C - Symbol for drop-center rim
- D - Rim diameter in inches
- E - Double hump
- F - Rim offset in mm

Loading Information

Definitions

The Curb weight - actual weight of your vehicle - vehicle weight including standard and optional equipment, fluids and emergency tools. This weight does not include passengers and cargo.

The Gross Vehicle Weight is sum of the curb weight and the weight of passengers and cargo combined.

The Gross Vehicle Weight Rating is the maximum total weight of vehicle, passengers, luggage and optional equipment.

The Gross Axle Weight Rating is the maximum load limit for the front or the rear axle. This information is located on the safety compliance sticker located in the driver's side door jamb.

For determining the compatibility of the tire and vehicle load capabilities:

f Please see the chapter "TECHNICAL DATA" on Page 286.

The load capacity coefficient (e.g. "100") is a minimum requirement.

The Gross Combined Weight Rating is the maximum total weight rating of vehicle, passengers and cargo.

The Vehicle Capacity Weight - Load Limit - is the maximum total weight limit specified of the load (passengers and cargo) for the vehicle. This is the maximum weight of passengers and cargo that can be loaded into the vehicle. This information can be found on the tire pressure plate.

The maximum loaded vehicle weight is the sum of curb weight, accessory weight, vehicle capacity weight and production options weight.

The load rating is the maximum load that a tire is rated to carry for a given inflation pressure.

The maximum load rating is the load rating for a tire at the maximum permissible inflation pressure.

The cargo capacity is the permissible weight of cargo, the subtracted weight of passengers from the load limit.

f Never exceed the permissible limits.

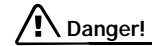

Risk of loss of control, damage to the vehicle and serious personal injury or death.

- f Never exceed the specified axle loads. Overloading can shorten the service life of the tires and car, as well as lead to dangerous vehicle reactions and long braking distances. Damage due to overloading is not covered by the vehicle warranty.
-

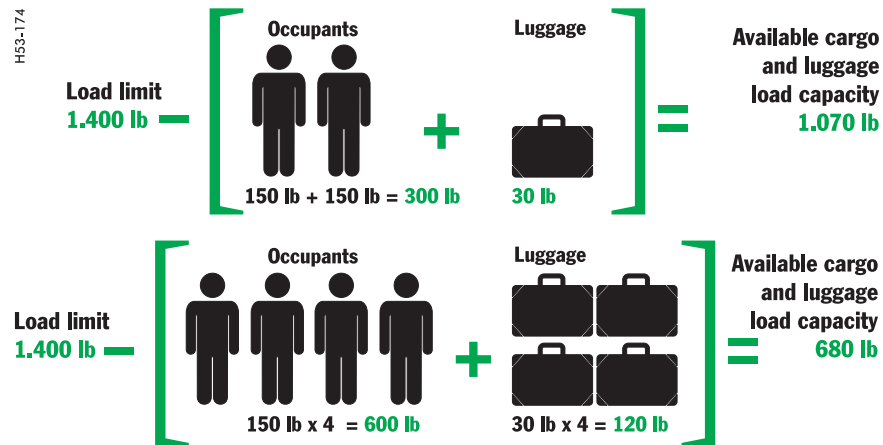

Example for determining the combined weight of occupants and cargo

Vehicle Load Capacity

- f The combined weight of occupants and cargo should never exceed the weight shown on the tire plate in the vehicle. Please see the chapter "TIRE PRESSURE PLATE" on Page 285.
- f Never exceed the number of passengers shown on the tire pressure plate in the vehicle.

Determining the combined weight of occupants and cargo:

- f Add the weight of all occupants and then add the total luggage weight (figure).

Steps for determining correct load limit

1. Locate the statement "The combined weight of occupants and cargo should never exceed XXX pounds" on your vehicle's placard (depending on the date of manufacture).
2. Determine the combined weight of the driver and passengers that will be riding in your vehicle.

3. Subtract the combined weight of the driver and passengers from XXX kilograms or XXX pounds.
4. The resulting figure equals the available amount of cargo and luggage load capacity. For example, if the "XXX" amount equals 1400 lbs. and there will be five - 150 lb passengers in your vehicle, the amount of available cargo and luggage load capacity is 650 lbs. (1400 - 750 (5 x 150) = 650 lbs.)
5. Determine the combined weight of luggage and cargo being loaded on the vehicle. That weight may not safely exceed the available cargo and luggage load capacity calculated in Step 4.

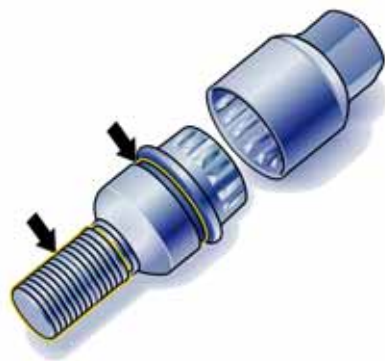

- f Always clean the wheel bolts before fitting.
- f Apply a thin coat of **Optimoly TA** (aluminum paste) on the thread and between the bolt head and movable spherical cap ring (**arrows**).
The bearing surface of the spherical cap facing the wheel must not be greased.
- f Replace damaged wheel bolts.
Only use the Original Porsche wheel bolts specially designed for this vehicle type.

Tightening torque

Tightening torque of wheel bolts:
96 ftlb./130 Nm

Wheel Securing Bolts

If the wheels have to be removed at the workshop, please do not forget to hand over the wrench socket for the wheel securing bolts along with the car key.

The wrench socket for the wheel securing bolts is in the tool box.

To loosen or tighten the wheel bolt with anti-theft protection, a wrench socket with the appropriate coding must be used between the wheel bolt and the wheel-bolt spanner.

- f When positioning the wrench socket, ensure that it engages fully in the teeth of the wheel bolt.

Wheel Bolts



Danger!

Risk of wheel bolt breakage and wheel separation, resulting in serious personal injury or death.

- f Follow all instructions concerning wheel bolts.

Changing a wheel



Warning!

Risk of serious personal injury or death. The car may slip off the jack.

- f Make sure that no one is in the vehicle when jacking up and changing a wheel.
- f Always place the car on stable supports if work has to be carried out under the car.

Risk of damage to the brake discs of the Porsche Ceramic Composite Brake (PCCB).

- f Always screw in both assembly aids when changing a wheel.

Note

The tools required for changing a wheel (e.g. jack, wheel bolt wrench, assembly aids) are not supplied with the car. Your authorized Porsche dealer will be pleased to advise you.

1. Apply the handbrake fully and engage 1st gear or PDK selector-lever position **P** and remove the ignition key.
2. Switch on the hazard warning lights if necessary.
3. Secure the car against rolling away, e.g. by means of wedges under the wheels on the opposite side. This is particularly important on slopes.
4. Slightly slacken the wheel bolts of the wheel to be changed.
5. Lift the car only at the specified jacking points.
6. Raise the car until the wheel lifts off the ground. Please see the chapter "LIFTING THE VEHICLE WITH A LIFTING PLATFORM OR GARAGE LIFT" on Page 254.
7. Remove 1 or 2 wheel bolts (see respective illustration).
8. Screw in assembly aids instead of the wheel bolts.



881-164

*Screw in assembly aid for vehicles **without** Porsche Ceramic Composite Brake*

9. Remove the remaining wheel bolts.

Note on operation

- f To remove or mount the spacers: Please see the chapter "SPACERS 911 CARRERA, 911 CARRERA S" on Page 255.



Screw in two assembly aids for vehicles **with** Porsche Ceramic Composite Brake

10. Take the wheel off and put a new wheel on.

Please see the chapter "WHEEL BOLTS" on Page 248.

11. Insert wheel bolts and tighten by hand.

12. Remove assembly aids, screw in remaining wheel bolts.

Initially tighten bolts only slightly in diagonally opposite sequence so that the wheel is centred.

13. Inflate the tire if necessary.

Please see the chapter "TIRE PRESSURES FOR COLD TIRES (68 °F / 20 °C)" on Page 289.

14. Lower the car fully and remove the jack.

15. Tighten wheel bolts in diagonally opposite sequence.

f Immediately after changing a wheel, use a torque wrench to check the prescribed tightening torque (96 ftlb./130 Nm).

Note on operation for vehicles with Tire Pressure Monitoring

f On vehicles with Tire Pressure Monitoring, the settings on the on-board computer must be updated after the wheel change.

f Please see the chapter "TPM TIRE PRESSURE MONITORING" on Page 143.

Checking tire pressure with a pressure gage

1. Remove the valve stem cap from the tire.
2. Press the pressure gage onto the valve stem.

Note on operation

- f** Do not press too hard or force the valve stem sideways, or air will escape. If the sound of air escaping from the tire is heard, reposition the pressure gage.
3. Read the tire pressure on the gage stem and compare it to the permissible tire pressure. This information can be found on the tire pressure plate or in the chapter Technical Data. Please see the chapter "TIRE PRESSURES FOR COLD TIRES (68 °F / 20 °C)" on Page 289.
 4. Remove the pressure gage.
- f** Please see the chapter "TPM TIRE PRESSURE MONITORING" on Page 143.

Flat Tire



Failure to follow these instructions may result in serious personal injury to you or to bystanders.

- f If you have a flat tire, move a safe distance off the road. Turn the emergency flasher on and use other warning devices to alert other motorists. Set the parking brake.
- f Do not park your vehicle where it may contact dry grass, brush or other flammable materials. The hot parts of the exhaust system could set such materials on fire, thereby causing both property damage and serious personal injury or death.

A tire sealant and compressor with pressure tester are located in the luggage compartment.

- f Please observe the safety and operating instructions on the special sealant bottle with a special Porsche part number and on the compressor – these are essential.

Important note

Sealing the tire with the tire repair kit is only an emergency repair. Even with the tire airtight, it may be used only for short journeys in an emergency.

The maximum permitted speed is 50 mph (80 km/h).

- f Do not use commercially available sealant or tire inflating bottles.
Use only the tire sealant located in the luggage compartment.



Risk of accident, resulting in serious personal injury or death.

- f Have tires replaced by a specialist workshop as soon as possible.
 - f Avoid hard acceleration and high cornering speeds.
-



A - Filler bottle
B - Filler hose

Tire sealant

The tire sealant can be used to seal small cuts, especially in the tire tread.

Sealing the tire with the tire sealant is only an emergency repair, so you can drive to the next workshop. Even with the tire air-tight, it may be used only for short journeys in an emergency.

RS1-160

The tire sealant and a compressor with pressure tester can be found in the luggage compartment.

The tire sealant comprises:

- A filler bottle
- A sticker denoting the maximum permissible speed for the driver's field of vision
- A filler hose
- A valve turner and
- A spare valve insert.

! Danger!

Risk of accident, resulting in serious personal injury or death.

- f Use the tire sealant only in the case of cuts or punctures no larger than 0.15 in. (4 mm).
- f Never use the tire sealant if the rim is damaged.

! Warning!

The sealant is highly flammable and harmful to health.

- f Fire, naked flame and smoking are prohibited when handling tire sealant.
- f Avoid contact with skin, eyes or clothing due to caustic chemical properties of the tire sealant.
- f Keep tire sealant away from children.
- f Do not inhale vapors, due to consequent harm to personal health resulting in serious personal injury or death.

In case of contact with the sealant:

- f If sealant gets on the skin or in the eyes, thoroughly rinse the affected part of the body off immediately.
- f Change soiled clothing immediately.
- f Get medical attention immediately in the event of an allergic reaction.
- f If sealant was swallowed, thoroughly rinse out the mouth without delay and drink plenty of water.
Do not induce vomiting.
Get medical attention immediately.

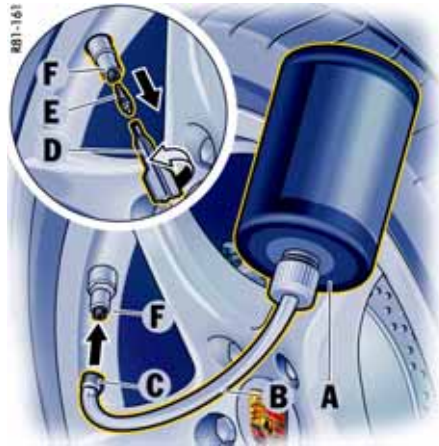

- A - Filler bottle
- B - Filler hose
- C - Plug of the filler hose
- D - Valve turner
- E - Valve insert
- F - Tire valve

Inserting sealant

1. Leave the object that caused the puncture in the tire.
2. Remove sealant and the enclosed sticker from the luggage compartment.
3. Adhere the sticker in the driver's field of vision.
4. Shake filler bottle **A**.

5. Screw filler hose **B** onto the filler bottle. The filler bottle is now open.
6. Unscrew valve cap from tire valve **F**.
7. Remove valve insert **E** from the tire valve with valve turner **D**. Keep the valve insert in a clean and dry place.
8. Remove plug **C** of the filler hose **B**.
9. Push filler hose onto the tire valve.
10. Hold filler bottle higher than the level of the tire valve and press it together forcefully until the bottle is completely emptied into the tire.
11. Pull filler hose off the tire valve.
12. Twist the valve insert firmly into the tire valve using the valve turner.
13. Connect the compressor to the cigarette lighter and inflate the tire to the prescribed tire pressure. Please see the chapter "TIRE PRESSURES FOR COLD TIRES (68 °F / 20 °C)" on Page 289.
14. Screw valve cap onto the tire valve.
15. Check the tire pressure after driving for around 10 minutes. If the tire pressure is less than 22 psi (1.5 bar), do not continue driving. If a value of more than 22 psi (1.5 bar) is indicated, correct the pressure to the prescribed value.

16. Please consult your authorized Porsche dealer.

Note on operation for vehicles with Tire Pressure Monitoring

- f On vehicles with Tire Pressure Monitoring, the settings on the on-board computer must be updated after the wheel change. Please see the chapter "TPM TIRE PRESSURE MONITORING" on Page 147.

Care Instructions

After drying, any sealant that emerges can be peeled off like a film.

Warning!

Risk of accident, resulting in serious personal injury or death.

- f Have the tire replaced by an authorized Porsche dealer immediately.
- f Avoid hard acceleration and high cornering speeds.
- f Do not exceed maximum speed of 50 mph (80 km/h).
- f Please always observe the safety and operating instructions, which can be found in the separate operating instructions for the sealant and on the compressor.

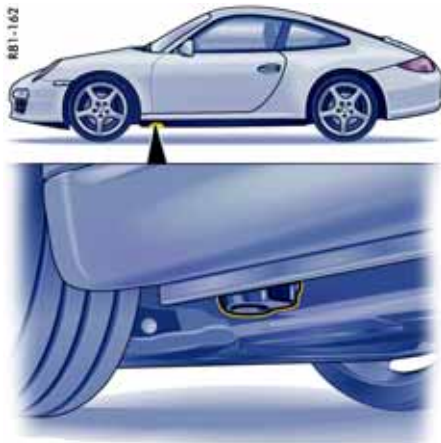

Lifting the Vehicle with a Lifting Platform or Garage Lift

The car must be raised **only** at the illustrated jacking points.

Caution!

Serious personal injury or death and/or serious damage to the engine or the vehicle may occur, if you lift the vehicle improperly.

- f Never lift the vehicle at any other place than the jacking points.
- f Never lift the vehicle by the engine, transmission or axles.
- f Do not damage any sensitive components in the vicinity of the jacking points.

Platform lift

Before the car is driven on to a lifting platform, it must be ensured that there is enough space between the lifting platform and the vehicle.

Garage lift

A garage lift must be used **only** at the illustrated jacking points.

Spacers

911 Carrera, 911 Carrera S

- f Use the spacers only together with wheels and fastening parts approved by Porsche.
Before having spacers fitted, find out about the current approval status.

Mounting an emergency spare wheel

If 5 mm spacers are mounted, these must **not** be removed to mount an emergency spare wheel.

Fitting snow chains

The use of snow chains is not permitted when 5 mm spacers are mounted.

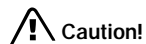

Caution!

Risk of damage to the wheel housings if the 5 mm spacers are not removed before fitting snow chains.

- f To permit the fitting of snow chains, have the 5 mm spacers removed on all 4 wheels.

Note on operation

- f To fit/remove the spacers:
Please consult an authorized Porsche dealer.
- f Please see the chapter "CHANGING A WHEEL" on Page 249.

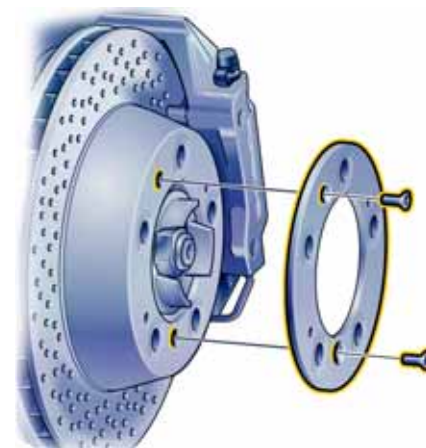

Removing the spacers

1. Unscrew both countersunk screws (M6x16) on the wheel hub.
2. Remove the spacer.
3. Fasten the brake disc with the **short** M6x12 countersunk screws, part No.: 900.269.047.09.
Tightening torque **7.5 ftlb. (10 Nm)**.
4. For wheel mounting without a spacer, 5 mm **shorter** wheel bolts (part No.: 997.361.203.01) must be used.
Tightening torque: **96 ftlb. (130 Nm)**.

Mounting the spacers

Practical Tips, Emergency Service **255**

1. Remove wheel.
 2. Unscrew both countersunk screws (M6x12) on the break disc.
 3. Fasten the spacer with the **long** M6x16 countersunk screws.
Tightening torque **7.5 ftlb. (10 Nm)**.
 4. Fit wheel. To do this use the **longer** wheel bolts for fastening the wheels.
Tightening torque: **96 ftlb. (130 Nm)**.
- f Please see the chapter "CHANGING A WHEEL" on Page 249.

Required scope of parts if the spacers are removed

Short countersunk screws (M6x12)
Part No: 900.269.047.09

1 set short wheel bolts
Part No: 997.361.203.01

Short anti-theft protection
Part No: 996.361.057.01

- f For information on the spacers: Please see the chapter "SPACERS 911 CARRERA, 911 CARRERA S" on Page 255.

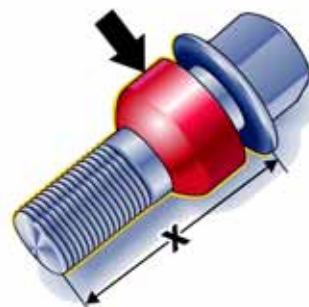

*Long wheel bolt
X = bolt length approx. 49 mm
Arrows = spherical cap ring*

Wheel bolt identifying features

For identification purposes, the movable spherical cap ring is galvanised in red on the **long** wheel bolts.

The long wheel bolts must only be used together **with** 5 mm spacers fitted.

The **short** wheel bolts are not marked in colour.
The short wheel bolts must only be used **without** 5 mm spacers fitted.

- f Tightening torque for both wheel bolts:
96 ftlb. (130 Nm).

Electrical System

In order to avoid damage and faults in electrical or electronic systems, electrical accessories should be installed at your authorized Porsche dealer.

- f Only use accessories authorized by Porsche.

Warning!

Risk of short circuit and fire, resulting in serious personal injury or death.
Replacing fuses or relays with the engine running or the ignition on could cause electrical shock.

- f Disconnect the negative terminal on the battery during all work on the electrical system.
Please see the chapter "BATTERY" on Page 261.

Relays

Defective **relays** should be changed only by an authorized workshop.



In storage tray between the front seats

Sockets

Electrical accessories should preferably be connected to the 12 V sockets.

- f Please observe the maximum power consumption.

Note on operation

The tire filling compressor must be connected to the cigarette lighter.



In the passenger's footwell

Note on operation

The sockets and thus the connected electrical accessories function even if the ignition is switched off or the ignition key is withdrawn.

If the engine is not running and the accessories are switched on, the vehicle battery will be discharged.

Do not operate additional accessories for more than 5 minutes when engine is off. Continuing to do so may drain the battery such that it may go completely dead.

Maximum power consumption for both sockets together: 70 W.

Alarm system, central locking

The status of the central locking and alarm system is not changed by disconnecting the battery. When the battery is disconnected, the alarm system ceases to function.

Central locking overload protection

If the central locking system is operated more than ten times within a minute, further operation is blocked for 30 seconds.

Load switch-off after 2 hours or 7 days

If the ignition key is removed, loads which are switched on or are in standby mode (such as the luggage compartment light, interior light) are automatically switched off after approx. **2 hours**. The Radio/PCM is automatically switched off after approx. **10 minutes**.

If the vehicle is not started or unlocked with the remote control within **7 days**, the remote control standby function is switched off (to save the vehicle battery).

1. In this case, unlock the driver's door with the key at the door lock.
Leave the door closed in order to prevent the alarm system from being triggered.
2. Press **button 1** on the remote control.

The remote control is now activated again.

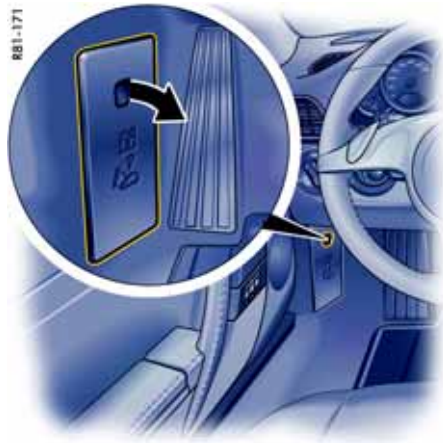

Replacing fuses

In order to prevent damage to the electrical system due to short circuits and overloads, the individual circuits are protected by fuses. The fuse box is located in the driver's footwell.



A - Plastic gripper
B - Spare fuses

1. Switch off the load with the defective fuse.
2. Pull off plastic cover at the finger hole (**arrow**). The **fuse plan** and **instructions for emergency unlocking of the luggage compartment lid** can be found on the inner side of the cover.
3. Remove the corresponding fuse from its slot using the plastic gripper **A** in order to check it. A blown fuse can be identified by the melted metal strip.

4. Replace only with fuses of the same rating. We recommend using genuine Porsche fuses for replacement.

Note

- f If a fuse blows repeatedly consult an authorized Porsche dealer.
- f Never try to "repair" fuses: you may cause serious damage to other parts of the electrical system.

Emergency unlocking of the luggage compartment lid

If the battery is discharged, the luggage compartment lid can be opened only with the aid of a donor battery.

Note

The engine **cannot** be started with this method.

f Please see the chapter "EMERGENCY STARTING WITH JUMPER CABLES" on Page 267.

Unlocking lid

1. Use the key to unlock the vehicle at the door lock.
2. Remove the plastic cover from the fuse box.
3. Pull out positive terminal **C** (red) in the fuse box using the plastic gripper **A** (yellow).

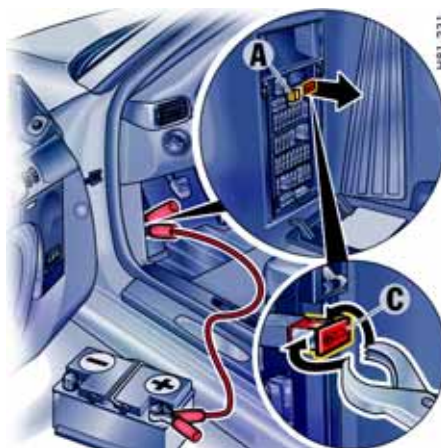

A - Plastic gripper (yellow)
C - Positive terminal (red)

4. Use a jumper cable to connect the positive terminal of the donor battery to the positive terminal **C** in the fuse box.

Note

If the vehicle was locked, the alarm horn will sound when the negative cable is connected.

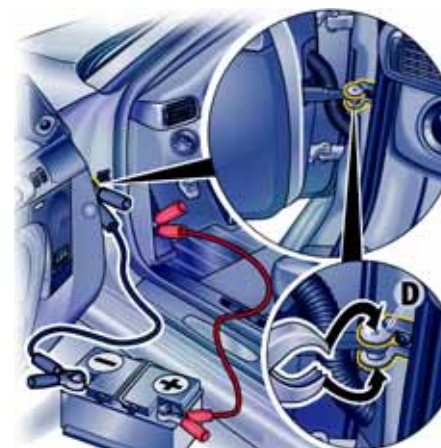

5. Use the black jumper cable to connect the negative terminal of the donor battery to the door arrester **D**.
6. Press button **2** on the remote control for approx. 2 seconds to unlock the luggage compartment lid. The alarm system is switched off.
7. Disconnect the negative cable first, then the positive cable.
8. Push positive terminal **C** into the fuse box and push on the plastic fuse box cover.

Battery

The battery is located in the luggage compartment under a black plastic cover.

- f Please see the chapter "EMERGENCY OPERATION – PULLING OUT THE IGNITION KEY" on Page 76.
- f Please see the chapter "EMERGENCY UNLOCKING OF THE LUGGAGE COMPARTMENT LID" on Page 260.



Risk of short circuit, fire and damage to alternator and electronic control units, resulting in serious personal injury or death.

- f Observe all warning notes on the battery.
- f Disconnect the negative terminal on the battery during all work on the electrical system.
- f Do not lay tools or other metal objects on the battery as they could cause a short circuit across the battery terminal.

Hydrogen gas generated by the battery could cause an explosion, resulting in serious personal injury or death.

- f Do not expose the battery to an open flame, electrical spark or a lit cigarette.
- f Do not wipe battery with a dry cloth.

Risk of serious personal injury or death and damage to the fabric, metal or paint.

- f Wear eye protection.
- f Do not allow battery acid to come in contact with your skin, eyes, fabric or painted surfaces.
- f If you get electrolyte, which is an acid, in your eyes or on your skin, immediately rinse with cold water for several minutes and call a doctor.
- f Spilled electrolyte must be rinsed off at once with a solution of baking soda and water to neutralize the acid.

Battery posts, terminals and related accessories contain lead and lead compounds, chemicals known to the State of California to cause cancer and reproductive harm.

- f Always protect your skin by washing thoroughly with soap and water.

Risk of explosion as a result of static charge, resulting in serious personal injury or death.

- f Do not wipe the battery with a dry cloth.
- f Eliminate potential electrostatic charge by touching the vehicle before touching the battery.

Charge state

A well-charged battery prevents starting problems and has a longer service life.

Traffic density, requirements regarding noise, exhaust gas and fuel consumption reduce the engine speed and, hence, the alternator output.

However, the large number of electrical loads has markedly increased the demand for electrical power.

In order to avoid discharging the battery unintentionally:

- f Switch off unnecessary electrical loads in city traffic, on short trips or in a line or traffic.
- f Always remove the ignition key from the ignition switch when leaving the car.
- f Avoid frequent operation of the convertible top and operation of the Porsche Communication Management system when the engine is not running.
- f In the cold season in particular or if the vehicle is used primarily for short journeys, it may be necessary to recharge the battery from time to time.

Battery care

- f Ensure that battery is securely mounted.
- f Keep terminals and connections clean and properly tightened.
Corrosion can be prevented by coating the terminals and connections with petroleum jelly or silicone spray.
- f Ensure that vent caps are securely tightened to prevent spillage.

Checking the electrolyte fluid level

The acid level should be checked more frequently by a qualified specialist workshop during the summer months and in predominantly warm countries.

Battery charging

Automotive batteries lose their efficiency when not in use.
The charge available in your battery can be measured with a battery hydrometer.
We recommend that the battery voltage be tested by your authorized Porsche dealer who has the appropriate equipment.

If the car is not driven for prolonged periods, the battery must be charged at least every 6 weeks. A discharged battery allows rapid formation of sulfates, leading to premature deterioration of the plates.

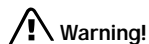

Hydrogen gas generated by the battery could cause an explosion, resulting in serious personal injury or death.

- f Charge battery in a well ventilated area.
 - f Never charge a frozen battery. It may explode because of gas trapped in the ice. Allow a frozen battery to thaw out first.
 - f If you get electrolyte, which is an acid, in your eyes or on your skin, immediately rinse with cold water for several minutes and call a doctor.
-

Slow battery charging

Your authorized Porsche dealer will be pleased to advise you about a suitable charger.

1. Always observe the instructions of the charger manufacturer.
Depending on the type of charger, the battery may have to be disconnected.
In this case, always disconnect the negative lead first, and then the positive lead – risk of short circuit!

Reconnect the leads in reverse order.

2. Before charging, cold batteries must be warmed up indoors.
 3. Frozen batteries must be thawed out first before being charged.
 4. When charging, ensure that there is adequate ventilation.
 5. Connect the charger to the battery.
Only plug into the mains and switch the charger on when it is connected up correctly.
 6. Switch on the charger.
 7. After charging, switch off the charger first and then disconnect it.
- f Please see the chapter "PUTTING VEHICLE INTO OPERATION" on Page 263.

Winter operation

The capacity and ability of the battery to store power decreases at low outside temperatures. Moreover, the battery is more heavily loaded in winter months, e.g. by the heated rear window, more frequent use of additional lights, the fans and the windshield wipers, etc.

- f Have the battery checked before the start of winter.

Maintenance note

Keep the battery well charged to prevent it from freezing.

A discharged battery can freeze at 23 °F (-5 °C), but a fully charged battery only freezes at -40 °F (-40 °C).

A frozen battery **must** always be thawed before connecting jump leads.

Replacing battery

The service life of the battery is subject to normal wear; it depends greatly on care, climatic conditions, and driving conditions (distances, loads).

- f Only use an original Porsche battery, with the correct part number, as a replacement.
- f Please observe the disposal instructions for batteries.

Putting vehicle into operation

After the battery is connected or after an **exhaustively discharged** battery is charged, the multifunctional PSM light lights up on the instrument panel and a message appears on the on-board computer to indicate a fault.

This fault can be remedied with a few simple steps:

1. Start the engine.
 2. With the vehicle stationary, perform a few steering movements to the left and right and then drive a short distance in a straight line until the multifunctional PSM light goes out and the message on the on-board computer disappears.
 3. If the warnings do **not** disappear, then:
Drive carefully to the nearest authorized Porsche dealer.
Have the fault remedied.
 4. After the warnings disappear:
Stop the vehicle in a suitable place.
- f Perform adaptation of the power windows:
Please see the chapter "STORING END POSITION OF THE WINDOWS" on Page 26.

Removing the battery

The required tool is in the tool kit.

The battery is located in the luggage compartment under a black plastic lid.

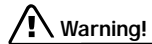

Warning!

Risk of damage to alternator and electronic control units.

- f Do not disconnect the battery while the engine is running.
This also applies to cars equipped with a battery main switch.
- f Never drive the car with a disconnected battery.

Risk of caustic burns from escaping acid.

- f Keep vent caps on to avoid spillage.
- f Do not tilt the battery when removing and installing it.

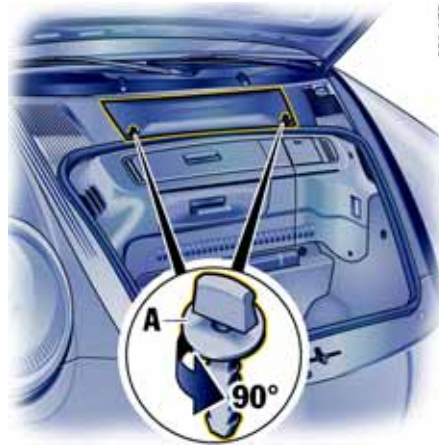

1. Switch off engine and all electrical loads.
2. Open turn-locks **A**.
Remove plastic lid.
3. Pull off central vent hose **C**.



Danger!

Risk of short circuit and explosion, resulting in serious personal injury or death.

- f Important: disconnect the negative (-) ground wire first, and then the positive (+) cable.



4. Important: disconnect the negative (-) ground wire first, and then the positive (+) cable - danger of short circuit!
5. Unscrew fastening screw **B**.
6. Remove battery.

Installing the battery

1. Put battery in and push it all the way to the stop.
2. Screw in fastening screw **B**.

 **Danger!**

Risk of short circuit and explosion, resulting in serious personal injury or death.

- f Important: connect the positive (+) cable first, and then the negative (-) ground wire.
3. Important: connect the positive (+) cable first, and then the negative (-) ground wire - danger of short circuit!
4. Push on central vent hose **C**.



Fitting the plastic lid

1. Insert the two outer hooks of the plastic lid into the eye mounts of the lid opening.
2. Lower the lid.
3. Using both hands, push the lid into the eye mounts without using force (if too much force is used, the hooks may jam and the panel will warp).
Make sure that the lid is correctly seated.

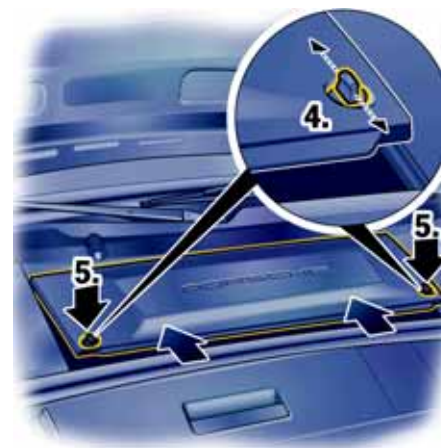

4. Turn the turn-locks so that they point in longitudinal direction.
5. Press the turn-locks down until they audibly engage.



801-175

3. Replace the cover and press together firmly. Please observe the disposal instructions for batteries.

Note

- f Please dispose batteries in compliance with any and all government regulations.

Replacing the remote-control battery

The battery should be changed when the range of the radio remote control becomes smaller or when the light-emitting diode no longer flashes when the remote control is operated.

1. Using your finger nail or a small screwdriver, carefully lift off the cover of the key grip (arrow).
2. Replace the battery (paying attention to the polarity).
Replacement battery – Lithium CR 2032, 3 volts.

Emergency Starting with Jumper Cables

If the battery is discharged, e.g. in winter or after the car has been parked for a long time, the battery of another car can be used for starting with the help of jumper cables.

Make sure the voltage of both batteries is the same. Both batteries must be 12 volt types. The capacity (Ampere hours, Ah) of the booster battery must not be substantially less than that of the discharged battery.

The discharged battery must be correctly connected to the vehicle's electrical system.

- f Please see the chapter "BATTERY" on Page 261.
- f Please see the chapter "EMERGENCY UNLOCKING OF THE LUGGAGE COMPARTMENT LID" on Page 260.

Note

- f Do not try to start the car by pushing or towing. Damage to the catalytic converters and other components of the car may result.



Warning!

Risk of short circuit, damage and explosion, resulting in serious personal injury or death.

- f Use only jumper cables of adequate diameter cross-section and fitted with completely insulated alligator clips.
- f Follow all warnings and instructions of the jumper cable manufacturer.
- f When connecting jumper cables, make sure that they cannot get caught in any moving parts in the engine compartment. The jumper cables must be long enough so that neither vehicles nor cables touch another.
- f The vehicles must not be in contact, otherwise current might flow as soon as the positive terminals are connected.
- f The cable clamps must not be allowed to contact each other when one end of the jumper cables are connected to a battery.
- f Ensure that tools or conductive jewellery (rings, chains, watch straps) do not come into contact with the positive jumper cable or the positive battery post.
- f Improper hook-up of jumper cables can ruin the alternator.

Danger of caustic burns from escaping acid.

- f Do not lean over the battery.

Danger of gas explosion.

- f Improper use of booster battery to start a vehicle may cause an explosion, resulting in serious personal injury or death.
- f Keep sources of ignition away from the battery, e.g. open flame, burning cigarettes or sparking due to cable contact or welding work.
- f A discharged battery can freeze even at 23 °F/ -5 °C. Before connecting jumper cables, a frozen battery must be thawed out.

Connect jumper cables in the following sequence:

Always observe the sequence below:

1. Connect the **positive lead (red)** to the positive terminal of the discharged battery first, then connect it to the positive terminal of the donor battery.
2. First connect the **negative cable (black)** to the negative terminal of the donor battery, then connect it to a suitable grounding point on the vehicle with the discharged battery. This grounding point must lie as far as possible from the battery.
For example, a solid metal part or the engine block are suitable grounding points.

If no suitable grounding points are to be found on either vehicle, the negative cable must carefully be connected directly to the negative terminal of the battery.

If a suitable grounding point is to be found only on the donor vehicle, the negative cable must first be connected to the terminal of the discharged battery, then to the grounding point of the donor vehicle.

3. Run the engine of the donor car at a higher speed.

4. Start the engine.
An attempted start using jumper cables should not last more than 15 seconds. Then allow a waiting period of at least one minute.

f Note

Before disconnecting the jumper cables, electrical loads such as the heated rear window and the heating fan blower should be switched on (the vehicle's lights must **not** be switched on). This reduces voltage peaks which may occur when disconnecting the jumper cables.

With the engine running, remove both jumper cables in reverse order.

Bulb chart

	Type, rating
Low beam	Philips, D2S 35W
Additional high beam without cornering light	H11, 55W
Additional high beam with cornering light	H7 LL, 55 W
Turn signal indicator light, side	WY5W
License plate light	C5W

Lights, Replacing Bulbs

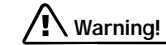

Risk of short circuit.

- f Always switch off the relevant consumer when changing bulbs.

Risk of serious personal injury or death. The Bi Xenon headlights are under high voltage when installed.

- f Be careful during all work in the area of the Bi Xenon headlights.

Risk of damage. Bulbs of a higher wattage can damage the lamp housing.

- f Only the bulbs shown in the chart may be used.
-

- f New bulbs must be clean and free from oil, grease and fingerprints. **Therefore, never touch bulbs with your bare hands.** Use a cloth or soft paper while replacing bulbs.

Headlights

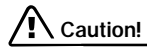

Caution!

Risk of damage to headlights due to excessive temperatures and abrasion.

- f To ensure optimum ventilation, do not cover the gap between headlight and body (e.g. "stone guards" or films).
- f Use soapy water only to clean light lenses and plastic headlight lenses. In no case may chemical cleaners or other volatile cleaning fluids be used.
- f To prevent scratches, do not rub with a dry or merely moist cloth, tissue or insect sponges.



8B1-176



8B1-177

Removing headlights

1. Unscrew plastic nut **A**.
Detach the side carpeting.
2. Remove rubber plug **B** from the unlocking opening.

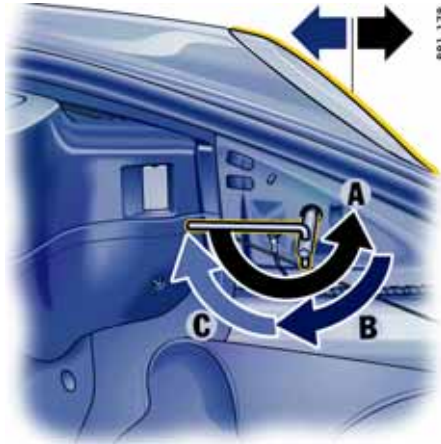

881-178

Installing

1. Insert headlight into the guide rails and push fully into the fender.
2. Push headlight to the rear and at the same time turn the socket wrench until it points horizontally to the rear **C**. The headlight locking device must perceptibly and audibly engage.
3. Insert the rubber plug into the unlocking opening and secure the carpet. Check the function of all lights.

3. Place socket wrench (tool kit) on the unlocking spindle.
The handle of the wrench should point horizontally to the rear.
4. Turn socket wrench approx. 180° **A**. The headlight is unlocked and pushed forward slightly during this process.
5. Turn socket wrench back until it is pointing vertically downward **B** and leave in position.
6. The headlight is now unlocked and can be pulled forward out of the fender.

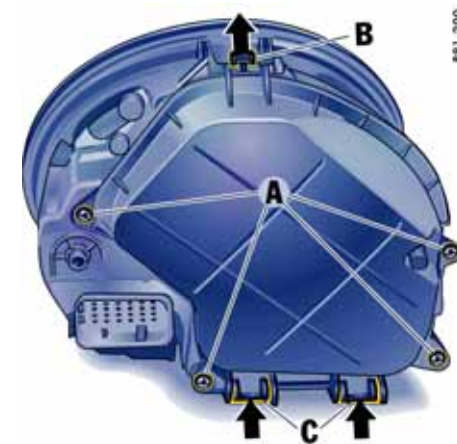

881-200

Low beam, high beam and additional high beam

Opening the lid of the headlight housing

1. Unscrew the 4 screws **A**.
2. First lift release tab **B**, then push both release tabs **C** upwards and take off lid.



**Changing bulb for low beam and high beam
(without cornering light)**

1. Turn the plug counter-clockwise (bayonet lock) and pull it off.
2. Disengage both fixing loops **A**.
3. Replace defective bulb **B**.
When doing so, ensure bulb is seated properly.
4. Engage both fixing loops **A**, push on plug and turn right as far as the stop.



**Changing bulb for additional high beam
(without cornering light)**

1. Turn the bulb holder.
Turn it counter-clockwise on the left headlight
and clockwise on the right headlight.
Take bulb holder out of the headlight housing.



2. Pull both plug release tabs apart.
Pull plug out of the bulb holder.
3. Replace the defective bulb with bulb holder.
4. Reassemble in reverse order.

Closing lid of headlight housing

1. Push on lid until it perceptibly engages.
2. Fasten lid with the 4 screws.



881-194

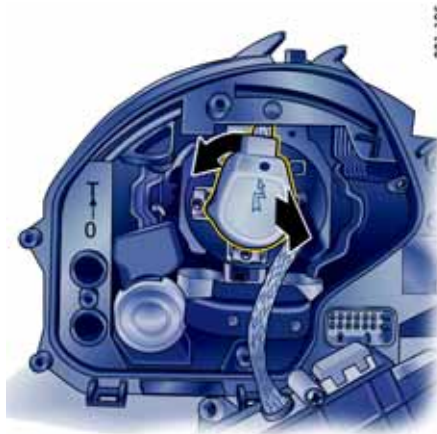

881-195



881-196

Changing bulb for low beam and high beam (with cornering light)

1. Undo the 3 screws on the control unit and remove the control unit.

2. Turn the plug counter-clockwise and pull it off.

3. Disengage both fixing clips.

4. Replace defective bulb.
When doing so, ensure bulb is seated properly.

5. Engage both fixing clips, push on plug and turn right as far as the stop.

6. Fit control unit and screw tight.

7. Push on housing cover until it perceptibly engages.

8. Fasten housing cover with the 4 screws.

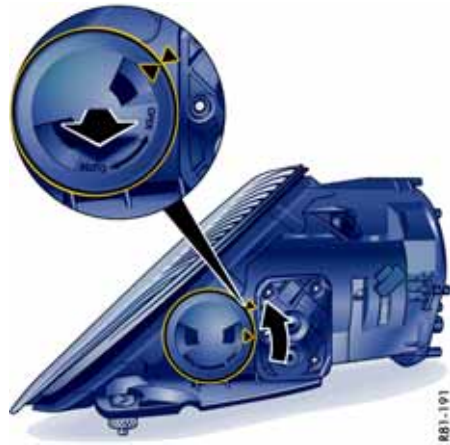

#81-191

**Changing bulb for additional high beam
(with cornering light)**

1. Turn cover counter-clockwise and take off.

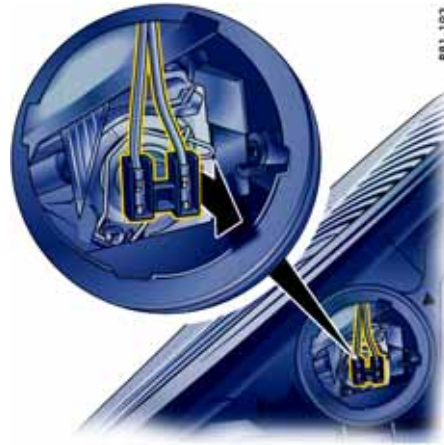

#81-193

2. Pull off plug.



#81-192

3. Disengage fixing clip.
4. Replace defective bulb.
5. Engage fixing clip, insert plug and close housing cover.

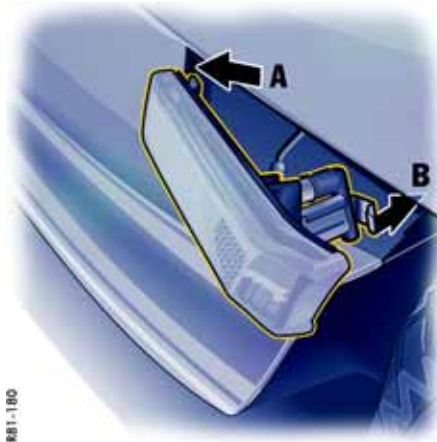

Changing bulb for side marker light

1. Remove the cap in the wheel housing liner with a screwdriver.
2. Insert the screwdriver into the opening in the wheel housing liner parallel to the turn signal housing (in direction of travel). By pressing with the screwdriver, disengage the securing spring of the turn signal housing.
3. Swivel out the indicator light and undo bulb holder (bayonet lock).
4. Remove the bulb from the holder and replace it. Insert holder. Check operation of the light.
5. Insert the turn signal's retaining lugs **A** into the side section at the front. Push in turn signal until the securing spring **B** is felt to engage.
6. Press the cap into the wheel housing liner.



883-181

Changing Light-Emitting Diodes and Long-Life Bulbs

The following lights are equipped with light-emitting diodes (LEDs) or long-life bulbs and cannot be replaced individually. Replacement also involves a greater amount of installation work.

- Side light, front,
 - Daytime driving lights,
 - Tail lights and
 - Additional brake lights
- f Have the defective light replaced at an authorized Porsche dealer.

Number Plate Light

Changing bulb

1. Unscrew both screws **A** and take off the light lens.
2. Remove defective bulb from between the contact springs and replace.
3. Reassemble in reverse order.
Check operation of the light.

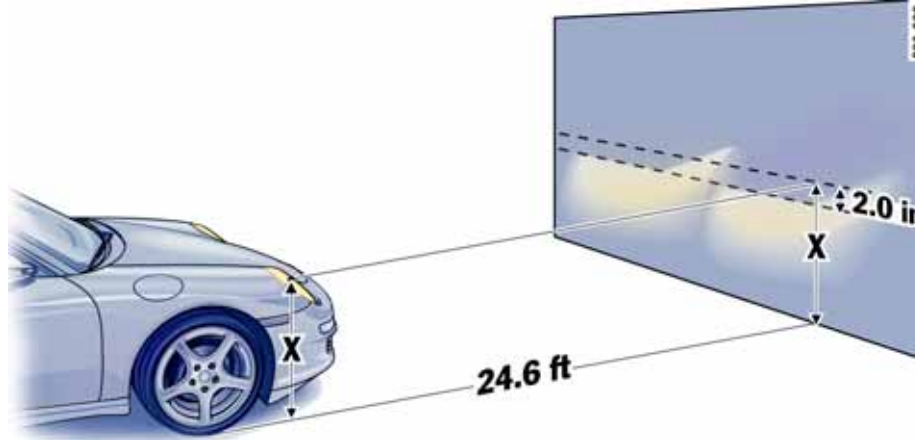

Adjusting Headlights

f Please see the chapter "LIGHTS, REPLACING BULBS" on Page 269.

Adjustment

The adjustment is made with the vehicle ready to drive and the fuel tank completely filled.

The driver's seat must be loaded by a person or a 165 lbs. (75 kg) weight and the tire pressures must meet the prescribed values.

After being loaded, the car must be rolled a few meters so that the suspension can settle.

For checking the headlight adjustment, the vertical position of the cutoff of the lowbeam (see fig.) has to be projected on a vertical screen (wall) in distance of 24.6 ft. (7.5 m) from the front lens of the headlamp.

The correct position of the cutoff is 2.0 in. (5 cm) at 24.6 ft. or 7.5 m (0.4°) below a horizontal line, **x** cm from ground to the center of the headlamp lens.

Lateral adjustment of the headlights should be carried out at a specialist workshop with an optical adjustment unit.

Distance

Visual aim shall be performed at not less than 24.6 ft./7.5 m (this value is a rounded down conversion from the 25-foot distance typical of field aim using a screen). The 24.6 ft./7.5 m distance is measured from the headlamp lens to the viewing screen.

Floor

The surface upon which the vehicle rests is flat and approximately level.

Screen

The screen upon which headlamp beams are projected is perpendicular to the floor and the vehicle's longitudinal axis, flat, uniformly light in color, unobstructed, and wide and high enough to accommodate the vehicle beam patterns to be aimed.

The screen should be wide enough to provide at least 3.3 ft. (1 m) of space outboard of the vehicle's headlamp spacing.



Adjustment screws

- f Detach side carpeting in luggage compartment.
Unscrew plastic nut **A**.
Open the cover of the appropriate adjustment screw.
The setting is adjusted by turning the hexagon socket screws right or left, as appropriate.



B - Headlight vertical adjustment

Vertical adjustment (screw B)

- f turn clockwise = beam moves down
turn counter-clockwise = beam moves up

Note

- f Do not alter the lateral adjustment.

Towing

Certain state statutes and local ordinances prohibit towing with a chain, rope or even a tow bar. In addition, damage to your vehicle may result from improper procedures. Consult your authorized Porsche dealer for details.

Vehicle towing

Flat bed towing is the preferred type of towing to be used on Porsche vehicles.

Under certain circumstances, wheel lifts may be used when the vehicle will not roll.

The vehicle must be towed with all four wheels off the ground, otherwise damage to the vehicle may result.

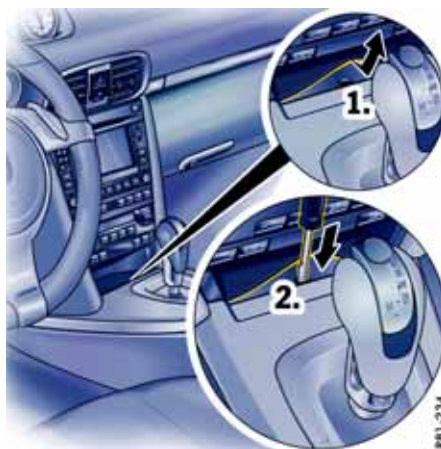

PDK selector lever emergency release

In the event of an electronics failure, the selector lever must be released for towing.

1. Lift up the rubber mat in the oddments tray.
2. Insert a screwdriver in the opening and press down until you feel it reach the limit position. The selector lever can now be moved to position **N**.

Towing hook

The towing hook **A** is contained in the tool box in the luggage compartment.



Caution!

Risk of damage to the vehicle.

- f Use the towing hook only for an emergency to remove the vehicle off the road. The towing hook is to be used only to pull the vehicle onto the flat bed, tractor or towing apparatus if the vehicle will roll freely. Under no circumstances is the vehicle to be secured using the towing hook.
- f Never use the towing hook to tow this or any other vehicle.
- f Bear in mind the limited ground clearance of your car on uneven surfaces.



Fitting towing hook

When fitting on the rear of the vehicle, the license plate must be removed.

1. Press the lower edge of the appropriate plastic cover into the bumper until the cover disengages.
2. Pull cover out of the bumper and let it hang by its thread.
3. Completely screw in the towing hook **A**.



Removing towing hook

1. Unscrew the towing hook **A**.

2. Insert plastic cover at the lower edge of the opening.
3. Fold the cover up and press on its upper edge to engage it in the bumper.

When removing on the rear of the vehicle, the license plate must be mouted.



Pulling vehicle onto flat bed

1. Position wooden ramps at the base of the flat bed to reduce the angle of the pull.
2. Reel in the hoist cable and check the underside of the vehicle for any interference.

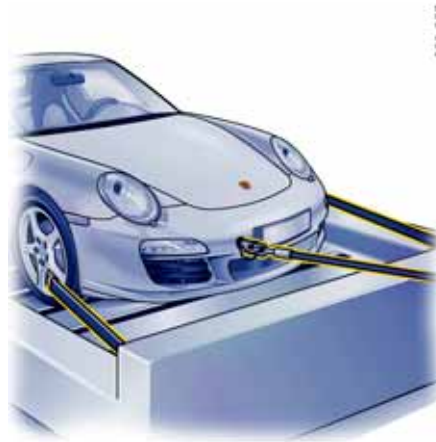

Tieing down vehicle on flat bed

1. Carefully feed towing straps through the opening in the **rear wheels**.
Make sure metal parts of straps do not damage rim.
Make sure the strap is flat over the rim bead.
Make sure brake backing plate is not damaged.
2. Secure straps to rear of flat bed.
3. Reel in hoist cable only far enough to tension tie-down straps.

4. Carefully feed towing straps through the opening in the **front wheels**.
Make sure metal parts of straps do not damage rim.
Make sure the strap is flat over the rim bead.
Make sure brake backing plate is not damaged.
5. Secure straps to front of flat bed.
6. Release tension on hoist cable, but do not disconnect.
Use hoist cable as a safety cable.

Vehicle Identification, Technical Data

Vehicle Identification	284
Technical Data	286
Diagrams	299

Vehicle Identification

When ordering spare parts or making inquiries, please always quote the vehicle identification number.

Vehicle data bank

The vehicle data bank is attached to the inside of the "Maintenance" booklet. It contains all important data about your vehicle.

Note

This data bank cannot be re-ordered if it is lost or damaged.

This label contains the following information:

1. Vehicle Identification No.
2. Type/Type description
3. Engine code/Transmission code
4. Paint No./Interior
5. Optional equipment



Vehicle identification number

In accordance with Federal Safety Regulations, the vehicle identification number of your car is located at the bottom left of the windshield frame and can be seen from the outside.

The vehicle identification number is in the luggage compartment under the battery cover and at the bottom left behind the windshield.

Removing the battery cover

- f Please see the chapter "BATTERY" on Page 261.



Safety compliance sticker

The safety compliance sticker is your assurance that your new Porsche complies with all applicable Federal Motor Vehicle Safety Standards which were in effect at the time the vehicle was manufactured.

- f The sticker also shows the month and year of production and the vehicle identification number of your car (perforations) as well as the **Gross Vehicle Weight Rating** and the **Gross Axle Weight Rating**.



Tire pressure plate

The tire pressure plate is attached to the left-hand door aperture.



Engine number

The engine number is stamped on the underside of the crankcase.

Technical Data

Engine data

	911 Carrera, 911 Carrera 4, 911 Targa 4	911 Carrera S, 911 Carrera 4S, 911 Targa 4S	911 Carrera S, 911 Carrera 4S, 911 Targa 4S
			Power kit Carrera
Type	MA 102 Horizontally opposed engine, liquid cooled	MA 101 Horizontally opposed engine, liquid cooled	MA 101S Horizontally opposed engine, liquid cooled
Number of cylinders	6	6	6
Bore	3.82 in./97 mm	4.02 in./102 mm	4.02 in./102 mm
Stroke	3.21 in./81.5 mm	3.05 in./77.5 mm	3.05 in./77.5 mm
Cubic capacity	220.5 cu. in./3614 cm ³	231.9 cu. in./3800 cm ³	231.9 cu. in./3800 cm ³
Net-horsepower at crankshaft speed	345 hp/254 kW 6500 rpm	385 hp/283 kW 6500 rpm	408 hp/300 kW 7300 rpm
Net torque at crankshaft speed	288 ft. lb./390 Nm 4400 rpm	310 ft. lb./420 Nm 4400 rpm	310 ft. lb./420 Nm 4400 - 5800 rpm
Engine oil consumption	up to 1.5 liters/1000 km (1.6 quarts/622 miles)	up to 1.5 liters/1000 km (1.6 quarts/622 miles)	up to 1.5 liters/1000 km (1.6 quarts/622 miles)

Tires, Rims, Tracks 911 Carrera, 911 Carrera S

		Tire	Rim	Rim offset	Track
Summer tires*	front	235/40 ZR 18 (91Y)	8 J x 18 H2	57 mm	58.5 in./1486 mm
	rear	265/40 ZR 18 (101Y) XL	10.5 J x 18 H2	60 mm	60.4 in./1534 mm
or	front	235/35 ZR 19 (87Y)	8 J x 19 H2	57 mm	58.5 in./1486 mm
	rear	295/30 ZR 19 (100Y) XL	11 J x 19 H2	67 mm	59.7 in./1516 mm
or	front	235/35 ZR 19 (87Y)	8.5 J x 19 H2	55 mm	58.5 in./1486 mm
	rear	305/30 ZR 19 (102Y) XL	11.5 J x 19 H2	67 mm	59.7 in./1516 mm
Snow tires	front	235/40 R 18 91V M+S	8 J x 18 H2	57 mm	58.5 in./1486 mm
	rear	265/40 R 18 97V M+S**	10.5 J x 18 H2	60 mm	60.4 in./1534 mm
or	front	235/35 R 19 87V M+S	8 J x 19 H2	57 mm	58.5 in./1486 mm
	rear	295/30 R 19 100V XL M+S	11 J x 19 H2	67 mm	59.7 in./1516 mm

The load capacity coefficient (e.g. "91") and maximum speed code letter (e.g. "Y") are minimum requirements.

Snow chains Can be mounted only on the rear wheels; **maximum speed 30 mph (50 km/h)**.

Use only Porsche authorized fine-link cross-type or edge chains.

Snow chain clearance can be guaranteed only on the tire + rim combination marked without spacers.**

Please see the chapter "SPACERS 911 CARRERA, 911 CARRERA S" on Page 255.

Tire and rim sizes Extensive tests are performed before specific tires and wheels are approved by Porsche. Your Porsche dealer has information about approved tires and wheels and is happy to assist you.

If aftermarket tires and/or wheels are installed which are not approved by Porsche, the vehicle's driveability, stability while in motion and handling characteristics might be impaired. Since Porsche has no data on such combinations, Porsche cannot stand behind the safety or durability of these aftermarket combinations.

* 911 Carrera S: Summer tires 19-inch only

Tires, Rims, Tracks 911 Carrera 4, 911 Carrera 4S, 911 Targa 4, 911 Targa 4S

		Tire	Rim	Rim offset	Track
Summer tires*	front	235/40 ZR 18 (91Y)	8 J x 18 H2	57 mm	58.6 in./1488 mm
	rear	295/35 ZR 18 (99Y)	11 J x 18 H2	51 mm	60.9 in./1548 mm
or	front	235/35 ZR 19 (87Y)	8 J x 19 H2	57 mm	58.6 in./1488 mm
	rear	305/30 ZR 19 (102Y) XL	11 J x 19 H2	51 mm	60.9 in./1548 mm
or	front	235/35 ZR 19 (87Y)	8.5 J x 19 H2	55 mm	58.6 in./1488 mm
	rear	305/30 ZR 19 (102Y) XL	11.5 J x 19 H2	50 mm	60.9 in./1548 mm
Snow tires	front	235/40 R 18 91V M+S	8 J x 18 H2	57 mm	58.6 in./1488 mm
	rear	295/35 R 18 99V M+S**	11 J x 18 H2	51 mm	60.9 in./1548 mm
or	front	235/35 R 19 87V M+S	8 J x 19 H2	57 mm	58.6 in./1488 mm
	rear	295/30 R 19 100V XL M+S**	11 J x 19 H2	51 mm	60.9 in./1548 mm

The load capacity coefficient (e.g. "91") and maximum speed code letter (e.g. "Y") are minimum requirements.

Snow chains Can be mounted only on the rear wheels; **maximum speed 30 mph (50 km/h)**.

Use only Porsche authorized fine-link cross-type or edge chains.

Snow chain clearance can be guaranteed only on the tire + rim combination marked.**

Tire and rim sizes Extensive tests are performed before specific tires and wheels are approved by Porsche. Your Porsche dealer has information about approved tires and wheels and is happy to assist you.

If aftermarket tires and/or wheels are installed which are not approved by Porsche, the vehicle's driveability, stability while in motion and handling characteristics might be impaired. Since Porsche has no data on such combinations, Porsche cannot stand behind the safety or durability of these aftermarket combinations.

* 911 Carrera 4S, 911 Targa 4S: Summer tires 19-inch only

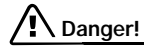

Danger!

Installation of sizes not authorized by Porsche may have a dangerous effect on the driving stability and could result in serious personal injury or death.

f Before mounting new tires, check with your Porsche dealer about the current release status.

Tire Pressures for cold tires (68 °F / 20 °C)

Summer and snow tires 911 Carrera, 911 Carrera S

		partially loaded (up to 2 persons without luggage)	fully loaded (as of 2 persons with luggage)
18 inch wheels	front	34 psi (2.3 bar)	37 psi (2.5 bar)
	rear	38 psi (2.6 bar)	44 psi (3.0 bar)
19 inch wheels	front	34 psi (2.3 bar)	37 psi (2.5 bar)
	rear	40 psi (2.7 bar)	44 psi (3.0 bar)

Summer and snow tires 911 Carrera 4, 911 Carrera 4S, 911 Targa 4, 911 Targa 4S

		partially loaded (up to 2 persons without luggage)	fully loaded (as of 2 persons with luggage)
18 inch wheels	front	34 psi (2.3 bar)	37 psi (2.5 bar)
	rear	37 psi (2.5 bar)	44 psi (3.0 bar)
19 inch wheels	front	34 psi (2.3 bar)	37 psi (2.5 bar)
	rear	37 psi (2.5 bar)	44 psi (3.0 bar)

These tire filling pressures apply only to the tire makes and types approved by Porsche.

Please see the chapter "TIRES/WHEELS" on Page 235. Please see the chapter "TPM TIRE PRESSURE MONITORING" on Page 143.

Capacities

Use only fluids and fuels authorized by Porsche. Your authorized Porsche dealer will gladly advise you.
Your Porsche has been designed so that it is not necessary to mix any additives with oils or fuels.

Engine	Oil change quantity with oil filter approx. 7.9 quarts / 7.5 liters Please see the chapter "ENGINE OIL" on Page 208.
Coolant	approx. 7.63 - 8.32 U.S. gallons / 28.9 - 31.5 liters
Manual transmission and differential	approx. 3.17 quarts / 3.0 liters transmission oil Mobilube PTX Formula A (SAE 75W-90) GL 4.5
Porsche Doppelkupplung Wheel set	approx. 3.12 quarts / 2.95 liters ATF transmission oil Mobilube PTX Formula A (SAE 75W-90) GL 4.5
Porsche Doppelkupplung Clutch/hydraulic fluid	approx. 5.49 quarts / 5.2 liters Pentosin Gear Oil FFL 3
Fuel tank	911 Carrera, 911 Carrera S: approx. 16.9 U.S. gallons / 64 liters 911 Carrera 4, 911 Carrera 4S, 911 Targa 4, 911 Targa 4S: approx. 17.7 U.S. gallons / 67 liters
Fuel quality	Your engine is designed to provide optimum performance and fuel economy using unleaded premium fuel with an octane rating of 98 RON (93 CLC or AKI) . Porsche therefore recommends the use of these fuels in your vehicle. Porsche also recognizes that these fuels may not always be available. Be assured that your vehicle will operate properly on unleaded premium fuels with octane numbers of at least 95 RON (90 CLC or AKI) , since the engine's "Electronic Oktane™ knock control" will adapt the ignition timing, if necessary.
Power steering	approx. 1.35 quarts / 1.27 liters hydraulic fluid Pentosin CHF 11 S [®] or Pentosin CHF 202 [®]
Brake fluid	0.48 quarts / 0.45 liters; use only Original Porsche brake fluid
Windshield washer	approx. 6.3 quarts / 6 liters with headlight washer

Weights Coupé

911 Carrera

	Manual transmission	Porsche Doppelkupplung
Empty weight (depending on equipment)	1415 kg to 1515 kg 3120 lbs. to 3340 lbs.	1445 kg to 1545 kg 3186 lbs. to 3406 lbs.
Maximum gross weight	4012 lbs./1820 kg	4079 lbs./1850 kg
Maximum axle load, front*	1709 lbs./775 kg	1709 lbs./775 kg
Maximum axle load, rear*	2601 lbs./1180 kg	2601 lbs./1180 kg
Maximum useful load, Roof Transport System**	165 lbs./75 kg	165 lbs./75 kg

911 Carrera S

	Manual transmission	Porsche Doppelkupplung
Empty weight (depending on equipment)	1425 kg to 1520 kg 3142 lbs. to 3351 lbs.	1455 kg to 1550 kg 3208 lbs. to 3417 lbs.
Maximum gross weight	4034 lbs./1830 kg	4101 lbs./1860 kg
Maximum axle load, front*	1709 lbs./775 kg	1709 lbs./775 kg
Maximum axle load, rear*	2601 lbs./1180 kg	2601 lbs./1180 kg
Maximum useful load, Roof Transport System**	165 lbs./75 kg	165 lbs./75 kg

* The maximum gross weight must not be exceeded.

Note: If additional accessories are installed, the useful load will be correspondingly less.

** Use only Original Porsche Roof Transport System.

Weights Coupé

911 Carrera 4

Manual transmission

Porsche Doppelkupplung

Empty weight (depending on equipment)

1470 kg to 1565 kg
3241 lbs. to 3450 lbs.

1500 kg to 1595 kg
3307 lbs. to 3516 lbs.

Maximum gross weight

4123 lbs./1870 kg

4189 lbs./1900 kg

Maximum axle load, front*

1819 lbs./825 kg

1819 lbs./825 kg

Maximum axle load, rear*

2690 lbs./1220 kg

2690 lbs./1220 kg

Maximum useful load, Roof Transport System**

165 lbs./75 kg

165 lbs./75 kg

911 Carrera 4S

Manual transmission

Porsche Doppelkupplung

Empty weight (depending on equipment)

1480 kg to 1570 kg
3263 lbs. to 3461 lbs.

1510 kg to 1610 kg
3329 lbs. to 3527 lbs.

Maximum gross weight

4145 lbs./1880 kg

4211 lbs./1910 kg

Maximum axle load, front*

1819 lbs./825 kg

1819 lbs./825 kg

Maximum axle load, rear*

2690 lbs./1220 kg

2690 lbs./1220 kg

Maximum useful load, Roof Transport System**

165 lbs./75 kg

165 lbs./75 kg

* The maximum gross weight must not be exceeded.

Note: If additional accessories are installed, the useful load will be correspondingly less.

** Use only Original Porsche Roof Transport System.

Weights Cabriolet

911 Carrera

	Manual transmission	Porsche Doppelkupplung
Empty weight (depending on equipment)	1500 kg to 1575 kg 3307 lbs. to 3472lbs.	1530 kg to 1605 kg 3373 lbs. to 3538 lbs.
Maximum gross weight	4145 lbs./1880 kg	4211 lbs./1910 kg
Maximum axle load, front*	1709 lbs./775 kg	1709 lbs./775 kg
Maximum axle load, rear*	2690 lbs./1220 kg	2690 lbs./1220 kg

911 Carrera S

	Manual transmission	Porsche Doppelkupplung
Empty weight (depending on equipment)	1510 kg to 1580 kg 3329 lbs. to 3483 lbs.	1540 kg to 1610 kg 3395 lbs. to 3549 lbs.
Maximum gross weight	4167 lbs./1890 kg	4233 lbs./1920 kg
Maximum axle load, front*	1709 lbs./775 kg	1709 lbs./775 kg
Maximum axle load, rear*	2690 lbs./1220 kg	2690 lbs./1220 kg

* The maximum gross weight must not be exceeded.

Note: If additional accessories are installed, the useful load will be correspondingly less.

Weights Cabriolet

911 Carrera 4

Empty weight (depending on equipment)

Maximum gross weight

Maximum axle load, front*

Maximum axle load, rear*

Manual transmission

1555 kg to 1625 kg

3428 lbs. to 3583 lbs.

4255 lbs./1930 kg

1819 lbs./825 kg

2690 lbs./1220 kg

Porsche Doppelkupplung

1585 kg to 1655 kg

3494 lbs. to 3649 lbs.

4321 lbs./1960 kg

1819 lbs./825 kg

2690 lbs./1220 kg

911 Carrera 4S

Empty weight (depending on equipment)

Maximum gross weight

Maximum axle load, front*

Maximum axle load, rear*

Manual transmission

1565 kg to 1630 kg

3450 lbs. to 3594 lbs.

4277 lbs./1940 kg

1819 lbs./825 kg

2690 lbs./1220 kg

Porsche Doppelkupplung

1595 kg to 1660 kg

3516 lbs. to 3660 lbs.

4343 lbs./1970 kg

1819 lbs./825 kg

2690 lbs./1220 kg

* The maximum gross weight must not be exceeded.

Note: If additional accessories are installed, the useful load will be correspondingly less.

Weights Targa

911 Targa 4

	Manual transmission	Porsche Doppelkupplung
Empty weight (depending on equipment)	1530 kg to 1605 kg 3373 lbs. to 3538 lbs.	1560 kg to 1635 kg 3439 lbs. to 3605 lbs.
Maximum gross weight	4211 lbs./1910 kg	4277 lbs./1940 kg
Maximum axle load, front*	1819 lbs./825 kg	1819 lbs./825 kg
Maximum axle load, rear*	2690 lbs./1220 kg	2690 lbs./1220 kg

911 Targa 4S

	Manual transmission	Porsche Doppelkupplung
Empty weight (depending on equipment)	1540 kg to 1610 kg 3395 lbs. to 3549 lbs.	1570 kg to 1640 kg 3461 lbs. to 3616 lbs.
Maximum gross weight	4233 lbs./1920 kg	4299 lbs./1950 kg
Maximum axle load, front*	1819 lbs./825 kg	1819 lbs./825 kg
Maximum axle load, rear*	2690 lbs./1220 kg	2690 lbs./1220 kg

* The maximum gross weight must not be exceeded.

Note: If additional accessories are installed, the useful load will be correspondingly less.

Driving Performance Coupé

At DIN empty weight and half load, without performance-inhibiting extra equipment

			Powerkit Carrera	
911 Carrera	Manual transmission	PDK transmission		
Top track speed	179.6 mph (289 km/h)	178.3 mph (287 km/h)		
Acceleration 0 - 60 mph	4.7 seconds	4.5 seconds		
Acceleration 0 - 60 mph with Sport +		4.3 seconds		
Acceleration 0 - 100 km/h (62 mph)	4.9 seconds	4.7 seconds		
Acceleration 0 - 100 km/h (62 mph) with Sport +		4.5 seconds		
911 Carrera S	Manual transmission	PDK transmission	Manual transmission	PDK transmission
Top track speed	187.7 mph (302 km/h)	186.4 mph (300 km/h)	190.8 mph (307 km/h)	189.5 mph (305 km/h)
Acceleration 0 - 60 mph	4.5 seconds	4.3 seconds	4.4 seconds	4.2 seconds
Acceleration 0 - 60 mph with Sport +		4.1 seconds		4.0 seconds
Acceleration 0 - 100 km/h (62 mph)	4.7 seconds	4.5 seconds	4.6 seconds	4.4 seconds
Acceleration 0 - 100 km/h (62 mph) with Sport +		4.3 seconds		4.2 seconds
911 Carrera 4	Manual transmission	PDK transmission		
Top track speed	176.5 mph (284 km/h)	175.2 mph (282 km/h)		
Acceleration 0 - 60 mph	4.8 seconds	4.6 seconds		
Acceleration 0 - 60 mph with Sport +		4.4 seconds		
Acceleration 0 - 100 km/h (62 mph)	5.0 seconds	4.8 seconds		
Acceleration 0 - 100 km/h (62 mph) with Sport +		4.6 seconds		
911 Carrera 4S	Manual transmission	PDK transmission	Manual transmission	PDK transmission
Top track speed	184.5 mph (297 km/h)	183.3 mph (295 km/h)	187.7 mph (302 km/h)	186.4 mph (300 km/h)
Acceleration 0 - 60 mph	4.5 seconds	4.3 seconds	4.4 seconds	4.2 seconds
Acceleration 0 - 60 mph with Sport +		4.1 seconds		4.0 seconds
Acceleration 0 - 100 km/h (62 mph)	4.7 seconds	4.5 seconds	4.6 seconds	4.4 seconds
Acceleration 0 - 100 km/h (62 mph) with Sport +		4.3 seconds		4.2 seconds

Driving Performance Cabriolet, Targa

At DIN empty weight and half load, without performance-inhibiting extra equipment

	Powerkit Carrera			
911 Carrera	Manual transmission	PDK transmission		
Top track speed	179.6 mph (289 km/h)	178.3 mph (287 km/h)		
Acceleration 0 - 60 mph	4.9 seconds	4.7 seconds		
Acceleration 0 - 60 mph with Sport +		4.5 seconds		
Acceleration 0 - 100 km/h (62 mph)	5.1 seconds	4.9 seconds		
Acceleration 0 - 100 km/h (62 mph) with Sport +		4.7 seconds		
911 Carrera S	Manual transmission	PDK transmission	Manual transmission	PDK transmission
Top track speed	187.7 mph (302 km/h)	186.4 mph (300 km/h)	190.8 mph (307 km/h)	189.5 mph (305 km/h)
Acceleration 0 - 60 mph	4.7 seconds	4.5 seconds	4.6 seconds	4.4 seconds
Acceleration 0 - 60 mph with Sport +		4.3 seconds		4.2 seconds
Acceleration 0 - 100 km/h (62 mph)	4.9 seconds	4.7 seconds	4.8 seconds	4.6 seconds
Acceleration 0 - 100 km/h (62 mph) with Sport +		4.5 seconds		4.4 seconds
911 Carrera 4, 911 Targa 4	Manual transmission	PDK transmission		
Top track speed	176.5 mph (284 km/h)	175.2 mph (282 km/h)		
Acceleration 0 - 60 mph	5.0 seconds	4.8 seconds		
Acceleration 0 - 60 mph with Sport +		4.6 seconds		
Acceleration 0 - 100 km/h (62 mph)	5.2 seconds	5.0 seconds		
Acceleration 0 - 100 km/h (62 mph) with Sport +		4.8 seconds		
911 Carrera 4S, 911 Targa 4S	Manual transmission	PDK transmission	Manual transmission	PDK transmission
Top track speed	184.5 mph (297 km/h)	183.3 mph (295 km/h)	187.7 mph (302 km/h)	186.4 mph (300 km/h)
Acceleration 0 - 60 mph	4.7 seconds	4.5 seconds	4.6 seconds	4.4 seconds
Acceleration 0 - 60 mph with Sport +		4.3 seconds		4.2 seconds
Acceleration 0 - 100 km/h (62 mph)	4.9 seconds	4.7 seconds	4.8 seconds	4.6 seconds
Acceleration 0 - 100 km/h (62 mph) with Sport +		4.5 seconds		4.4 seconds

Dimensions

	911 Carrera, 911 Carrera S	911 Carrera 4, 911 Carrera 4S 911 Targa 4, 911 Targa 4S
Length	175.83 in./4466 mm	175.83 in./4466 mm
Width	71.2 in./1808 mm	72.9 in./1852 mm
With with door mirrors	76.9 in./1952 mm	76.9 in./1952 mm
Height	51.6 in./1310 mm	51.6 in./1310 mm
Wheelbase	92.5 in./2350 mm	92.5 in./2350 mm
Ground clearance		
at maximum gross weight	4.45 in./113 mm	4.49 in./114 mm
Turning circle	35.8 ft./10.9 m	35.8 ft./10.9 m
Vehicles with PASM		
Height	51.2 in./1300 mm	51.2 in./1300 mm
Ground clearance		
at maximum gross weight	911 Carrera: 4.21 in./107 mm 911 Carrera S: 4.33 in./110 mm	911 Carrera 4, 911 Targa 4: 4.13 in./105 mm 911 Carrera 4S, 911 Targa 4S: 4.25 in./108 mm
Vehicles with Sports chassis		
Height	50.79 in./1290 mm	50.79 in./1290 mm
Ground clearance		
at maximum gross weight	3.94 in./100 mm	3.9 in./99 mm

Diagrams

MA 102, Engine diagram at full power, 911 Carrera, 911 Carrera 4, 911 Targa 4

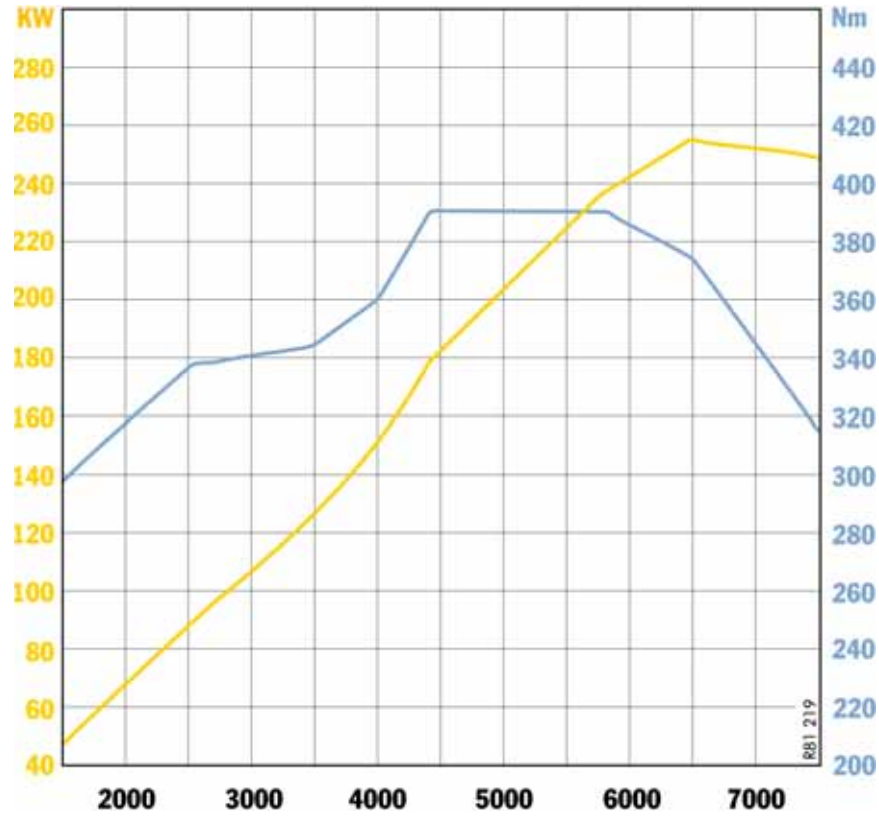

MA 101, Engine diagram at full power, 911 Carrera S, 911 Carrera 4S, 911 Targa 4S

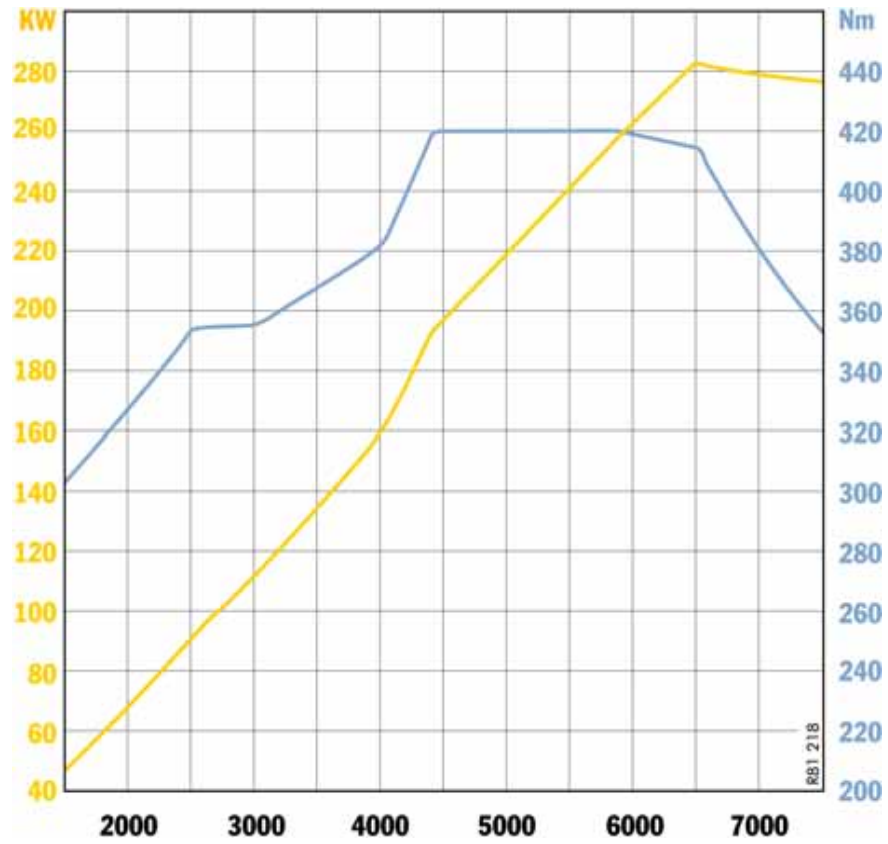

300 Diagrams

A		
ABS (antilock brake system)	61	
Warning light	62	
Adaptive sports seat	31	
Adjusting Headlights.....	278	
Advanced Airbag.....	45	
Air conditioning compressor	106, 108	
Air conditioning system	106	
Air distribution	106, 108	
Air filter.....	222	
Air intake.....	109	
Airbag		
Advanced	45	
Cleaning covers	230	
Deactivation device	49	
Function	45	
Maintenance	48	
Warning light	48, 56	
Airbag Systems	44	
Alarm system	23, 100	
Deactivating passenger compartment		
monitoring.....	24	
Fault indication.....	24	
Function indication	23	
Not active	258	
Alcantara, cleaning	231	
Antenna	100, 225	
Antifreeze	207	
Antifreeze in coolant	207	
Antilock brake system (ABS)	61	
Warning light	62	
Ashtray	89	
Assembly aids for wheel changes.....	249	
Audio operation	98, 99	
Auto-button, air conditioning.....	106	
Automatic		
Air conditioning system.....	106	
Anti-glare mirrors	28	
Car washes	225	
Door locking	18, 22	
Garage door	78	
Headlight adjustment	81	
Speed control	86, 87, 116	
Transmission	170	
Automatic locking retractor.....	53	
Automatic speed control.....	116	
Indicator light.....	116	
Average consumption.....	127, 157	
Average speed	127, 157	
B		
Backrest		
Adjustment	30	
Release	30	
Battery.....	261	
Care.....	262	
Charge state.....	261	
Charging	262	
Putting vehicle into operation	263	
Remote control	266	
Removing	264	
Replacing	263	
Warning light.....	124	
Winter operation.....	263	
Before driving off	8, 9	
Belts	41	
Cleaning	231	
Height adjustment	43	
Tensioner	41	
Warning light.....	42	
Blower adjustment.....	109	
Blower speed adjustment.....	107	
Brake		
Break in.....	10	
Pads	60	
Pedal.....	59	
Wear	60	
Brake fluid		
Changing	213	
Checking level.....	212	
Level	212	
Warning light	213	
Brake light	277	
Brake light, additional.....	277	
Brakes	212	
Brake circuit division warning light	213	
Brake warning light.....	125	
Fluid	212, 290	
Fluid warning light.....	213	
Function	58	
New brake pads or linings.....	60	
Pads	10	
Parking brake.....	57	
Porsche Ceramic Composite Brake		
(PCCB)	4	
Roller brake tester.....	63	
Test stand	68	
Break in brakes.....	10	
Break in hints.....	10	
Bulbs, replacing	269	

C

Cabriolet	181
Capacities	290
Car care	224
Car telephone	100
Car washes	225
Carpet	230
Catalytic converters	219
Cautions	206, 234
Central locking	19, 258
Automatic relocking	19
Emergency operation	20
Fault indication	21
Overload protection	21, 258
Central locking button	21
Central vents	109
Central warning light	125
Changing bulb	277
Changing light-emitting diodes (LEDs)	277
Changing wheels	249
Check engine	
Warning light	125
Check engine warning light	125
Opening the oil filler cap	209
Checking pressure	250
Child restraint systems	50
Anchorage	55
Direction of installation	51
Child seat bracket	54
Chime	80
CHRONO Stopwatch	136
Cigarette lighter	90
Circulating-air button	107
Clock	123, 156

Clothes hook	91
Clutch	62, 168
Clutch pedal	62
Combination filter	222
Comfort seat	31
Coming home mode	81
Communication management	98
Compact disc	
Player	99
Storage	92
Compartment monitoring	23
Compressor	96
Convertible top	181
Care	226
Closing	182
Emergency operation	183
Opening	182
Preconditions for operation	182
Coolant	120, 207
Checking	207
Level	207
Temperature gage	120
Topping off	207
Warning light	120
Cooling system	120, 207
Warning light	120
Cornering light	
Indicator light	119
Crankcase ventilation	219
Cruise control	86, 87, 124
Cupholder	88

D

Data bank	284
Daytime driving lights	80
Changing bulbs	277
On-board computer	156
Defrosting windows	29, 107
Diagnostic socket	11
Dimensions	298
Direction indicator light, front	277
Door	18
Handles	18
Locks	18, 226
Mirror	28
Mirror heating	29
Mirrors	27
Windows	18, 26, 181, 228
Drive-Off Assistant	169
Driving	
Hints	8
Performance	296
Winter	175
Driving off	
Drive-Off Assistant	169
Launch Control	173
Drop-center rim	245
Dynamometer testing	63

E

Electrical system	257
Emergency flasher switch	79
Emergency operation	
Central locking	20
Convertible top	183
Ignition key	76

Lids	260	Exhaust		G	
Lifting/Sliding roof	179	Pipes	5	Garage	
Tank flap	215	System.....	57	Door	78
Emergency service	234	Tailpipes, stainless steel.....	229	Door opener	103
Emergency starting with		External antenna	100	Lift	254
jumper cables.....	267, 268	F		Gear display	112, 114
Emission control system	125, 218, 219	Fabric linings	230	Gear shift indicator	119
Engine		Filler flap	215	Glass rear hatch.....	200
Checking the oil level.....	153	Filling pressure, tire.....	289	Glass rear hatch (Targa)	
Diagram	299	Fire extinguisher	102	Unlocking	16
Exhaust.....	5	Flat tire	251	Glass roof.....	200
Number.....	285	Floor mats.....	230	Glove compartment.....	92
Oil consumption.....	10, 208	Fluids	222	Gong.....	14, 75, 80, 129
Oil level.....	208	Fluids and fuels.....	290	Ground clearance.....	5
Oil level indicator	153	FM reception	98		
Oil pressure.....	124	Fog light, rear	80	H	
Oil temperature.....	116	Footbrake.....	58	Handbrake	57
Oils	208, 290	Four-wheel drive.....	63	Hardtop	194
Speeds	10	Fresh air intake.....	109	Putting on.....	196
Starting	77	Front lid	93, 94	Removing	194
Stopping	78	Fuel	122, 215	Head restraints	30
Engine compartment		Containers.....	5, 217	Headlights	270
Blower	78, 120	Economy	214	Adjusting	278, 279
Blower fan.....	120	Evaporation control	217	Beam adjustment	81
Care	227	Fuels containing ethanol.....	217	Cleaning system.....	83, 220
Lid	93, 94	Level gage	122	Flasher	82
Lid warning light.....	93	Level warning light	122	Heated rear window	29
Engine oil		Recommendation	216, 217	Heated rear window/Door mirror heating	110
Change	210	Recommendations	216	Heater.....	106
Consumption	10	Tank	216	High beam	
Performance class.....	211	Function keys	39	Indicator light.....	119
Recommendation	210	Fuses, replacing	259	Lever.....	80
Topping off.....	209			High-pressure cleaning units.....	224
Viscosity	211			Home mode.....	81

HomeLink.....	103
Hoods.....	93, 94
Horn.....	12, 19, 21
Hot exhaust pipes.....	5
I	
Ignition key.....	74
Emergency operation.....	76
Ignition lock.....	74
Withdrawing ignition key, PDK transmission.....	172
Immobilizer.....	15
Indicator lights.....	112, 114
INFO Warning messages.....	132
Instrument	
Illumination.....	116
Lights.....	80
Panel.....	112, 114, 158
Interior lights.....	71
Interior mirror.....	28
J	
Jumper cables.....	267
K	
Key codes.....	15
Key-operated airbag deactivation device.....	49
Keys.....	15, 16
L	
LATCH System.....	54
Launch Control.....	173
Leather care.....	230

License plate light.....	80
Lids.....	94
Emergency unlocking.....	260
Lifting vehicle.....	254
Lifting/sliding roof.....	178
Light	
Daytime driving.....	80
Flasher.....	80, 82, 119
Low beam.....	80, 82
Sensor for instrument illumination.....	112, 114
Switch.....	80, 82
Light alloy wheels	
Inscription.....	245
Lights	
Care.....	229
Headlight beam adjustment.....	81
LIMIT Acoustic warning signal for speed limit.....	129
Load switch-off.....	258
Loading information.....	246
Locking.....	19
Conditions.....	21
Locking retractor.....	53
Low beam.....	82
Lowering.....	56
Luggage carrier.....	291, 292
Luggage compartment.....	95, 97
Lid.....	93
Lid warning light.....	93
Unlocking lid.....	16
Luggage compartment/ engine compartment lid, warning lights.....	93
Luggage rack.....	204

M	
Maintenance.....	206
Make-up mirror.....	40
Maximum permitted engine speeds.....	10
Manual transmission.....	168
Mirror	
Folding in.....	28
Heating.....	29, 110
Inside.....	27
Mirrors.....	27, 73
Anti-glare.....	28
Multi-functional steering wheel.....	39
N	
Navigation.....	98
Selection field, on-board computer.....	142
Notes on	
Car care.....	224
Maintenance.....	206
Number plate light.....	80, 277
O	
Octane rating.....	216, 217
Odometer.....	117
Off delay.....	81
Oil.....	208
Change.....	210
Checking level.....	153
Consumption.....	10
Level checks.....	208
Level indicator.....	153
Pressure.....	124
Recommendation.....	210

Temperature.....	116	Parking light	80, 82	Selector lever emergency release	280
Topping off engine oil.....	209	Particle filter	222	Selector lever position	170, 172
OIL Display and measurement of the		Passenger compartment monitoring.....	23	Shifting gears on the steering wheel	173
engine oil level.....	153	PDK transmission.....	170	Sport mode	172
On-board computer	126	Drive-Off Assistant.....	169	Transmission fluid	222
Basic settings.....	127, 155	Driving in winter	175	Porsche Stability Management (PSM).....	66
Calling on-board computer functions.....	127	Faults	171	Information light	68
Functions and display possibilities	127	Kickdown.....	173	Porsche traction management (PTM)	63
General information.....	156, 157	Launch Control.....	173	Power steering fluid level	221, 290
Language versions	155	Manual selection mode	174	Power windows	18, 181
Operation, controls	126	Reduced driving program.....	176	Practical tips.....	234
Selecting a radio station	142	Selector lever emergency release	280	Putting vehicle into operation	263
Setting the clock.....	156	Selector lever positions	172		
Switching daytime driving lights on/off..	156	Shifting gears on the steering wheel.....	173	R	
Switching on navigation	142	Sport mode	172	Radiator fan	78, 208
Tire pressure warnings	149	Transmission fluid	222	Radio reception.....	98
Warnings and messages.....	158	Warning messages	176	Rain sensor	83, 85
On-board literature	2	Pen holder	92	Range on remaining fuel	127, 157
Operating voice control	126	Plastic parts	229	Reading light.....	71
Operating your Porsche in other Countries...	214	Care.....	229	Rear hatch.....	200
Orientation light	71	Platform lift.....	254	Rear lid	93, 94
Outside temperatur indicator	123	Porsche Active Suspension Management		Rear seat backrests	37
Oxygen sensor	219	(PASM).....	69	Rear spoiler	69
		Sport mode	69	Automatic mode.....	70
P		Porsche Ceramic Composite Brake (PCCB).....	4	Manual control	70
Paint		Porsche Communication Management (PCM)...	98	Rear view mirrors.....	27, 28
Care	224, 227	Porsche Doppelkupplung (PDK)	170	Rear window defogger.....	29, 110
Data.....	285	Drive-Off Assistant.....	169	Rear window heating	110
ParkAssistant	72	Driving in winter	175	Rear window wiper	84
Parking		Faults	171	Recirculating-air button	107
PDK transmission.....	175	Kickdown.....	174	Refuelling	216
Parking aids	72, 73	Launch Control.....	170	Relays	257
Parking brake	57	Manual selection mode	174	Remote control	16
Warning light	58	Reduced driving program.....	176	Readiness.....	17

Replacing battery	266	Sports bucket seat	32	Sport Chrono Plus package	
Standby funktion	17	Sports seat	31	CHRONO stopwatch	136
Synchronization	17	Standard seat	31	Sport mode	64
Replacement key	15	Ventilation	36	Sport mode	68
Replacing bulbs	269	Seat memory		PDK transmission	172
Replacing wiper blades	223	Operating with the remote control	34	Switching on/off	64
Retractable rear spoiler	69	Operation with person buttons	33	Switching PASM on/off	69
Rims		Selector lever position	112, 114	Sport plus mode	64
Diameter	245	Selector lever position indicator,		Sport tires	4
Dimensions	287, 288	PDK transmission	171	Sports bucket seat	32
Rim width	245	Service	133	Sports chassis	298
TPM sensors	241	SET Basic setting on on-board computer	155	Sports exhaust system	57
Roller blind	200	Shift indicator	119	Sports seat	31
Rollover Protection System	56	Shifting gears		Sport-type running gear	298
Roof Transport System	204, 291, 292	Drive-Off Assistant	169	Stability management system	66
Running in	10	Manual transmission	168	Standard seat	31
		Porsche Doppelkupplung (PDK)	170	Starter switch	74
S		Side light, front	277	Starting	75
Safety belts	41	Side marker light	80, 276	Starting engine	77
Cleaning	231	Side vents	109	Steam cleaners	224
Height adjustment	43	Sliding glass roof	200	Steering column	
Tensioner	41	Sliding roof	178	Locking	75
Warning light	42	Snow chains	243	Steering lock	74
Safety compliance sticker	284	Snow tires	242	Steering wheel	
Sealing set	252	Socket	257	Adjustment	37
Seals	229	Spacers	255	Function keys	39
Care	229	Spare key	15	Heating	38
Seat		Speed code letter	244	Lock	75
Adaptive sports seat	31	Speed control	87	Multi functional	39
Adjustment	30	Automatic	86	PDK shift buttons	170
Comfort seat	31	Indicator light	116	Stopping engine	78
Heating	35	Speed limit	129, 244	Stopwatch	136
Memory	33	Speedometer	118	Storage options	91
Position	30	Spoiler	69	Storage possibilities	91

Storing your Porsche	231
Sun visors	40
Suspension management	69

T

Tachometer	119
Tail light	277
Tank	215, 216, 290
Ventilation system	217
Targa	200
Technical data	286
TEL Telephone information	133
Telephone	100
Temperature setting	106, 107
Temperature, outside indicator	123
Test stand, measurements	68
Theft protection	14
Tire	
Care	239
Damage	239
Designations	243
Pressure plate	237
Replacements	240
Traction	238
Wear	238
Tire filling compressor	96
Tire pressure	
Compressor	96
Tire pressure monitoring	
Warning light	151
Wheels	241
Tire pressure monitoring (TPM)	143
Tires	10, 235, 287, 288
Care	235
Checking pressure	250
Dimensions	287, 288
Inscription	244
Loading information	246
New tires	10
Pressure	236, 289
Pressure monitoring	143
Pressure plate	285
Removing and storing	241
Sealant	96, 251, 252
Sidewall	244
Size	244
Snow tires	242
Sport	4
Tool kit	96
Tools	95, 96
Towing	280, 282
Towing hook	280
Towing lug	96
TPM Tire pressure monitoring	143
Track	287, 288
Traction management	63
Transmission	
Drive-Off Assistant	168
Fluid	222, 290
Manual transmission	168
Porsche Doppelkupplung (PDK)	168, 170
Trip Odometer	117
Trunk entrapment	97
Turn signal	
Indicator light	119
Turn signals	82, 119

U

Undercoating	218, 228
--------------------	----------

V

Valves	240
Vanity mirror	40
Vehicle	
Care	224
Dimensions	298
Engine number	285
Identification	284
Identification label	284
Identification number	284
Lifting	254
Load capacity	247
Performance	296
Putting into operation	263
Safety compliance sticker	284
Washing	225
Vehicle identification number	284
Ventilation	106
Vents	106, 109
Viscosity, engine oil	211
Voice control, button	126
Voice control, PCM	126

W

Warning lights and messages	158
Washer	
Fluid	220, 290
Fluid warning light	220
Lever	83
Washing	225

Welcome Home Function	81	Windstop	190
Wheel	10, 235, 287, 288	Installing	190
Alignment	241	Removing	193
Balancing	241	Winter operation	
Bolts	248	Battery	263
Care	235	Coolant	207
Changing	251	Engine oil	208
Checking pressure	250	Jumper cables	267, 268
Inscription	244	Locks	226
Loading information	246	Seals	229
Securing bolts	248	Snow chains	243
Security wheel bolts	15, 96	Tires	242, 287, 288
Sidewall	244	Washer fluid	220
Size	244	Wiper blades	223
Tire pressure	236, 289	Wiper	
Tire pressure plate	285	Blades	223
Tire sealant	251, 252	Lever	83
Wheels		Rear	84
Assembly aids for wheel changes	249	Wiper blades	
Care	229	Care	228
TPM sensors	241	Changing	223
Windows	181, 228		
Anti-crushing protection	26		
Care	228		
Opening/Closing	26		
Washer nozzles	83		
Washer system	83, 220, 290		
Windshield			
Washer nozzles	83		
Wiper blades, changing	223		
Wiper/washer lever	83		
Windshield wipers	83, 223		
Replacing	223		

Free Manuals Download Website

<http://myh66.com>

<http://usermanuals.us>

<http://www.somanuals.com>

<http://www.4manuals.cc>

<http://www.manual-lib.com>

<http://www.404manual.com>

<http://www.luxmanual.com>

<http://aubethermostatmanual.com>

Golf course search by state

<http://golfingnear.com>

Email search by domain

<http://emailbydomain.com>

Auto manuals search

<http://auto.somanuals.com>

TV manuals search

<http://tv.somanuals.com>