



**LG**

Life's Good

# OWNER'S MANUAL

# Blu-ray Disc™/DVD Player

Please read this manual carefully before operating your set and retain it for future reference.

BP125 / BP125N

P/NO : MFL67475811\_1.0

# Safety Information



**CAUTION:** TO REDUCE THE RISK OF ELECTRIC SHOCK DO NOT REMOVE COVER (OR BACK) NO USER-SERVICEABLE PARTS INSIDE REFER SERVICING TO QUALIFIED SERVICE PERSONNEL.



This lightning flash with arrowhead symbol within an equilateral triangle is intended to alert the user to the presence of uninsulated dangerous voltage within the product's enclosure that may be of sufficient magnitude to constitute a risk of electric shock to persons.



The exclamation point within an equilateral triangle is intended to alert the user to the presence of important operating and maintenance (servicing) instructions in the literature accompanying the product.

**WARNING:** TO PREVENT FIRE OR ELECTRIC SHOCK HAZARD, DO NOT EXPOSE THIS PRODUCT TO RAIN OR MOISTURE.

**CAUTION:** The apparatus shall not be exposed to water (dripping or splashing) and no objects filled with liquids, such as vases, shall be placed on the apparatus.

**WARNING:** Do not install this equipment in a confined space such as a book case or similar unit.

**CAUTION:** Do not block any ventilation openings. Install in accordance with the manufacturer's instructions.

Slots and openings in the cabinet are provided for ventilation and to ensure reliable operation of the product and to protect it from over heating. The openings shall be never be blocked by placing the product on a bed, sofa, rug or other similar surface. This product shall not be placed in a built-in installation such as a bookcase or rack unless proper ventilation is provided or the manufacturer's instruction has been adhered to.



Use of controls, adjustments or the performance of procedures other than those specified herein may result in hazardous radiation exposure.

## CAUTION concerning the Power Cord

Most appliances recommend they be placed upon a dedicated circuit;

That is, a single outlet circuit which powers only that appliance and has no additional outlets or branch circuits. Check the specification page of this owner's manual to be certain. Do not overload wall outlets. Overloaded wall outlets, loose or damaged wall outlets, extension cords, frayed power cords, or damaged or cracked wire insulation are dangerous. Any of these conditions could result in electric shock or fire. Periodically examine the cord of your appliance, and if its appearance indicates damage or deterioration, unplug it, discontinue use of the appliance, and have the cord replaced with an exact replacement part by an authorized service centre. Protect the power cord from physical or mechanical abuse, such as being twisted, kinked, pinched, closed in a door, or walked upon. Pay particular attention to plugs, wall outlets, and the point where the cord exits the appliance. To disconnect power from the mains, pull out the mains cord plug. When installing the product, ensure that the plug is easily accessible.

**NOTICE:** For safety marking information including product identification and supply ratings, please refer to the main label on the bottom or rear of the apparatus.

**CAUTION:** Only use the AC adapter supplied with this device. Do not use a power supply from another device or another manufacturer. Using any other power cable or power supply may cause damage to the device and void your warranty.

This device is equipped with a portable battery or accumulator.

**Safety way to remove the battery or the battery from the equipment:** Remove the old battery or battery pack, follow the steps in reverse order than the assembly. To prevent contamination of the environment and bring on possible threat to human and animal health, the old battery or the battery put it in the appropriate container at designated collection points. Do not dispose of batteries or battery together with other waste. It is recommended that you use local, free reimbursement systems batteries and accumulators. The battery shall not be exposed to excessive heat such as sunshine, fire or the like.

### Disposal of your old appliance



1. When this crossed-out wheeled bin symbol is attached to a product it means the product is covered by the European Directive 2002/96/EC.
2. All electrical and electronic products shall be disposed of separately from the municipal waste stream via designated collection facilities appointed by the government or the local authorities.
3. The correct disposal of your old appliance will help prevent potential negative consequences for the environment and human health.
4. For more detailed information about disposal of your old appliance, please contact your city office, waste disposal service or the shop where you purchased the product.

### Disposal of waste batteries/accumulators



1. When this crossed-out wheeled bin symbol is attached to batteries/accumulators of Your product it means they are covered by European Directive 2006/66/EC.
2. This symbol may be combined with chemical symbols for mercury(Hg), cadmium(Cd) or lead(Pb) if the battery Contains more that 0.0005% of mercury, 0.002% of cadmium or 0.004% of lead.
3. All batteries/accumulators should be disposed separately from the municipal waste stream via designated collection facilities appointed by the government or the local authorities.
4. The correct disposal of Your old batteries/ accumulators will help to prevent potential negative consequences for the environment, animal and human health.
5. For more detailed information about disposal of Your old batteries/accumulators, please contact Your city office, waste disposal service or the shop where You purchased the product.



LG Electronics hereby declares that this/these product(s) is/are in compliance with the essential requirements and other relevant provisions of Directive 2004/108/EC, 2006/95/EC and 2009/125/EC.

**European Standards Centre:**

Krijgsman 1, 1186 DM Amstelveen, The Netherlands

- Please note that this is NOT a Customer Service contact point. For Customer Service Information, see Warranty Card or contact the dealer that you purchased this product.

**Notes on Copyrights**

- Because AACS (Advanced Access Content System) is approved as content protection system for Blu-ray Disc format, similar to use of CSS (Content Scramble System) for DVD format, certain restrictions are imposed on playback, analog signal output, etc., of AACS protected contents. The operation of this product and restrictions on this product may vary depending on your time of purchase as those restrictions may be adopted and/or changed by AACS after the production of this product.
- Furthermore, BD-ROM Mark and BD+ are additionally used as content protection systems for Blu-ray Disc format, which imposes certain restrictions including playback restrictions for BD-ROM Mark and/or BD+ protected contents. To obtain additional information on AACS, BD-ROM Mark, BD+, or this product, please contact an authorized Customer Service Centre.
- Many BD-ROM/DVD discs are encoded with copy protection. Because of this, you should only connect your player directly to your TV, not to a VCR. Connecting to a VCR results in a distorted picture from copy-protected discs.
- This product incorporates copyright protection technology that is protected by U.S. patents and other intellectual property rights. Use of this copyright protection technology must be authorized by Rovi Corporation, and is intended for home and other limited viewing uses only unless otherwise authorized by Rovi Corporation. Reverse engineering or disassembly is prohibited.
- Under the U.S. Copyright laws and Copyright laws of other countries, unauthorized recording, use, display, distribution, or revision of television programs, videotapes, BD-ROM discs, DVDs, CDs and other materials may subject you to civil and/or criminal liability.

## Important Notice for TV colour system

The colour system of this player differs according to currently playing discs.

For example, when the player plays the disc recorded in the NTSC colour system, the image is output as an NTSC signal.

Only the multi system colour TV can receive all signals output from the player.

- If you have a PAL colour system TV, you will see just distorted images when using discs or video contents recorded in NTSC.
- The multi system colour TV changes the colour system automatically according to input signals. In case that the colour system is not changed automatically, turn it off and then on to see normal images on screen.
- Even if the disc recorded in NTSC colour system are well displayed on your TV, these may not be recorded correctly on your recorder.

# Table of Contents

## 1 Getting Started

---

- 2 Safety Information
- 8 Introduction
  - 8 – Playable Discs and symbols used in this manual
  - 9 – About the “” Symbol Display
  - 9 – Compatibility Notes
  - 10 – File requirement
  - 11 – AVCHD (Advanced Video Codec High Definition)
  - 12 – Certain System Requirements
  - 12 – Regional Code
  - 12 – System Select
- 13 Remote control
- 14 Front panel
- 14 Rear panel

## 2 Connecting

---

- 15 Connecting the AC Adapter
- 15 Connecting to Your TV
  - 16 – What is SIMPLINK?
  - 17 – Resolution Setting
- 18 Connecting to an Amplifier
  - 18 – Connecting to an Amplifier via HDMI Output
  - 19 – Connecting to an Amplifier via Digital Audio Output
- 20 USB device connection
  - 20 – Playback content in the USB device

## 3 System Setting

---

- 21 Settings
  - 21 – Initial Setup
  - 21 – Adjust the Setup Settings
- 22 – [DISPLAY] Menu
- 23 – [LANGUAGE] Menu
- 24 – [AUDIO] Menu
- 25 – [LOCK] Menu
- 26 – [OTHERS] Menu

## 4 Operating

---

- 27 General Playback
  - 27 – Using [HOME] menu
  - 27 – Playing a Disc
  - 27 – Playing a file on disc/USB device
- 28 – Basic operations for video and audio content
  - 28 – Basic operations for photo content
  - 28 – Using the disc menu
  - 29 – Resume playback
  - 29 – Last Scene Memory
- 29 Advanced Playback
  - 29 – Repeat Playback
  - 30 – Repeating a specific portion
  - 30 – Viewing content information
  - 30 – Changing content list view
  - 31 – Selecting a subtitle file
  - 31 – Options while viewing a photo
  - 32 – Listening to music while slide show
- 32 On-Screen display
  - 32 – Displaying content information on-screen
    - 33 – Playing from selected time
    - 33 – Selecting a subtitle language
    - 34 – Hearing a different audio
    - 34 – Watching from a different angle
    - 34 – Changing the TV Aspect Ratio
    - 35 – Changing subtitle code page
    - 35 – Changing the Picture Mode

## 5 Troubleshooting

---

- 36 Troubleshooting
- 36 – General
- 37 – Picture
- 37 – Customer Support
- 37 – Open source software notice

## 6 Appendix

---

- 38 Controlling a TV with the Supplied Remote Control
- 38 – Setting up the remote to control your TV
- 39 Area Code List
- 40 Language code List
- 41 Trademarks and Licenses
- 43 Audio Output Specifications
- 45 Specifications
- 46 Maintenance
- 46 – Handling the Unit
- 46 – Notes on Discs

1

2

3

4











5

6

# Introduction

1

## Playable Discs and symbols used in this manual

Media/Term	Logo	Symbol	Description
Blu-ray		<b>BD</b>	<ul style="list-style-type: none"> <li>Discs such as movies that can be purchased or rented.</li> <li>BD-R/RE discs that are recorded in BDAV format.</li> </ul>
		<b>MOVIE</b> <b>MUSIC</b> <b>PHOTO</b>	<ul style="list-style-type: none"> <li>BD-R/RE discs that contain Movie, Music or Photo files.</li> <li>ISO 9660+JOLIET, UDF and UDF Bridge format</li> </ul>
DVD-ROM DVD-R DVD-RW DVD+R DVD+RW (8 cm, 12 cm)	    	<b>DVD</b>	<ul style="list-style-type: none"> <li>Discs such as movies that can be purchased or rented.</li> <li>Movie mode and finalized only</li> <li>Supports the dual layer disc also</li> </ul>
		<b>AVCHD</b>	Finalized AVCHD format
		<b>MOVIE</b> <b>MUSIC</b> <b>PHOTO</b>	<ul style="list-style-type: none"> <li>DVD±R/RW discs that contain Movie, Music or Photo files.</li> <li>ISO 9660+JOLIET, UDF and UDF Bridge format</li> </ul>
DVD-RW (VR) (8 cm, 12 cm)		<b>DVD</b>	VR mode and finalized only
Audio CD (8 cm, 12 cm)		<b>ACD</b>	Audio CD
CD-R/RW (8 cm, 12 cm)		<b>MOVIE</b> <b>MUSIC</b> <b>PHOTO</b>	<ul style="list-style-type: none"> <li>CD-R/RW discs that contain Movie, Music or Photo files.</li> <li>ISO 9660+JOLIET, UDF and UDF Bridge format</li> </ul>
Note	-		Indicates special notes and operating features.
Caution	-		Indicates cautions for preventing possible damages from abuse.



### ! Note

- Depending on the conditions of the recording equipment or the CD-R/RW (or DVD±R/RW) disc itself, some CD-R/RW (or DVD±R/RW) discs cannot be played on the unit.
- Depending on the recording software & the finalization, some recorded discs (CD-R/RW, DVD±R/RW, BD-R/RE) may not be playable.
- BD-R/RE, DVD±R/RW and CD-R/RW discs recorded using a personal computer or a DVD or CD Recorder may not play if the disc is damaged or dirty, or if there is dirt or condensation on the player's lens.
- If you record a disc using a personal computer, even if it is recorded in a compatible format, there are cases in which it may not play because of the settings of the application software used to create the disc. (Check with the software publisher for more detailed information.)
- This player requires discs and recordings to meet certain technical standards in order to achieve optimal playback quality.
- Pre-recorded DVDs are automatically set to these standards. There are many different types of recordable disc formats (including CD-R containing MP3 or WMA files) and these require certain pre-existing conditions to ensure compatible playback.
- Customers should note that permission is required in order to download MP3 / WMA files and music from the Internet. Our company has no right to grant such permission. Permission should always be sought from the copyright owner.
- You have to set the disc format option to [Mastered] in order to make the discs compatible with the LG players when formatting rewritable discs. When setting the option to Live System, you cannot use it on LG player. (Mastered/Live File System : Disc format system for windows Vista)

## About the "⓪" Symbol Display

"⓪" may appear on your TV display during operation and indicates that the function explained in this owner's manual is not available on that specific media.

## Compatibility Notes

- Because BD-ROM is a new format, certain disc, digital connection and other compatibility issues are possible. If you experience compatibility problems, please contact an authorized Customer Service Center.
- This unit allows you to enjoy functions such as picture-in-picture, secondary audio and Virtual packages, etc., with BD-ROM supporting BONUSVIEW (BD-ROM version 2 Profile 1 version 1.1). Secondary video and audio can be played from a disc compatible with the picture-in-picture function. For the playback method, refer to the instructions in the disc.
- Viewing high-definition content and up-converting standard DVD content may require a HDMI-capable input or HDCP-capable DVI input on your display device.
- Some BD-ROM and DVD discs may restrict the use of some operation commands or features.
- Dolby TrueHD, Dolby Digital Plus and DTS-HD are supported with maximum 7.1 channels if you use HDMI connection for the audio output of the unit.
- You can use a USB device to store some disc related information. The disc you are using will control how long this information is retained.

## File requirement

### Movie files

File Location	File Extension	Codec Format	Audio Format	Subtitle
Disc, USB	".avi", ".divx", ".mpg", ".mpeg", ".mkv", ".mp4", ".asf", ".wmv", ".m4v" (DRM free), ".vob", ".3gp", ".flv"	DIVX3.xx, DIVX4.xx, DIVX5.xx, DIVX6.xx (standard playback only), XVID, MPEG1 SS, H.264/MPEG-4 AVC, MPEG2 PS, MPEG2 TS, VC-1 SM (WMV3)	Dolby Digital, DTS, MP3, AAC, AC3, WMA	SubRip (.srt / .txt), SAMI (.smi), SubStation Alpha (.ssa/.txt), MicroDVD (.sub/.txt), VobSub (.sub), SubViewer 1.0 (.sub), SubViewer 2.0 (.sub/.txt), TMPlayer (.txt), DVD Subtitle System (.txt)

### Music files

File Location	File Extension	Sampling Frequency	Bitrate	Note
Disc, USB	".mp3", ".wav", ".wma", ".m4a" (DRM free), ".flac"	within 32 - 48 kHz (WMA), within 16 - 48 kHz (MP3)	within 32 - 192 kbps (WMA), within 32 - 320 kbps (MP3)	Some wav files are not supported on this player.

### Photo files

File Location	File Extension	Recommended Size	Note
Disc, USB	".jpg", ".jpeg", ".png", ".gif"	Less than 4,000 x 3,000 x 24 bit/pixel Less than 3,000 x 3,000 x 32 bit/pixel	Progressive and lossless compression photo image files are not supported.

**! Note**

- The file name is limited to 180 characters.
- Maximum files/Folder: Less than 2000 (total number of files and folders)
- Depending on the size and number of the files, it may take several minutes to read the contents on the media.
- The file requirements on page 10 are not always compatible. There may have some restrictions by file features.
- This unit cannot support the ID3 Tag embedded MP3 file.
- The total playback time of audio file indicated on the screen may not correct for VBR files.
- HD movie files contained on the CD or USB 1.0/1.1 may not played properly. Blu-ray Disc, DVD or USB 2.0 are recommended to play back HD movie files.
- This player supports H.264/MPEG-4 AVC profile Main, High at Level 4.1. For a file with higher level, the warning message will appear on the screen.
- This player does not support files that are recorded with GMC\*<sup>1</sup> or Qpel\*<sup>2</sup>.
  - \*1 GMC – Global Motion Compensation
  - \*2 Qpel – Quarter pixel

**! Note**

- A “avi” file which is encoded “WMV 9 codec” is not supported.
- This player supports UTF-8 files even it contains Unicode subtitle contents. This player can not support the pure Unicode subtitle files.
- Depending on the types of file or ways of recording, it may not play back.
- A disc which was recorded by multi-session on normal PC is not supported on this player.
- To be playback a movie file, movie file name and Subtitle file name must be the same.
- If video codec is MPEG2 TS or MPEG2 PS, subtitle does not play back.

## AVCHD (Advanced Video Codec High Definition)

- This player can playback AVCHD format discs. These discs are normally recorded and used in camcorders.
- The AVCHD format is a high definition digital video camera format.
- The MPEG-4 AVC/H.264 format is capable of compressing images at higher efficiency than that of the conventional image compressing format.
- This player can playback AVCHD discs using “x.v.Colour” format.
- Some AVCHD format discs may not play depending on the recording condition.
- AVCHD format discs need to be finalized.
- “x.v.Colour” offers a wider colour range than normal DVD camcorder discs.

## Certain System Requirements

For high definition video playback:

- High definition display that has HDMI input jack.
- BD-ROM disc with high definition content.
- HDMI or HDCP capable DVI input on your display device is required for some content (as specified by disc authors).

For Dolby® Digital Plus, Dolby TrueHD and DTS-HD multi-channel audio playback:

- An amplifier/receiver with a built-in (Dolby Digital, Dolby Digital Plus, Dolby TrueHD, DTS or DTS-HD) decoder.
- Main, center, surround speakers and subwoofer as necessary for chosen format.

## Regional Code

This unit has a regional code printed on the rear of the unit. This unit can play only BD-ROM or DVD discs labelled same as the rear of the unit or "ALL".

## System Select

Open the disc tray using the ▲ (OPEN/CLOSE) button and then, press and hold ■ (PAUSE) for more than five seconds to change the color system (PAL /NTSC /AUTO).

## Remote control

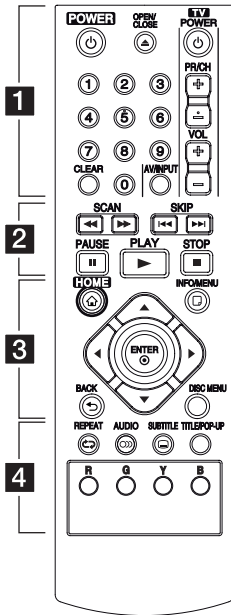

### Battery Installation

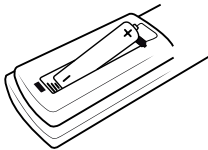

Remove the battery cover on the rear of the Remote Control, and insert the R03 (size AAA) battery with **+** and **-** matched correctly.

..... **1** .....

**POWER** (⏻): Switches the player ON or OFF.

**▲ (OPEN/CLOSE)**: Opens and closes the disc tray.

**0-9 numerical buttons**: Selects numbered options in a menu.

**CLEAR**: Removes a number when setting the password.

**TV Control Buttons**: See page 38.

..... **2** .....

**◀◀/▶▶ (SCAN)**: Searches backward or forward.

**◀◀◀/▶▶▶ (SKIP)**: Goes to the next or previous chapter / track / file.

**⏸ (PAUSE)**: Pauses playback.

**▶ (PLAY)**: Starts playback.

**■ (STOP)**: Stops playback.

..... **3** .....

**HOME** (🏠): Displays or exits the [Home Menu].

**INFO/MENU** (ℹ): Displays or exits On-Screen Display.

**Direction buttons**: Selects an option in the menu.

**ENTER** (⊙): Acknowledges menu selection.

**BACK** (↶): Exits the menu or resumes playback. The resume play function may not work depending on the BD-ROM disc.

**DISC MENU**: Accesses menu on a disc.

..... **4** .....

**REPEAT** (↺): Repeats a desired section or sequence.

**AUDIO** (🔊): Selects an audio language.

**SUBTITLE** (🗨): Selects a subtitle language.

**TITLE/POP-UP**: Displays the DVD title menu or BD-ROM's pop-up menu, if available.

**Colored (R, G, Y, B) buttons**: Use to navigate BD-ROM menus. They are also used for [MOVIE], [PHOTO] and [MUSIC] menu.

## Front panel

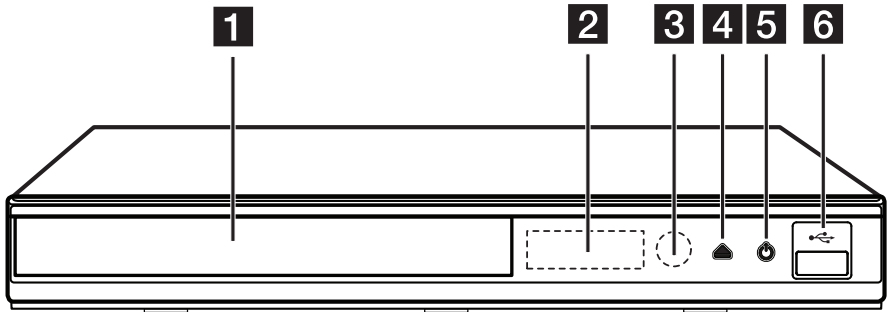

- 1** Disc Tray
- 2** Power indicator
- 3** Remote Sensor
- 4** ▲ (OPEN / CLOSE)
- 5** ⏻ (POWER)
- 6** USB Port

## Rear panel

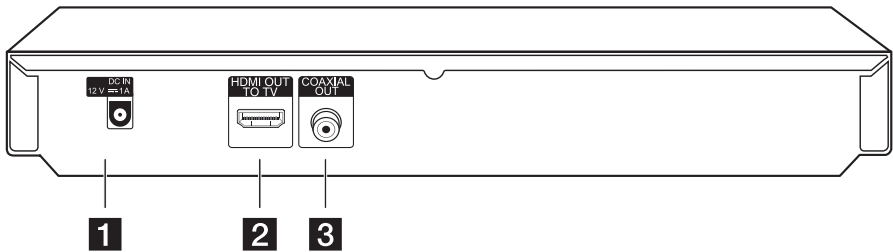

- 1** DC IN 12V (AC adapter input)
- 2** HDMI OUT
- 3** DIGITAL AUDIO OUT (COAXIAL)

## Connecting the AC Adapter

Connect the unit to the power supply with the supplied AC Adapter.

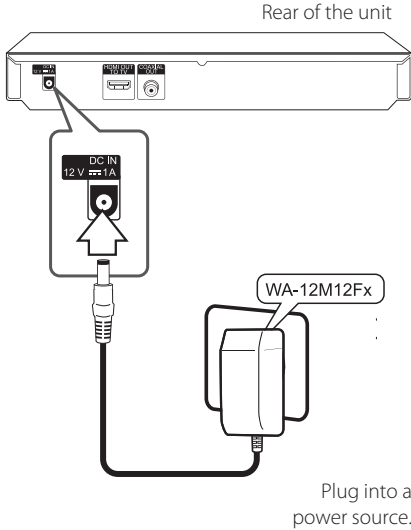

- Contact an electrical parts distributor for assistance in selecting a suitable AC plug adapter or AC cord set.
- This AC adapter is manufactured by APD Group Yang Ming Industrial.

### ⚠ Caution

Only use the AC adapter supplied with this device. Do not use a power supply from another device or manufacturer. Using any other power cable or power supply may cause damage to the device and void your warranty.

## Connecting to Your TV

If you have a HDMI TV or monitor, you can connect it to this player using a HDMI cable (Type A, High Speed HDMI™ Cable). Connect the HDMI jack on the player to the HDMI jack on a HDMI compatible TV or monitor.

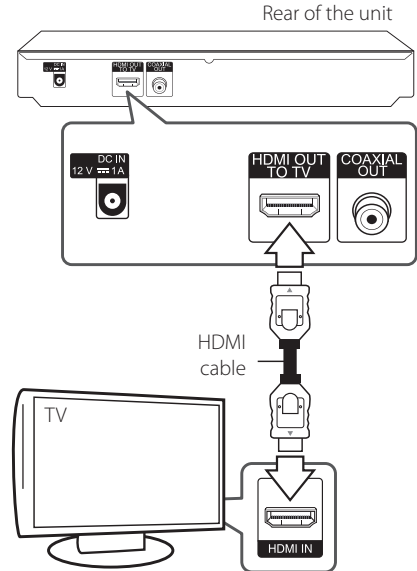

Set the TV's source to HDMI (refer to TV's Owner's manual).

### ! Note

Please refer to the manuals of your TV, Stereo System or other devices as necessary to make the best connections.

## Additional Information for HDMI

- When you connect a HDMI or DVI compatible device make sure of the following:
  - Try switching off the HDMI/DVI device and this player. Next, switch on the HDMI/DVI device and leave it for around 30 seconds, then switch on this player.
  - The connected device's video input is set correctly for this unit.
  - The connected device is compatible with 720x576p, 1280x720p, 1920x1080i or 1920x1080p video input.
- Not all HDCP-compatible HDMI or DVI devices will work with this player.
  - The picture will not be displayed properly with non-HDCP device.

### ! Note

- If a connected HDMI device does not accept the audio output of the player, the HDMI device's audio sound may be distorted or may not output.
- When you use HDMI connection, you can change the resolution for the HDMI output. (Refer to "Resolution Setting" on page 17)
- Select the type of video output from the HDMI OUT jack using [HDMI Color Setting] option on the [Setup] menu (see page 23).
- Changing the resolution when the connection has already been established may result in malfunctions. To solve the problem, turn off the player and then turn it on again.
- When the HDMI connection with HDCP is not verified, TV screen is changed to black screen. In this case, check the HDMI connection, or disconnect the HDMI cable.
- If there are noises or lines on the screen, please check the HDMI cable (length is generally limited to 4.5 m).

## What is SIMPLINK?



Some functions of this unit are controlled by the TV's remote control when this unit and LG TV's with SIMPLINK are connected through HDMI connection.

Controllable functions by LG TV's remote control; Play, Pause, Scan, Skip, Stop, Power Off, etc.

Refer to the TV owner's manual for the details of SIMPLINK function.

LG TV's with SIMPLINK function has the logo as shown above.

### ! Note

Depending on the disc type or playing status, some SIMPLINK operation may differ from your purpose or not work.



## Resolution Setting

The player provides several output resolutions for HDMI OUT jack. You can change the resolution using [Setup] menu.

1. Press HOME (🏠).
2. Use ◀/▶ to select the [Setup] and press ENTER (⊙). The [Setup] menu appears.
3. Use ▲/▼ to select [DISPLAY] option then press ▶ to move to the second level.
4. Use ▲/▼ to select the [Resolution] option then press ENTER (⊙) to move to the third level.



5. Use ▲/▼ to select the desired resolution then press ENTER (⊙) to confirm your selection.



### ! Note

- If your TV does not accept the resolution you have set on the player, you can set resolution to 576p as follows:
  1. Press ▲ to open the disc tray.
  2. Press ■ (STOP) for more than 5 seconds.
- When you set the resolution to 576i with HDMI connection, actual resolution is outputted to 576p.
- If you select a resolution manually and then connect the HDMI jack to TV and your TV does not accept it, the resolution setting is set to [Auto].
- If you select a resolution that your TV does not accept, the warning message will appear. After resolution change, if you cannot see the screen, please wait 20 seconds and the resolution will automatically revert back to the previous resolution.
- The 1080p video output frame rate may be automatically set to either 24 Hz or 50 Hz depending both on the capability and preference of the connected TV and based on the native video frame rate of the content on the BD-ROM disc.

## Connecting to an Amplifier

Make one of the following connections, depending on the capabilities of your existing equipment.

- HDMI Audio connection (page 18)
- Digital Audio connection (page 19)

Since many factors affect the type of audio output, see "Audio Output Specifications" for details (pages 43).

### About Digital Multi-channel sound

A digital multi-channel connection provides the best sound quality. For this, you need a multi-channel Audio/Video Receiver that supports one or more of the audio formats supported by your player. Check the logos on the front of the Audio/Video receiver and the manual. (PCM Stereo, PCM Multi-Ch, Dolby Digital, Dolby Digital Plus, Dolby TrueHD, DTS and/or DTS-HD)

## Connecting to an Amplifier via HDMI Output

Connect the player's HDMI OUT jack to the corresponding in jack on your amplifier using a HDMI cable.

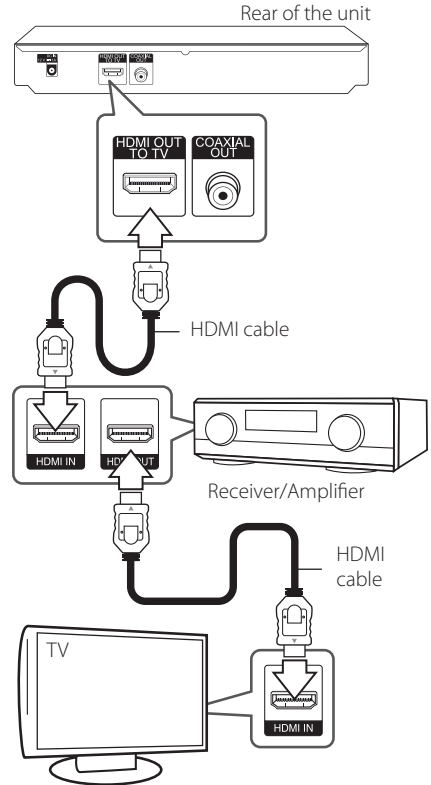

Connect the amplifier's HDMI output jack to HDMI input jack on your TV using a HDMI cable if your amplifier has HDMI output jack.

You will need to activate the player's digital output. (See "[AUDIO] Menu" on pages 24)

## Connecting to an Amplifier via Digital Audio Output

Connect the player's COAXIAL OUT jack to the corresponding in jack on your amplifier using an optional digital audio cable.

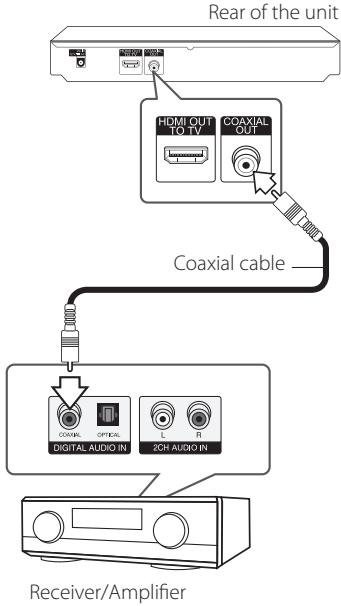

You will need to activate the player's digital output.  
(See "[AUDIO] Menu" on pages 24.)

## USB device connection

This player can play movie, music and photo files contained in the USB device.

### Playback content in the USB device

1. Insert a USB device to the USB port until it fits into place.

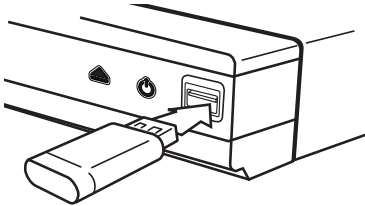

When you connect the USB device on the HOME menu, the player plays a music file contained in the USB storage device automatically. If the USB storage device is containing various types of files, a menu for the file type selection will appear.

File loading may takes few minutes depending on the number of content stored in the USB storage device. Press ENTER (⊙) while [Cancel] is selected to stop loading.

2. Press HOME (🏠).
3. Select [Movie], [Photo] or [Music] using ◀/▶, and press ENTER (⊙).
4. Select the [USB] option using ▲/▼, and press ENTER (⊙).

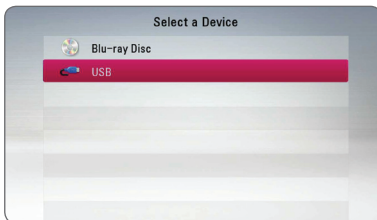

5. Select a file using ▲/▼/◀/▶, and press PLAY or ENTER (⊙) to play the file.
6. Withdraw the USB device carefully.

### Note

- This player supports USB flash drive/ external HDD formatted in FAT32 and NTFS when accessing files (music, photo, movie). However, for Blu-ray contents, only FAT32 format is supported. Use the USB flash drive/ external HDD formatted in either FAT32 or NTFS when enjoying Blu-ray contents.
- This unit can support up to 4 partitions of the USB device.
- Do not extract the USB device during operation (play, etc.).
- A USB device which requires additional program installation when you have connected it to a computer, is not supported.
- USB device: USB device that supports USB1.1 and USB2.0.
- Movie, music and photo files can be played. For details of operations on each file, refer to relevant pages.
- Regular back up is recommended to prevent data loss.
- If you use a USB extension cable, USB HUB or USB Multi-reader, the USB device may not be recognized.
- Some USB device may not work with this unit.
- Digital camera and mobile phone are not supported.
- USB Port of the unit cannot be connected to PC. The unit cannot be used as a storage device.

# Settings

## Initial Setup

When you turn on the unit for the first time, the initial setup wizard appears on the screen. Set the display language on the initial setup wizard.

1. Press **⏻** (POWER).

The initial setup wizard appears on the screen.

2. Use **▲/▼/◀/▶** to select a display language and press **ENTER** (⊙).



3. Check the setting that you have set in the previous step.

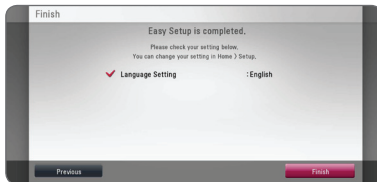

Press **ENTER** (⊙) while [Finish] is highlighted to finish the initial setup settings. If there is any settings to be changed, use **◀/▶** to select [Previous] and press **ENTER** (⊙).

## Adjust the Setup Settings

You can change the settings of the player in the [Setup] menu.

1. Press **HOME** (🏠).

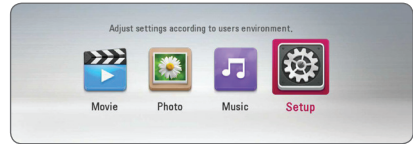

2. Use **◀/▶** to select the [Setup] and press **ENTER** (⊙). The [Setup] menu appears.

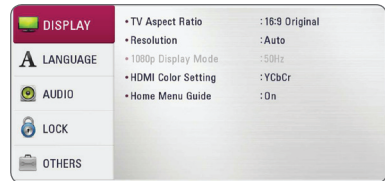

3. Use **▲/▼** to select the first setup option, and press **▶** to move to the second level.



4. Use **▲/▼** to select a second setup option, and press **ENTER** (⊙) to move to the third level.



5. Use **▲/▼** to select a desired setting, and press **ENTER** (⊙) to confirm your selection.

## [DISPLAY] Menu

### TV Aspect Ratio

Select a TV aspect ratio option according to your TV type.

#### [4:3 Letter Box]

Select when a standard 4:3 TV is connected. Displays theatrical images with masking bars above and below the picture.

#### [4:3 Pan Scan]

Select when a standard 4:3 TV is connected. Displays pictures cropped to fill your TV screen. Both sides of the picture are cut off.

#### [16:9 Original]

Select when a 16:9 wide TV is connected. The 4:3 picture is displayed with an original 4:3 aspect ratio, with black bars appearing at the left and right sides.

#### [16:9 Full]

Select when a 16:9 wide TV is connected. The 4:3 picture is adjusted horizontally (in a linear proportion) to fill the entire screen.

#### Note

You cannot select [4:3 Letter Box] and [4:3 Pan Scan] option when the resolution is set to higher than 720p.

### Resolution

Sets the output resolution of the HDMI video signal. Refer to page 17 for details about the resolution setting.

#### [Auto]

If the HDMI OUT jack is connected to TVs providing display information (EDID), automatically selects the resolution best suited to the connected TV.

#### [1080p]

Outputs 1080 lines of progressive video.

#### [1080i]

Outputs 1080 lines of interlaced video.

#### [720p]

Outputs 720 lines of progressive video.

#### [576p]

Outputs 576 lines of progressive video.

#### [576i]

Outputs 576 lines of interlaced video.

### 1080p Display Mode

When the resolution is set to 1080p, select [24 Hz] for smooth presentation of film material (1080p/24 Hz) with a HDMI-equipped display compatible with 1080p/24 Hz input.

#### Note

- When you select [24 Hz], you may experience some picture disturbance when the video switches video and film material. In this case, select [50 Hz].
- Even when [1080p Display Mode] is set to [24 Hz], if your TV is not compatible with 1080p/24 Hz, the actual frame frequency of the video output will be 50 Hz to match the video source format.

## HDMI Color Setting

Select the type of output from the HDMI OUT jack. For this setting, please refer to the manuals of your display device.

---

### [YCbCr]

Select when connecting to a HDMI display device.

---

### [RGB]

Select when connecting to a DVI display device.

---

## Home Menu Guide

This function allows you to display or delete the guide bubble on the Home Menu. Set this option to [On] for displaying guide.

## [LANGUAGE] Menu

### Display Menu

Select a language for the [Setup] menu and on-screen display.

### Disc Menu/Disc Audio/ Disc Subtitle

Select the language you prefer for the audio track (disc audio), subtitles, and the disc menu.

---

#### [Original]

Refers to the original language in which the disc was recorded.

---

#### [Other]

Press ENTER (⏻) to select another language. Use number buttons then press ENTER (⏻) to enter the corresponding 4-digit number according to the language code list on page 40.

---

#### [Off] (Disc Subtitle only)

Turn off Subtitle.

---

#### ! Note

Depending on the disc, your language setting may not work.

## [AUDIO] Menu

Each disc has a variety of audio output options. Set the player's Audio options according to the type of audio system you use.

### ! Note

Since many factors affect the type of audio output, see "Audio Output Specifications" on page 43 for details.

## Digital Output

### [PCM Stereo] (HDMI, COAXIAL)

Select if you connect this unit's HDMI OUT or COAXIAL OUT jack to a device with two-channel digital stereo decoder.

### [PCM Multi-Ch] (HDMI only)

Select if you connect this unit's HDMI OUT jack to a device with multi-channel digital decoder.

### [DTS Re-Encode] (HDMI, COAXIAL)

Select if you connect this unit's HDMI OUT or COAXIAL OUT jack to a device with DTS decoder.

### [BitStream] (HDMI, COAXIAL)

Select if you connect this unit's COAXIAL OUT and HDMI OUT jack to a device with LPCM, Dolby Digital, Dolby Digital Plus, Dolby TrueHD, DTS and DTS-HD decoder.

### ! Note

- When [Digital Output] option is set to [PCM Multi-Ch], the audio may output as PCM Stereo if the PCM Multi-Ch information is not detected from HDMI device with EDID.
- If the [Digital Output] option is set to [DTS Re-Encode], the DTS Re-Encode audio is outputted for BD-ROM discs with secondary audio and the original audio is outputted for the other discs (like [BitStream]).

## Sampling Freq. (Digital Audio Output)

### [48 kHz]

Select this if your A/V Receiver or Amplifier is not capable of handling 192 kHz and 96 kHz signal. When this choice is made, this unit automatically converts any 192 kHz and 96 kHz signals to 48 kHz so your system can decode them.

### [96 kHz]

Select this if your A/V Receiver or Amplifier is not capable of handling 192 kHz signals. When this choice is made, this unit automatically converts any 192 kHz signals to 96 kHz so your system can decode them.

### [192 kHz]

Select this if your A/V Receiver or Amplifier is capable of handling 192 kHz signals.

Check the documentation for your A/V Receiver or Amplifier to verify its capabilities.

## DRC (Dynamic Range Control)

This function allows you to listen to a movie at a lower volume without losing clarity of sound.

### [Auto]

The dynamic range of the Dolby TrueHD audio output is specified by itself. And the dynamic range of the Dolby Digital and Dolby Digital Plus are operated as same as the [On] mode.

### [On]

Compress the dynamic range of the Dolby Digital, Dolby Digital Plus or Dolby TrueHD audio output.

### [Off]

Turns off this function.

### ! Note

The DRC setting can be changed only when a disc is not inserted or the unit is in complete stop mode.



## [LOCK] Menu

The [LOCK] settings affect only BD-ROM and DVD playback.

To access the any features in [LOCK] settings, you must enter the 4-digit security code you have created.

If you have not entered a password yet, you are prompted to do so. Enter a 4-digit password twice, and press ENTER (Ⓞ) to create a new password.

### Password

You can create or change the password.

#### [None]

Enter a 4-digit password twice, and press ENTER (Ⓞ) to create a new password.

#### [Change]

Enter the current password and press ENTER (Ⓞ). Enter a 4-digit password twice, and press ENTER (Ⓞ) to create a new password.

### If you forget your password

If you forget your password, you can clear it using the following steps:

1. Remove any disc that might be in the player.
2. Select [Password] option in the [Setup] menu.
3. Use Number buttons to enter "210499". The password is cleared.

#### ! Note

If you make a mistake before pressing ENTER (Ⓞ), press CLEAR. Then input the correct password.

## DVD Rating

Blocks playback of rated DVD based on their content. (Not all discs are rated.)

#### [Unlock]

If you select [Unlock], parental control is not active and the disc plays in full.

#### [Rating 1-8]

Rating one (1) has the most restrictions and rating eight (8) is the least restrictive.

## Blu-ray Disc Rating

Set an age limit of BD-ROM play. Use number buttons to input an age limit for BD-ROM viewing.

#### [255]

All BD-ROM can be played.

#### [0-254]

Prohibits play of BD-ROM with corresponding ratings recorded on them.

#### ! Note

The [Blu-ray Disc Rating] will be applied only for the Blu-ray disc that containing the Advanced Rating Control.

## Area Code

Enter the code of the area whose standards were used to rate the DVD video disc, based on the list on page 39.

## [OTHERS] Menu

### DivX® VOD

ABOUT DIVX VIDEO: DivX® is a digital video format created by DivX, LLC, a subsidiary of Rovi Corporation. This is an official DivX Certified® device that plays DivX video. Visit [divx.com](http://divx.com) for more information and software tools to convert your files into DivX videos.

ABOUT DIVX VIDEO-ON-DEMAND: This DivX Certified® device must be registered in order to play purchased DivX Video-on-Demand (VOD) movies. To obtain your registration code, locate the DivX VOD section in your device setup menu. Go to [vod.divx.com](http://vod.divx.com) for more information on how to complete your registration.

---

#### [Register]

Displays the registration code of your player.

---

#### [Deregister]

Deactivate your player and display the deactivation code.



#### Note

All the downloaded videos from DivX(R) VOD with this player's registration code can only be played on this unit.

### Auto Power Off

The screen saver appears when you leave the player in Stop mode for about five minutes. If you set this option to [On], the unit automatically turns off within 20 minutes since the Screen Saver is displayed. Set this option to [Off] to leave the screen saver until the unit is operated by the user.

### Initialize

---

#### [Factory Set]

You can reset the player to its original factory settings.

---

#### [Blu-ray Storage Clear]

Initializes the Blu-ray contents from the connected USB storage.

### Software

---

#### [Information]

Displays the current software version.

---

## General Playback

### Using [HOME] menu

The home menu appears when you press HOME (🏠). Use ◀/▶ to select a category and press ENTER (⊙).



<b>1</b>	<b>[Movie]</b> - Plays video contents.
<b>2</b>	<b>[Photo]</b> - Plays photo contents.
<b>3</b>	<b>[Music]</b> - Plays audio contents.
<b>4</b>	<b>[Setup]</b> - Adjusts the system settings.

### Playing a Disc

#### BD DVD ACD AVCHD

1. Press ▲ (OPEN/CLOSE), and place a disc on the disc tray.
2. Press ▲ (OPEN/CLOSE) to close the disc tray.  
For the most Audio CD, BD-ROM and DVD-ROM discs, playback starts automatically.
3. Press HOME (🏠).
4. Select [Movie] or [Music] using ◀/▶, and press ENTER (⊙).
5. Select [Blu-ray Disc], [DVD], [VR] or [Audio] option using ▲/▼, and press ENTER (⊙).

#### ! Note

- Playback functions described in this manual are not always available in every files and media. Some functions can be restricted depending on many factors.
- Depending on the BD-ROM titles, a USB device connection may be needed for the proper playback.
- Unfinalized DVD-VR format discs may not be played in this player.
- Some DVD-VR discs are made with CPRM data by DVD RECORDER. This unit cannot support these kinds of discs.

### Playing a file on disc/USB device

#### MOVIE MUSIC PHOTO

This player can play movie, music and photo files contained in the disc or USB device.

1. Insert a data disc on the tray or connect a USB device.
2. Press HOME (🏠).
3. Select [Movie], [Photo] or [Music] using ◀/▶, and press ENTER (⊙).
4. Select [Data] or [USB] option using ▲/▼, and press ENTER (⊙).
5. Select a file using ▲/▼/◀/▶, and press ► (PLAY) or ENTER (⊙) to play the file.

## Basic operations for video and audio content

### To stop playback

Press ■ (STOP) while playback.

### To pause playback

Press || (PAUSE) while playback.  
Press ► (PLAY) to resume playback.

### To play frame-by-frame (Video)

Press || (PAUSE) while movie playback.  
Press || (PAUSE) repeatedly to play Frame-by-Frame playback.

### To scan forward or backward

Press ◀◀ or ▶▶ to play fast forward or fast reverse during playback.

You can change the various playback speeds by pressing ◀◀ or ▶▶ repeatedly.

### To slow down the playing speed

While the playback is paused, press ▶▶ repeatedly to play various speeds of slow motion.

### To skip to the next/previous chapter/track/file

During playback, press ◀◀◀ or ▶▶▶ to go to the next chapter/track/file or to return to the beginning of the current chapter/track/file.

Press ◀◀◀ twice briefly to step back to the previous chapter/track/file.

## Basic operations for photo content

### To play a slide show

Press ► (PLAY) to start slide show.

### To stop a slide show

Press ■ (STOP) while slide show.

### To pause a slide show

Press || (PAUSE) while slide show.  
Press ► (PLAY) to re-start the slide show.

### To skip to the next/previous photo

While viewing a photo in full screen, press ◀ or ▶ to go to the previous or next photo.

## Using the disc menu

**BD DVD AVCHD**

### To display the disc menu

The menu screen may be displayed first after loading a disc which contains a menu. If you want to display the disc menu while playback, press DISC MENU.

Use ▲/▼/◀/▶ buttons to navigate through menu items.

### To display the Pop-up menu

Some BD-ROM discs contain Pop-up menu that appears while playback.

Press TITLE/POP-UP while playback, and use ▲/▼/◀/▶ buttons to navigate through menu items.

## Resume playback

**BD DVD AVCHD MOVIE ACD**  
**MUSIC**

The unit records the point where you pressed the **■** (STOP) depending on the disc.

If "II **■** (Resume Stop)" appears on the screen briefly, press **▶** (PLAY) to resume playback (from the scene point).

If you press **■** (STOP) twice or unload the disc, "**■** (Complete Stop)" appears on the screen. The unit will clear the stopped point.

### ! Note

- The resume point may be cleared when a button is pressed (for example; **⏻** (POWER), **▲** (OPEN/CLOSE), etc).
- On BD-ROM discs with BD-J, the resume playback function does not work.
- If you press **■** (STOP) once during BD-ROM interactive title playback, the unit will be in Complete Stop mode.

## Last Scene Memory

**BD DVD**

This unit memorizes the last scene from the last disc that is viewed. The last scene remains in memory even if you remove the disc from the unit or switch off the unit. If you load a disc that has the scene memorized, the scene is automatically recalled.

### ! Note

- Last Scene Memory function for a previous disc is erased once a different disc is played.
- This function may not work depending on the disc.
- On BD-ROM discs with BD-J, the last scene memory function does not work.
- This unit does not memorize settings of a disc if you switch off the unit before commencing to play it.

## Advanced Playback

### Repeat Playback

**BD DVD AVCHD ACD MUSIC**  
**MOVIE**

During playback, press REPEAT (**↺↻**) repeatedly to select a desired repeat mode.

#### Blu-ray Disc / DVD / Movie files

**↺A-** – Selected portion will be repeated continually. (page 30)

**↺Chapter** – The current chapter will be played back repeatedly.

**↺Title** – The current title will be played back repeatedly.

**↺All** – All the tracks or files will be played back repeatedly.

To return to normal playback, press REPEAT (**↺↻**) repeatedly to select [Off].

#### Audio CDs/Music files

**↺Track** – The current track or file will be played back repeatedly.

**↺All** – All the tracks or files will be played back repeatedly.

**↺X** – The tracks or files will be played back in random order.

**↺X↺All** – All the tracks or files will be played back repeatedly in random order.

**↺A-B** – Selected portion will be repeated continually. (Audio CD only)

To return to normal playback, press CLEAR.

### ! Note

- If you press **▶▶** once during Repeat Chapter/Track playback, the repeat playback cancels.
- This function may not work on some disc or title.

## Repeating a specific portion

### BD DVD AVCHD ACD MOVIE

This player can repeat a portion you have selected.

1. While playback, press REPEAT (↺↻) to select [A-] at the beginning of the portion you wish to repeat.
2. Press ENTER (⊙) at the end of the portion. Your selected portion will be repeated continually.
3. To return to normal playback, press REPEAT (↺↻) repeatedly to select [Off].

#### ! Note

- You cannot select a portion less than 3 seconds.
- This function may not work on some disc or title.

## Viewing content information

### MOVIE

The player can display the content information.

1. Select a file using ▲/▼/◀/▶.
2. Press INFO/MENU (⏏) to display the option menu.
3. Select the [Information] option using ▲/▼, and press ENTER (⊙).

The file information appears on the screen.

While movie playback, you can display the file information by pressing TITLE/POP-UP.

#### ! Note

The information displayed on the screen may not correct comparing actual content information.

## Changing content list view

### MOVIE MUSIC PHOTO

On the [Movie], [Music] or [Photo] menu, you can change the content list view.

#### Method 1

Press red (R) coloured button repeatedly.

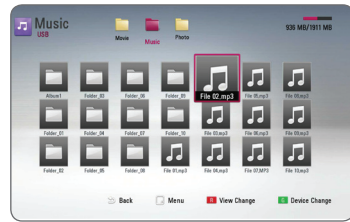

#### Method 2

1. On the content list, press INFO/MENU (⏏) to display the option menu.
2. Use ▲/▼ to select the [View Change] option.
3. Press ENTER (⊙) to change the content list view.

## Selecting a subtitle file

### MOVIE

If the subtitle file name is different from the movie file name, you need to select the subtitle file on the [Movie] menu before playing the movie.

1. Use ▲/▼/◀/▶ to select the subtitle file you wish to play in the [Movie] menu.
2. Press ENTER (⊙).



Press ENTER (⊙) again to deselect the subtitle file. Selected subtitle file will be displayed when you play the movie file.



### Note

If you press ■ (STOP) while playback, the subtitle selection is cancelled.

## Options while viewing a photo

### PHOTO

You can use various options during viewing a photo in full screen.

1. While viewing a photo in full screen, press INFO/MENU (⏏) to display the option menu.
2. Select an option using ▲/▼.



**1 Current photo/Total number of photos**  
– Use ◀/▶ to view previous/next photo.

**2 Slide Show** – Press ENTER (⊙) to start or pause slide show.

**3 Music Select** – Select the background music for the slide show (page 32).

**4 Music** – Press ENTER (⊙) to start or pause background music.

**5 Rotate** – Press ENTER (⊙) to rotate the photo clockwise.

**6 Zoom** – Press ENTER (⊙) to display the [Zoom] menu.

**7 Effect** – Use ◀/▶ to select a transition effect between photos in a slide show.

**8 Speed** – Use ◀/▶ to select a delaying speed between photos in a slide show.

3. Press BACK (⏪) to exit the option menu.

## Listening to music while slide show

### PHOTO

You can display photo files while listening to music files.

1. While viewing a photo in full screen, press INFO/MENU (⏏) to display the option menu.
2. Use ▲/▼ to select [Music Select] option, and press ENTER (⏏) to display the [Music Select] menu.
3. Use ▲/▼ to select a device, and press ENTER (⏏).
4. Use ▲/▼ to select a file or a folder you wish to play.

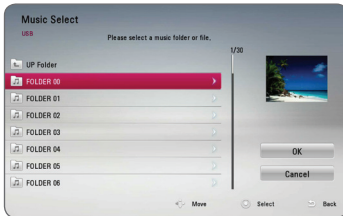

Select [UP Folder] and press ENTER (⏏) to display the upper directory.

5. Use ▶ to select [OK], and press ENTER (⏏) to complete music selection.

## On-Screen display

You can display and adjust various information and settings about the content.

### Displaying content information on-screen

#### BD DVD AVCHD MOVIE

1. While playback, press INFO/MENU (⏏) to show various playback information.



**1 Title** – current title number/total number of titles

**2 Chapter** – current chapter number/total number of chapters

**3 Time** – elapsed playing time/total playback time

**4 Audio** – selected audio language or channel

**5 Subtitle** – selected subtitle.

**6 Angle** – selected angle/total number of angles

**7 TV Aspect Ratio** – selected TV aspect Ratio

**8 Picture Mode** – selected picture mode



2. Select an option using ▲/▼.
3. Use ◀/▶ to adjust the selected option value.
4. Press BACK (⏪) to exit the On-Screen display.

**! Note**

- If no button is pressed for a few seconds, the on-screen display disappears.
- A title number cannot be selected on some discs.
- Available items may differ depending on discs or titles.
- If an interactive Blu-ray Disc is playing back, some setting information is displayed on the screen but prohibited to be changed.

## Playing from selected time

### BD DVD AVCHD MOVIE

1. Press INFO/MENU (⏸) during playback. The time search box shows the elapsed playing time.
2. Select the [Time] option and then input the required start time in hours, minutes, and seconds from left to right.  
For example, to find a scene at 2 hours, 10 minutes, and 20 seconds, enter "21020".  
Press ◀/▶ to skip the playback 60 seconds forward or backward.
3. Press ENTER (⏹) to start playback from selected time.

**! Note**

This function may not work on some disc or titles.

## Selecting a subtitle language

### BD DVD AVCHD MOVIE

1. During playback, press INFO/MENU (⏸) to display the On-Screen display.
2. Use ▲/▼ to select the [Subtitle] option.
3. Use ◀/▶ to select desired subtitle language.
4. Press BACK (⏪) to exit the On-Screen display.

**! Note**

- Some discs allow you to change subtitle selections only via the disc menu. If this is the case, press TITLE/POP-UP or DISC MENU button and choose the appropriate subtitle from the selections on the disc menu.
- You can select the [Subtitle] option on the On-Screen display directly by pressing SUBTITLE (⋮) button.

## Hearing a different audio

**BD DVD AVCHD MOVIE**

1. During playback, press INFO/MENU (□) to display the On-Screen display.
2. Use ▲/▼ to select the [Audio] option.
3. Use ◀/▶ to select desired audio language, audio track or audio channel.

### ! Note

- Some discs allow you to change audio selections only via the disc menu. In this case, press TITLE/POP-UP or DISC MENU button and choose the appropriate audio from the selections on the disc menu.
- Immediately after you have switched sound, there may be a temporary discrepancy between the display and actual sound.
- On BD-ROM disc, the multi audio format (5.1CH or 7.1CH) is displayed with [MultiCH] in the on-screen display.
- You can select the [Audio] option on the On-Screen display directly by pressing AUDIO (Ⓞ) button.

## Changing the TV Aspect Ratio

**BD AVCHD MOVIE**

You can change the TV aspect ratio setting while playback.

1. During playback, press INFO/MENU (□) to display the On-Screen display.
2. Use ▲/▼ to select the [TV Aspect Ratio] option.
3. Use ◀/▶ to select desired option.
4. Press BACK (↶) to exit the On-Screen display.

### ! Note

Even if you change the value of the [TV Aspect Ratio] option in On-Screen display, the [TV Aspect Ratio] option in the [Setup] menu is not changed.

## Watching from a different angle

**BD DVD AVCHD**

If the disc contains scenes recorded at different camera angles, you can change to a different camera angle during playback.

1. During playback, press INFO/MENU (□) to display the On-Screen display.
2. Use ▲/▼ to select the [Angle] option.
3. Use ◀/▶ to select desired angle.
4. Press BACK (↶) to exit the On-Screen display.

## Changing subtitle code page

### MOVIE

If the subtitle is displayed in broken letter, you can change the subtitle code page to view the subtitle file properly.

1. During playback, press INFO/MENU (□) to display the playback menu.
2. Use ▲/▼ to select the [Code Page] option.
3. Use ◀/▶ to select desired code option.

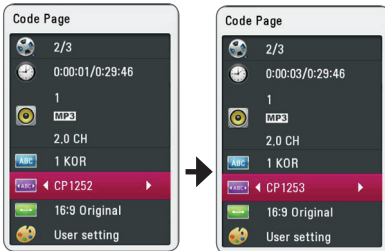

4. Press BACK (⏪) to exit the On-Screen display.

## Changing the Picture Mode

### BD DVD AVCHD MOVIE

You can change the [Picture mode] option while playback.

1. During playback, press INFO/MENU (□) to display the On-Screen display.
2. Use ▲/▼ to select the [Picture Mode] option.
3. Use ◀/▶ to select desired option.
4. Press BACK (⏪) to exit the On-Screen display.

### Setting the [User setting] option

1. During playback, press INFO/MENU (□) to display the On-Screen display.
2. Use ▲/▼ to select the [Picture Mode] option.
3. Use ◀/▶ to select the [User setting] option, and press ENTER (⊙).

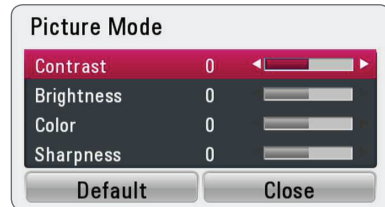

4. Use ▲/▼/◀/▶ to adjust the [Picture Mode] options.  
Select [Default] option then press ENTER (⊙) to reset the all video adjustments.
5. Use ▲/▼/◀/▶ to select the [Close] option, and press ENTER (⊙) to finish setting.

# Troubleshooting

## General

Symptom	Cause & Solution
The Power does not turned on.	<ul style="list-style-type: none"> <li>• Plug the power cord into the wall outlet securely.</li> </ul>
The unit does not start playback.	<ul style="list-style-type: none"> <li>• Insert a playable disc. (Check the disc type, colour system, and regional code.)</li> <li>• Place the disc with the playback side down.</li> <li>• Place the disc on the disc tray correctly inside the guide.</li> <li>• Clean the disc.</li> <li>• Cancel the Rating function or change the rating level.</li> </ul>
The angle cannot be changed.	<ul style="list-style-type: none"> <li>• Multi-angles are not recorded on the DVD Video being played.</li> </ul>
Cannot play movie, photo or music files.	<ul style="list-style-type: none"> <li>• The files are not recorded in a format that the unit can play.</li> <li>• The unit does not support the codec of the movie file.</li> </ul>
The remote control does not work properly.	<ul style="list-style-type: none"> <li>• The remote control is not pointed at the remote sensor of the unit.</li> <li>• The remote control is too far from the unit.</li> <li>• There is an obstacle in the path of the remote control and the unit.</li> <li>• The battery in the remote control is exhausted.</li> </ul>
The unit is plugged in, but the power will not turn on or off.	<p>You can reset the unit as follows.</p> <ul style="list-style-type: none"> <li>• Unplug the power cord, wait at least five seconds, and then plug it in again.</li> </ul>
The unit is not operating normally.	

## Picture

Symptom	Cause & Solution
There is no picture.	<ul style="list-style-type: none"> <li>• Select the appropriate video input mode on the TV so the picture from the unit appears on the TV screen.</li> <li>• Connect the video connection securely.</li> <li>• Check the [HDMI Color Setting] in the [Setup] menu is set to the appropriate item that conforms to your video connection.</li> <li>• Your TV may not support the resolution you have set on the player. Change the resolution that your TV accepts.</li> <li>• The player's HDMI OUT jack is connected to a DVI device that does not support copyright protection.</li> </ul>
Picture noise appears.	<ul style="list-style-type: none"> <li>• You are playing a disc recorded in a colour system that is different from your TV.</li> <li>• Set the resolution which your TV accepts.</li> </ul>

## Customer Support

You can update the Player using the latest software to enhance the products operation and/or add new features. To obtain the latest software for this player (if updates have been made), please visit <http://www.lg.com/global/support> or contact LG Electronics customer care centre.

## Open source software notice

To obtain the corresponding source code under GPL, LGPL and other open source licenses, please visit <http://opensource.lge.com>. All referred license terms, warranty disclaimers and copyright notices are available to download with the source code.

## Controlling a TV with the Supplied Remote Control

You can control your TV using the buttons below.

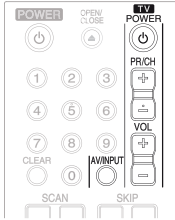

By pressing	You can
⏻ (TV POWER)	Turn the TV on or off.
PR/CH +/-	Scan up or down through memorized channels.
VOL +/-	Adjust the volume of the TV
AV/INPUT	Switch the TV's input source between the TV and other input sources.

### ! Note

Depending on the unit being connected, you may not be able to control your TV using some of the buttons.

## Setting up the remote to control your TV

You can operate your TV with the supplied remote control.

If your TV is listed in the table below, set the appropriate manufacturer code.

1. While holding down ⏻ (TV POWER) button, and press the manufacturer code for your TV with the numerical buttons (see the table below).

Manufacturer	Code Number
LG	1(Default), 2
Zenith	1, 3, 4
GoldStar	1, 2
Samsung	6, 7
Sony	8, 9
Hitachi	4

2. Release the ⏻ (TV POWER) button to complete setting.

Depending on your TV, some or all buttons may not function on the TV, even after entering the correct manufacturer code. When you replace the batteries of the remote, the code number you have set may be reset to the default setting. Set the appropriate code number again.

## Area Code List

Choose an area code from this list.

Area	Code	Area	Code	Area	Code	Area	Code
Afghanistan	AF	Fiji	FJ	Monaco	MC	Singapore	SG
Argentina	AR	Finland	FI	Mongolia	MN	Slovak Republic	SK
Australia	AU	France	FR	Morocco	MA	Slovenia	SI
Austria	AT	Germany	DE	Nepal	NP	South Africa	ZA
Belgium	BE	Great Britain	GB	Netherlands	NL	South Korea	KR
Bhutan	BT	Greece	GR	Antilles	AN	Spain	ES
Bolivia	BO	Greenland	GL	New Zealand	NZ	Sri Lanka	LK
Brazil	BR	Hong Kong	HK	Nigeria	NG	Sweden	SE
Cambodia	KH	Hungary	HU	Norway	NO	Switzerland	CH
Canada	CA	India	IN	Oman	OM	Taiwan	TW
Chile	CL	Indonesia	ID	Pakistan	PK	Thailand	TH
China	CN	Israel	IL	Panama	PA	Turkey	TR
Colombia	CO	Italy	IT	Paraguay	PY	Uganda	UG
Congo	CG	Jamaica	JM	Philippines	PH	Ukraine	UA
Costa Rica	CR	Japan	JP	Poland	PL	United States	US
Croatia	HR	Kenya	KE	Portugal	PT	Uruguay	UY
Czech Republic	CZ	Kuwait	KW	Romania	RO	Uzbekistan	UZ
Denmark	DK	Libya	LY	Russian Federation	RU	Vietnam	VN
Ecuador	EC	Luxembourg	LU	Saudi Arabia	SA	Zimbabwe	ZW
Egypt	EG	Malaysia	MY	Senegal	SN		
El Salvador	SV	Maldives	MV				
Ethiopia	ET	Mexico	MX				

## Language code List

Use this list to input your desired language for the following initial settings: [Disc Audio], [Disc Subtitle] and [Disc Menu].

Language	Code	Language	Code	Language	Code	Language	Code
Afar	6565	French	7082	Lithuanian	7684	Sindhi	8368
Afrikaans	6570	Frisian	7089	Macedonian	7775	Singhalese	8373
Albanian	8381	Galician	7176	Malagasy	7771	Slovak	8375
Amharic	6577	Georgian	7565	Malay	7783	Slovenian	8376
Arabic	6582	German	6869	Malayalam	7776	Spanish	6983
Armenian	7289	Greek	6976	Maori	7773	Sudanese	8385
Assamese	6583	Greenlandic	7576	Marathi	7782	Swahili	8387
Aymara	6588	Guarani	7178	Moldavian	7779	Swedish	8386
Azerbaijani	6590	Gujarati	7185	Mongolian	7778	Tagalog	8476
Bashkir	6665	Hausa	7265	Nauru	7865	Tajik	8471
Basque	6985	Hebrew	7387	Nepali	7869	Tamil	8465
Bengali; Bangla	6678	Hindi	7273	Norwegian	7879	Telugu	8469
Bhutani	6890	Hungarian	7285	Oriya	7982	Thai	8472
Bihari	6672	Icelandic	7383	Panjabi	8065	Tonga	8479
Breton	6682	Indonesian	7378	Pashto, Pushto	8083	Turkish	8482
Bulgarian	6671	Interlingua	7365	Persian	7065	Turkmen	8475
Burmese	7789	Irish	7165	Polish	8076	Twi	8487
Byelorussian	6669	Italian	7384	Portuguese	8084	Ukrainian	8575
Chinese	9072	Japanese	7465	Quechua	8185	Urdu	8582
Croatian	7282	Kannada	7578	Rhaeto-Romance	8277	Uzbek	8590
Czech	6783	Kashmiri	7583	Rumanian	8279	Vietnamese	8673
Danish	6865	Kazakh	7575	Russian	8285	Volapük	8679
Dutch	7876	Kirghiz	7589	Samoan	8377	Welsh	6789
English	6978	Korean	7579	Sanskrit	8365	Wolof	8779
Esperanto	6979	Kurdish	7585	Scots Gaelic	7168	Xhosa	8872
Estonian	6984	Laotian	7679	Serbian	8382	Yiddish	7473
Faroese	7079	Latin	7665	Serbo-Croatian	8372	Yoruba	8979
Fiji	7074	Latvian, Lettish	7686	Shona	8378	Zulu	9085
Finnish	7073	Lingala	7678				



## Trademarks and Licenses



Blu-ray Disc™, Blu-ray™, BONUSVIEW™ and the logos are trademarks of the Blu-ray Disc Association.



"DVD Logo" is a trademark of DVD Format/Logo Licensing Corporation.



Java is a trademark of Oracle and/or its affiliates.



HDMI, the HDMI logo and High-Definition Multimedia Interface are trademarks or registered trademarks of HDMI Licensing LLC in the United States and other countries.

"x.v.Colour" is a trademark of Sony Corporation.



Manufactured under license from Dolby Laboratories. Dolby and the double-D symbol are trademarks of Dolby Laboratories.



Manufactured under license under U.S. Patent Nos: 5,956,674; 5,974,380; 6,487,535 & other U.S. and worldwide patents issued & pending. DTS, the Symbol, & DTS and the Symbol together are registered trademarks & DTS 2.0+Digital Out is a trademark of DTS, Inc. Product includes software. © DTS, Inc. All Rights Reserved.



"AVCHD" and the "AVCHD" logo are trademarks of Panasonic Corporation and Sony Corporation.



DivX®, DivX Certified® and associated logos are trademarks of Rovi Corporation or its subsidiaries and are used under license.

## Cinavia Notice

This product uses Cinavia technology to limit the use of unauthorized copies of some commercially-produced film and videos and their soundtracks. When a prohibited use of an unauthorized copy is detected, a message will be displayed and playback or copying will be interrupted.

More information about Cinavia technology is provided at the Cinavia Online Consumer Information Center at <http://www.cinavia.com>. To request additional information about Cinavia by mail, send a postcard with your mailing address to: Cinavia Consumer Information Center, P.O. Box 86851, San Diego, CA, 92138, USA.

This product incorporates proprietary technology under license from Verance Corporation and is protected by U.S. Patent 7,369,677 and other U.S. and worldwide patents issued and pending as well as copyright and trade secret protection for certain aspects of such technology. Cinavia is a trademark of Verance Corporation. Copyright 2004-2010 Verance Corporation. All rights reserved by Verance. Reverse engineering or disassembly is prohibited.

## Audio Output Specifications

Jack/Setting Source	COAXIAL (DIGITAL AUDIO OUT) * <sup>3</sup>		
	PCM Stereo	DTS Re-encode * <sup>4</sup>	BitStream
Dolby Digital	PCM 2ch	DTS	Dolby Digital
Dolby Digital Plus	PCM 2ch	DTS	Dolby Digital
Dolby TrueHD	PCM 2ch	DTS	Dolby Digital
DTS	PCM 2ch	DTS	DTS
DTS-HD	PCM 2ch	DTS	DTS
Linear PCM 2ch	PCM 2ch	DTS	PCM 2ch
Linear PCM 5.1ch	PCM 2ch	DTS	PCM 2ch
Linear PCM 7.1ch	PCM 2ch	DTS	PCM 2ch

Jack/Setting Source	HDMI OUT			
	PCM Stereo	PCM Multi-Ch	DTS Re-encode * <sup>4</sup>	BitStream * <sup>1</sup> * <sup>2</sup>
Dolby Digital	PCM 2ch	PCM 2ch	DTS	Dolby Digital
Dolby Digital Plus	PCM 2ch	PCM 2ch	DTS	Dolby Digital Plus
Dolby TrueHD	PCM 2ch	PCM 2ch	DTS	Dolby TrueHD
DTS	PCM 2ch	PCM 2ch	DTS	DTS
DTS-HD	PCM 2ch	PCM 2ch	DTS	DTS-HD
Linear PCM 2ch	PCM 2ch	PCM 2ch	DTS	Linear PCM 2ch
Linear PCM 5.1ch	PCM 2ch	PCM 5.1ch	DTS	Linear PCM 5.1ch
Linear PCM 7.1ch	PCM 2ch	PCM 7.1ch	DTS	Linear PCM 7.1ch

\*1 The secondary and interactive audio may not be included in the output bitstream if [Digital Output] option is set to [BitStream]. (Except LPCM Codec : the output always include interactive and secondary audio.)

\*2 This player automatically selects the HDMI audio according to the decoding capability of the connected HDMI device even though [Digital Output] option is set to [BitStream].

\*3 On the PCM audio output, the sampling frequency of DIGITAL AUDIO OUT is limited to 96 kHz.

\*4 If the [Digital Output] option is set to [DTS re-encode], the audio output is limited to 48 kHz and 5.1Ch. If the [Digital Output] option is set to [DTS re-encode], the DTS Re-encode audio is outputted for BD-ROM discs, and the original audio is outputted for the other discs (like [BitStream]).

- If the HDMI OUT jack is connected to your TV with High Speed HDMI™ Cable and Dolby Digital Plus/Dolby TrueHD is outputted from HDMI OUT jack, COAXIAL OUT jack is limited to "PCM 2ch" (When the HDMI and DIGITAL AUDIO OUT are connected simultaneously).

- The audio is outputted as PCM 48 kHz/16 bit for MP3/WMA file and PCM 44.1 kHz/16 bit for Audio CD while playback.
- You must select a digital audio output and a maximum sampling frequency that your Amplifier (or AV receiver) accepts using [Digital Output] and [Sampling Freq.] options on the [Setup] menu (see page 24).
- With digital audio connection (DIGITAL AUDIO OUT or HDMI OUT), Disc Menu button sounds of BD-ROM may not be heard if the [Digital Output] option is set to [BitStream].
- If the audio format of the digital output does not match the capabilities of your receiver, the receiver will produce a strong, distorted sound or no sound at all.
- Multi-channel Digital Surround Sound via digital connection can only be obtained if your receiver is equipped with a Digital Multi-channel decoder.

## Specifications

General	
Power requirements	DC 12 V  1 A
AC Adapter	WA-12M12Fx
Dimensions (W x H x D)	Approx. 270 x 39 x 198 mm
Net Weight (Approx.)	0.95 Kg
Operating temperature	5 °C to 35 °C
Operating humidity	5 % to 90 %

Outputs	
HDMI OUT (video/audio)	19 pin (Type A, HDMI™ Connector)
DIGITAL AUDIO OUT (COAXIAL)	0.5 V (p-p), 75 Ω, RCA jack x 1

System	
Laser	Semiconductor laser
wavelength	405 nm / 650 nm
Signal system	Standard PAL/NTSC colour TV system
Bus Power Supply (USB)	DC 5 V  500 mA

- Design and specifications are subject to change without notice.

## Maintenance

### Handling the Unit

#### When shipping the unit

Please save the original shipping carton and packing materials. If you need to ship the unit, for maximum protection, re-pack the unit as it was originally packed at the factory.

#### Cleaning the unit

To clean the player, use a soft, dry cloth. If the surfaces are extremely dirty, use a soft cloth lightly moistened with a mild detergent solution. Do not use strong solvents such as alcohol, benzine, or thinner, as these might damage the surface of the unit.

Keeping the exterior surfaces clean

- Do not use volatile liquids such as insecticide spray near the unit.
- Wiping with strong pressure may damage the surface.
- Do not leave rubber or plastic products in contact with the unit for a long period of time.

#### Maintaining the Unit

The unit is a high-tech, precision device. If the optical pick-up lens and disc drive parts are dirty or worn, the picture quality could be diminished. For details, please contact your nearest authorized service centre.

## Notes on Discs

### Handling Discs

Do not touch the playback side of the disc. Hold the disc by the edges so that fingerprints do not get on the surface. Never stick paper or tape on the disc.

### Storing Discs

After playing, store the disc in its case. Do not expose the disc to direct sunlight or sources of heat and never leave it in a parked car exposed to direct sunlight.

### Cleaning Discs

Fingerprints and dust on the disc can cause poor picture quality and sound distortion. Before playing, clean the disc with a clean cloth. Wipe the disc from the centre to out.

Do not use strong solvents such as alcohol, benzine, thinner, commercially available cleaners, or anti-static spray intended for older vinyl records.







## Free Manuals Download Website

<http://myh66.com>

<http://usermanuals.us>

<http://www.somanuals.com>

<http://www.4manuals.cc>

<http://www.manual-lib.com>

<http://www.404manual.com>

<http://www.luxmanual.com>

<http://aubethermostatmanual.com>

Golf course search by state

<http://golfingnear.com>

Email search by domain

<http://emailbydomain.com>

Auto manuals search

<http://auto.somanuals.com>

TV manuals search

<http://tv.somanuals.com>