

LCD TV | PLASMA TV OWNER'S MANUAL

LCD TV MODELS

26LC4R* 26LC7R*
32LC4R* 32LC7R*
37LC4R* 37LC7R*
42LC4R* 42LC7R*
32LB9R*
42LB9R*

PLASMA TV MODELS

42PC5R*
42PC5RV*
42PC7R*
50PC5R*

Please read this manual carefully before operating your set.
Retain it for future reference.

Record model number and serial number of the set.
Refer to the label on the back cover and quote this
information.

To your dealer when requiring service.

ACCESSORIES

Ensure that the following accessories are included with your TV. If an accessory is missing, please contact the dealer where you purchased the product.

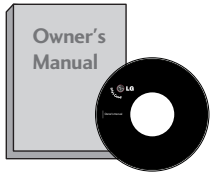

Owner's Manual



Batteries

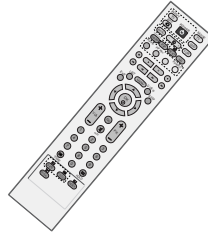

Remote Control



Power Cord

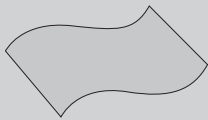

Polishing Cloth
Polishing cloth for use on the screen
This feature is not available
for all models.

*Lightly wipe any stains or fingerprints on the surface of the TV with the polishing cloth.

Do not use excessive force. This may cause scratching or discolouration.

Plasma TV models



2-Wall brackets
This feature is not available
for all models.



2-eye-bolts
This feature is not available
for all models.

LCD TV models



2-TV Brackets
2- Wall Brackets
This feature is not
available for all models.



2-bolts
This feature is not
available
for all models.



Twister Holder
Arrange the wires with
the twister holder.
This feature is not available
for all models.



or



Cable Management

26", 32", 37" only



4-bolts for stand assembly
Refer to p. 8

32LB9R+ only



1-screw for stand fixing
Refer to p. 8

CONTENTS

ACCESSORIES.....	1
------------------	---

PREPARATION

Front Panel Controls.....	4
Back Panel Information	6
Stand Installation.....	8
ATTACHING THE TV TO A DESK (Only 32LB9R* model)	8
Attaching the TV to a Wall.....	9
Back Cover for Wire Arrangement.....	10
Desktop Pedestal Installation	12
Wall Mount: Horizontal installation.....	13
Antenna Connection.....	14

EXTERNAL EQUIPMENT SETUP

HD Receiver Setup	15
DVD Setup.....	18
VCR Setup.....	21
Other A/V Source Setup.....	24
External Stereo.....	25
PC Setup.....	26
- Screen Setup for PC Mode	28

WATCHING TV / PROGRAMME CONTROL

Remote Control Key Functions.....	32
Turning on the TV.....	34
Programme Selection	34
Volume Adjustment.....	34
On Screen Menus Selection and Adjustment	35
Auto Programme Tuning.....	36
Manual Programme Tuning	37
Fine Tuning	38
Assigning a Station Name	39
Programme Edit	40
Favourite Programme	41
Selecting the Programme Table.....	42
Key lock.....	43
 SIMPLINK	44

PICTURE CONTROL

Watching PIP(Picture-in-Picture)	46
Picture Size (Aspect Ratio)Control.....	48
Preset Picture Settings	
- Picture Mode-Preset.....	50
- Auto Colour Tone Control(Warm/Medium/Cool) 51	
Manual Picture Adjustment	
- Picture Mode-User Option.....	52
- Colour Tone - User Option.....	53
XD - Picture Improvement Technology.....	54
XD Demo.....	55
Advanced - Cinema.....	56
Advanced - Black(Darkness) Level.....	57
Picture Reset.....	58
Image Sticking Minimization(ISM) Method.....	59
Low-Power Picture Mode.....	60

SOUND & LANGUAGE CONTROL

Auto Volume Leveler	61
Preset Sound Settings - Sound Mode	62
Sound Setting Adjustment - User Mode	63
Balance	64
TV Speakers On/Off Setup	65
I/II	
- Stereo/Dual Reception.....	66
- NICAM Reception	67
- Speaker Sound Output Selection.....	67
On-Screen Menu Language Selection	68

TIME SETTING

Clock Setup.....	69
Auto On/Off Timer Setting	70
Sleep Timer Setting.....	71
Auto Shut-off Setting.....	72

TELETEXT

Switch On/Off	73
SIMPLE Text.....	73
TOP Text	74
FASTEXT	74
Special Teletext Functions.....	75

APPENDIX

Troubleshooting.....	76
Maintenance	78
Product Specifications	79
Programming the Remote Control	81

PREPARATION

FRONT PANEL CONTROLS

- This is a simplified representation of the front panel. Image shown may differ from your TV.
- If your product has a protection film attached, remove the film and then wipe the product with a polishing cloth.

Plasma TV Models

42/50PC5R*

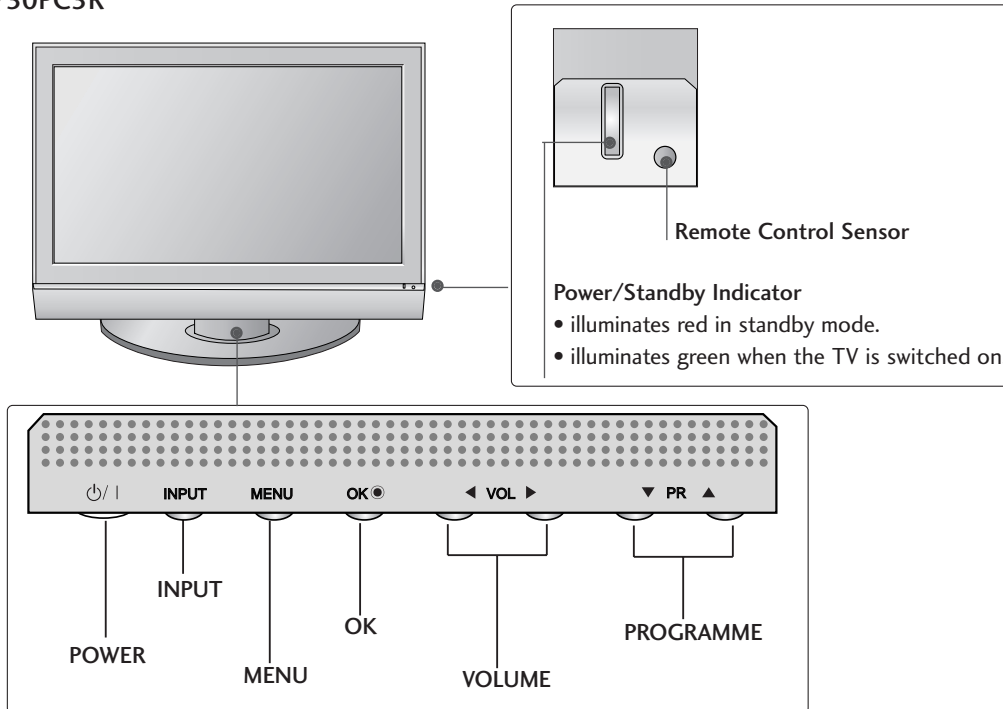

42PC7R*

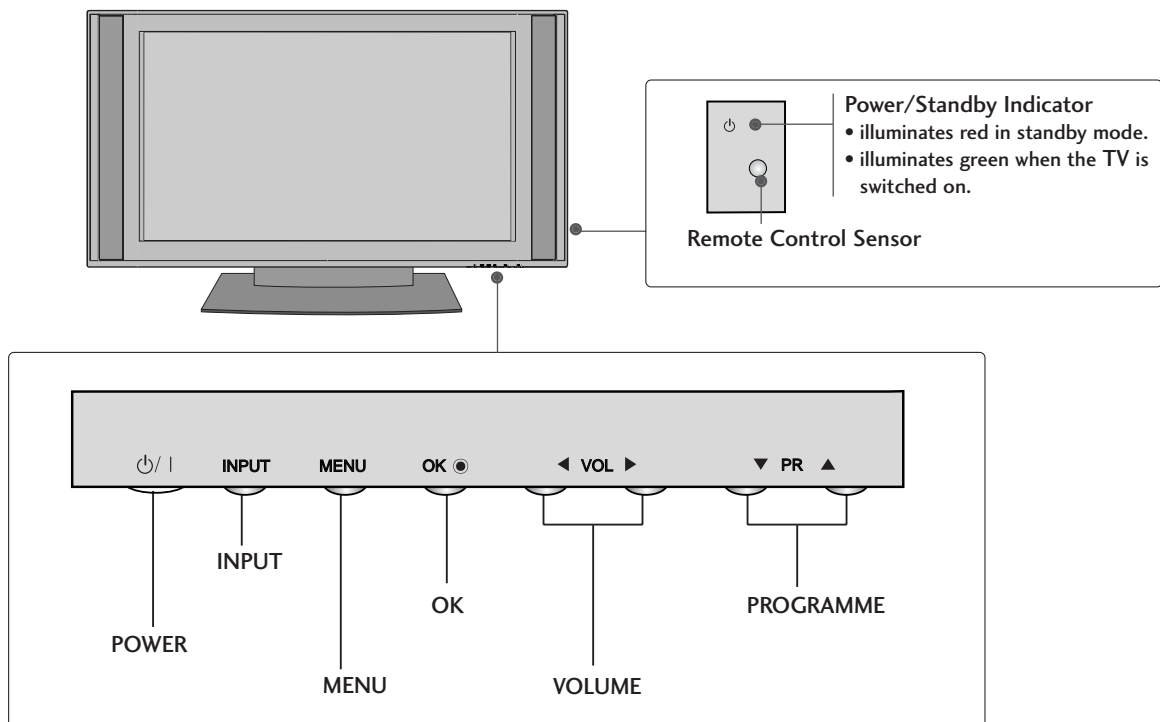

LCD TV Models

26/32/37/42LC4R*
26/32/37/42LC7R*

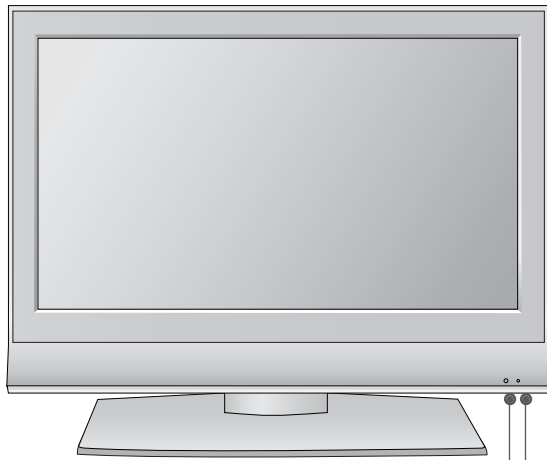

Remote Control Sensor

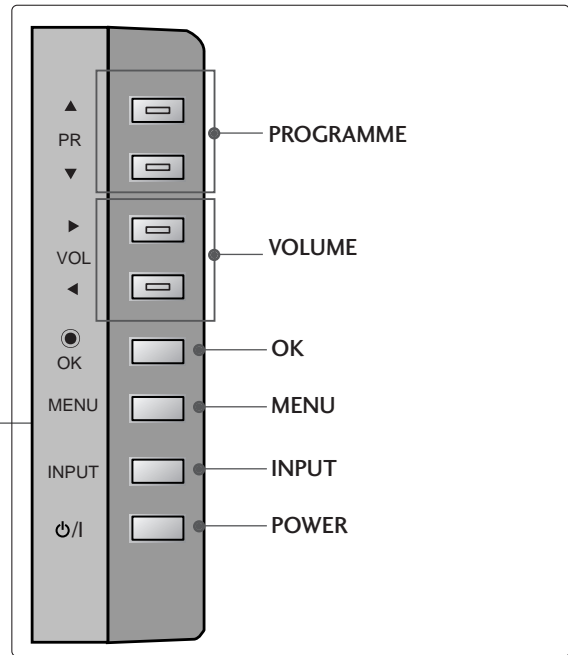

Power/Standby Indicator

- illuminates red in standby mode.
- illuminates green when the TV is switched on.

32/42LB9R*

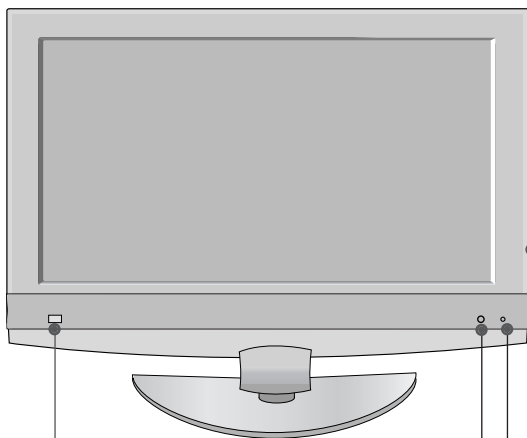

Intelligent Eye
Adjusts picture
according to the
surrounding conditions.

Remote Control
Sensor

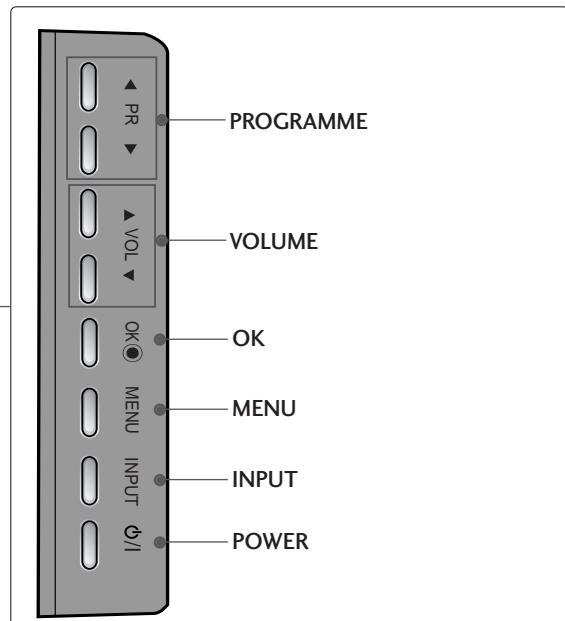

Power/Standby Indicator

- illuminates red in standby mode.
- illuminates green when the TV is switched on.

PREPARATION

BACK PANEL INFORMATION

■ This is a simplified representation of the back panel. Image shown may differ from your TV.

Plasma TV Models

42/50PC5R*

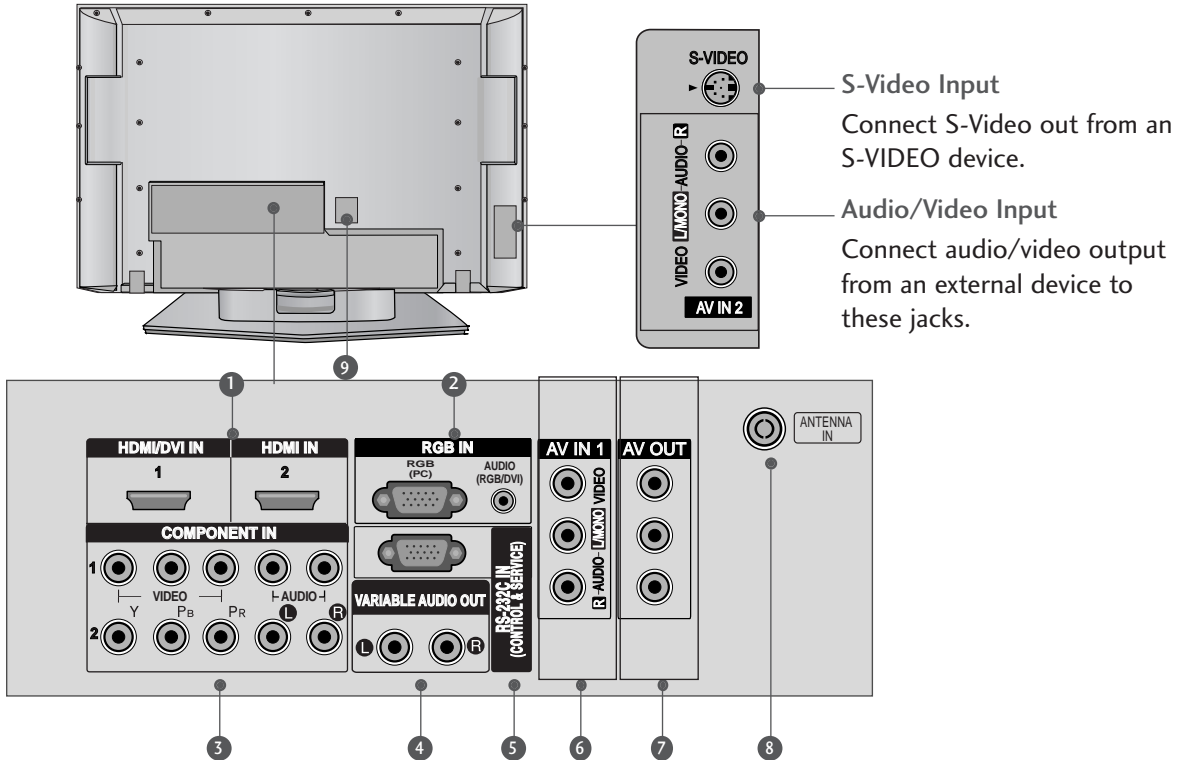

42PC7R*

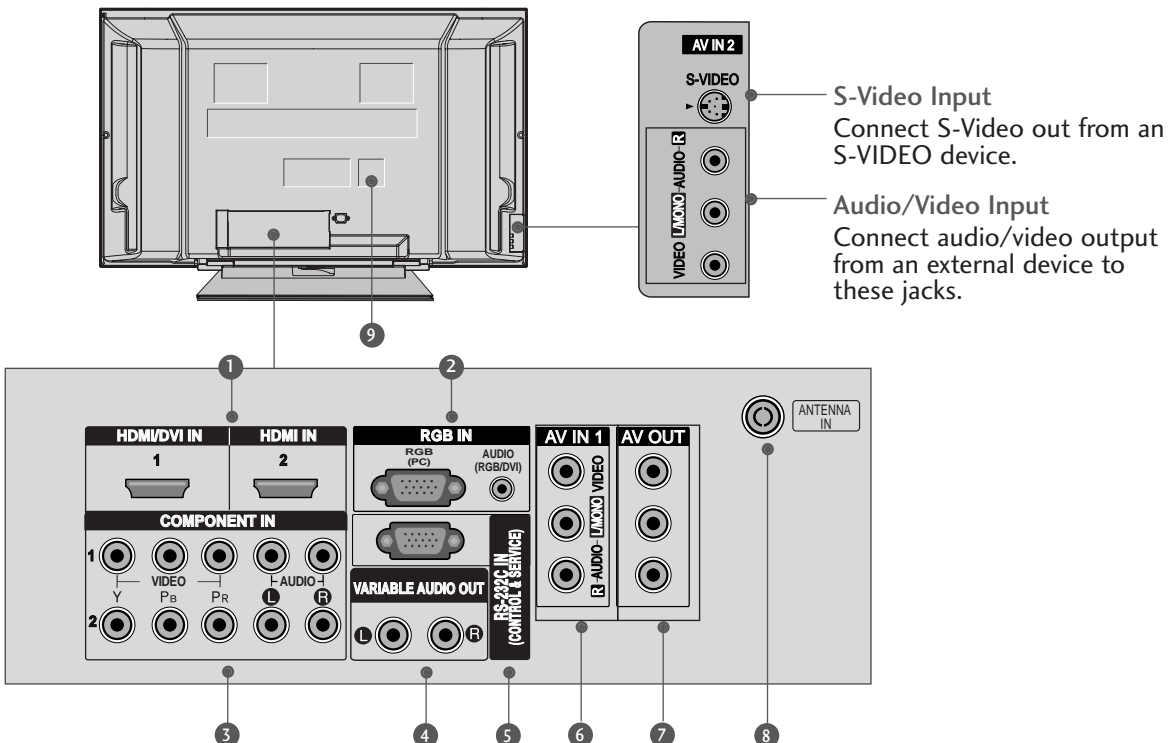

LCD TV Models

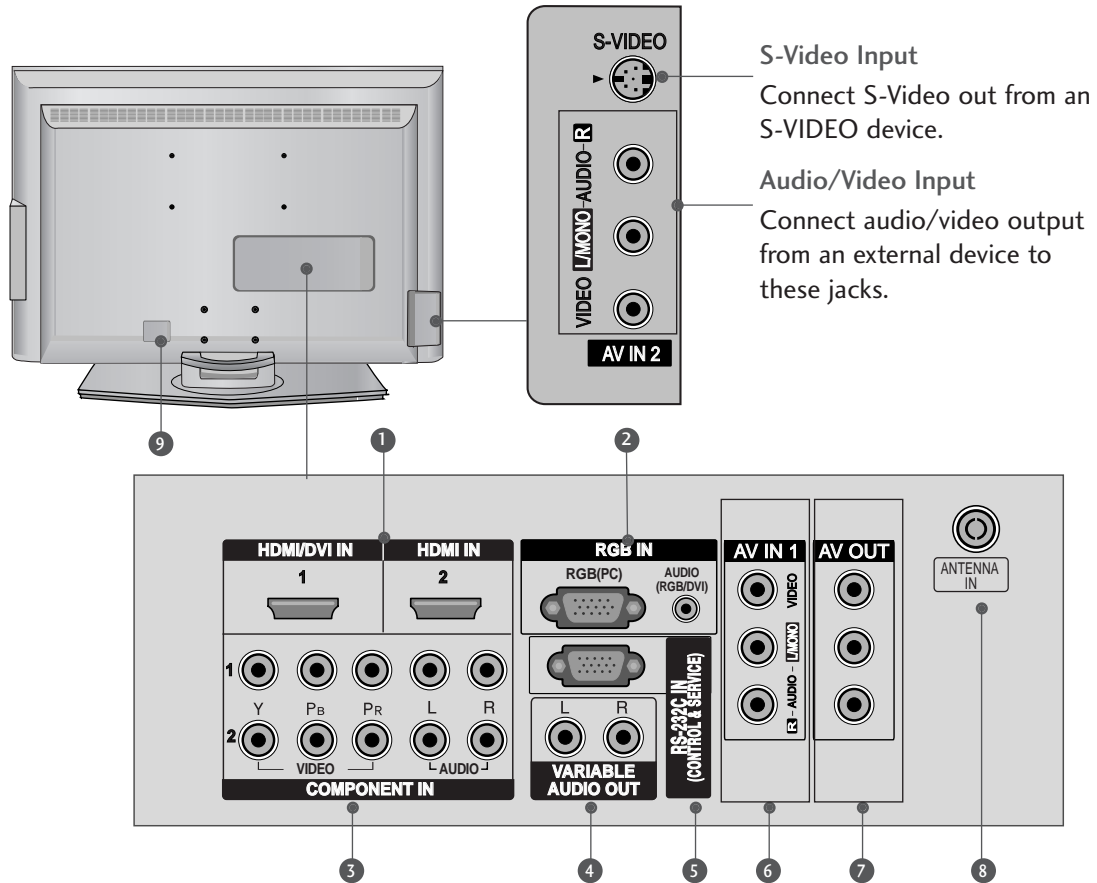

- 1 HDMI Input**
Connect a HDMI signal to HDMI IN.
Or DVI(VIDEO)signal to HDMI/DVI port with DVI to HDMI cable.
- 2 RGB/Audio Input**
Connect the monitor output from a PC to the appropriate input port.
- 3 Component Input**
Connect a component video/audio device to these jacks.
- 4 Variable Audio Output**
Connect an external amplifier or add a subwoofer to your surround sound system.
- 5 RS-232C Input (CONTROL&SERVICE) Port**
Connect the serial port of the control devices to the RS-232C jack.
(This feature is not available for all models.)
- 6 Audio/Video Input (AV IN 1)**
Connect audio/video output from an external device to these jacks.
- 7 AV Output**
Connect second TV or monitor to the AV OUT socket on the TV.
- 8 Antenna Input**
Connect RF antenna (UHF) to this jack.
- 9 Power Cord Socket**
This TV operates on an AC power. The voltage is indicated on the Specifications page. Never attempt to operate the TV on DC power.

PREPARATION

STAND INSTALLATION (Only 26, 32,37 inch LCD TV models)

- 1 Carefully place the TV screen side down on a cushioned surface to protect the screen from damage.

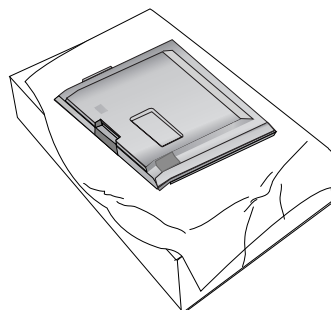

- 2 Assemble the TV as shown.

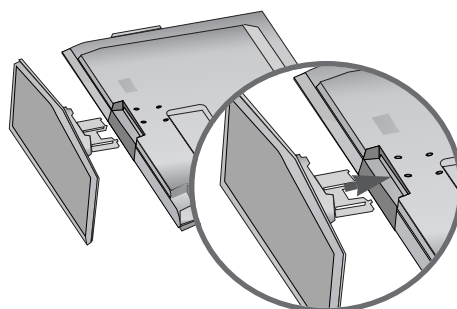

- 3 Fix the 4 bolts securely using the holes in the back of the TV.

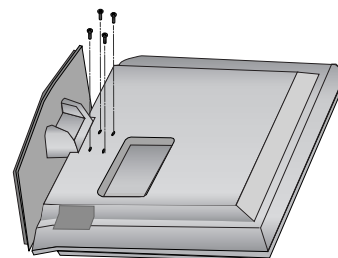

ATTACHING THE TV TO A DESK (Only 32LB9R* model)

If you wish to attach the TV to a desk, it must be securely fastened to the desk using a metal screw (as shown below). Failure to securely attach the TV may result in the TV falling; which may cause damage to the TV and serious personal injury.

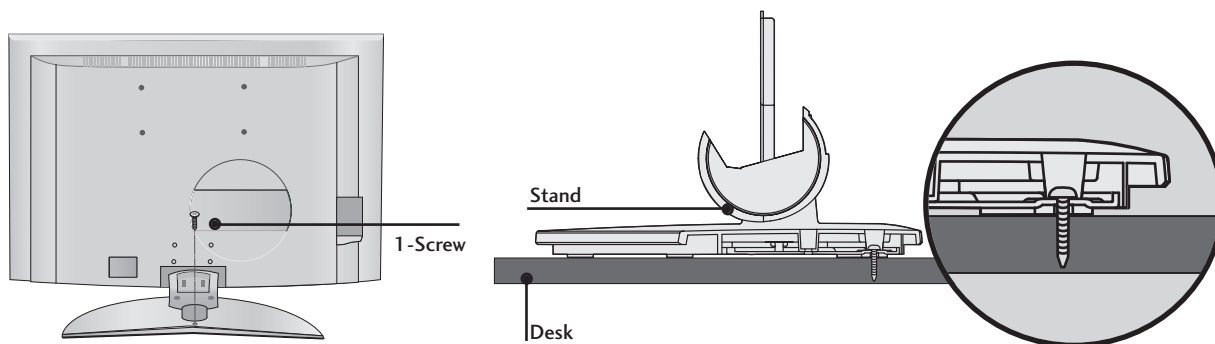

ATTACHING THE TV TO A WALL (This feature is not available for all models.)

- Position the TV close to the wall to avoid the possibility of it falling when pushed.
- The instructions shown below are a safer way to set up the TV, which is to fix it to the wall, avoiding the possibility of it falling forwards if pulled. This will prevent the TV from falling forward and causing injury. This will also prevent the TV from damage. Ensure that children do not climb or hang from the TV.

Plasma TV models

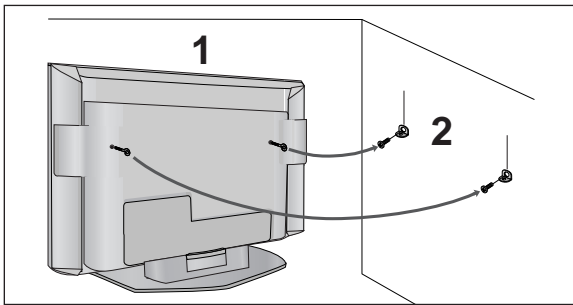

LCD TV models

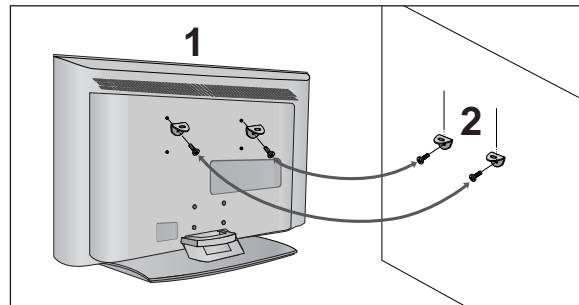

- 1 Use the eye-bolts or TV brackets/bolts to fix the product to the wall as shown in the picture.
(If your TV has bolts in the eyebolts, loosen then bolts.)
* Insert the eye-bolts or TV brackets/bolts and tighten them securely in the upper holes.

- 2 Secure the wall brackets with bolts (must purchase seperately) to the wall.
Ensure that both brackets are even.

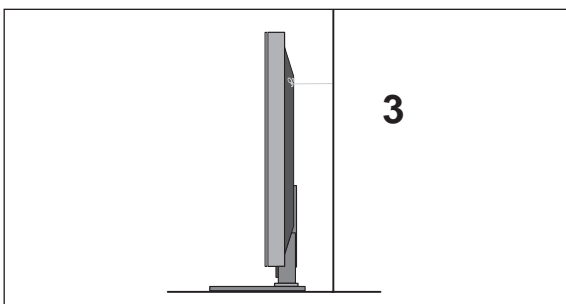

- 3 Use a strong cord (must purchase separately) to secure the TV.
Secure the cord in such a way that it becomes taught when the TV is in position.

! NOTE

- ▶ When moving the TV undo the cords first.
- ▶ Use a platform or cabinet string and large enough to support the size and weight of the TV.
- ▶ To use the TV safely make sure that the height of the bracket on the wall and on the TV is the same.

PREPARATION

BACK COVER FOR WIRE ARRANGEMENT

Plasma TV models

- These models have two cable arrangement methods according to the stand type.

Stand type 1

Arrange the cables as shown picture.

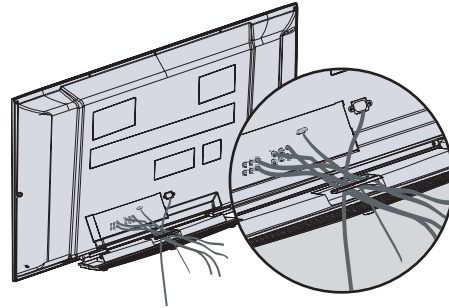

Stand type 2

- 1 Grip the **CABLE MANAGEMENT** and push the cover upwards.

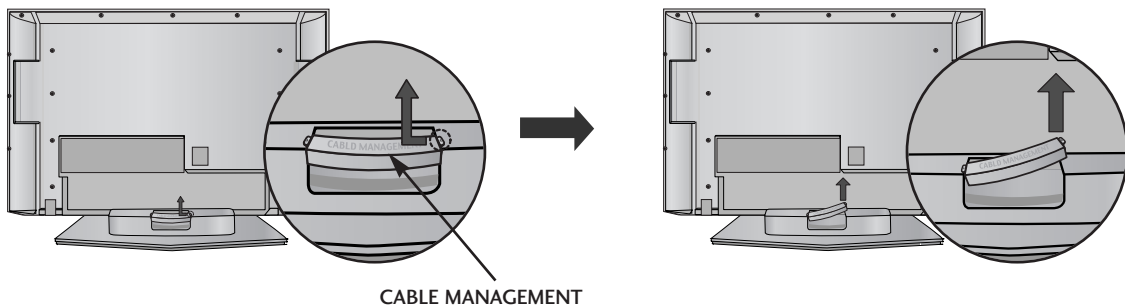

- 2 Connect the cables as necessary.

To connect additional equipment, see the **External equipment Setup** section of the manual.

- 3 Reinstall the **CABLE MANAGEMENT** as shown.



LCD TV models

- 1 Connect the cables as necessary.

To connect additional equipment, see the **External equipment Setup** section.

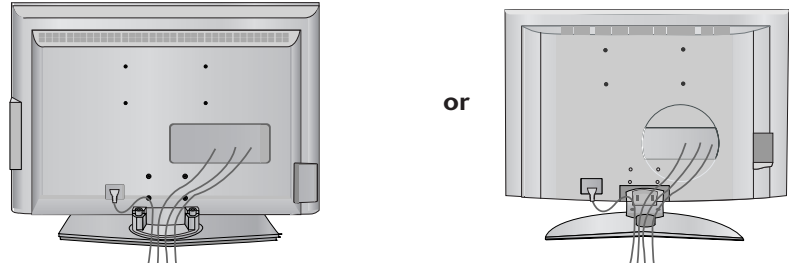

- 2 Install the **CABLE MANAGEMENT** as shown.

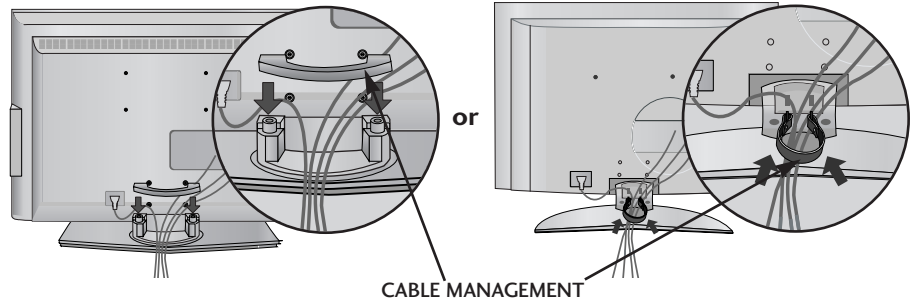

(Insert it as pushing the loops on the both sides of the cable management.)

- 3 Bundle the cables using the supplied twister holder.
(This feature is not available for all models.)

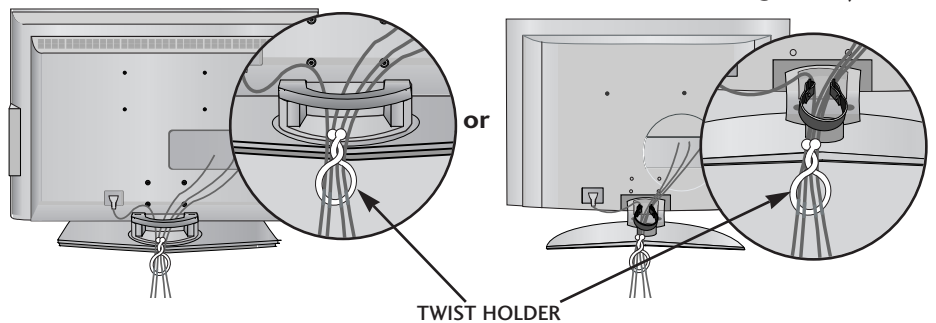

How to remove the cable management

Hold the **CABLE MANAGEMENT** with both hands and pull it upward.

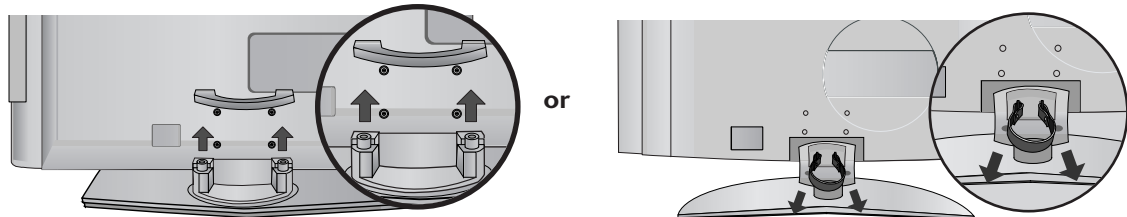

(Pull it out as holding the loops on the both sides of the cable management.)

NOTE

- ▶ Do not use the **CABLE MANAGEMENT** to lift the TV.
- If the TV is dropped, you may be injured or the TV may be damaged.

PREPARATION

- The TV can be installed in various ways such as on a wall, or on a desktop etc.
- The TV is designed to be mounted horizontally.

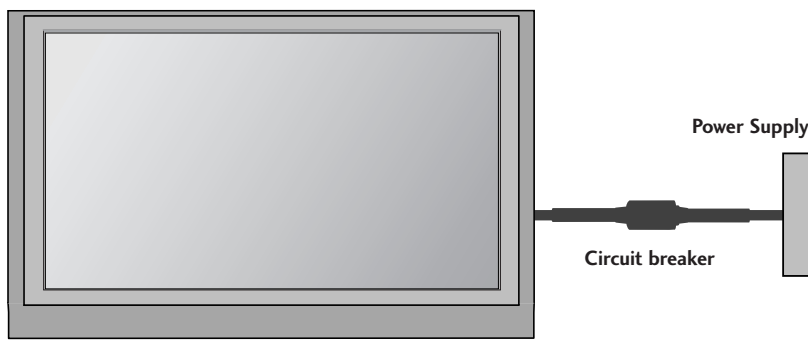

EARTHING

Ensure that you connect the earth wire to prevent possible electric shock. If grounding methods are not possible, have a qualified electrician install a separate circuit breaker.

Do not try to earth the TV by connecting it to telephone wires, lightening rods or gas pipes.

DESKTOP PEDESTAL INSTALLATION

For adequate ventilation allow a clearance of 4" (10cm) all around the TV .

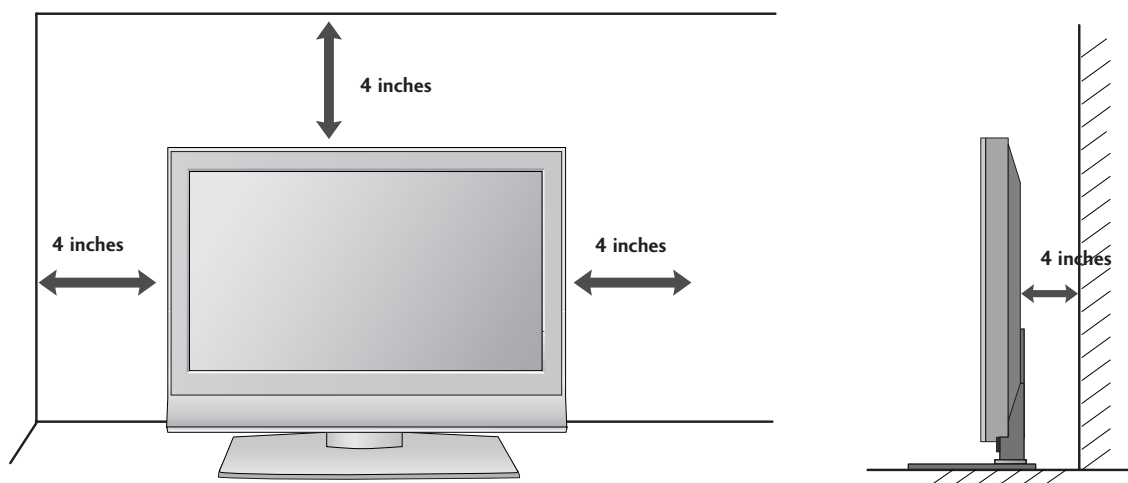

WALL MOUNT: HORIZONTAL INSTALLATION

For adequate ventilation allow a clearance of 4" (10cm) all around the TV. Detailed installation instructions are available from your dealer; see the optional Tilt Wall Mounting Bracket Installation and Setup Guide.

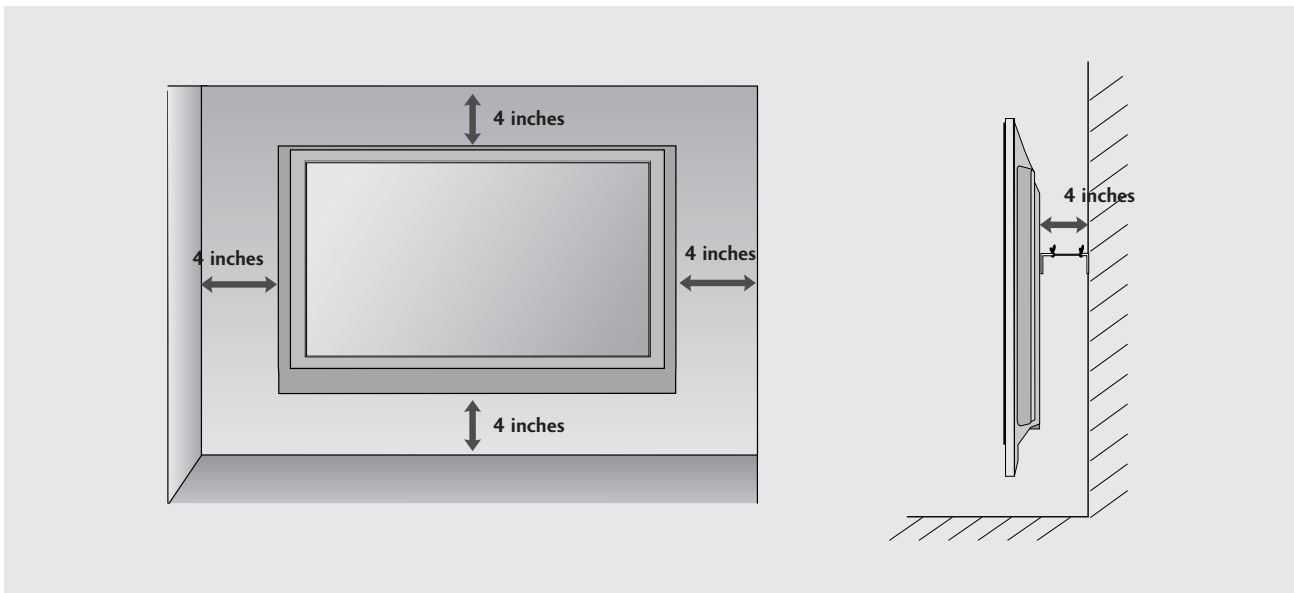

PREPARATION

- It is recommended that 42PC5RH / 42PC5RVH / 50PC5RH / 42PC7RVH model only be used at an altitude of less than 6561 feet (2000m) to get the best quality picture and sound.
- To prevent damage do not connect to the mains outlet until all connections are made between the devices.

ANTENNA CONNECTION

- For optimum picture quality, adjust antenna direction.
- An antenna cable and converter are not supplied.

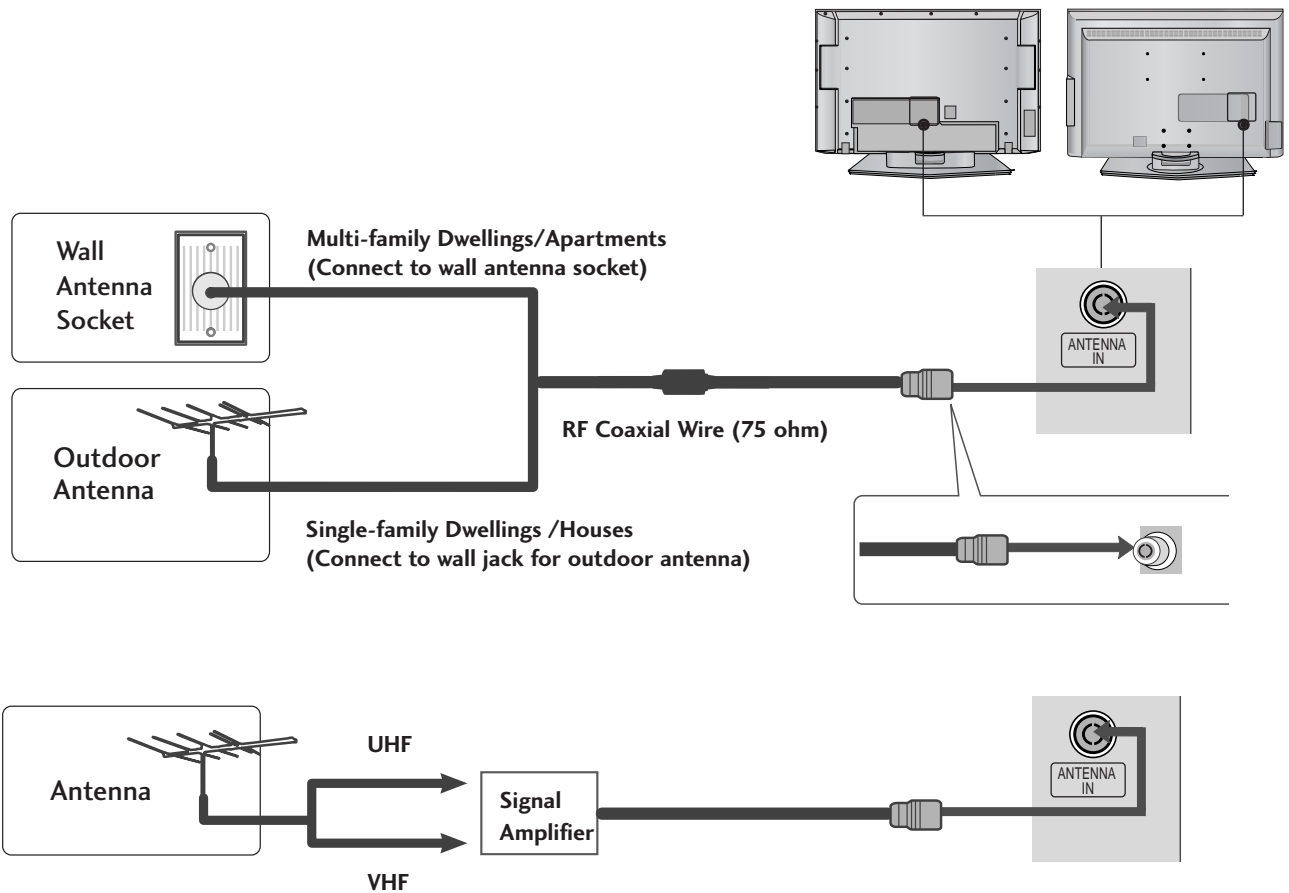

- In poor signal areas, to achieve better picture quality it may be necessary to install a signal amplifier to the antenna as shown above.
- If signal needs to be split for two TVs, use an antenna signal splitter for connection.

EXTERNAL EQUIPMENT SETUP

- To avoid damaging any equipment, never plug in any power cords until you have finished connecting all equipment.
- This section on EXTERNAL EQUIPMENT SETUP mainly uses diagrams for the LCD TV models.

HD RECEIVER SETUP

Connecting with a component cable

- 1 Connect the video outputs (Y, Pb, PR) of the digital TV top box to the **COMPONENT IN VIDEO** jacks on the TV.
- 2 Connect the audio output of the digital set-top box to the **COMPONENT IN AUDIO** jacks on the TV.
- 3 Turn on the digital set-top box.
(Refer to the owner's manual for the digital set-top box.)
- 4 Select **Component1** input source using the **INPUT** button on the remote control.
If connected to **COMPONENT IN2**, select **Component2** input source.

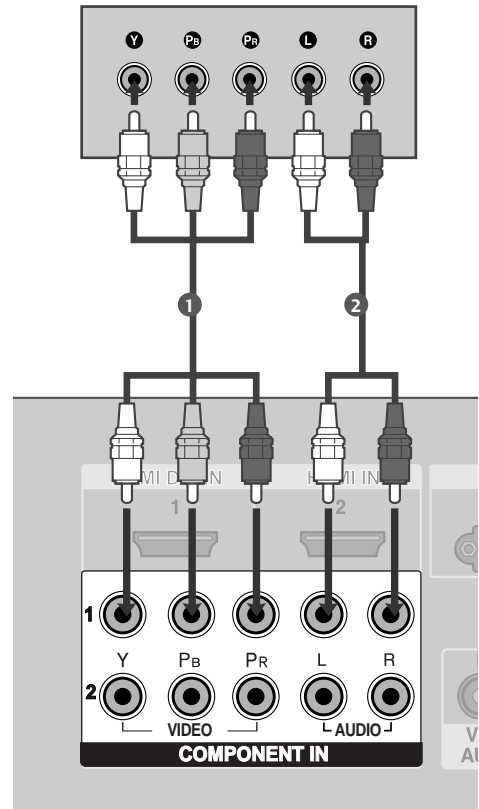

Signal	Component	HDMI1/2
480i/576i	Yes	No
480p/576p	Yes	Yes
720p/1080i	Yes	Yes
1080p	No	Yes

(except VGA Models)

EXTERNAL EQUIPMENT SETUP

Connecting a set-top box with an HDMI cable

- 1 Connect the HDMI output of the digital set-top box to the **HDMI/DVI IN 1** or **HDMI IN 2** jack on the TV.
- 2 Select **HDMI1** or **HDMI2** input source using the **INPUT** button on the remote control.
- 3 Turn on the digital set-top box.
(Refer to the owner's manual for the digital set-top box.)

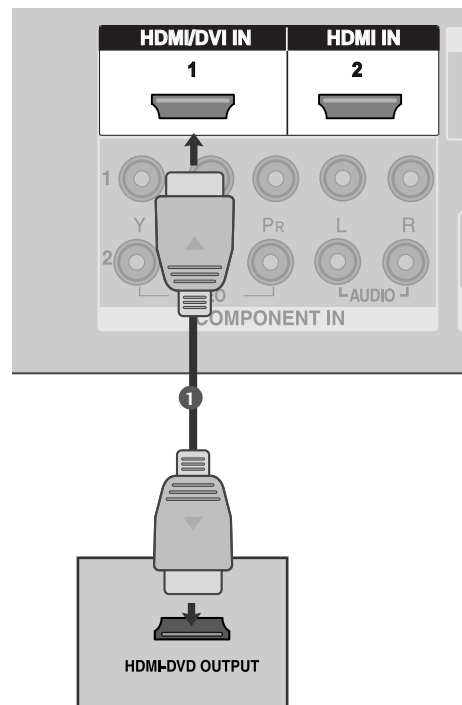

NOTE

- ▶ TV can receive the video and audio signal simultaneously with using a HDMI cable.
- ▶ If the digital set-top box supports Auto HDMI function, the output resolution of the source device will be automatically TV to 1280x720p.
- ▶ If the digital set-top box player does not support Auto HDMI, you need to TV the output resolution appropriately.
To get the best picture quality, adjust the output resolution of the source device to 1280x720p.

Connecting with a HDMI to DVI cable

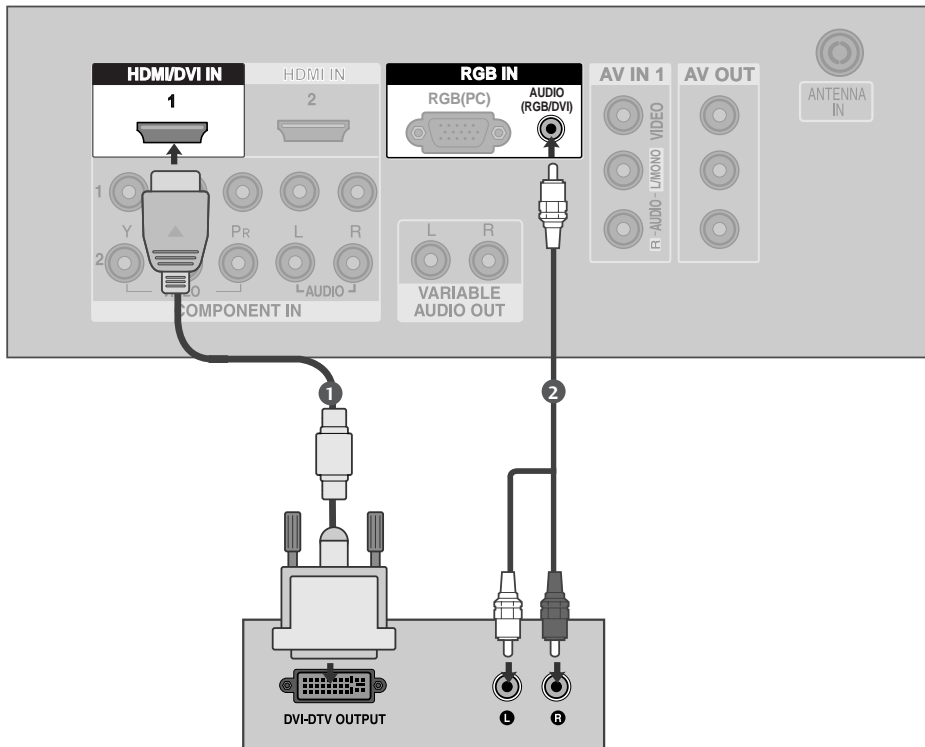

- 1 Connect the DVI output of the digital set-top box to the **HDMI/DVI IN 1** jack on the TV.
.....
- 2 Connect the audio output of the digital set-top box to the **AUDIO(RGB/DVI)** jack on the TV.
.....
- 3 Turn on the digital set-top box. (Refer to the owner's manual for the digital set-top box.)
.....
- 4 Select **HDMI1** input source using the **INPUT** button on the remote control.

EXTERNAL EQUIPMENT SETUP

DVD SETUP

Connecting with a component cable

- 1 Connect the video outputs (Y, PB, PR) of the DVD to the **COMPONENT IN VIDEO** jacks on the TV.
- 2 Connect the audio outputs of the DVD to the **COMPONENT IN AUDIO** jacks on the TV.
- 3 Turn on the DVD player, insert a DVD.
- 4 Select **Component1** input source using the **INPUT** button on the remote control.
If connected to **COMPONENT IN2**, select **Component2** input source.
- 5 Refer to the DVD player's manual for operating instructions.

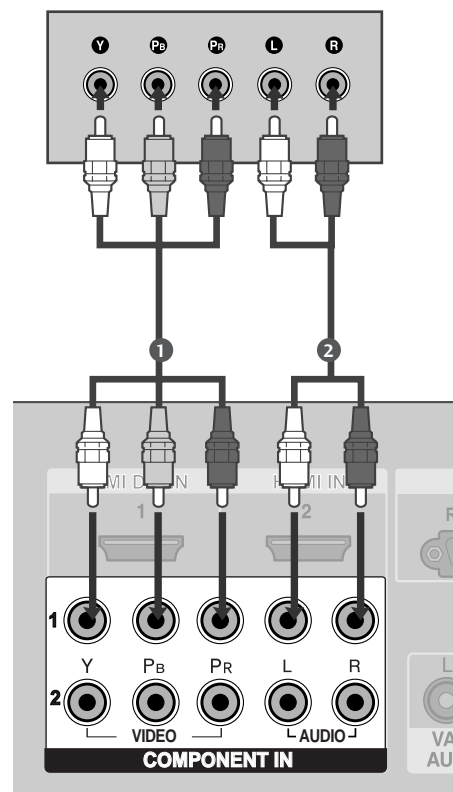

Component Input ports

To achieve better picture quality, connect a DVD player to the component input ports as shown below.

Component ports on the TV	Y	P _B	P _R
Video output ports on DVD player	Y	P _B	P _R
	Y	B-Y	R-Y
	Y	C _b	C _r
	Y	P _b	P _r

Connecting with a RCA cable

- 1 Connect the **AUDIO/VIDEO** jacks between TV and DVD player. Match the jack colours (Video = yellow, Audio Left = white, and Audio Right = red)
- 2 Insert a DVD into the DVD player and press **PLAY** on the DVD player. (Refer to the DVD player owner's manual.)
- 3 Select **AV1** input source using the **INPUT** button on the remote control.
If connected to **AV IN2**, select **AV2** input source.

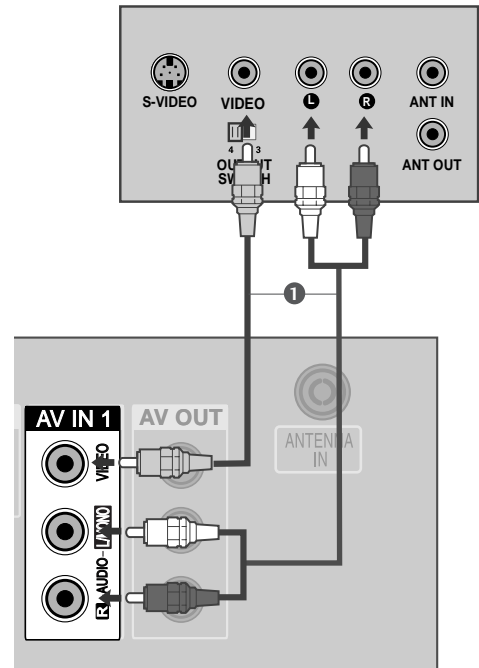

Connecting with a S-Video cable

- 1 Connect the S-VIDEO output of the DVD to the **S-VIDEO** input on the TV.
- 2 Connect the audio outputs of the DVD to the **AUDIO** input jacks on the TV.
- 3 Turn on the DVD player, insert a DVD.
- 4 Select **AV2** input source using the **INPUT** button on the remote control.
- 5 Refer to the DVD player's manual for operating instructions.

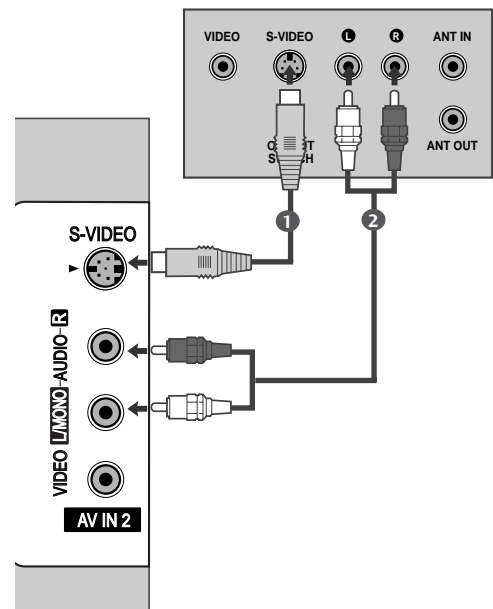

EXTERNAL EQUIPMENT SETUP

Connecting the HDMI cable

- 1 Connect the HDMI output of the DVD to the **HDMI/DVI IN 1** or **HDMI IN 2** jack on the TV.
- 2 Select **HDMI1** or **HDMI2** input source using the **INPUT** button on the remote control.
- 3 Refer to the DVD player's manual for operating instructions.

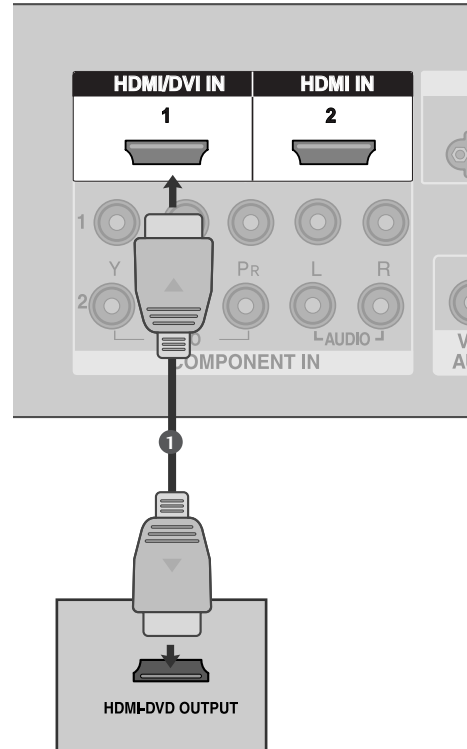

! NOTE

- ▶ The TV can receive video and audio signals simultaneously when using a HDMI cable.
 - ▶ If the DVD player supports Auto HDMI function, the output resolution of the source device will be automatically TV to 1280x720p.
 - ▶ If the DVD player does not support Auto HDMI, you must TV the output resolution appropriately.
- To get the best picture quality, adjust the output resolution of the source device to 1280x720p.

Supported Display Resolution (HDMI-DTV mode)

Resolution	Horizontal Frequency(kHz)	Vertical Frequency(Hz)
720x480	31.47	59.94
	31.50	60.00
720x576	31.25	50.00
1280x720	44.96	59.94
	45.00	60.00
	37.50	50.00
1920x1080i	33.72	59.94
	33.75	60.00
	28.125	50.00
(except VGA Models) 1920x1080p	67.432	59.94
	67.5	60
	56.25	50

VCR SETUP

- To avoid picture noise (interference), allow adequate distance between the VCR and TV.
- Typically a frozen still picture from a VCR. If 4:3 picture format is used for an extended period the fixed images on the sides of the screen may remain visible.

Connecting with a RF cable

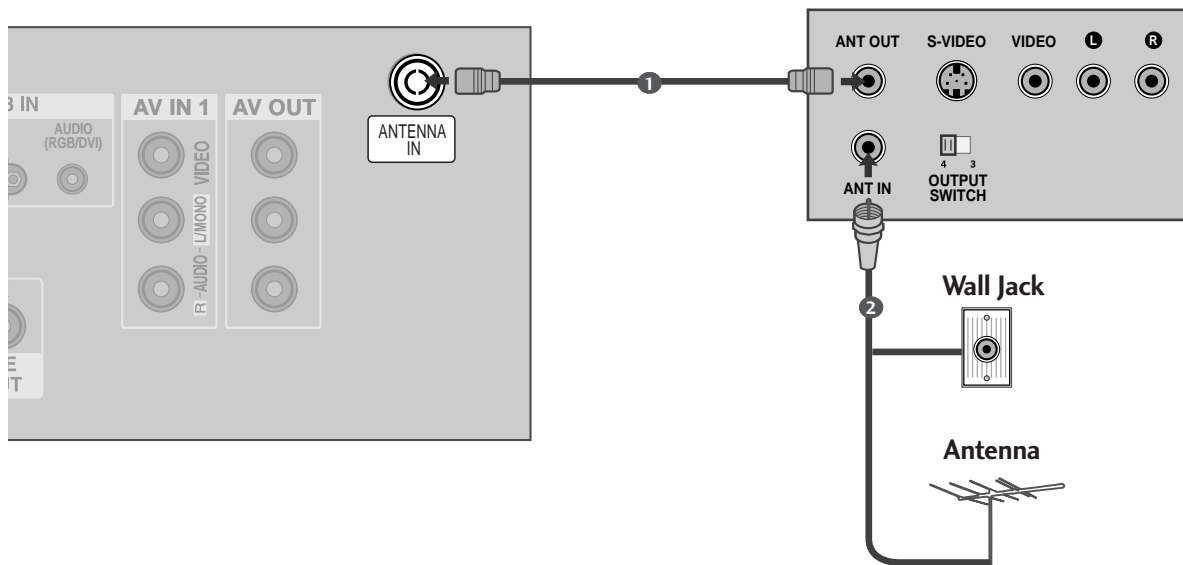

- 1 Connect the **ANT OUT** socket of the VCR to the **ANTENNA IN** socket on the TV.
.....
- 2 Connect the antenna cable to the **ANT IN** socket of the VCR.
.....
- 3 Press the **PLAY** button on the VCR and match the appropriate programme between the TV and VCR for viewing.
.....

EXTERNAL EQUIPMENT SETUP

Connecting with a RCA cable

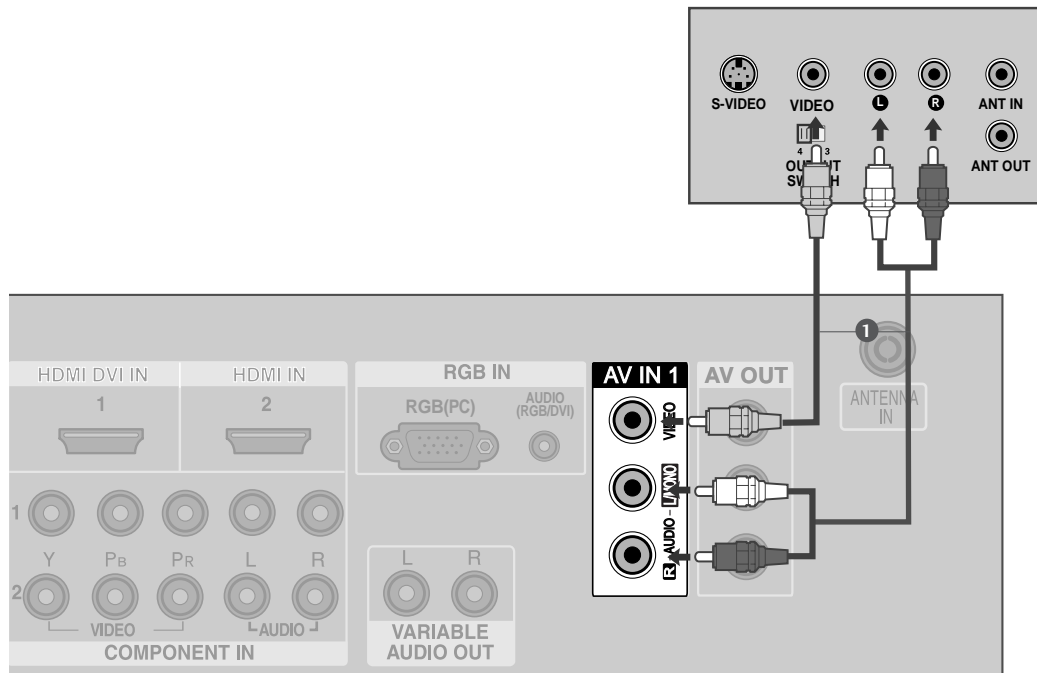

- 1 Connect the **AUDIO/VIDEO** jacks between TV and VCR. Match the jack colours (Video = yellow, Audio Left = white, and Audio Right = red)
- 2 Insert a video tape into the VCR and press PLAY on the VCR. (Refer to the VCR owner's manual.)
- 3 Select **AV1** input source using the **INPUT** button on the remote control.
If connected to **AV IN2**, select **AV2** input source.

! NOTE

- ▶ If you have a mono VCR, connect the audio cable from the VCR to the **AUDIO L/MONO** jack of the TV.

Connecting with a S-Video cable

- 1 Connect the S-VIDEO output of the VCR to the **S-VIDEO** input on the TV. The picture quality is improved; compared to normal composite (RCA cable) input.
- 2 Connect the audio outputs of the VCR to the **AUDIO** input jacks on the TV.
- 3 Insert a video tape into the VCR and press PLAY on the VCR. (Refer to the VCR owner's manual.)
- 4 Select **AV2** input source using the **INPUT** button on the remote control.

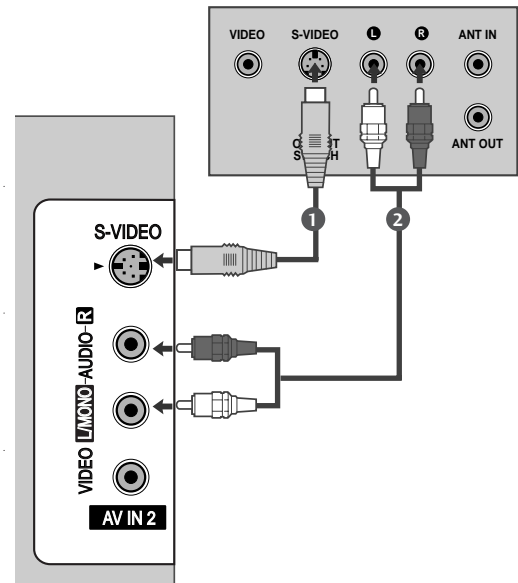

! NOTE

- ▶ If both S-VIDEO and VIDEO sockets have been connected to the S-VHS VCR simultaneously, only the S-VIDEO can be received.

EXTERNAL EQUIPMENT SETUP

OTHER A/V SOURCE SETUP

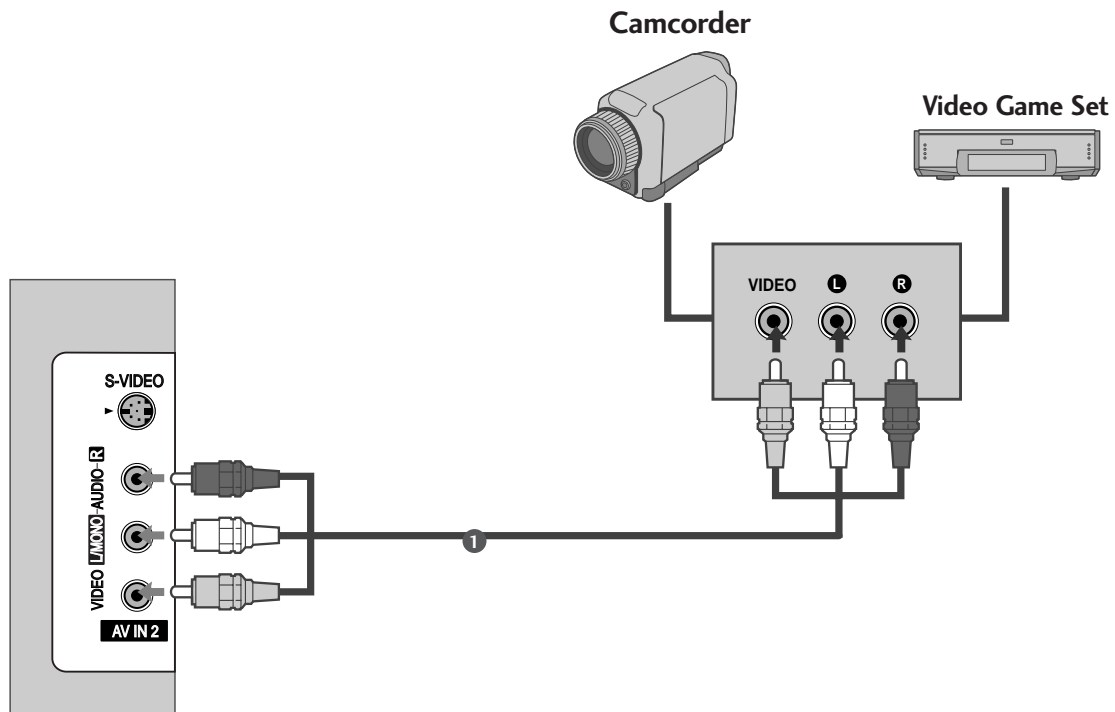

- 1 Connect the **AUDIO/VIDEO** jacks between TV and external equipment. Match the jack colours. (Video = yellow, Audio Left = white, and Audio Right = red)
- 2 Select **AV2** input source using the **INPUT** button on the remote control. If connected to **AV IN1**, select **AV1** input source.
- 3 Operate the corresponding external equipment. Refer to external equipment operating guide.

EXTERNAL STEREO

Use to connected either an external amplifier, or add a sub-woofer to your surround sound system.

- 1 Connect the input jack of the stereo amplifier to the **VARIABLE AUDIO OUT** jacks on the TV.
- 2 Set up your speakers through your analog stereo amplifier, according to the instructions provided with the amplifier.

! NOTE

- ▶ When connecting with external audio equipments, such as amplifiers or speakers, please turn the TV speakers off. (▶ p.65)

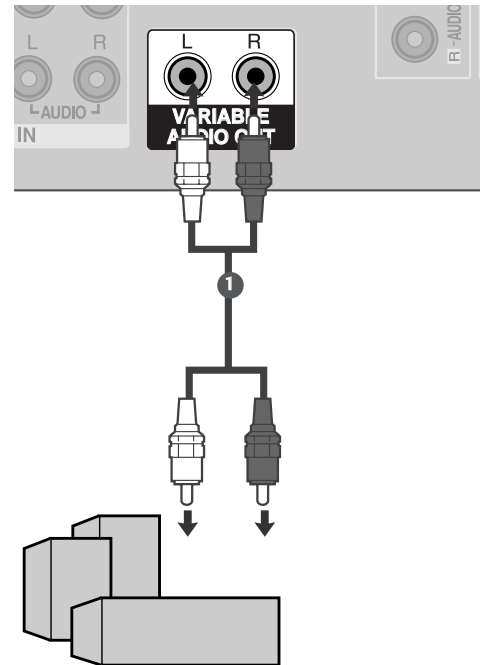

EXTERNAL EQUIPMENT SETUP

PC SETUP

This TV provides Plug and Play capability, meaning that the PC adjusts automatically to the TV's settings.

Connecting with a D-sub 15 pin cable

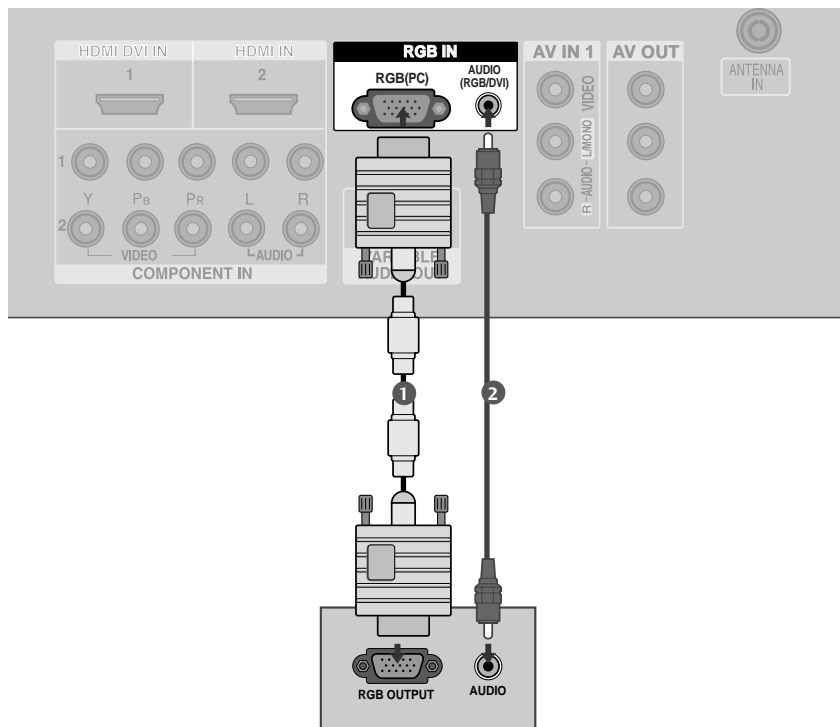

- 1 Connect the RGB output of the PC to the **RGB (PC)** jack on the TV.
.....
- 2 Connect the PC audio output to the **AUDIO** jack on the TV.
.....
- 3 Turn on the PC and the TV.
.....
- 4 Select **RGB PC** input source using the **INPUT** button on the remote control.

! NOTE

- ▶ To enjoy vivid picture and sound, connect the PC to the TV.
- ▶ Avoid keeping a fixed image on the TV's screen for prolonged periods of time. The fixed image may become permanently imprinted on the screen; use a screen saver when possible.
- ▶ Connect the PC to the RGB (PC) port of the TV; change the resolution output of PC accordingly.
- ▶ There may be interference relating to resolution, vertical pattern, contrast or brightness in PC mode. Change the PC mode to another resolution or change the refresh rate to another rate or adjust the brightness and contrast on the menu until the picture is clear. If the refresh rate of the PC graphic card can not be changed, change the PC graphic card or consult the manufacturer of the PC graphic card.
- ▶ The synchronization input waveform for Horizontal and Vertical frequencies are separate.
- ▶ We recommend using 1366x768, 60Hz (LCD TV models) / 852x480, 60Hz (42 inch WVGA PLASMA TV models) / 1024x768, 60Hz (42 inch XGA PLASMA TV models) / 1360x768, 60Hz (50 inch PLASMA TV models) for the PC mode, these should provide the best picture quality.
- ▶ If the resolution of PC is over SXGA, there will be no picture on the TV.
- ▶ Connect the audio cable from the PC to the Audio input on the TV. (Audio cables are not included with the TV).
- ▶ If you use too long an RGB-PC cable, there may be interference on the screen. We recommend using under 5m of the cable. This provides the best picture quality.

Supported Display Resolution (RGB-PC mode)

Resolution	Horizontal Frequency(kHz)	Vertical Frequency(Hz)
640x350	31.5	70.1
720x400	31.5	70.1
640x480	31.5	59.9
848x480	31.5	60.0
852x480	31.5	60.0
800x600	37.9	60.3
1024x768	48.4	60.0
1280x768	47.8	59.9
1360x768	47.7	59.8
1366x768	47.7	59.8

! NOTE

- ▶ It's supported to 848x480, 852x480 in VGA modes. (VGA Models)
- ▶ It's supported to 1280x768, 1360x768, 1366x768 in XGA modes. (XGA Models)

EXTERNAL EQUIPMENT SETUP

Screen Setup for PC mode

Auto Configure (RGB [PC] mode only)

Automatically adjusts picture position and minimizes image instability. After adjustment, if the image is still not correct, your TV is functioning properly but needs further adjustment.

Auto configure

This function is for automatic adjustment of the screen position, clock, and phase. The displayed image will be unstable for a few seconds while the auto configuration is in progress.



1 Press the **MENU** button and then use ▲ / ▼ button to select the **Picture** menu.

2 Press the ► button and then use ▲ / ▼ button to select **Screen**.

3 Press the ► button and then use ▲ / ▼ button to select **Auto Config..**

4 Press the ► button to start **Auto Config..**

- When Auto config. has finished, OK will be shown on screen.
- If the position of the image is still not correct, try Auto adjustment again.

- If picture needs to be adjusted again after Auto adjustment in RGB (PC), you can adjust the **Manual Config..**

5 Press the **EXIT** button to return to TV viewing.

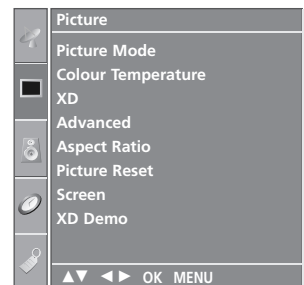

1

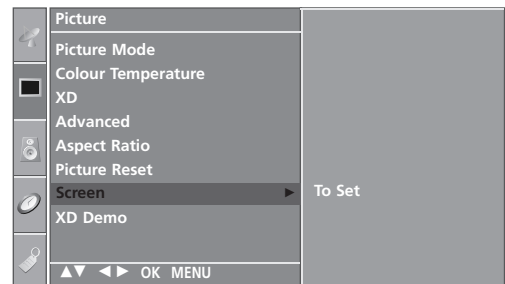

2

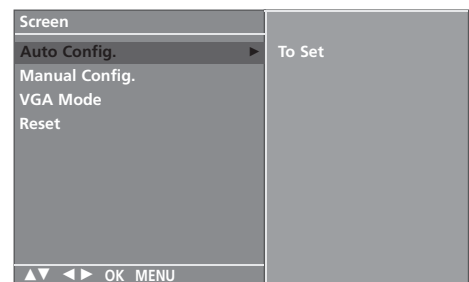

3 4

Adjustment for screen Phase, Clock, Position

If the picture is not clear after auto adjustment and especially if characters are still trembling, adjust the picture phase manually.

To correct the screen size, adjust **Clock**.

This function works in the following mode : RGB[PC], COMPONENT (480i/480p/576i/576p/720p/1080i), HDMI (480p/576p/720p/1080i/1080p(except VGA Models)).

It's not available to use Phase, Clock function in COMPONENT (480i/480p/576i/576p/720p/1080i), HDMI (480p/576p/720p/1080i/1080p(except VGA Models)).

Clock This function is to minimize any vertical bars or stripes visible on the screen background the horizontal screen size will also change.

Phase This function allows you to remove any horizontal noise and clear or sharpen the image of characters.

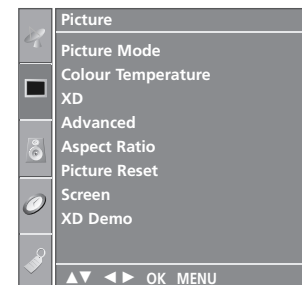

1

- 1 Press the **MENU** button and then use **▲ / ▼** button to select the **Picture** menu.

- 2 Press the **▶** button and then use **▲ / ▼** button to select **Screen**.

- 3 Press the **▶** button and then use **▲ / ▼** button to select **Manual Config.**

- 4 Press the **▶** button and then use **▲ / ▼** button to select **Phase, Clock, H-Position** or **V-Position**.

- 5 Press the **◀ / ▶** button to make appropriate adjustments.

- 6 Press the **EXIT** button to return to TV viewing.

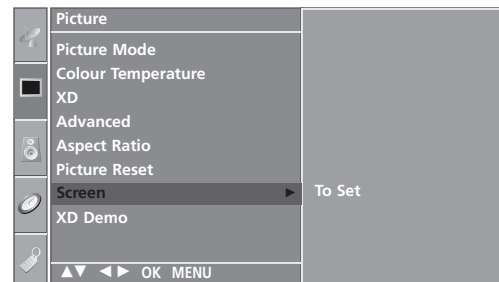

2

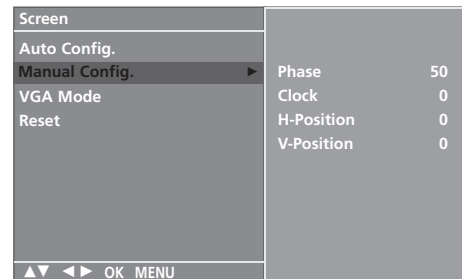

3 4 5

EXTERNAL EQUIPMENT SETUP

Selecting Wide VGA/XGA mode

To view a normal picture, match the resolution of RGB mode and selection of VGA/XGA mode.

This function works in the following mode: RGB[PC] mode.

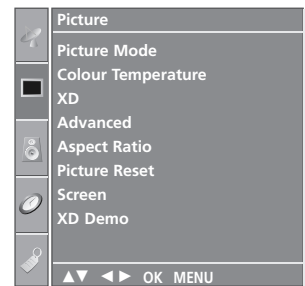

1

1 Press the **MENU** button and then use **▲ / ▼** button to select the **Picture** menu.

2 Press the **▶** button and then use **▲ / ▼** button to select **Screen**.

3 Press the **▶** button and then use **▲ / ▼** button to select **VGA Mode** (or **XGA Mode**).

4 Press the **▶** button and then use **▲ / ▼** button to select the desired VGA/XGA resolution.

5 Press the **EXIT** button to return to TV viewing.

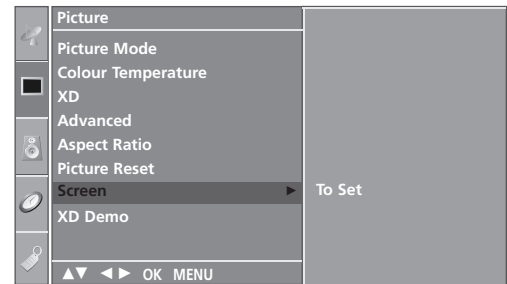

2

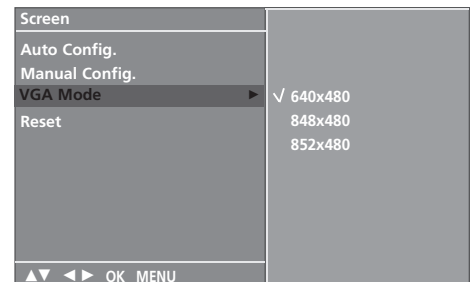

3 4

Initializing (Reset to original factory settings)

This function operates in current mode.
To initialize the adjusted value



- 1 Press the MENU button and then use ▲ / ▼ button to select the **Picture** menu.
- 2 Press the ► button and then use ▲ / ▼ button to select **Screen**.
- 3 Press the ► button and then use ▲ / ▼ button to select **Reset**.
- 4 Press the ► button.
 - You can initialize Position, PIP size, PIP position.
- 5 Press the EXIT button to return to normal TV viewing.

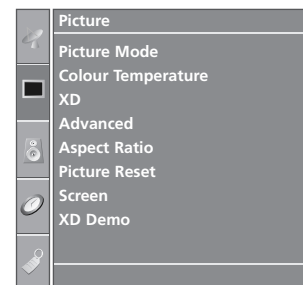

1

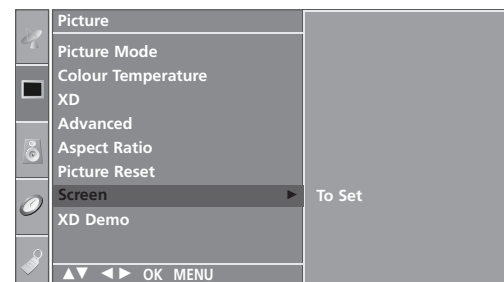

2

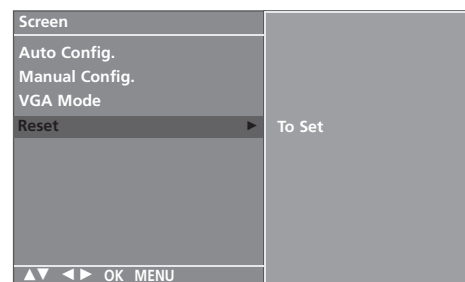

3 4

WATCHING TV / PROGRAMME CONTROL

REMOTE CONTROL KEY FUNCTIONS

When using the remote control, aim it at the remote control sensor on the TV.

POWER Switches the TV on from standby or off to standby.

TV INPUT Returns to the TV viewing from any mode. Switches the TV on from standby.

INPUT If you press the button once, the input source OSD will appear on screen as shown. Press the ▲ / ▼ button and then OK button to select the desired input source (TV, AV1, AV2, Component1, Component2, RGB PC, HDMI1 or HDMI2).

RATIO Selects your desired picture format.

Brightness adjustment Adjusts screen brightness. This returns to the default settings brightness by changing mode source.

1 **PIP** Switches the sub picture PIP mode.

PIP PR - / + Selects a programme for the sub picture.

PIP INPUT Selects the input source for the sub picture in PIP picture mode.

SIZE Adjusts the sub picture size.

POSITION Moves the sub picture.

VCR/DVD control buttons Controls video cassette recorders or DVD players when you select DVD or VCR mode button. Control connected AV devices by pressing the ▲ / ▼ / ◀ / ▶, OK buttons and buttons for play, stop, pause, fast reverse, fast forward, chapter skip. (The ● button does not provide such functions.)

EXIT Clears all on-screen displays and returns to TV viewing from any menu.

LIST Displays the programme table.

MENU Selects a menu.

Q.VIEW Returns to the previously viewed programme.

SLEEP Sets the sleep timer.

1 **SIZE** Adjusts the sub picture size.

1 **POSITION** Moves the sub picture.

1 **INDEX** Moves the sub picture.

1 **REVEAL** Moves the sub picture.

WATCHING TV / PROGRAMME CONTROL



MODE Selects the remote operating modes.

2 TELETEXT BUTTONS These buttons are used for teletext. For further details, see the 'Teletext' section.

SIMPLINK See a list of AV devices connected to TV. When you toggle this button, the Simplink menu appears at the screen. (► p.44)

I/II Selects the sound output.

Coloured buttons These buttons are used for teletext (on **TELETEXT** models) or **Programme edit**.

THUMBSTICK Allows you to navigate the on-screen menus and adjust the system settings to your preference.

OK Accepts your selection or displays the current mode.

VOLUME UP/DOWN Adjusts the volume.

FAV Displays the selected favourite programme.

MUTE Switches the sound on or off.

Programme UP/DOWN Selects a programme.

0~9 number buttons Selects a programme. Selects numbered items in a menu.

Installing Batteries

- Open the battery compartment cover on the back and install the batteries matching correct polarity (+with +,-with -).
- Install two 1.5V AA batteries. Do not mix old or used batteries with new ones.
- Close cover.

WATCHING TV / PROGRAMME CONTROL

TURNING ON THE TV

When your TV is turned on, you will be able to use its features.

- 1 Firstly, connect the power cord correctly.
At this stage, the TV switches to standby mode.
 - In standby mode to turn TV on, press the $\phi/1$, **INPUT**, **PR** \blacktriangle / \blacktriangledown button on the TV or press the **POWER**, **TV**, **INPUT**, **PR** +/-, **NUMBER**(0~9) buttons on the remote control and the TV will switch on.

PROGRAMME SELECTION

- 1 Press the **PR** +/- or **NUMBER** buttons to select a programme number.

VOLUME ADJUSTMENT

- 1 Press the **VOL** +/- button to adjust the volume.
- 2 If you wish to switch the sound off, press the **MUTE** button.
- 3 You can cancel the Mute function by pressing the **MUTE**, **VOL** +/- or **I/II** button.



ON SCREEN MENUS SELECTION AND ADJUSTMENT

Your TV's OSD (On Screen Display) may differ slightly from that shown in this manual.
The OSD mainly use pictures for the Plasma TV models.

- 1 Press the **MENU** button and then **▲ / ▼** button to display each menu.
- 2 Press the **▶** button and then **▲ / ▼** button to select a menu item.
- 3 Change the setting of an item in the sub or pull-down menu with **◀ / ▶** button.
You can move to a higher level menu by pressing the **OK** or **MENU** button.



Setup MENU

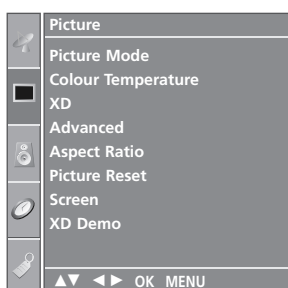

Picture MENU

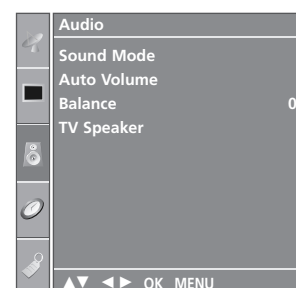

Audio MENU

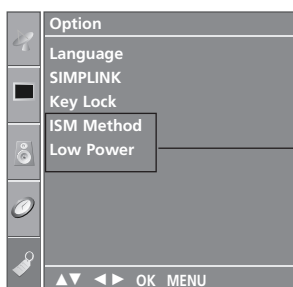

Option MENU

* PLASMA TV models only

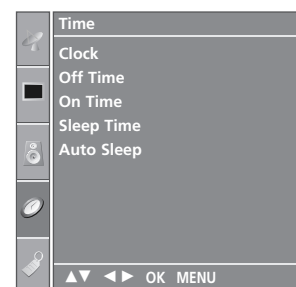

Time MENU

! NOTE

- The OSD (On Screen Display) function enables you to adjust the screen status conveniently since it provides graphical presentation.
- In this manual, the OSD (On Screen Display) may be different from your TV's because it is just example to help the TV operation.
- In the teletext mode, menus are not displayed.

WATCHING TV / PROGRAMME CONTROL

AUTO PROGRAMME TUNING

Up to 100 TV stations can be stored by programme numbers (0 to 99). Once you have preset the stations, you will be able to use the PR +/- or NUMBER buttons to scan the stations you have programmed.

Stations can be tuned using automatic or manual modes.

All stations which can be received are stored by this method. It is recommended that you use Auto tuning during installation of this TV.

1 Press the **MENU** button and then **▲ / ▼** button to select the **Setup** menu.

2 Press the **▶** button and then **▲ / ▼** button to select **Auto Tuning**.

3 Press the **▶** button and then **▲ / ▼** button to select **System**.

4 Press the **▲ / ▼** button to select a TV system menu;
BG: PAL B/G, SECAM B/G (Europe / East Europe / Asia / NewZealand / M.East / Africa / Australia)
I : PAL I/II (U.K. / Ireland / Hong Kong / South Africa)
DK: PAL D/K, SECAM D/K (East Europe / China / Africa / CIS)
M : (USA / Korea / Philippines)

5 Press the **▲ / ▼** button to select **Storage From**.

6 Press the **◀ / ▶** button or NUMBER buttons to select the initial programme number. If you use NUMBER buttons, any number under 10 is entered with a numeric '0' in front of it, i.e. '05' for 5.

7 Press the **▲ / ▼** button to select **Search**.

8 Press the **▶** button to begin auto tuning.
All receivable stations are stored.

To stop auto tuning, press the **MENU** button.

When auto tuning is complete, the Programme edit menu appears on the screen. See the Programme edit section to edit the stored programme.

9 Press the **EXIT** button to return to normal TV viewing.



1

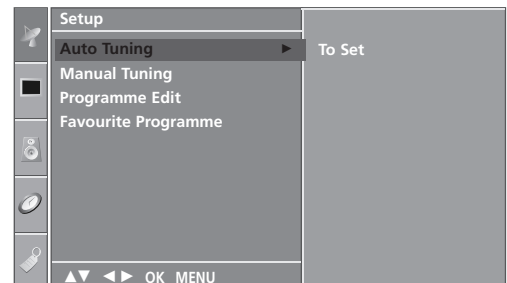

2

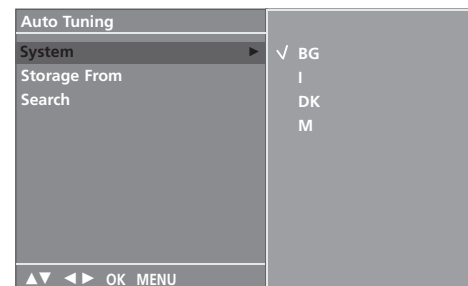

3 4 5 6 7

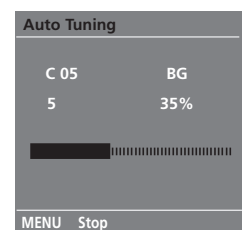

8

MANUAL PROGRAMME TUNING

Manual programme lets you manually tune and arrange the stations in whatever order you desire.

- 1 Press the **MENU** button and then **▲ / ▼** button to select the **Setup** menu.
- 2 Press the **▶** button and then **▲ / ▼** button to select **Manual Tuning**.
- 3 Press the **▶** button and then **▲ / ▼** button to select **Storage**.
- 4 Press the **◀ / ▶** button or NUMBER buttons to select the desired programme number (0 to 99). If you use NUMBER buttons, any number under 10 is entered with a numeric '0' in front of it, i.e. '05' for 5.
- 5 Press the **▲ / ▼** button to select **System**.
- 6 Press the **▲ / ▼** button to select a TV system menu;
 - BG: PAL B/G, SECAM B/G (Europe / East Europe / Asia / NewZealand / M.East / Africa / Australia)
 - I : PAL I/II (U.K. / Ireland / Hong Kong / South Africa)
 - DK: PAL D/K, SECAM D/K (East Europe / China / Africa / CIS)
 - M : (USA / Korea / Philippines)
- 7 Press the **▲ / ▼** button to select **Band**.
- 8 Press the **▶** button and then **▲ / ▼** button to select **V/UHF** or **Cable**.
- 9 Press the **▲ / ▼** button to select **Channel**.
- 10 You can select the desired programme number with the **◀ / ▶** button or NUMBER buttons. If possible, select the programme number directly with the number buttons. Any number under 10 is entered with a numeric '0' in front of it, i.e. '05' for 5.
- 11 Press the **▲ / ▼** button to select **Search**.
- 12 Press the **◀ / ▶** button to commence searching. If a station is found the search will stop.
- 13 Press the **OK** button to store it.
- 14 To store another station, repeat steps 3 to 13.
- 15 Press the **EXIT** button to return to normal TV viewing.



1

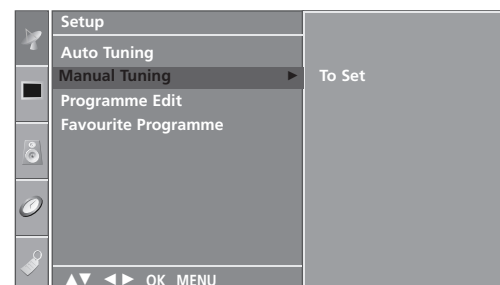

2

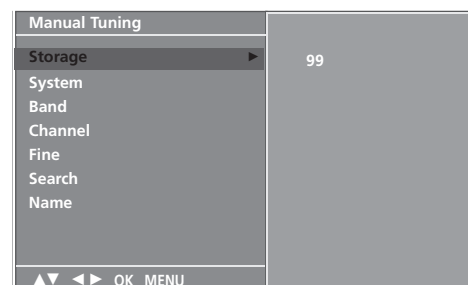

WATCHING TV / PROGRAMME CONTROL

FINE TUNING

Normally fine tuning is only necessary if reception is poor.

- 1 Press the **MENU** button and then **▲ / ▼** button to select the **Setup** menu.
- 2 Press the **▶** button and then **▲ / ▼** button to select **Manual Tuning**.
- 3 Press the **▶** button and then **▲ / ▼** button to select **Fine**.
- 4 Press the **▶** button and then **◀ / ▶** button to fine tune for the best picture and sound.
- 5 Press the **OK** button to store it.
- 6 Press the **EXIT** button to return to normal TV viewing.



1

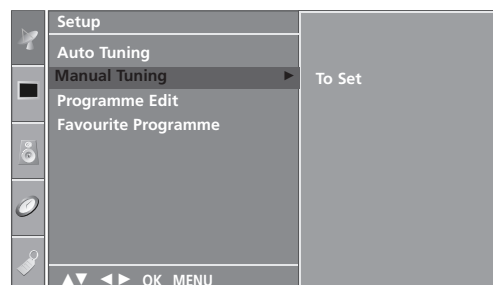

2

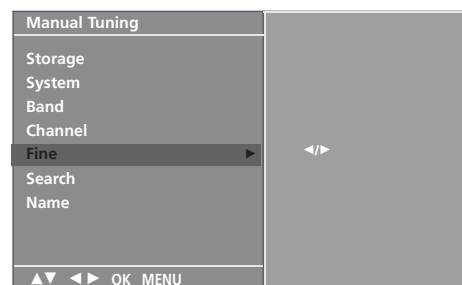

3 4 5

ASSIGNING A STATION NAME

You can assign a station name up to five characters to each programme number.



1 Press the **MENU** button and then **▲ / ▼** button to select the **Setup** menu.

2 Press the **▶** button and then **▲ / ▼** button to select **Manual Tuning**.

3 Press the **▶** button and then **▲ / ▼** button to select **Name**.

4 Press the **▶** button and then **▲ / ▼** button. You can use a blank, **+**, **-**, the number **0** to **9** and the alphabet **A** to **Z**.

5 Press the **◀ / ▶** button to select the position and make your choice of the second character, and so on.

6 Press the **OK** button to store it.

7 Press the **EXIT** button to return to normal TV viewing.



1

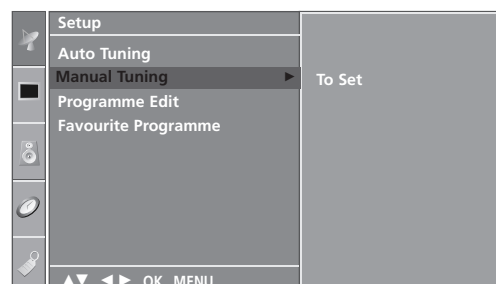

2

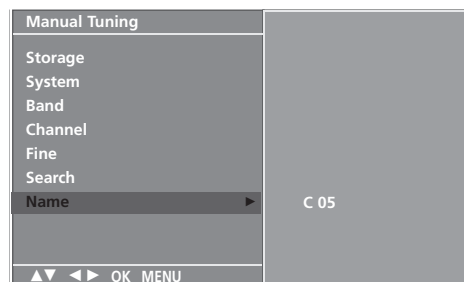

3 4 5 6

WATCHING TV / PROGRAMME CONTROL

PROGRAMME EDIT

This function enables you to delete or skip stored programmes. Also you can move some stations to other programme numbers or copy a blank station data into the selected programme number.

1 Press the **MENU** button and then **▲ / ▼** button to select the **Setup** menu.

2 Press the **▶** button and then **▲ / ▼** button to select **Programme Edit**.

3 Press the **▶** button to display the Programme edit menu.

■ Deleting a programme

1. Select a programme to be deleted with the **▲ / ▼ / ◀ / ▶** button.
2. Press the **RED** button twice.
The selected programme is deleted, all the following programmes are shifted up one position.

■ Copying a programme

1. Select a programme to be copied with the **▲ / ▼ / ◀ / ▶** button.
2. Press the **GREEN** button.
All the following programmes are shifted down one position.

■ Moving a programme

1. Select a programme to be moved with the **▲ / ▼ / ◀ / ▶** button.
2. Press the **YELLOW** button.
3. Move the programme to the desired programme number with the **▲ / ▼ / ◀ / ▶** button.
4. Press the **YELLOW** button again to release this function.

■ Skipping a programme number

1. Select a programme number to be skipped with the **▲ / ▼ / ◀ / ▶** button.
2. Press the **BLUE** button. The skipped programme turns to blue.
3. Press the **BLUE** button again to release the skipped programme.

When a programme number is skipped it means that you will be unable to select it using the **▲ / ▼** button during normal TV viewing. If you wish to select the skipped programme, directly enter the programme number with the **NUMBER** buttons or select it in the programme edit or table menu.

4 Press the **EXIT** button to return to normal TV viewing.



1

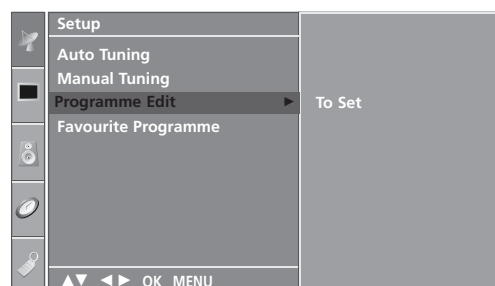

2

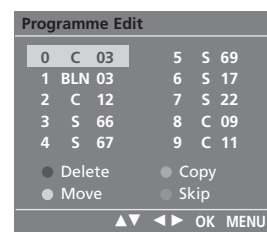

3

FAVOURITE PROGRAMME

This function lets you select your favourite programmes directly.

Repeatedly press the FAV button to select stored favourite programmes.

- 1 Press the **MENU** button and then ▲ / ▼ button to select the **Setup** menu.

- 2 Press the ► button and then ▲ / ▼ button to select **Favourite Programme**.

- 3 Press the ► button.

- 4 Press the ▲ / ▼ button to select - - - - -.

- 5 Select a desired programme with the ◀ / ▶ button or NUMBER buttons. Any number under 10 is entered with a numeric '0' in front of it, i.e. '05' for 5.

- 6 To store another programme, repeat steps 4 to 5. You can store up to 8 programmes.

- 7 Press the **EXIT** button to return to normal TV viewing.



1

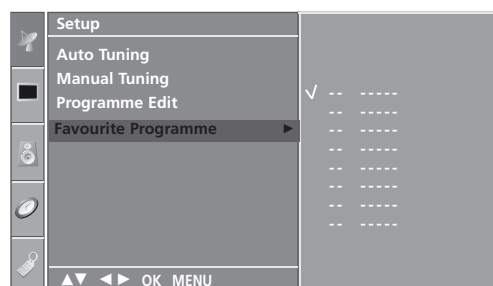

2 3 4 5

WATCHING TV / PROGRAMME CONTROL

SELECTING THE PROGRAMME TABLE

You can check which programmes are stored in the memory by displaying the programme table.

■ Displaying programme table

Press the **LIST** button to display the Programme table menu.

The programme table appears on the screen.

One programme table contains ten programmes as shown.

! NOTE

- You may find some blue programmes. They have been set up to be skipped by auto programming or in the programme edit mode.
- Some programmes with the channel number shown in the programme table indicate there is no station name assigned.

■ Selecting a programme in the programme table

Select a programme with the **▲ / ▼ / ◀ / ▶** button.

Then press the **OK** button. The TV switches to the chosen programme number.

■ Paging through a programme table

There are 10 programme table pages in which contain 100 programmes. Pressing the **▲ / ▼ / ◀ / ▶** button repeatedly turns the pages.

Press the **LIST** button to return to normal TV viewing.



0	C	03	5	S	69
1	BLN	03	6	S	17
2	C	12	7	S	22
3	S	66	8	C	09
4	S	67	9	C	11

KEY LOCK

The TV can be set so that the remote control is needed to control it.

This feature can be used to prevent unauthorized viewing.

This TV is programmed to remember which option it was last set to even if you turn the TV off.

- 1 Press the **MENU** button and then **▲ / ▼** button to select the **Option** menu.
- 2 Press the **▶** button and then **▲ / ▼** button to select **Key Lock**.
- 3 Press the **▶** button and then **▲ / ▼** button to select **On** or **Off**.
- 4 Press the **EXIT** button to return to normal TV viewing.

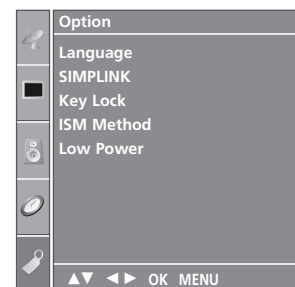

1

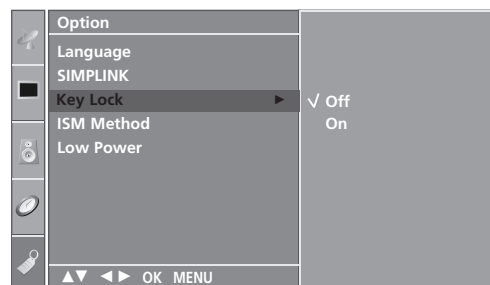

2 3

! NOTE

- ▶ In **Key Lock 'On'**, if the TV is turned off, press the **⏻ / I**, **INPUT**, **PR ▲ / ▼** button on the TV or **POWER**, **INPUT**, **TV**, **PR +/-** or **NUMBER** buttons on the remote control.
- ▶ With the **Key Lock On**, the display **'Key Lock On'** appears on the screen if any button on the front panel is pressed while viewing the TV.

WATCHING TV / PROGRAMME CONTROL



This function operates only with devices with the SIMPLINK logo. Please check the SIMPLINK logo.

This allows you to control and play other AV devices connected to the display through HDMI cable without additional cables and settings.

If you do not require the SIMPLINK menu, select "Off".

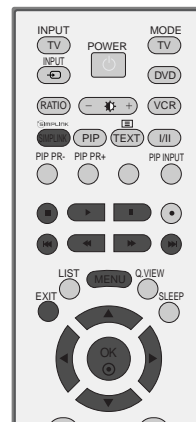

1 Press the **MENU** button and then ▲ / ▼ button to select the **Option** menu.

2 Press the ► button and then ▲ / ▼ button to select **SIMPLINK**.

3 Press the ► button and then ▲ / ▼ button to select **On** or **Off**.

4 Press the **EXIT** button to return to normal TV viewing.

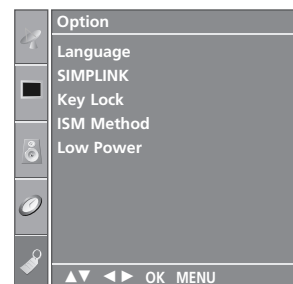

1

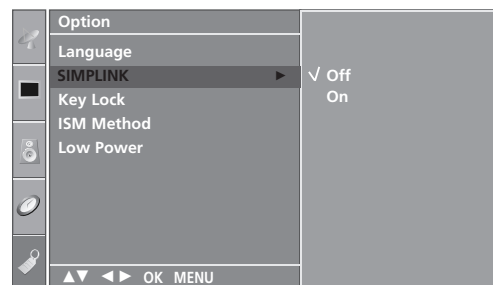

2 3

SIMPLINK Functions

Disc playback

Control connected AV devices by pressing the ▲ / ▼ / ◀ / ▶, OK buttons and buttons for play, stop, pause, fast reverse, fast forward, chapter skip. (The ⏻ button does not provide such functions)

Direct Play

After connecting AV devices to the TV, you can directly control the devices and play media without additional settings.

Select AV device

Enables you to select one of the AV devices connected to the TV and operate it.

Power off all devices

When you switch off the TV, all connected devices are turned off.

Switch audio-out

Offers an easy way to switch audio-out.

* A device, which is connected to the TV through a HDMI cable but does not support SIMPLINK, does not provide this function.

SIMPLINK Menu

Press the ▲ / ▼ / ◀ / ▶ button and then OK button to select the desired SIMPLINK source.

- 1 **TV viewing** : Switch to the previous TV programme regardless of the current mode.
- 2 **DISC playback** : Select and play discs. When multiple discs are available, the titles of the discs are conveniently displayed at the bottom of the screen.
- 3 **VCR playback** : Control the connected VCR.
- 4 **HDD Recordings playback** : Control recordings stored in HDD.
- 5 **Audio Out to Home theater/Audio Out to TV** : Select Home theater or TV speaker for Audio Out.

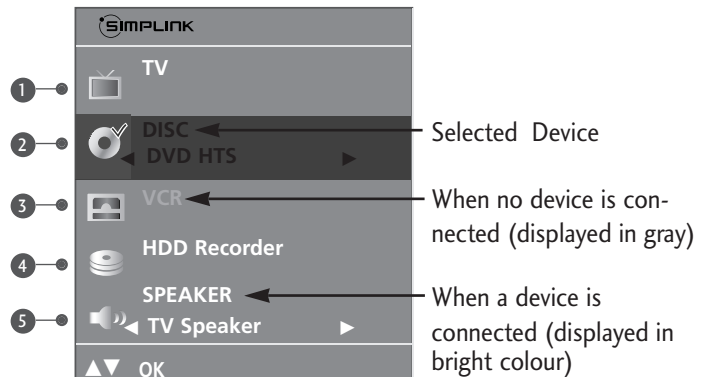

! NOTE

- ▶ Connect the HDMI/DVI IN or HDMI IN terminal of the TV to the rear terminal (HDMI terminal) of the SIMPLINK device with the HDMI cable.
- ▶ After connecting the HDMI terminal for the home theatre with SIMPLINK function using the above method, connect the VARIABLE AUDIO OUT terminal on the back of the TV to the VARIABLE AUDIO IN terminal on the back of the SIMPLINK device with the VARIABLE AUDIO OUT cable.
- ▶ When operating an external device with SIMPLINK, press the TV button from the MODE button on the remote control.
- ▶ When you switch the Input source using the INPUT button on the remote control, you can stop the operation of a device controlled by SIMPLINK.
- ▶ When you select or operate a media device with home theatre function, the speaker automatically switches to home theatre speaker (HT speaker).

PICTURE CONTROL

WATCHING PIP(PICTURE-IN-PICTURE)

PIP lets you view 2 different inputs (sources) on your TV screen at the same time. One source will be large, and the other source will show a smaller inset image.

PIP function is available in the Component, RGB, HDMI mode. (But, it can't adjust 480i/576i resolution of Component mode.)

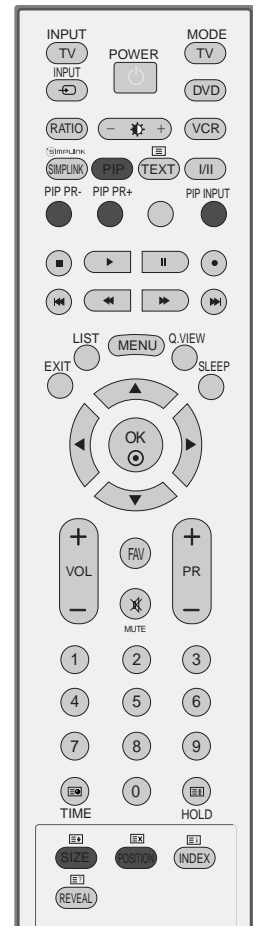

Watching PIP/Double Window

Press the **PIP** button to access the sub picture.
Each press of PIP changes the PIP options.

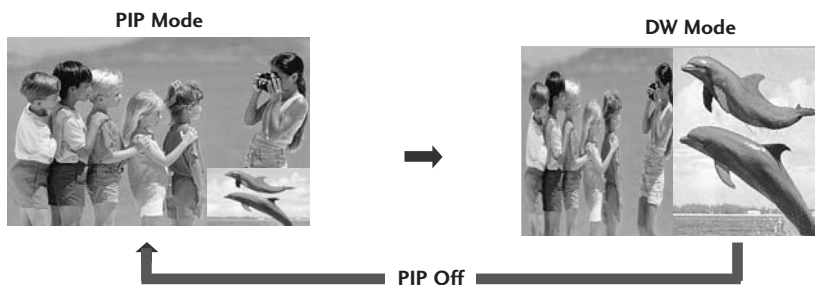

Programme Selection for Sub Picture

Press the PIP PR +/- button to select a programme for the sub picture.

The selected programme number is displayed just below the programme number of main picture.

Input Source Selection for Sub Picture

Press the **PIP INPUT** button to select the input source for the sub picture.
Each press of **PIP INPUT** button is pressed, each input source for the sub picture is displayed.
(Sub picture can be selected only TV, AV1, AV2)

Sub Picture Size Adjustment (PIP mode only)

Press the **SIZE** button to adjust the sub picture size.
With **SIZE** button in PIP mode, sub picture is adjusted.

Moving the Sub Picture (PIP mode only)

Press the **POSITION** button.
Repeatedly press the **POSITION** button then sub picture moves.

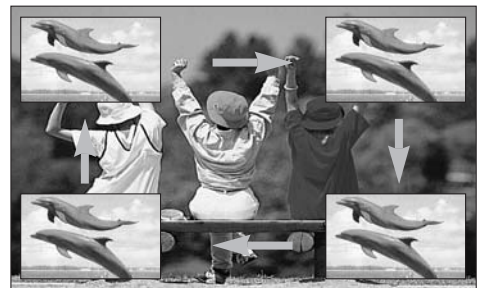

PICTURE CONTROL

PICTURE SIZE (ASPECT RATIO)CONTROL

You can watch the screen in various picture formats; **Spectacle**, **Original**, **4:3**, **16:9**, **14:9** and **Zoom1/2**.

If a fixed image is displayed on the screen for a long time, that fixed image may become imprinted on the screen and remain visible.

You can adjust the enlarge proportion using ▲ / ▼ button.

This function works in the following signal.

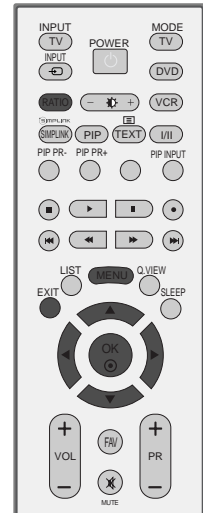

- 1 Press the **RATIO** button repeatedly to select the desired picture format. You can also adjust **Aspect Ratio** in the **Picture** menu.

• Spectacle

When your TV receives the wide screen signal, when selected it will adjust the picture horizontally, in non-linear proportion, to fill the entire screen.

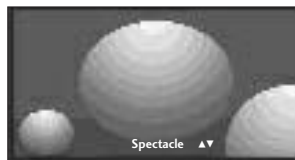

• Original

When your TV receives a wide screen signal it will automatically change to the picture format to be broadcast.

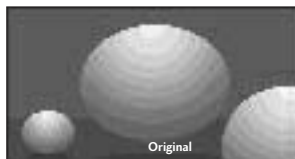

• 4:3

The following selection will allow you to view a picture with an original 4:3 aspect ration, grey bars will appear on both the left and right hand of the screen.



• 16:9

The following selection will allow you to adjust the picture horizontally, in linear proportion, to fill the entire screen (useful for viewing 4:3 formatted DVDs).

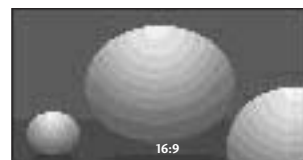

• **14:9**

You can view a picture format of 14:9 or a general TV programme in the 14:9 mode. The 14:9 screen is viewed in the same way as in 4:3, but is magnified to the left and right.

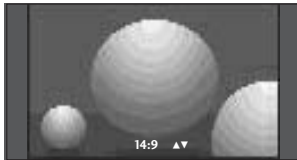

• **Zoom1**

The following selection will allow you to view the picture without any alteration, while filling the entire screen. However, the top and bottom of the picture will be cropped.

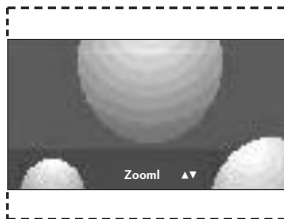

• **Zoom2**

Choose Zoom 2 when you wish the picture to be altered, both horizontally extended and vertically cropped. The picture adopting a compromise between alteration and screen coverage.

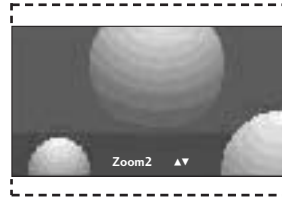

! NOTE

► You can only select **4:3, 16:9 (Wide)** in Component, RGB, HDMI mode only.

PICTURE CONTROL

PRESET PICTURE SETTINGS

Picture Mode-Preset

- Cable** Select this option to optimize the image about the external video device. (It's not available for all models.)
- Intelligent Eye** Adjusts picture according to the surrounding conditions. (32/42LB9R* only)
- Dynamic** Select this option to display a sharp image.
- Standard** The most general and natural screen display status.
- Mild** Select this option to display a mild image.
- User1/2** Selection this option to use a user defined setting.



1 Press the **MENU** button and then **▲ / ▼** button to select the **Picture** menu.

2 Press the **▶** button and then **▲ / ▼** button to select **Picture Mode**.

3 Press the **▶** button and then **▲ / ▼** button to select **Cable (It's not available for all models.)**, **Intelligent Eye (32/42LB9R* only)**, **Dynamic**, **Standard**, **Mild**, **User1** or **User2**.

4 Press the **EXIT** button to return to normal TV viewing.

- Picture Mode adjusts the TV for the best picture appearance. Select the preset value in the **Picture Mode** menu based on the programme category.
- Cable (It's not available for all models.), Intelligent Eye (32/42LB9R* only), Dynamic, Standard and Mild are programmed for optimum picture reproduction at the factory and cannot be changed.
- When the Intelligent eye function is on, the most suitable picture is automatically adjusted according to the surrounding conditions. (32/42LB9R* only)

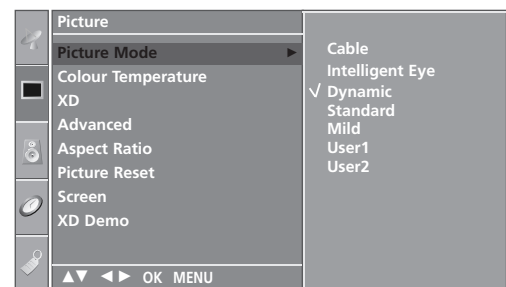
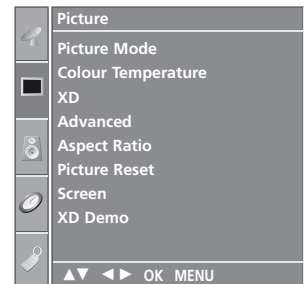

NOTE

- ▶ Cable is available to use this function in AV mode.
- ▶ Cable is not available for all models.

Auto Colour Tone Control(Warm/Medium/Cool)

To initialize values (reset to default settings), select the Cool option.

Choose one of three automatic colour adjustments. Set to warm to enhance hotter colours such as red, or set to cool to see less intense colours with more blue.

This menu is activated after selecting "User1" or "User2" in the Picture Mode.

- 1 Press the **MENU** button and then **▲ / ▼** button to select the **Picture** menu.
- 2 Press the **▶** button and then **▲ / ▼** button to select **Colour Temperature**.
- 3 Press the **▶** button and then **▲ / ▼** button to select either **Cool**, **Medium**, **Warm** or **User**.
- 4 Press the **EXIT** button to return to normal TV viewing.

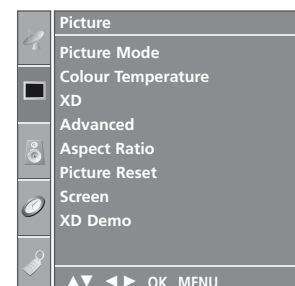

1

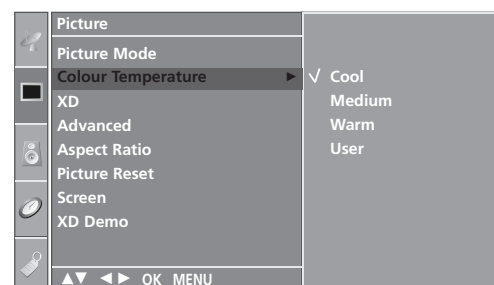

2 3

PICTURE CONTROL

MANUAL PICTURE ADJUSTMENT

Picture Mode-User Option

- Contrast** Adjusts the difference between light and dark levels in the picture.
- Brightness** Increases or decreases the amount of white in the picture.
- Colour** Adjusts intensity of all colours.
- Sharpness** Adjusts the level of crispness in the edges between the light and dark areas of the picture. The lower the level, the softer the image.
- Tint** Adjusts the balance between red and green levels.



- 1 Press the **MENU** button and then **▲ / ▼** button to select the **Picture** menu.
- 2 Press the **▶** button and then **▲ / ▼** button to select **Picture Mode**.
- 3 Press the **▶** button and then **▲ / ▼** button to select **User1** or **User2**.
- 4 Press the **▶** button and then **▲ / ▼** button to select the desired picture option (**Contrast**, **Brightness**, **Colour**, **Sharpness** and **Tint**).
- 5 Press the **◀ / ▶** button to make appropriate adjustments.
- 6 Press the **EXIT** button to return to normal TV viewing.

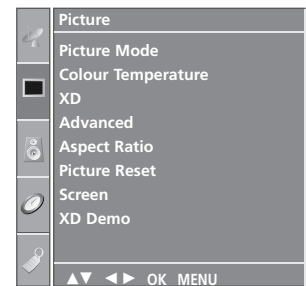

1

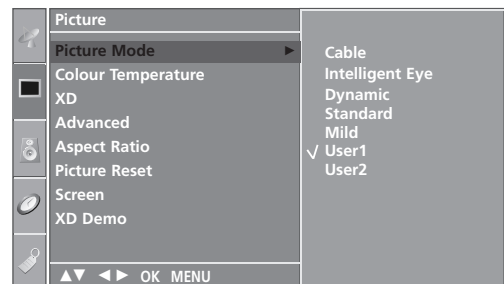

2 3

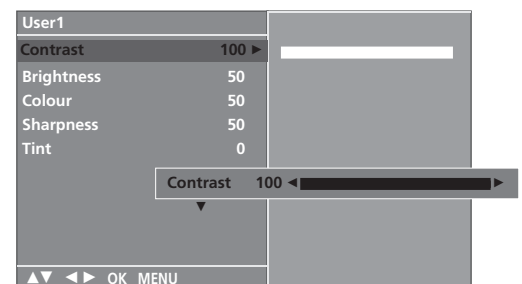

4 5

! NOTE

- ▶ You cannot adjust colour, sharpness and tint in the RGB-PC mode.

Colour Tone - User Option

To adjust red, green, blue to any colour temperature you prefer.

This menu is activated after selecting “User1” or “User2” in the Picture Mode.

- 1 Press the **MENU** button and then **▲ / ▼** button to select the **Picture** menu.

- 2 Press the **▶** button and then **▲ / ▼** button to select **Colour Temperature**.

- 3 Press the **▶** button and then **▲ / ▼** button to select **User**.

- 4 Press the **▶** button and then **▲ / ▼** button to select **Red**, **Green** or **Blue**.

- 5 Press the **◀ / ▶** button to make appropriate adjustments.

- 6 Press the **EXIT** button to return to normal TV viewing.

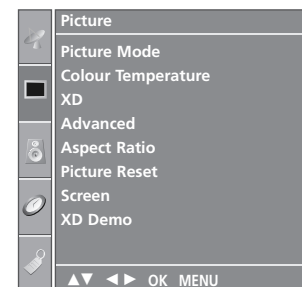

1

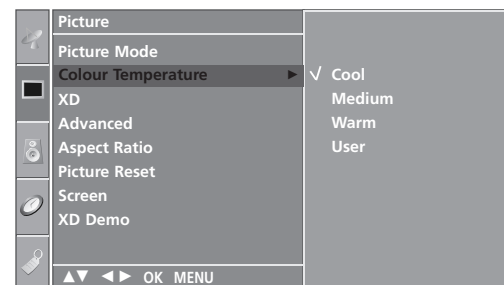

2 3

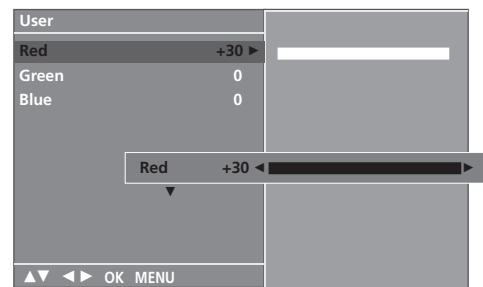

4 5

PICTURE CONTROL

XD - PICTURE IMPROVEMENT TECHNOLOGY

XD is LG electronic's unique picture improving technology to display a real HD source through an advanced digital signal processing algorithm.

It is not possible to use this function in RGB-PC mode.

- 1 Press the MENU button and then ▲ / ▼ button to select the **Picture** menu.
- 2 Press the ► button and then ▲ / ▼ button to select **XD**.
- 3 Press the ► button and then ▲ / ▼ button to select **Auto** or **Manual**.
- 4 Press the EXIT button to return to TV viewing.

* Manual Selection

This menu is activated after selecting the **User1** or **User2** of **Picture Mode**.

- 1 Press the ► button and then ▲ / ▼ button to select **XD Contrast**, **XD Colour** or **XD NR**.
- 2 Press the ► button and then ▲ / ▼ button to select **On** or **Off**.
- 3 Press the EXIT button to return to normal TV viewing.

- **XD Contrast** : Optimises the contract automatically according to the brightness of the reflection.
- **XD Colour** : Adjusts the colour of the reflection automatically to reproduce as close as possible to natural colours.
- **XD NR** : Removes interference up to the point where it does not damage the original picture. (It is not possible to use this function in HDMI, Component (except 480i/576i), RGB-PC mode.)

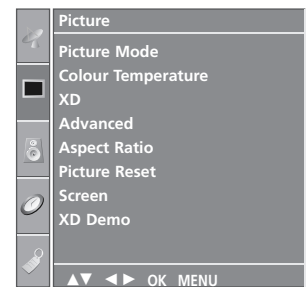

1

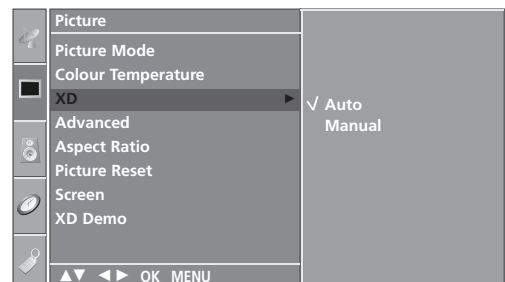

2 3

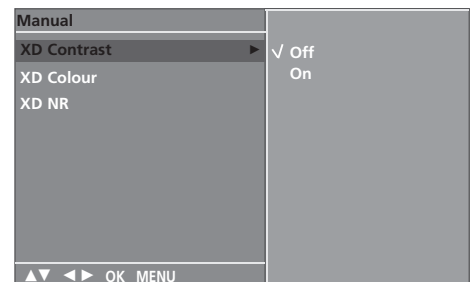

1 2

XD DEMO

Use it to see the difference between XD Demo on and XD Demo off.

It is not possible to use this function in RGB[PC] mode.



- 1 Press the MENU button and then ▲ / ▼ button to select the **Picture** menu.
- 2 Press the ► button and then ▲ / ▼ button to select **XD Demo**.
- 3 Press the ► button to begin **XD Demo**.
- 4 To stop **XD Demo**, press the MENU button.

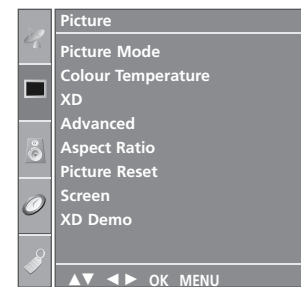

1

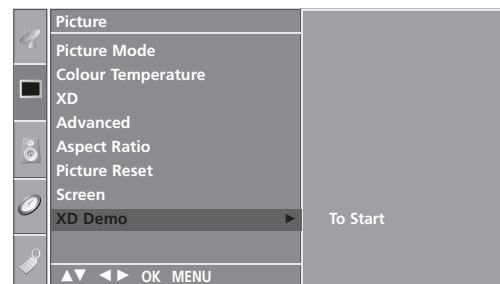

2 3

• XD Demo



PICTURE CONTROL

ADVANCED - CINEMA

To set the TV up for the best picture quality for viewing films.

This feature operates only in Analog TV, AV, S-video and Component 480i/576i mode.



1 Press the **MENU** button and then **▲ / ▼** button to select the **Picture** menu.

2 Press the **▶** button and then **▲ / ▼** button to select **Advanced**.

3 Press the **▶** button and then **▲ / ▼** button to select **Cinema**.

4 Press the **▶** button and then **▲ / ▼** button to select **On** or **Off**.

5 Press the **EXIT** button to return to normal TV viewing.

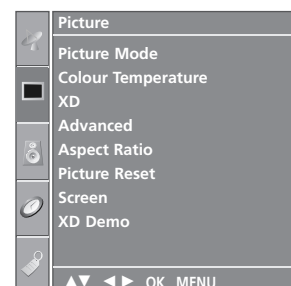

1

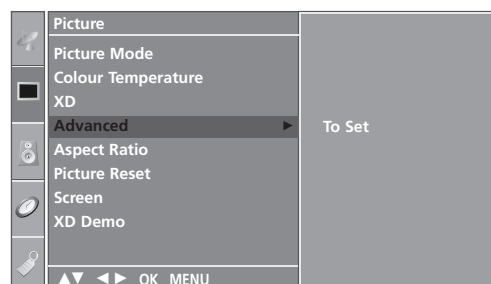

2 3

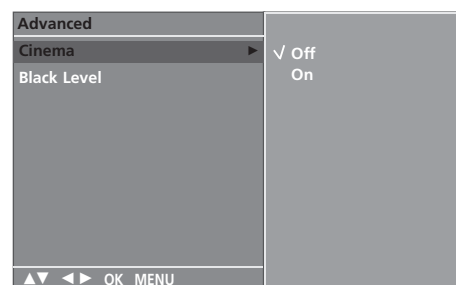

4

ADVANCED - BLACK(DARKNESS) LEVEL

When you view a film this function adjust the TV to best picture quality. Adjusting the contrast and the brightness of the screen using the black level of the screen.

This function works in the following mode: AV (NTSC-M), S-Video (NTSC-M) or HDMI.



1 Press the **MENU** button and then **▲ / ▼** button to select the **Picture** menu.

2 Press the **▶** button and then **▲ / ▼** button to select **Advanced**.

3 Press the **▶** button and then **▲ / ▼** button to select **Black Level**.

4 Press the **▶** button and then **▲ / ▼** button to select **Low** or **High**.

- **Low** : The reflection of the screen gets darker.
- **High** : The reflection of the screen gets brighter.

5 Press the **EXIT** button to return to normal TV viewing.

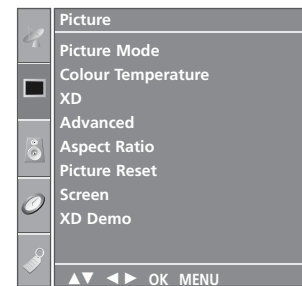

1

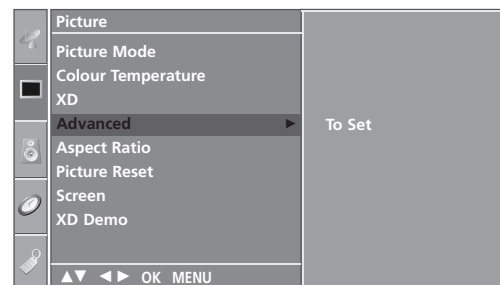

2 3

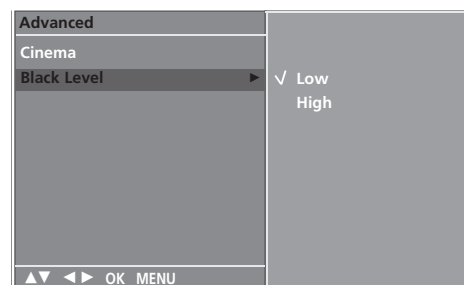

4

PICTURE CONTROL

PICTURE RESET

Returns to the default factory setting for Picture Mode, Colour Temperature, XD, Advanced, Aspect Ratio.



1 Press the **MENU** button and then ▲ / ▼ button to select the **Picture** menu.

2 Press the ► button and then ▲ / ▼ button to select **Picture Reset**.

3 Press the ► button to initialize the adjusted value.

4 Press the **EXIT** button to return to normal TV viewing.

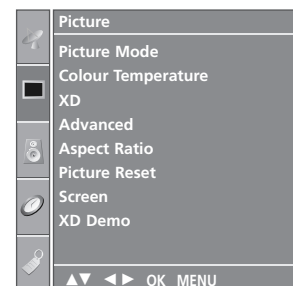

1

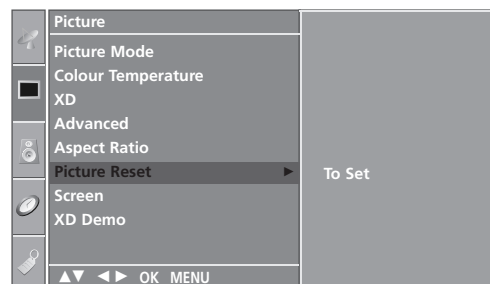

2 3

IMAGE STICKING MINIMIZATION(ISM)METHOD

A frozen or still picture from a PC/Video game displayed on the screen for prolonged periods will result in a ghost image remaining even when you change the image. Avoid allowing a fixed image to remain on the screen for prolonged periods.

It is not possible to use this function in LCD models.

White Wash

White wash removes permanent images from the screen.

Note: An excessive permanent image may be impossible to clear entirely with White Wash.

Orbiter

Orbiter may help prevent ghost images. However, it is best not to allow any fixed image to remain on the screen. To avoid a permanent image on the screen, the screen will move every 2 minutes.

Inversion

This function inverts the panel colour of the screen. The panel colour is automatically inverted every 30 minutes.

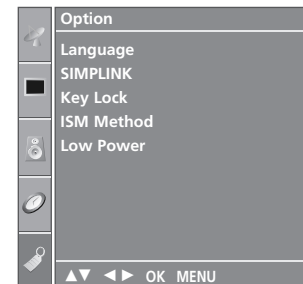

1 Press the **MENU** button and then **▲ / ▼** button to select the **Option** menu.

2 Press the **▶** button and then **▲ / ▼** button to select **ISM Method**.

3 Press the **▶** button and then **▲ / ▼** button to select either **Normal**, **White Wash**, **Orbiter** or **Inversion**. If you do not need this function, set **Normal**.

4 Press the **EXIT** button to return to normal TV viewing.

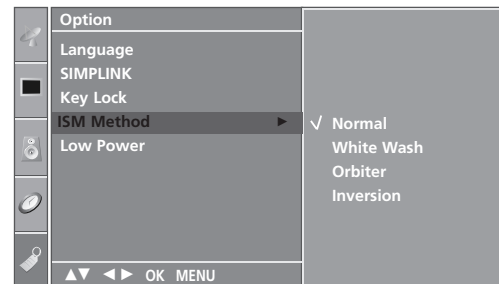

PICTURE CONTROL

LOW-POWER PICTURE MODE

This function allows you to reduce the power consumption of the TV.

It is not possible to use this function in LCD models.

- 1 Press the **MENU** button and then **▲ / ▼** button to select the **Option** menu.
- 2 Press the **▶** button and then **▲ / ▼** button to select **Low Power**.
- 3 Press the **▶** button and then **▲ / ▼** button to select **On** or **Off**.
- 4 Press the **EXIT** button to return to normal TV viewing.

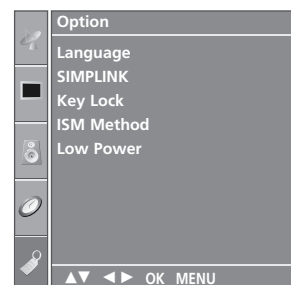

1

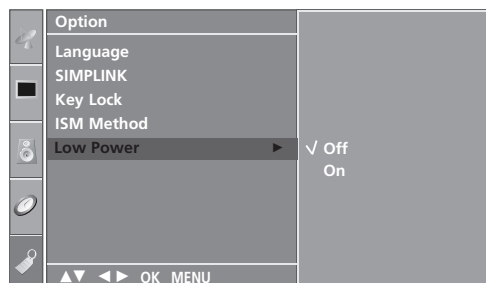

2 3

SOUND & LANGUAGE CONTROL

AUTO VOLUME LEVELER

Auto Volume automatically remains on the same level of volume if you change programmes.



- 1 Press the **MENU** button and then **▲** / **▼** button to select the **Audio** menu.
- 2 Press the **▶** button and then **▲** / **▼** button to select **Auto Volume**.
- 3 Press the **▶** button and then **▲** / **▼** button to select **On** or **Off**.
- 4 Press the **EXIT** button to return to normal TV viewing.

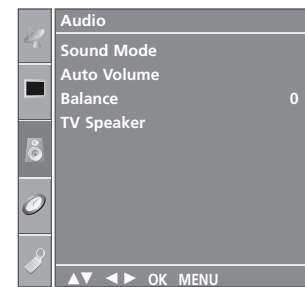

1

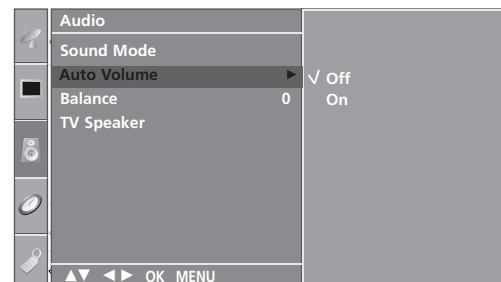

2 3

SOUND & LANGUAGE CONTROL

PRESET SOUND SETTINGS-SOUND MODE

You can select your preferred sound setting; Surround MAX, Standard, Music, Movie or Sports and you can also adjust the frequency of the equalizer.

Sound Mode lets you enjoy the best sound without any Special adjustment as the TV sets the appropriate sound options based on the programme content.

Surround MAX, Standard, Music, Movie, and Sports are preset for optimum sound quality at the factory and are not adjustable.

Surround MAX Select this option for the most realistic sound.

Standard Commanding and natural audio.

Music Select this option to enjoy the original sound when listening to music.

Movie Select this option to enjoy sublime sound.

Sports Select this option to watch sports broadcasting.

User Select this option for user-defined audio settings.

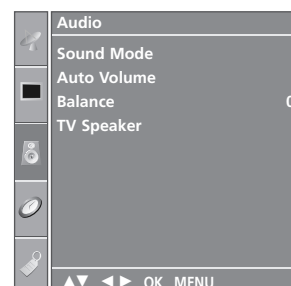

1

1 Press the **MENU** button and then **▲ / ▼** button to select the **Audio** menu.

2 Press the **▶** button and then **▲ / ▼** button to select **Sound Mode**.

3 Press the **▶** button and then **▲ / ▼** button to select **Surround MAX, Standard, Music, Movie, Sports** or **User**.

4 Press the **EXIT** button to return to normal TV viewing.

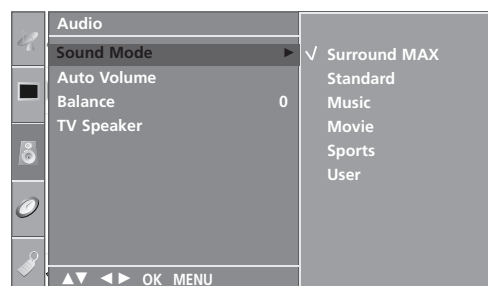

2 3

SOUND SETTING ADJUSTMENT -USER MODE

Adjusting the audio equalizer.

- 1 Press the **MENU** button and then **▲ / ▼** button to select the **Audio** menu.
- 2 Press the **▶** button and then **▲ / ▼** button to select **Sound Mode**.
- 3 Press the **▶** button and then **▲ / ▼** button to select **User**.
- 4 Press the **▶** button.
- 5 Select a frequency band by pressing the **◀ / ▶** button. Set the desired sound level with the **▲ / ▼** button.
- 6 Press the **EXIT** button to return to normal TV viewing.

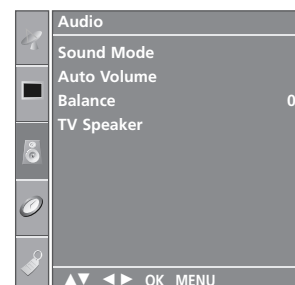

1

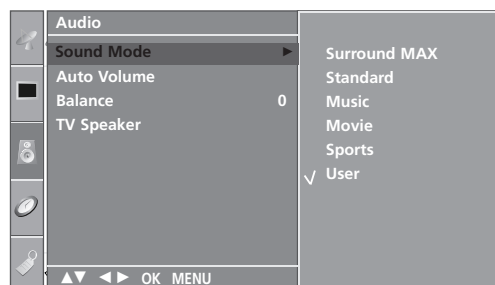

2 3 4

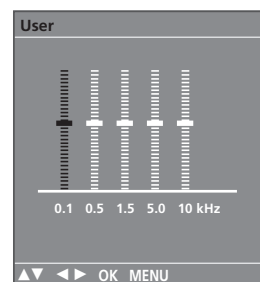

5

SOUND & LANGUAGE CONTROL

BALANCE

You can adjust the sound balance of the speakers to the preferred levels.



1 Press the **MENU** button and then ▲ / ▼ button to select the **Audio** menu.

2 Press the ► button and then ▲ / ▼ button to select **Balance**.

3 Press the ► button and then ◀ / ▶ button to make desired adjustment.

4 Press the **EXIT** button to return to normal TV viewing.

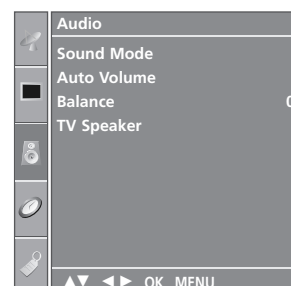

1

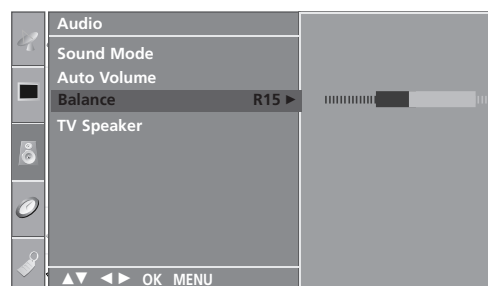

2 3

TV SPEAKERS ON/OFF SETUP

You can adjust the internal speaker status.

In AV, COMPONENT, RGB[PC] and HDMI mode, internal speaker audio can be operational even when there is no video signal.

If you wish to use an external hi-fi system, turn off the TV internal speakers.



- 1 Press the **MENU** button and then **▲ / ▼** button to select the **Audio** menu.
- 2 Press the **▶** button and then **▲ / ▼** button to select **TV Speaker**.
- 3 Press the **▶** button and then **▲ / ▼** button to select **On** or **Off**.
- 4 Press the **EXIT** button to return to normal TV viewing.

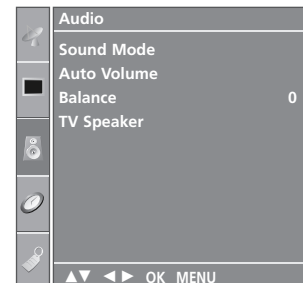

1

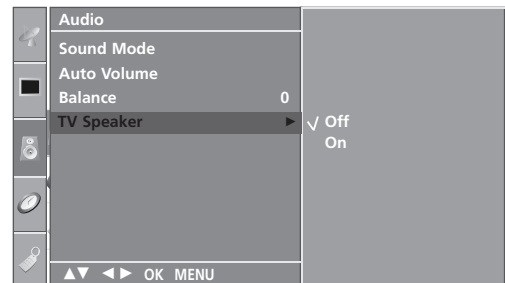

2 3

SOUND & LANGUAGE CONTROL

I/II

Stereo/Dual Reception

When a programme is selected, the sound information for the station appears after the programme number and station name disappear.

Broadcast	On Screen Display
Mono	MONO
Stereo	STEREO
Dual	DUAL I

■ Mono sound selection

If the stereo signal is weak in stereo reception, you can switch to mono by pressing the I/II button twice. In mono reception, the clarity of sound is improved. To switch back to stereo, press the I/II button twice.

■ Language selection for dual language broadcast

If a programme can be received in two languages (dual language), you can switch to DUAL I, DUAL II or DUAL I+II by pressing the I/II button repeatedly.

- DUAL I** Sends the primary broadcast language to the loudspeakers.
- DUAL II** Sends the secondary broadcast language to the loudspeakers.
- DUAL I+II** Sends a separate language to each loudspeaker.

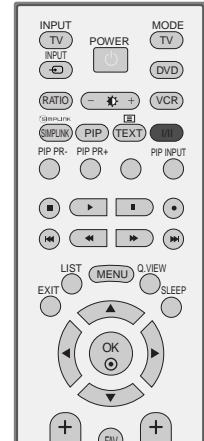

NICAM Reception

If the TV is equipped with a receiver for NICAM reception, high quality NICAM (Near Instantaneous Companding Audio Multiplex) digital sound can be received.

Sound output can be selected according to the type of broadcast received by pressing the I/II button repeatedly.

-
- 1 When **NICAM mono** is received, you can select **NICAM MONO** or **FM MONO**.
-
- 2 When **NICAM stereo** is received, you can select **NICAM STEREO** or **FM MONO**.
If the stereo signal is weak, switch to **FM MONO**.
-
- 3 When **NICAM dual** is received, you can select **NICAM DUAL I**, **NICAM DUAL II** or **NICAM DUAL I+II** or **MONO**.
-

Speaker Sound Output Selection

In AV, S-Video, Component, RGB and HDMI mode, you can select output sound for the left and right loudspeakers.

Repeatedly press the I/II button to select the sound output.

L+R: Audio signal from audio L input is sent to the left loudspeakers and audio signal from audio R input is sent to the right loudspeakers.

L+L: Audio signal from audio L input is sent to left and right loudspeakers.

R+R: Audio signal from audio R input is sent to left and right loudspeakers.

SOUND & LANGUAGE CONTROL

ON-SCREEN MENU LANGUAGE SELECTION

The menus can be shown on the screen in the selected language. First select your language.

- 1 Press the **MENU** button and then use ▲ / ▼ button to select the **Option** menu.

- 2 Press the ► button and then use ▲ / ▼ button to select **Language**.

- 3 Press the ► button and then use ▲ / ▼ button to select your desired language.

- 4 Press the OK button

- 5 Press the **EXIT** button to return to normal TV viewing.

! NOTE

- ▶ If you intend to be away on vacation, disconnect the power plug from wall power outlet.



TIME SETTING

CLOCK SETUP

You must set the time correctly before using on/off timer function.

If current time setting is erased by a power failure or the TV is unplugged, reset the clock.



1 Press the **MENU** button and then ▲ / ▼ button to select the **Time** menu.

2 Press the ► button and then ▲ / ▼ button to select **Clock**.

3 Press the ► button and then ▲ / ▼ button to set the hour.

4 Press the ► button and then ▲ / ▼ button to set the minute.

5 Press the **EXIT** button to return to normal TV viewing.

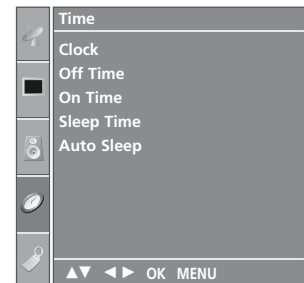

1

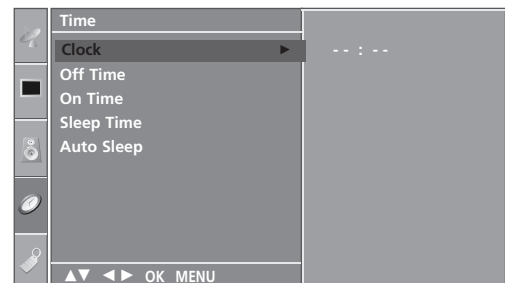

2 3 4

TIME SETTING

AUTO ON/OFF TIMER SETTING

The Off time function automatically switches the TV to standby at a preset time.

Two hours after the TV is switched on by the on time function it will automatically switch back to standby mode unless a button has been pressed.

Once the on time/off time is set, these functions operate daily at the preset time.

The Off time function overrides the On timer function if both are set to the same time.

The TV must be in standby mode for the On timer to work.



1 Press the **MENU** button and then **▲ / ▼** button to select the **Time** menu.

2 Press the **▶** button and then **▲ / ▼** button to select **Off Time/On Time**.

3 Press the **▶** button and then **▲ / ▼** button to select **On**.
• To cancel **On/Off Time** function, select **Off**.

4 Press the **▶** button and then **▲ / ▼** button to set the hour.

5 Press the **▶** button and then **▲ / ▼** button to set the minutes.

6 **For On Time function only**
• **Programme:** Press the **▶** button and then **▲ / ▼** button to select the programme.
• **Volume:** Press the **▶** button and then **▲ / ▼** button to adjust volume level at switch-on.

7 Press the **EXIT** button to return to normal TV viewing.

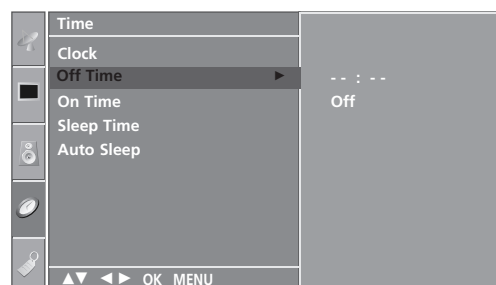
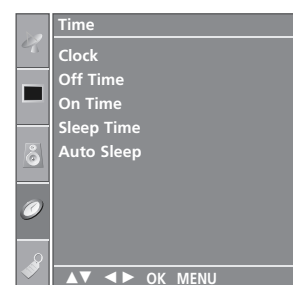

3 4 5

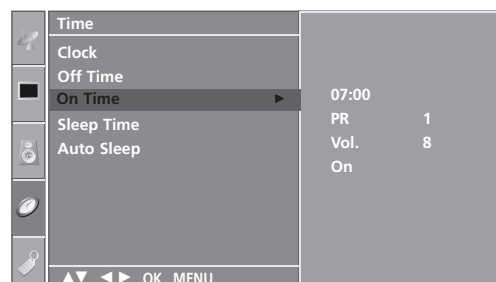

2 3 4 5 6

SLEEP TIMER SETTING

You do not have to remember to switch the TV off before you go to sleep. The sleep timer automatically switches the TV to standby after the preset time has elapsed.

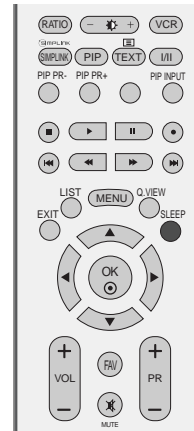

- 1 Press the **SLEEP** button repeatedly to select the number of minutes. The display '  - - - ' will appear on the screen, followed by 10, 20, 30, 60, 90, 120, 180 and 240.
- 2 When the number of minutes required is displayed on the screen, the timer begins to count down from the number of minutes selected.

■ You can also set up the Sleep Time in the **Time** menu.

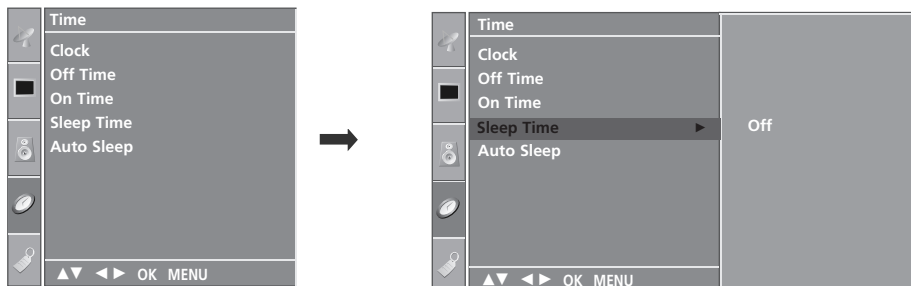

! NOTE

- ▶ To view the remaining sleep time, press the **SLEEP** button once.
- ▶ To cancel the sleep time, repeatedly press the **SLEEP** button until the display '  - - - ' appears.
- ▶ When you switch the TV off, the TV releases the preset sleep time.

TIME SETTING

AUTO SHUT-OFF SETTING

If the TV set is switched on and there is no input signal, it will switch off automatically after 10 minutes.



- 1 Press the **MENU** button and then **▲ / ▼** button to select the **Time** menu.
- 2 Press the **▶** button and then **▲ / ▼** button to select **Auto Sleep**.
- 3 Press the **▶** button and then **▲ / ▼** button to select **On** or **Off**.
- 4 Press the **EXIT** button to return to normal TV viewing.

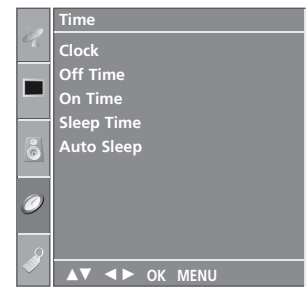

1

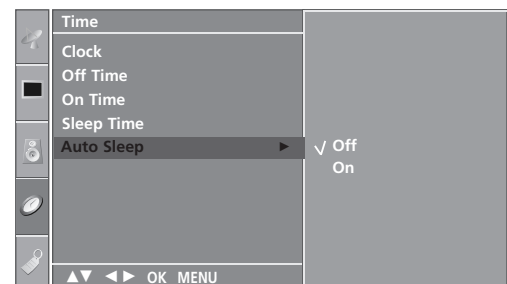

2 3

TELETEXT

This feature is not available in all countries.

Teletext is a free service broadcast by most TV stations which gives up-to-the-minute information on news, weather, television programmes, share prices and many other topics.

The teletext decoder of this TV can support the SIMPLE, TOP and FASTEXT systems. SIMPLE (standard teletext) consists of a number of pages which are selected by directly entering the corresponding page number. TOP and FASTEXT are more modern methods allowing quick and easy selection of teletext information.

SWITCH ON/OFF

Press the **TEXT** button to switch to teletext. The initial page or last page viewed appears on the screen.

Two page numbers, TV station name, date and time are displayed on the screen headline. The first page number indicates your selection, while the second shows the current page displayed.

Press the **TEXT** or **EXIT** button to switch off teletext. The previous mode reappears.

SIMPLE TEXT

■ Page selection

- 1 Enter the desired page number as a three digit number with the NUMBER buttons. If during selection you press a wrong number, you must complete the three digit number and then re-enter the correct page number.
- 2 The PR+/- button can be used to select the preceding or following page.

TELETEXT

TOP TEXT

The user guide displays four fields-red, green, yellow and blue at the bottom of the screen. The yellow field denotes the next group and the blue field indicates the next block.

■ Block / group / page selection

- ① With the blue button you can progress from block to block.
- ② Use the yellow button to proceed to the next group with automatic overflow to the next block.
- ③ With the green button you can proceed to the next existing page with automatic overflow to the next group. Alternatively the **PR+** button can be used.
- ④ The red button return to the previous selection. Alternatively the **PR-** button can be used.

■ Direct page selection

As with SIMPLE teletext mode, you can select a page by entering it as a three digit number using the **NUMBER** buttons in **TOP** mode.

FASTEXT

The teletext pages are colour coded along the bottom of the screen and are selected by pressing the corresponding coloured button.

■ Page selection

- ① Press the  button to select the index page.
- ② You can select the pages which are colour coded along the bottom line with corresponding coloured buttons.
- ③ As with SIMPLE teletext mode, you can select a page by entering its three digit page number with the **NUMBER** buttons in **FASTEXT** mode.
- ④ The **PR+/-** button can be used to select the preceding or following page.

SPECIAL TELETEXT FUNCTIONS



■ REVEAL

Press this button to display concealed information, such as solutions to riddles or puzzles.
Press this button again to remove the information from the display.



■ SIZE

Selects double height text.
Press this button to enlarge the top half of the page.
Press this button again to enlarge the bottom half of the page.
Press this button again to return to the normal display.



■ UPDATE

Displays the TV picture on the screen while waiting for a new teletext page. The display will appear at the top left hand corner of the screen. When the updated page is available then display will change to the page number. Press this button again to view the updated teletext page.



■ TIME

When viewing a TV programme, press this button to display the time at the top right hand corner of the screen. Press this button again to remove the display. In the teletext mode, press this button to select a sub page number. The sub page number is displayed at the bottom of the screen. To hold or change the sub page, press the RED/GREEN, **PR+/-** or NUMBER buttons.
Press again to exit this function.



■ HOLD

Stops the automatic page change which will occur if a teletext page consists of 2 or more sub pages. The number of sub pages and the sub page displayed is, usually, shown on the screen below the time. When this button is pressed the stop symbol is displayed at the top left-hand corner of the screen and the automatic page change is inactive. To continue press this button again.

APPENDIX

TROUBLESHOOTING

The TV does not operate properly	
The remote control does not work	<ul style="list-style-type: none">■ Check to see if there is any object between the TV and the remote control causing an obstruction.■ Are batteries installed with correct polarity (+ to +, - to -)?■ Correct remote operating mode set: TV, VCR etc.?■ Install new batteries.
Power is suddenly turned off	<ul style="list-style-type: none">■ Is the sleep time set?■ Check the power control settings. Has the Power supply been interrupted.■ Is Auto sleep activated on this station.

The video function does not work.	
No picture & No sound	<ul style="list-style-type: none">■ Check whether the TV is switched on.■ Try another channel. The problem may be with the broadcast.■ Is the power cord inserted correctly into the mains?■ Check your antenna direction and/or location.■ Test the mains outlet by plugging another TV into the same outlet.
Picture appears slowly after switching on	<ul style="list-style-type: none">■ This is normal, the image is muted during the TV startup process. Please contact your service center, if the picture has not appeared after five minutes.
No or poor colour or poor picture	<ul style="list-style-type: none">■ Adjust Colour in menu option.■ Allow a sufficient distance between the TV and the VCR.■ Try another channel. The problem may be with the broadcast.■ Are the video cables installed properly?■ Activate any function to restore the brightness of the picture.
Horizontal/vertical bars or picture shaking	<ul style="list-style-type: none">■ Check for local interference such as an electrical appliance or power tool.
Poor reception on some channels	<ul style="list-style-type: none">■ Station or cable channel experiencing problems, tune to another station.■ Station signal is weak, reposition the antenna to receive weaker stations.■ Check for sources of possible interference.
Lines or streaks in pictures	<ul style="list-style-type: none">■ Check antenna (Change the position of the antenna).

The audio function does not work.

Picture OK & No sound

- Press the **VOL+/- (or Volume)** button.
- Sound muted? Press **MUTE** button.
- Try another channel. The problem may be with the broadcast.
- Are the audio cables installed properly?

No output from one of the speakers

- Adjust Balance in menu option.

Unusual sound from inside the TV

- A change in ambient humidity or temperature may result in an unusual noise when the TV is switched on or off and does not indicate a fault with the TV.

There is a problem in PC mode. (Only PC mode applied)

The signal is out of range.

- Adjust resolution, horizontal frequency, or vertical frequency.
- Check the input source.

Vertical bar or stripe on background & Horizontal Noise & Incorrect position

- Use Auto configure or adjust clock, phase, or H/V position.

Screen colour is unstable or single colour

- Check the signal cable.
- Reinstall the PC video card.

APPENDIX

MAINTENANCE

Early malfunctions can be prevented. Careful and regular cleaning can prolong the life of your new TV.
Caution: Be sure to switch the power off and unplug the power cord before you begin any cleaning.

Cleaning the Screen

- 1 A good way to keep the dust off your screen for a while is to wet a soft cloth in a mixture of lukewarm water and a little fabric softener or dish washing detergent. Wring the cloth until it's almost dry, and then use it to wipe the screen.
- 2 Ensure there is no excess water on the screen. Allow any water or dampness to evaporate before switching on.

Cleaning the Cabinet

- To remove dirt or dust, wipe the cabinet with a soft, dry, lint-free cloth.
- Do not use a wet cloth.

Extended Absence

CAUTION

- ▶ If you expect to leave your TV dormant for prolonged periods (such as a holiday), unplug the power cord to protect against possible damage from lightning or power surges.

PRODUCT SPECIFICATIONS

MODELS		26LC4R*	32LC4R*	37LC4R*	42LC4R*
		26LC4R-TA/26LC4R-TS 26LC4R-B-TF	32LC4R-TA/32LC4R-TB 32LC4R-TS/32LC4R-TD 32LC4R-B-TF	37LC4R-TA/37LC4R-TB 37LC4R-TS/37LC4R-TD 37LC4R-B-TF	42LC4R-TA/42LC4R-TB 42LC4R-TS/42LC4R-TD 42LC4R-B-TF
Dimensions (Width x Height x Depth)	with stand	676.4 x 529.2 x 221.0 mm 26.6 x 20.8 x 8.7 inches	806.4 x 606.1 x 249.0 mm 31.8 x 23.9 x 9.8 inches	926.6 x 697.6 x 280.4 mm 36.5 x 27.5 x 11.0 inches	1032.7 x 750.0 x 287.6 mm 40.7 x 29.5 x 11.3 inches
	without stand	676.4 x 474.3 x 85.0 mm 26.6 x 18.7 x 3.3 inches	806.4 x 548.4 x 80.5 mm 31.8 x 21.6 x 3.2 inches	926.6 x 635.6 x 88.0 mm 36.5 x 25.0 x 3.5 inches	1032.7 x 685.5 x 88.5 mm 40.7 x 27.0 x 3.5 inches
Weight	with stand	10.1 kg / 22.3 lbs	13.9 kg / 30.7 lbs	20.0 kg / 44.1 lbs	24.5 kg / 54.0 lbs
	without stand	9.1 kg / 20.1 lbs	11.3 kg / 24.9 lbs	16.3 kg / 35.9 lbs	20 kg / 44.1 lbs
Power requirement		AC100-240V~ 50/60Hz 1.3A	AC100-240V~ 50/60Hz 1.5A	AC100-240V~ 50/60Hz 1.8A	AC100-240V~ 50/60Hz 2.2A
MODELS		26LC7R*	32LC7R*	37LC7R*	42LC7R*
		26LC7R-TA/26LC7R-TB 26LC7R-TS/26LC7R-B-TD	32LC7R-TA/32LC7R-TB 32LC7R-TS/32LC7R-TD 32LC7R-RA-TA/32LC7R-RA-TB 32LC7R-RA-TS/32LC7R-RA-TD	37LC7R-TA/37LC7R-TB 37LC7R-TS/37LC7R-TD 37LC7R-TJ/37LC7R-TS 37LC7R-B-TD	42LC7R-TA/42LC7R-TB 42LC7R-TS/42LC7R-B-TD
Dimensions (Width x Height x Depth)	with stand	676.6 x 531.0 x 221.0 mm 26.6 x 20.9 x 8.7 inches	806.6 x 606.5 x 249 mm 31.8 x 23.9 x 9.8 inches	927 x 692.8 x 280.5 mm 36.5 x 27.3 x 11.1 inches	1033.4 x 750.0 x 287.6 mm 40.7 x 29.5 x 11.3 inches
	without stand	676.6 x 478.7 x 84.0 mm 26.6 x 18.9 x 3.3 inches	806.6 x 552.3 x 79 mm 31.8 x 21.8 x 3.1 inches	927 x 630 x 88.0 mm 36.5 x 24.8 x 3.5 inches	1033.4 x 686.8 x 88.5 mm 40.7 x 27.0 x 3.5 inches
Weight	with stand	10.4 kg / 22.9 lbs	13.7 kg / 30.2 lbs	20.0 kg / 44.1 lbs	24.9 kg / 54.9 lbs
	without stand	9.0 kg / 19.9 lbs	11.2 kg / 24.7 lbs	16.0 kg / 35.3 lbs	20.4 kg / 45.0 lbs
Power requirement		AC100-240V~ 50/60Hz 1.3A	AC100-240V~ 50/60Hz 1.5A	AC100-240V~ 50/60Hz 1.8A	AC100-240V~ 50/60Hz 2.2A
Television System		PAL/SECAM B/G/D/K, PAL I/II, NTSC-M			
Program Coverage		VHF: NZ1 ~ E21, UHF: E21 ~ E69, CATV: S1 ~ S20, HYPER: S21 ~ S47			
External Antenna Impedance		75 Ω			
Environment condition	Operating Temperature	0 ~ 40°C / 32 ~ 104°F			
	Operating Humidity	Less than 80%			
	Storage Temperature	-20 ~ 60°C / -4 ~ 140°F			
	Storage Humidity	Less than 85%			

* ■ The specifications shown above may be changed without prior notice for quality improvement.

APPENDIX

PRODUCT SPECIFICATIONS

MODELS		42PC5R*	42PC5RV*	42PC7R*	50PC5R*
		42PC5R-TB/42PC5R-TD 42PC5R1-TB/42PC5R1-TD 42PC5RH-TB/42PC5RH-TD 42PC5RC-TB/42PC5RC-TD	42PC5RV-TB/42PC5RV-TD 42PC5RVH-TB/42PC5RVH-TD 42PC5RVC-TB/42PC5RVC-TD	42PC7RV-TA 42PC7RVH-TA 42PC7RVC-TA	50PC5R-TB/50PC5R-TD 50PC5R1-TB/50PC5R1-TD 50PC5RH-TB/50PC5RH-TD 50PC5RC-TB/50PC5RC-TD
Dimensions (Width x Height x Depth)	with stand	1048.0 x 766.0 x 310.0 mm 41.3 x 30.2 x 12.2 inches	1048.0 x 766.0 x 310.0 mm 41.3 x 30.2 x 12.2 inches	1216.0 x 701.0 x 286.5 mm 479 x 276 x 11.3 inches	1242.0 x 887.6 x 370.0 mm 48.9 x 34.9 x 14.6 inches
	without stand	1048.0 x 713.0 x 83.5 mm 41.3 x 28.1 x 3.3 inches	1048.0 x 713.0 x 83.5 mm 41.3 x 28.1 x 3.3 inches	1216.0 x 649.0 x 85.0 mm 479 x 25.6 x 3.3 inches	1242.0 x 827.2 x 88.0 mm 48.9 x 32.6 x 3.5 inches
Weight	with stand	28.0 kg / 61.7 lbs	28.0 kg / 61.7 lbs	28.2 kg / 62.2 lbs	39.3 kg / 86.6 lbs
	without stand	24.6 kg / 54.2 lbs	24.6 kg / 54.2 lbs	25.5 kg / 56.2 lbs	34.6 kg / 76.2 lbs
Power requirement		AC100-240V~ 50/60Hz 3.5A	AC100-240V~ 50/60Hz 3A	AC100-240V~ 50/60Hz 3A	AC100-240V~ 50/60Hz 5.0A
MODELS		32LB9R*		42LB9R*	
		32LB9R-TA / 32LB9R1-TA / 32LB9RA-TA / 32LB9RB-TA 32LB9R-TB / 32LB9R1-TB / 32LB9RA-TB / 32LB9RB-TB 32LB9R-TD / 32LB9R1-TD / 32LB9RA-TD / 32LB9RB-TD		42LB9R-TA / 42LB9R1-TA / 42LB9RA-TA / 42LB9RB-TA 42LB9R-TB / 42LB9R1-TB / 42LB9RA-TB / 42LB9RB-TB 42LB9R-TD / 42LB9R1-TD / 42LB9RA-TD / 42LB9RB-TD	
Dimensions (Width x Height x Depth)	with stand	805.8x619.7x283.9 mm 31.7x24.4x11.2 inches		1030.8x779.8x333.2 mm 40.6x30.7x13.1 inches	
	without stand	805.8x554.1x79.0 mm 31.7x21.8x3.1 inches		1030.8x693x88.5 mm 40.6x27.3x3.5 inches	
Weight	with stand	14.8 kg / 32.6 lbs		24.2 kg / 53.4 lbs	
	without stand	12.6 kg / 27.8 lbs		20.3 kg / 44.8 lbs	
Power requirement		AC100-240V~ 50/60Hz 1.5A		AC100-240V~ 50/60Hz 2.1A	
Television System		PAL/SECAM B/G/D/K, PAL I/II, NTSC-M			
Program Coverage		VHF: NZ1 ~ E21, UHF: E21 ~ E69, CATV: S1 ~ S20, HYPER: S21 ~ S47			
External Antenna Impedance		75 Ω			
Environment condition	Operating Temperature	0 ~ 40°C / 32 ~ 104°F			
	Operating Humidity	Less than 80%			
	Storage Temperature	-20 ~ 60°C / -4 ~ 140°F			
	Storage Humidity	Less than 85%			

* ■ The specifications shown above may be changed without prior notice for quality improvement.

PROGRAMMING THE REMOTE CONTROL

The remote control is a multi brand or universal remote. It can be programmed to operate most remote controlled devices from other manufacturers.

Note that the remote control may not control all models from other brands.

Programming a code into a remote mode

- 1 Testing your remote control.
To find out whether your remote control can operate other components without programming, turn on a component such as a VCR and press the corresponding mode button (such as a **DVD** or **VCR**(or **STB**)) on the remote control, while pointing at the component. Test the **POWER** and **PR + / -** buttons to see if the component responds correctly. If the component does not operate correctly, the remote control requires programming to operate the device.
- 2 Switch on the component to be programmed, then press the corresponding mode button (such as a **DVD** or **VCR**(or **STB**)) on the remote control. The remote control button of the desired device is illuminated.
- 3 Press the **MENU** and **MUTE** buttons simultaneously, the remote control is ready to be programmed with the code.
- 4 Enter a code number using the number buttons on the remote control. Programming code numbers for the corresponding component can be found on the following pages. If the code is correct, the device will turn off.
- 5 Press the **MENU** button to store the code.
- 6 Test the remote control functions to see if the component responds correctly. If not, repeat from step 2.

APPENDIX

Programming code

(This feature is not available for all models.)

VCR

Brand	Codes	Brand	Codes	Brand	Codes
AIWA	034	MAGNAVOX	031 033 034 041	SAMSUNG	032 040 102 104
AKAI	016 043 046 124		067 068		105 107 109 112
	125 146	MARANTZ	012 031 033 067		113 115 120 122
AMPRO	072		069		125
ANAM	031 033 103	MARTA	101	SANSUI	022 043 048 135
AUDIO DYNAMICS	012 023 039 043	MATSUI	027 030	SANYO	003 007 010 014
BROKSONIC	035 037 129	MEI	031 033		102 134
CANON	028 031 033	MEMOREX	003 010 014 031	SCOTT	017 037 112 129
CAPEHART	108		033 034 053 072		131
CRAIG	003 040 135		101 102 134 139	SEARS	003 008 009 010
CURTIS MATHES	031 033 041	MGA	045 046 059		013 014 017 020
DAEWOO	005 007 010 064	MINOLTA	013 020		031 042 073 081
	065 108 110 111	MITSUBISHI	013 020 045 046	SHARP	031 054 149
	112 116 117 119		049 051 059 061	SHINTOM	024
DAYTRON	108		151	SONY	003 009 031 052
DBX	012 023 039 043	MTC	034 040		056 057 058 076
DYNATECH	034 053	MULTITECH	024 034		077 078 149
ELECTROHOME	059	NEC	012 023 039 043	SOUNDESIGN	034
EMERSON	006 017 025 027		048	STS	013
	029 031 034 035	NORDMENDE	043	SYLVANIA	031 033 034 059
	036 037 046 101	OPTONICA	053 054		067
	129 131 138 153	PANASONIC	066 070 074 083	SYMPHONIC	034
FISHER	003 008 009 010		133 140 145	TANDY	010 034
FUNAI	034	PENTAX	013 020 031 033	TATUNG	039 043
GE	031 033 063 072		063	TEAC	034 039 043
	107 109 144 147	PHILCO	031 034 067	TECHNICS	031 033 070
GO VIDEO	132 136	PHILIPS	031 033 034 054	TEKNIKA	019 031 033 034
HARMAN KARDON	012 045		067 071 101		101
HITACHI	004 018 026 034	PILOT	101	THOMAS	034
	043 063 137 150	PIONEER	013 021 048	TMK	006
INSTANTREPLAY	031 033	PORTLAND	108	TOSHIBA	008 013 042 047
JCL	031 033	PULSAR	072		059 082 112 131
JCPENNY	012 013 015 033	QUARTZ	011 014	TOTEVISION	040 101
	040 066 101	QUASAR	033 066 075 145	UNITECH	040
JENSEN	043	RCA	013 020 033 034	VECTOR RESEARCH	012
JVC	012 031 033 043		040 041 062 063	VICTOR	048
	048 050 055 060		107 109 140 144	VIDEO CONCEPTS	012 034 046
	130 150 152		145 147	VIDEOSONIC	040
KENWOOD	014 034 039 043	REALISTIC	003 008 010 014	WARDS	003 013 017 024
	047 048		031 033 034 040		031 033 034 040
LG (GOLDSTAR)	001 012 013 020		053 054 101		053 054 131
	101 106 114 123	RICO	058	YAMAHA	012 034 039 043
LLOYD	034	RUNCO	148	ZENITH	034 048 056
LXI	003 009 013 014	SALORA	014		058 072 080 101
	017 034 101 106				
MAGIN	040				

DVD

Brand	Codes	Brand	Codes	Brand	Codes
APEX DIGITAL	022	mitsubishi	002	RCA	005 006
DENON	020 014	NAD	023	SAMSUNG	011 015
GE	005 006	ONKYO	008 017	SONY	007
HARMAN KARDON	027	PANASONIC	003 009	THOMPSON	005 006
JVC	012	PHILIPS	013	TOSHIBA	019 008
LG	001 010 016 025	PIONEER	004 026	YAMAHA	009 018
MAGNAVOX	013	PROCEED	021	ZENITH	010 016 025
MARANTZ	024	PROSCAN	005 006		

STB

Brand	Codes	Remark	Receiver Model Code	Receiver Model Name
Astro Philips(ML)	007		S6000232753065	DSX7072/68H
Astro Thompson(ML)	008		32888TC0472790	DVB 850S
Astro Nokia(ML)	009		9084163	8750S
Humax(SL)	006			
PSI(TH)	005		PR105 II	BONUS
Samart(TH)	004	Samart DTH	IRD DTH-1	CO-CHIP
True Vision(TH)	003	5th STB of UBC(New)	TF6300IR	TOPFIELD
VTC(VN)	010			
UBC(TH)	001	1 st STB of UBC	IRD 5000	Pace
UBC/Samart(TH)	002	2nd-4th STB of UBC/Samart DSTV	ABS3Q76/ABS 8976/ABS 9976/ABS 2400	3Q

LG Electronics Inc.

Free Manuals Download Website

<http://myh66.com>

<http://usermanuals.us>

<http://www.somanuals.com>

<http://www.4manuals.cc>

<http://www.manual-lib.com>

<http://www.404manual.com>

<http://www.luxmanual.com>

<http://aubethermostatmanual.com>

Golf course search by state

<http://golfingnear.com>

Email search by domain

<http://emailbydomain.com>

Auto manuals search

<http://auto.somanuals.com>

TV manuals search

<http://tv.somanuals.com>