



ENGLISH

ESPAÑOL

OWNER'S MANUAL

DRYER

Please read this owner's manual thoroughly before operating and keep it handy for reference at all times.

DLEX5780*E DLGX5781*E



MFL67731040

www.lg.com

TABLE OF CONTENTS

3 IMPORTANT SAFETY INSTRUCTIONS

- 3 WHAT TO DO IF YOU SMELL GAS
- 4 BASIC SAFETY PRECAUTIONS
- 4 CALIFORNIA SAFE DRINKING WATER AND TOXIC ENFORCEMENT ACT
- 5 GROUNDING INSTRUCTIONS
- 5 SAFETY INSTRUCTIONS FOR INSTALLATION
- 7 SAFETY INSTRUCTIONS FOR CONNECTING ELECTRICITY

8 PRODUCT FEATURES

9 INTRODUCING YOUR DRYER

- 9 Parts and Accessories
- 9 2-Way Reversible Door
- 10 Control Panel Features
- 11 Display

12 INSTALLATION INSTRUCTIONS

- 12 Preview Installation Order
- 13 Installation Location Requirements
- 13 Clearances
- 14 Leveling the Dryer
- 15 Reversing the Door
- 21 Installing the Side Vent Kit
- 22 Venting the Dryer
- 24 Connecting Gas Dryers
- 26 Connecting Electric Dryers
- 31 Special Requirements for Manufactured or Mobile Homes
- 31 Final Installation Check
- 32 Installation Test (Duct Check)

34 HOW TO USE

- 34 Operating the Dryer
- 35 Sorting Loads
- 35 Loading the Dryer
- 35 Check the Lint Filter Before Every Load
- 36 Using the LG EasyLoad™
- 37 Cycle Guide
- 38 Cycle Settings and Options
- 38 Special Functions

- 39 Custom Program
- 39 Steam Functions
- 41 Steam Cycle Guide
- 42 Tag On
- 43 Using Tag On with Applications

49 MAINTENANCE

- 49 Regular Cleaning

50 TROUBLESHOOTING

- 50 Before Calling for Service

53 SPECIFICATIONS

54 USING SMART DIAGNOSIS™

55 WARRANTY

IMPORTANT SAFETY INSTRUCTIONS

READ ALL INSTRUCTIONS BEFORE USE

WARNING

For your safety, the information in this manual must be followed to minimize the risk of fire or explosion, electric shock, or to prevent property damage, injury to persons, or death.

Your safety and the safety of others is very important.

We have provided many important safety messages in this manual and on your appliance. Always read and obey all safety messages.



This is the safety alert symbol.

This symbol alerts you to potential hazards that can kill or hurt you and others.

All safety messages will follow the safety alert symbol and either the word DANGER, WARNING, or CAUTION.

These words mean:



DANGER

You will be killed or seriously injured if you don't immediately follow instructions.



WARNING

You can be killed or seriously injured if you don't follow instructions.



CAUTION

You may be slightly injured or cause damage to the product if you do not follow instructions.

All safety messages will tell you what the potential hazard is, tell you how to reduce the chance of injury, and tell you what can happen if the instructions are not followed.

- **Do not install a clothes dryer with flexible plastic venting materials. If flexible metal (foil type) duct is installed, it must be of a specific type identified by the appliance manufacturer as suitable for use with clothes dryers. Flexible venting materials are known to collapse, be easily crushed, and trap lint. These conditions will obstruct clothes dryer airflow and increase the risk of fire.**
- **Do not store or use gasoline or other flammable vapors and liquids in the vicinity of this appliance or any other appliances.**
- **Installation and service must be performed by a qualified installer, service agency, or the gas supplier.**
- **Install the clothes dryer according to the manufacturer's instructions and local codes.**
- **Save these instructions.**

WHAT TO DO IF YOU SMELL GAS:

- 1. Do not try to light a match or cigarette, or turn on any gas or electrical appliance.**
- 2. Do not touch any electrical switches. Do not use any phone in your building.**
- 3. Clear the room, building, or area of all occupants.**
- 4. Immediately call your gas supplier from a neighbor's phone. Follow the gas supplier's instructions carefully.**
- 5. If you cannot reach your gas supplier, call the fire department.**

 **WARNING:** This product contains chemicals known to the State of California to cause cancer and birth defects or other reproductive harm. *Wash hands after handling.*

IMPORTANT SAFETY INSTRUCTIONS

READ ALL INSTRUCTIONS BEFORE USE

⚠ WARNING

For your safety, the information in this manual must be followed to minimize the risk of fire or explosion, electric shock, or to prevent property damage, injury to persons, or death.

BASIC SAFETY PRECAUTIONS

⚠ WARNING

To reduce the risk of fire, electric shock, or injury to persons when using this appliance, follow basic precautions, including the following:

- Read all instructions before using the dryer.
- Before use, the dryer must be properly installed as described in this manual.
- Do not place items exposed to cooking oils in your dryer. Items contaminated with cooking oils may contribute to a chemical reaction that could cause a load to catch fire.
- Do not dry articles that have been previously cleaned in, washed in, soaked in, or spotted with gasoline, dry-cleaning solvents, or other flammable or explosive substances as they give off vapors that could ignite or explode.
- Do not reach into the dryer if the drum or any other part is moving.
- Do not repair or replace any part of the dryer or attempt any servicing unless specifically recommended in this owner's manual or in published user-repair instructions that you understand and have the skills to carry out.
- Do not tamper with controls.
- Before the dryer is removed from service or discarded, remove the door to the drying compartment.
- Do not allow children to play on or in the dryer. Close supervision of children is necessary when the dryer is used near children.
- Do not use fabric softeners or products to eliminate static unless recommended by the manufacturer of the fabric softener or product.
- Do not use heat to dry articles containing foam rubber or similarly textured rubber-like materials.
- Keep area around the exhaust opening and adjacent surrounding areas free from the accumulation of lint, dust, and dirt.
- The interior of the dryer and exhaust vent should be cleaned periodically by qualified service personnel.
- Do not install or store the dryer where it will be exposed to the weather.
- Always check the inside of the dryer for foreign objects.
- Clean lint screen before or after each load.
- **Do not store plastic, paper, or clothing that may burn or melt on top of the dryer during operation.**
- Be careful when opening and closing the door. Fingers and hands can get caught in the door and cause injury if the door drops forward unexpectedly.
- **Do not place heavy items on or lean against the top of the door when it is open.**
- **Do not attempt to pull the hamper door open more than 40 degrees.**
 - The dryer could tip forward, causing injury or damage.
 - Do not place items on the top of the dryer.

CALIFORNIA SAFE DRINKING WATER AND TOXIC ENFORCEMENT ACT

This act requires the governor of California to publish a list of substances known to the state to cause cancer, birth defects, or other reproductive harm and requires businesses to warn customers of potential exposure to such substances.

Gas appliances can cause minor exposure to four of these substances, namely benzene, carbon monoxide, formaldehyde, and soot, caused primarily by the incomplete combustion of natural gas or LP fuels.

Properly adjusted dryers will minimize incomplete combustion. Exposure to these substances can be minimized further by properly venting the dryer to the outdoors.

IMPORTANT SAFETY INSTRUCTIONS

READ ALL INSTRUCTIONS BEFORE USE

WARNING

For your safety, the information in this manual must be followed to minimize the risk of fire or explosion, electric shock, or to prevent property damage, injury to persons, or death.

GROUNDING INSTRUCTIONS

This appliance must be grounded. In the event of malfunction or breakdown, grounding will reduce the risk of electric shock by providing a path of least resistance for electric current. This appliance must be equipped with a cord having an equipment-grounding conductor and a grounding plug. The plug must be plugged into an appropriate outlet that is properly installed and grounded in accordance with all local codes and ordinances.

Do not modify the plug provided with the appliance. If it will not fit the outlet, have a proper outlet installed by a qualified electrician.

This appliance must be connected to a grounded metal, permanent wiring system or an equipment-grounding conductor must be run with the circuit conductors and connected to the equipment-grounding terminal or lead on the appliance.

Electric shock can result if the dryer is not properly grounded.

WARNING

Improper connection of the equipment-grounding conductor can result in a risk of electric shock. Check with a qualified electrician or service person if you are in doubt that the appliance is properly grounded.

SAFETY INSTRUCTIONS FOR INSTALLATION

WARNING

To reduce the risk of fire, electric shock, or injury to persons when using this appliance, follow basic precautions, including the following:

- **Properly ground dryer to conform with all governing codes and ordinances.** Follow details in the installation instructions. Electric shock can result if the dryer is not properly grounded.
- **Before use, the dryer must be properly installed** as described in this manual. Electric shock can result if the dryer is not properly grounded.
- **Install and store the dryer where it will not be exposed to temperatures below freezing or exposed to the weather.**
- **All repairs and servicing must be performed by an authorized servicer unless specifically recommended in this owner's manual. Use only authorized factory parts.** Failure to follow this warning can cause serious injury, fire, electric shock, or death.
- **To reduce the risk of electric shock, do not install the dryer in humid spaces.** Failure to follow this warning can cause serious injury, fire, electric shock, or death.
- **Connect to a properly rated, protected, and sized power circuit to avoid electrical overload.** Improper power circuit can melt, creating electric shock and/or fire hazard.
- **Remove all packing items and dispose of all shipping materials properly.** Failure to do so can result in death, explosion, fire, or burns.
- **Place dryer at least 18 inches above the floor for a garage installation.** Failure to do so can result in death, explosion, fire, or burns.
- **Keep all packaging from children.** Packaging material can be dangerous for children. There is a risk of suffocation.
- **Do not install near another source of heat such as a stove, cooking oven.** Failure to do so can cause deform, smoke and fire.
- **Do not place candles, smoking materials, or other flammables on top of the product.** Dripping wax, smoke, or fire can result.
- **Remove all protective vinyl film from the product.** Failure to do so can cause product damage, smoke or fire.

IMPORTANT SAFETY INSTRUCTIONS

READ ALL INSTRUCTIONS BEFORE USE

⚠ WARNING

For your safety, the information in this manual must be followed to minimize the risk of fire or explosion, electric shock, or to prevent property damage, injury to persons, or death.

SAFETY INSTRUCTIONS FOR INSTALLATION

⚠ WARNING

To reduce the risk of injury to persons, follow all industry recommended safety procedures including the use of long sleeved gloves and safety glasses. Failure to follow all of the safety warnings in this manual could result in property damage, injury to persons, or death.

Exhaust/Ducting:

- **Gas dryers MUST be exhausted to the outside.** Failure to follow these instructions can result in fire or death.
- **The dryer exhaust system must be exhausted to the outside of the dwelling. If the dryer is not exhausted outdoors, some fine lint and large amounts of moisture will be expelled into the laundry area.** An accumulation of lint in any area of the home can create a health and fire hazard.
- **Use only rigid metal or flexible metal 4-inch diameter ductwork inside the dryer cabinet or for exhausting to the outside. Use of plastic or other combustible ductwork can cause a fire.** Punctured ductwork can cause a fire if it collapses or becomes otherwise restricted in use or during installation.
- **Ductwork is not provided with the dryer, and you should obtain the necessary ductwork locally. The end cap should have hinged dampers to prevent backdraft when the dryer is not in use.** Failure to follow these instructions can result in fire or death.
- **The exhaust duct must be 4 inches (10.2 cm) in diameter with no obstructions. The exhaust duct should be kept as short as possible. Make sure to clean any old ducts before installing your new dryer.** Failure to follow these instructions can result in fire or death.
- **Rigid or semi-rigid metal ducting is recommended for use between the dryer and the wall. In special installations when it is impossible to make a connection with the above recommendations, a UL-listed flexible metal transition duct may be used between the dryer and wall connection only. The use of this ducting will affect drying time.** Failure to follow these instructions can result in fire or death.
- **DO NOT use sheet metal screws or other fasteners which extend into the duct that could catch lint and reduce the efficiency of the exhaust system.** Secure all joints with duct tape. For complete details, follow the Installation Instructions. Failure to follow these instructions can result in fire or death.

IMPORTANT SAFETY INSTRUCTIONS

READ ALL INSTRUCTIONS BEFORE USE

⚠ WARNING

For your safety, the information in this manual must be followed to minimize the risk of fire or explosion, electric shock, or to prevent property damage, injury to persons, or death.

SAFETY INSTRUCTIONS FOR CONNECTING ELECTRICITY

⚠ WARNING

To reduce the risk of fire, electric shock, or injury to persons when using this appliance, follow basic precautions, including the following:

- **Do not, under any circumstances, cut or remove the ground prong from the power cord.** To prevent injury to persons or damage to the dryer, the electrical power cord must be plugged into a properly grounded outlet.
- **For personal safety, this dryer must be properly grounded.** Failure to do so can result in electric shock or injury.
- **Refer to the installation instructions in this manual for specific electrical requirements for your model.** Failure to follow these instructions can create an electric shock hazard and/or a fire hazard.
- **This dryer must be plugged into a properly grounded outlet. Electric shock can result if the dryer is not properly grounded. Have the wall outlet and circuit checked by a qualified electrician to make sure the outlet is properly grounded.** Failure to follow these instructions can create an electric shock hazard and/or a fire hazard.
- **The dryer should always be plugged into its own individual electrical outlet which has a voltage rating that matches the rating plate.** This provides sparkling performance and also prevents overloading house wiring circuits which could cause a fire hazard from overheated wires.
- **Never unplug your dryer by pulling on the power cord. Always grip plug firmly and pull straight out from the outlet.** The power cord can be damaged, resulting in a risk of fire and electric shock.
- **Repair or replace immediately all power cords that have become frayed or otherwise damaged. Do not use a cord that shows cracks or abrasion damage along its length or at either end.** The power cord can melt, creating an electric shock and/or fire hazard.
- **When installing or moving the dryer, be careful not to pinch, crush, or damage the power cord.** This will prevent injury and prevent damage to the dryer from fire and electric shock.

SAVE THESE INSTRUCTIONS

PRODUCT FEATURES

EASY-TO-USE CONTROL PANEL

Rotate the cycle selector knob to select the desired dry cycle. Add cycle options or adjust settings with the touch of a button.

2-WAY EASY-ACCESS REVERSIBLE DOOR

The LG EasyLoad™ can be tilted open from the top, hamper-style, allowing you to easily load the dryer without items falling on the floor. The door still swings open to provide easy access for unloading or loading of bulkier items. The door hinge can be reversed to adjust for installation location.

STEAM FUNCTIONS

LG's steam technology allows you to inject fabrics with a swirling jet of hot steam to refresh clothes, reduce static, and make ironing easier. Simply select the Steam Fresh™ cycle, or you can add a Steam option to selected cycles.

Flow Sense™ DUCT BLOCKAGE SENSING SYSTEM INDICATOR

The Flow Sense™ duct blockage sensing system detects and alerts you to restrictions in the installed household ductwork that reduce exhaust airflow through the dryer. If you see the alert: Clean or repair the ducts to remove the restrictions. Keep your ducts clean to help increase efficiency and reduce long drying times caused by blocked ducts.

Smart Diagnosis™

Should you experience any technical difficulty with your washing machine, it has the capability of transmitting data by phone to the Customer Information Center. The call center agent records the data transmitted from your machine and uses it to analyze the issue, providing a fast and effective diagnosis.

Tag On

The Tag On feature works on most smart phones equipped with the NFC function and based on the Android operating system (OS).

Using the "LG Smart Laundry" application, the Tag On feature will allow you to diagnose your appliance, download new cycles, and see the status of your appliance by simply touching the smartphone to the Tag On logo of the appliance.



Protocol P154
Sanitization Performance of
Residential Clothes dryer

INTRODUCING YOUR DRYER

Parts and Accessories

Parts

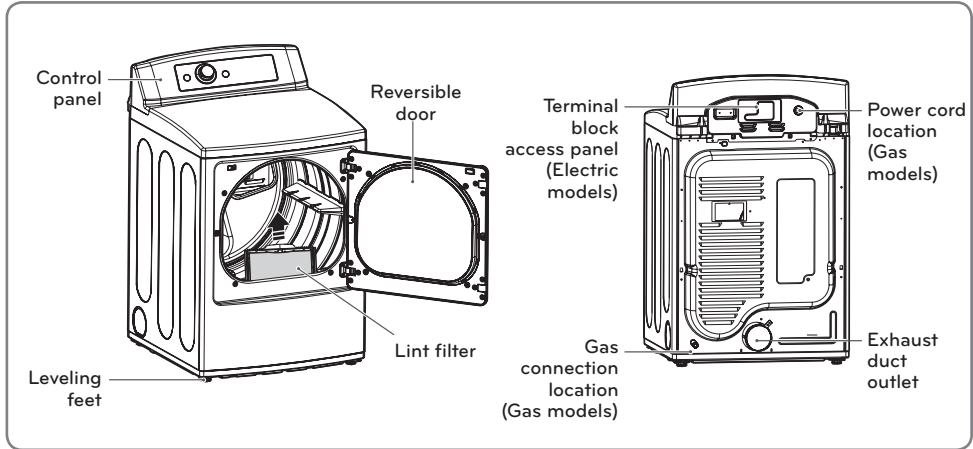

Accessories

Included Accessories



Drying rack
Part No.
3750EL0001C

Optional Accessories

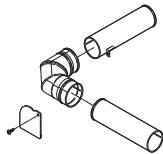

Side vent kit
(sold separately)
Kit No.
383EEL9001B

2-Way Reversible Door

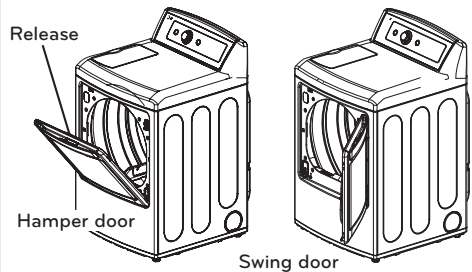

The LG EasyLoad™ feature allows you to open the dryer door from the top, hamper-style, when loading the dryer to help guide clothes into the drum and prevent them from falling onto the floor. When unloading the dryer or loading bulkier items, use the swing door for easy access to the drum. For more details on using the door, see page 36. For information on reversing the door swing, see page 15.

NOTE

- Contact LG Customer Service at 1-800-243-0000 (1-888-542-2623 in Canada) if any accessories are missing.
- For your safety and for extended product life, use only authorized components. The manufacturer is not responsible for product malfunction or accidents caused by the use of separately purchased unauthorized components or parts.
- The images in this owner's manual may be different from the actual components and accessories, and are subject to change by the manufacturer without prior notice for product improvement purposes.

Control Panel Features





Following are instructions for starting and using your new dryer. Please refer to specific sections of this manual for more detailed information.

⚠️ WARNING

To reduce the risk of fire, electric shock, or injury to persons, read this entire manual, including the Important Safety Instructions, before operating this dryer.

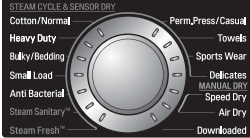

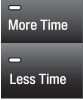
Operation

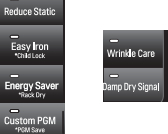
Button	Description
	<ul style="list-style-type: none"> • Power On/Off Button <ul style="list-style-type: none"> - Press to turn the dryer On. Press again to turn the dryer Off. NOTE : Pressing the On/Off button during a cycle will cancel that cycle and any load settings will be lost.
	<ul style="list-style-type: none"> • Cycle Selector Knob <ul style="list-style-type: none"> - Turn this knob to select the desired cycle. Once the desired cycle has been selected, the standard presets will be shown in the display. On Manual Dry cycles, these settings can be adjusted using the cycle setting buttons anytime before starting the cycle.
	<ul style="list-style-type: none"> • Start/Pause Button <ul style="list-style-type: none"> - Press this button to Start the selected cycle. If the dryer is running, use this button to Pause the cycle without losing the current settings. NOTE : If you do not press the Start/Pause button to resume a cycle within 4 minutes, the dryer turns off automatically.
	<ul style="list-style-type: none"> • More Time/Less Time Buttons <ul style="list-style-type: none"> - To adjust the drying time, use these buttons with Manual Dry, Time Dry, and Steam Fresh™ cycles, as well as the Reduce Static and Easy Iron options. Press the More Time button to increase the selected manual cycle time by a minute; press Less Time to decrease the cycle time by a minute.
	<ul style="list-style-type: none"> • Cycle Setting Buttons <ul style="list-style-type: none"> - Use these buttons to select the desired cycle settings for the selected cycle. The current settings are shown in the display. Press the button for that option to view and select other settings.
	<ul style="list-style-type: none"> • Option Buttons <ul style="list-style-type: none"> - The Option buttons allow you to select additional cycle options. Certain buttons also allow you to activate special functions by pressing and holding the button for 3 seconds.
<p>Steam Sanitary™</p> <p>Steam Fresh™</p>	<ul style="list-style-type: none"> • Steam Functions <ul style="list-style-type: none"> - LG's steam technology allows you to inject fabrics with a swirling jet of hot steam to refresh clothes, reduce static, and make ironing easier. Simply select the Steam Fresh™ cycle, or you can add a Steam option to selected cycles.







Display

The display shows the settings, estimated time remaining, options, and status messages for your dryer. When the dryer is turned on, the light in the display will illuminate.

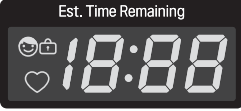
WARNING

To reduce the risk of fire, electric shock, or injury to persons, read this entire manual, including the Important Safety Instructions, before operating this dryer.



Button	Description
	<p>• Estimated Time Remaining</p> <p>- When the Start/Pause button is pressed, the dryer will display the estimated (Sensor Dry) or set time (Time Dry) remaining, and begin tumbling.</p> <p>NOTE : The cycle time on Sensor Dry cycles may fluctuate as the dryer recalculates drying time for optimal results</p>
	<p>• Cycle Completion Indicator With Check Filter Reminder</p> <p>- This portion of the display shows which stage of the drying cycle is currently underway (Clean Filter, Drying, or Cooling).</p>
	<p>• Child Lock Indicator</p> <p>- When Child Lock is set, the Child Lock indicator will appear and all buttons are disabled except the Power button. This prevents children from changing settings while the dryer is operating</p>
	<p>• Clean Filter Reminder</p> <p>- The display will show Clean Filter when the dryer is turned on as a reminder to check the filter. It turns off when the Start/Pause button is pressed.</p>
	<p>• Custom Program</p> <p>- If you have a special combination of settings that you use frequently, you can save these settings as a Custom Program.</p>
	<p>• Flow Sense™ Duct Blockage Sensing System Indicator</p> <p>- The Flow Sense™ duct blockage sensing system detects and alerts you to blockages in the ductwork that reduce exhaust flow from the dryer. This improves operating efficiency and helps minimize service calls, saving your money.</p>

INSTALLATION INSTRUCTIONS

Preview Installation Order

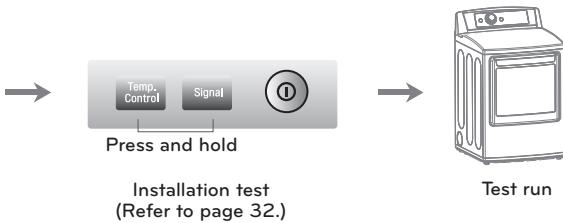
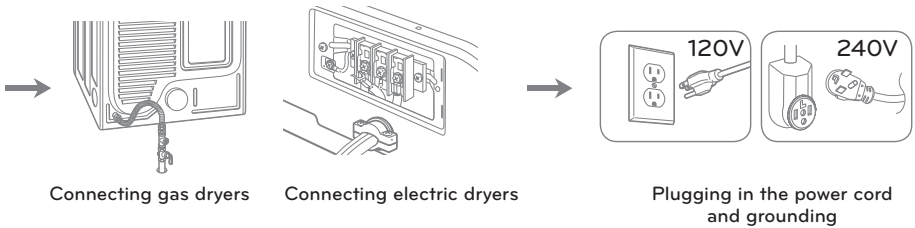
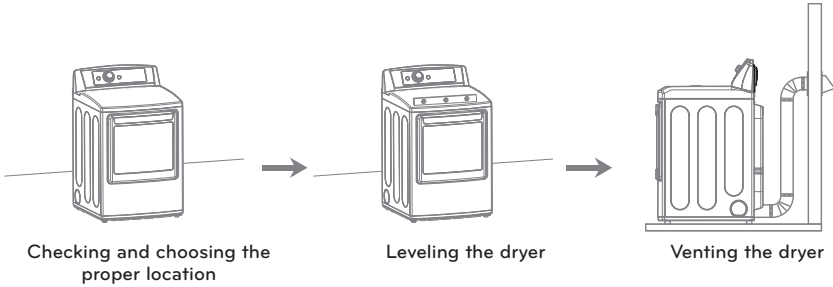

Installation Location Requirements

⚠ WARNING

Read all installation instructions completely before installing and operating your dryer! It is important that you review this entire manual before installing and using your dryer. Detailed instructions concerning electrical connections, gas connections, and exhaust requirements are provided on the following pages.

- A location that allows for proper exhaust installation. A gas dryer must be exhausted to the outdoors. See **Venting the dryer**.
- A sturdy floor to support the total dryer weight of 200 lbs (90.7 kg). The combined weight of a companion appliance should also be considered.
- A grounded electrical outlet located within 2 ft. (61 cm) of either side of the dryer. See **Connecting electric dryers**.
- No other fuel-burning appliance can be installed in the same closet as a dryer.

Do not operate your dryer at temperatures below 45°F (7°C). At lower temperatures, the dryer might not shut off at the end of an automatic cycle. This can result in longer drying times. The dryer must not be installed or stored in an area where it will be exposed to water and/or weather. Check code requirements. Some codes limit, or do not permit, installation of the dryer in garages, closets, mobile homes or sleeping quarters. Contact your local building inspector.

! NOTE

- A level floor with a maximum slope of 1 inch (2.5 cm) under entire dryer. If slope is greater than 1 inch (2.5 cm), install the Extended Dryer Feet Kit. Clothes may not tumble properly, and automatic sensor cycles may not operate correctly if dryer is not level.
- For a garage installation, you will need to place the dryer at least 18 inches (46 cm) above the floor. If using a pedestal, you will need 18 inches (46 cm) to the bottom of the dryer.

Clearances

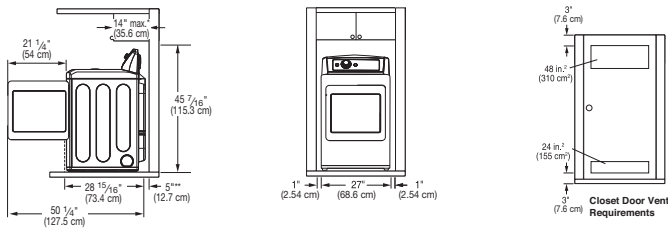

Installation Spacing For Recessed Area Or Closet Installation

The following spacing dimensions are recommended for this dryer. This dryer has been tested for spacing of 1 inch (2.54cm) clearance on the sides and rear. Recommended spacing should be considered for the following reasons:

- Additional spacing should be considered for ease of installation and servicing.
 - Additional clearances might be required for wall, door and floor moldings.
 - Additional spacing should be considered on all sides of the dryer to reduce noise transfer.
- For closet installation, with a door, minimum ventilation openings in the top and bottom of the door are required. Louvered doors with equivalent ventilation openings are acceptable.
- Companion appliance spacing should also be considered.

! NOTE

There should be at least a little space around the dryer (or any other appliance) to eliminate the transfer of vibration from one to the other. Too much vibration, it could cause them to make noise or touch each other causing paint damage and making even more noise.

Clearances (cont.)

Recommended Installation Spacing For Cabinet Installation

- For cabinet installation with a door, minimum ventilation openings in the top of the cabinet are required.

*Required spacing

**For side or bottom venting,
2 inches (5.1 cm) spacing is allowed.

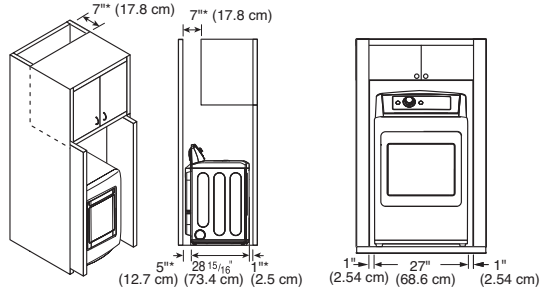

Leveling the Dryer

⚠ WARNING

• **To reduce the risk of injury to persons, adhere to all industry recommended safety procedures including the use of long sleeved gloves and safety glasses.**

Failure to follow this warning can cause serious injury or death.

• **The appliances are heavy. Two or more people are required when installing the dryer.** Failure to follow this warning can cause serious injury or death.

To ensure that the dryer provides optimal drying performance, it must be level. To minimize vibration, noise, and unwanted movement, the floor must be a perfectly level, solid surface.

! NOTE

Adjust the leveling feet only as far as necessary to level the dryer. Extending the leveling feet more than necessary can cause the dryer to vibrate.

1. Position the dryer in the final location. Place a level across the top of the dryer.

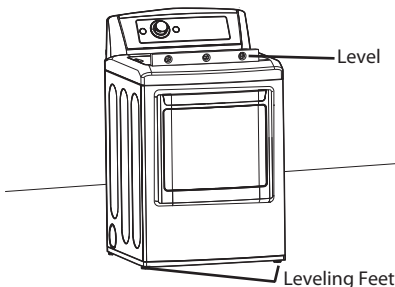

- All four leveling feet must rest solidly on the floor. Gently push on the top corners of the dryer to make sure that the dryer does not rock from corner to corner.

If you are installing the dryer on the optional pedestal, you must use the leveling feet on the pedestal to level the dryer. The dryer leveling feet should be fully retracted.

2. Use an adjustable wrench to turn the leveling feet. Turn clockwise to raise the dryer or counterclockwise to lower it. Raise or lower the leveling feet until dryer is level from side to side and front to back.

Make sure that all 4 leveling feet are in firm contact with the floor.

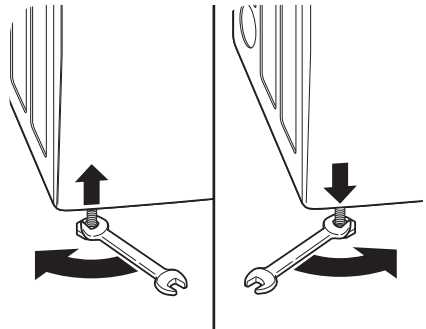

Reversing the Door

Before you begin

NOTE

The door reversal procedure for the two-way door is far more complex than for a conventional dryer door. It is recommended that you read through these instructions in their entirety before beginning the process, in order to gauge whether you prefer to have the procedure done by a professional installer or service person.

The door reversal procedure consists of four main parts:

- Removing and reinstalling the **door and hinges** (steps 1, 2 and 20)
- Removing and reversing components on the dryer **cabinet** (step 3)
- Removing and reversing components on the **door cover** (steps 4 and 5)
- Removing and reversing components **inside the door** (steps 6 through 19).

Tools Required

- **Phillips screwdriver**
- **Large flat blade screwdriver** (recommended for hinge screws if they are tight or your Phillips screwdriver is worn)
- **Small flat blade screwdriver** (for lifting out parts)

WARNING

- **To avoid damage to the dryer or the door, support the door with a stool or box that fits under the door, or have an assistant support the weight of the door.**
- **Avoid dropping the door to avoid damage to the door or the floor.**
- **Unplug the dryer or turn off power at the main circuit breaker before beginning door reversal.**
- **THE DRYER DOOR IS VERY LARGE AND HEAVY. Failure to follow the instructions below can result in damage to the dryer, property damage or personal injury.**

Instructions

NOTE

The instructions here are for changing the door swing from a right to a left side hinge. If the door has been reversed, and it is necessary to change it back, use care when following these instructions. Some of the illustrations and the left/right references will be reversed, and you will need to read the instructions carefully.

WARNING

Be sure to support the weight of the door before removing the hinge screws.

1. **Open the door from the side so that the hinge screws are accessible.**

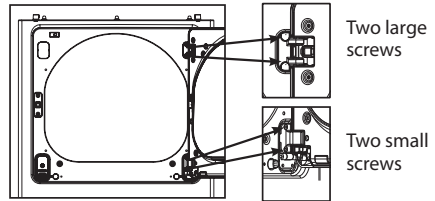

2. **Remove the four hinge screws.**

While supporting the door, remove the four hinge screws, two from each hinge. Set the door aside face down on a protected surface to prevent damage to the door or the work surface.

3. **Reverse the components on the cabinet.**

- a. Use a Phillips screwdriver to remove the two screws and the latch mechanism on the front panel of the cabinet.

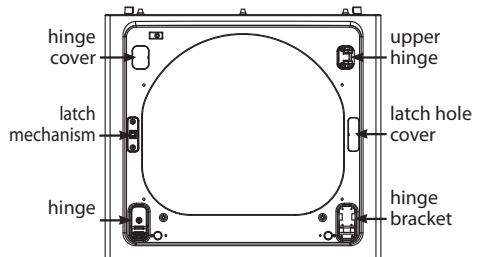

- b. Remove the latch hole cover by gently prying it up with a flat blade screwdriver, being careful not to scratch the paint. Install the latch hole cover on the opposite side, where the latch mechanism was removed. Install the latch mechanism in the position from which you removed the latch hole cover, using the two screws removed in step a.
- c. Remove the hinge cover by gently prying it up with a flat blade screwdriver, being careful not to scratch the paint. Rotate the hinge cover 180 degrees and install it on the opposite side, where the upper hinge was attached.

Reversing the Door (continued)

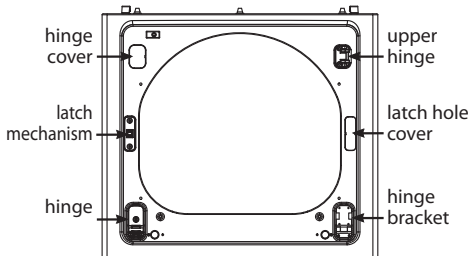

- d. Reverse the hinge and the hinge bracket at the bottom of the cabinet. Remove the two screws from the hinge bracket at bottom right and remove the hinge bracket. Remove the lower of the two screws behind the hinge bracket. Do NOT remove the upper screw behind the hinge bracket. Set the parts aside.

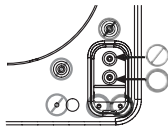

NOTE

Do **NOT** remove any of the eight screws on the face of the cabinet (marked with  below). Doing so could result in damage to the dryer and the need for a service call to repair the dryer.

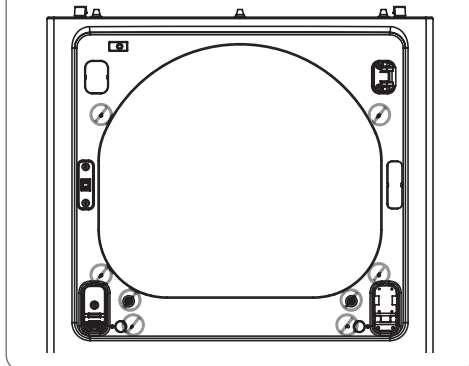

- e. Remove the three screws on the hinge at bottom left. Remove the hinge and reinstall it on the right side. The top screw occupies the hole where you removed the screw behind the hinge bracket in step d.

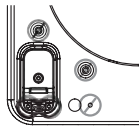

- f. Install the hinge bracket removed in step d on the bottom left side, first installing one screw behind the hinge bracket.

ON THE DOOR:

4. Lift off the door cover.

With the door laid inside facing up on a protected surface, remove the 12 screws on the inside of the door. Carefully lift off the door cover with the help of a small flat blade screwdriver inserted in the upper corner (circled below).

WARNING

The edges of the door cover may be sharp. Take care when handling, or wear gloves to avoid injury.

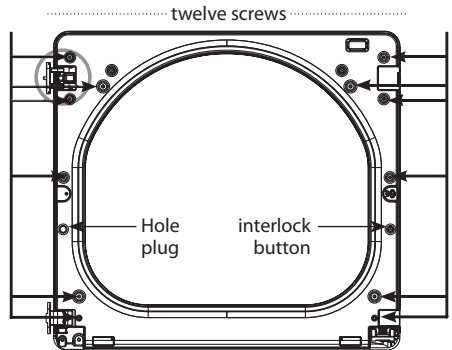

5. Switch the door strike and the blank cover.

Remove the four screws on the door cover that secure the door strike and the blank cover.

Switch the door strike and the blank cover, installing them on the opposite sides from which they were removed.

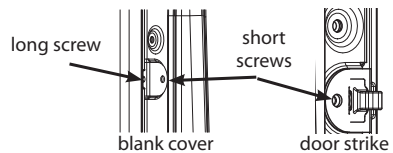

Gently pry out the hole plug on the side of the door cover and install it in the hole on the opposite side.

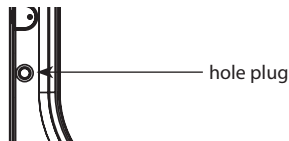

Set the door cover aside.

Reversing the Door (continued)

6. Reverse the components inside the door.

You will now be removing and reversing various components inside the door. See below for a detailed diagram and identification of the inner structure and parts of the door. (The diagram shows the "before view" of the door, with the default set-up for a right side hinge swing. After following these instructions, your door should be a mirror image of the illustration.)

**Inner Structure of Door
(before reversing - right hinge swing)**

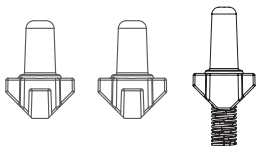
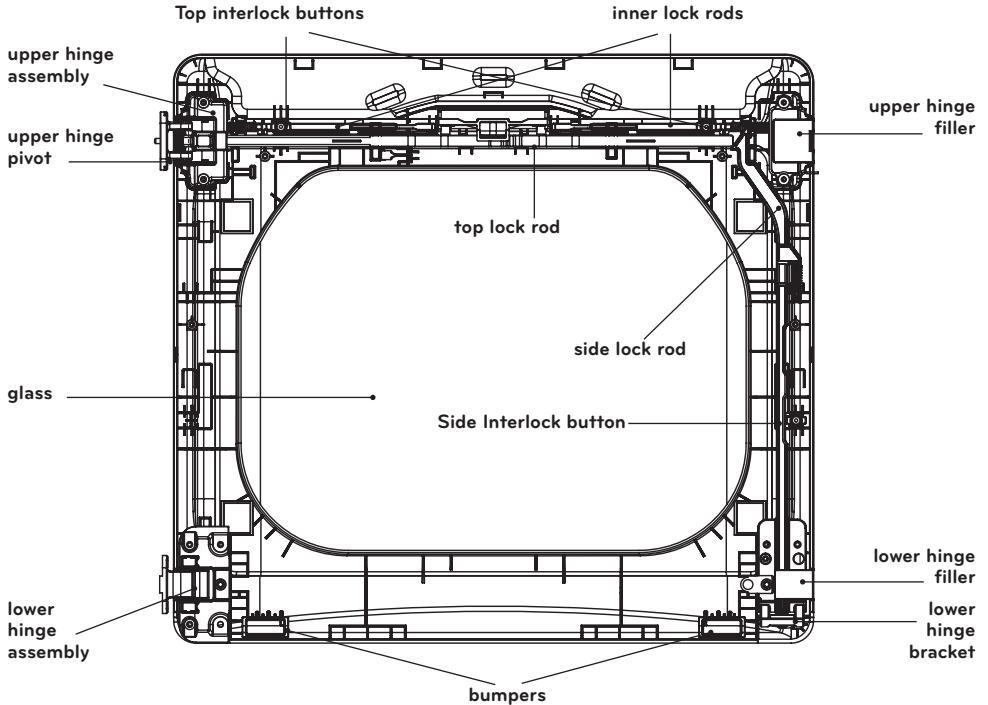

interlock buttons

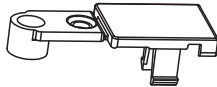

lower hinge filler



side lock rod



top lock rod

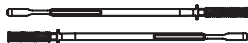

inner lock rods



lower hinge bracket

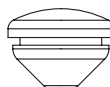

Hole plug

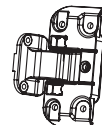

lower hinge assembly

Reversing the Door (continued)

7. Lift out the two top interlock buttons.

Lift out the two grey interlock buttons from the top of the outer door and set them aside for later use.

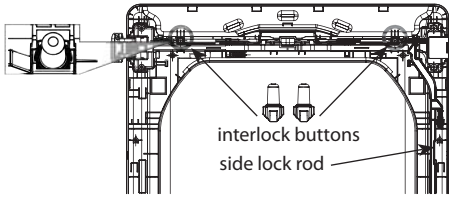

8. Lift out the grey interlock button in the side of the door.

Make sure to remove the spring with the interlock button and to keep them together. Set the interlock button aside. Do not confuse with interlock buttons from the top of the outer door.

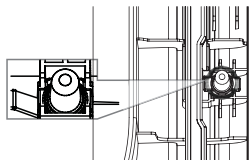

9. Remove the side lock rod.

Remove the side lock rod from the lower hinge bracket by lifting the top end of the rod and sliding it toward the top of the door. The spring should remain attached to the lock rod. Set the lock rod aside.

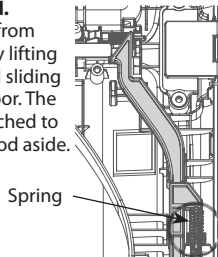

10. Remove the top lock rod.

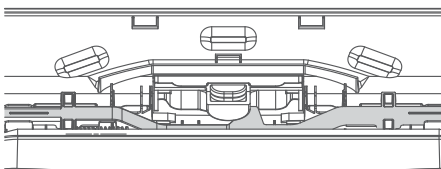

a. Slide the lock rod to the right to remove it from the hinge assembly on the left side.

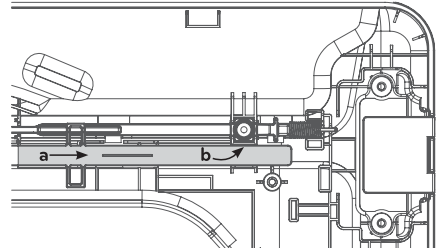

b. While sliding the lock rod right, lift the right end up and out of the guides.

NOTE

Do not remove the two inner lock rods (see page 17) located underneath the top lock rod. They do NOT need to be reversed

11. Remove the upper hinge pivot.

Once the top lock rod has been removed, the hinge pivot can easily be removed from the hinge assembly on the upper left and set aside.

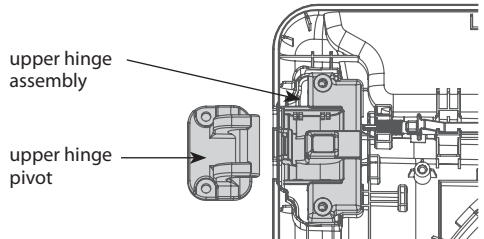

12. Reverse the upper hinge assembly and hinge filler.

Lift out the upper hinge filler (on the right) and set it aside.

Carefully lift the upper hinge assembly (on the left) out of the outer door frame, using a small flat blade screwdriver if necessary. Rotate the hinge assembly 180 degrees and install it on the upper right side of the outer door. You will need to press firmly to install the hinge assembly.

The hinge pivot removed in step 11 will be installed later.

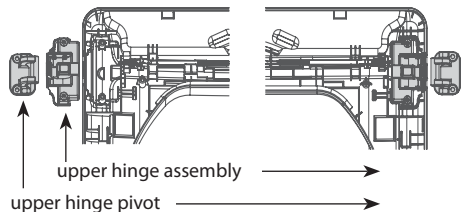

Reversing the Door (continued)

Now rotate the hinge filler 180 degrees and install it on the upper left side of the door.

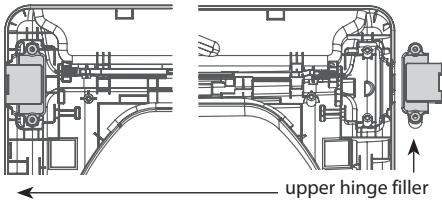

13. Reinstall the top lock rod.

Rotate the top lock rod (removed in step 10) 180 degrees end for end from its original position and reinstall it. The spring should now be to the right of center, with the spring on the side of the rod facing the top of the door.

- a. Insert the right end of the lock rod into the right hinge assembly. Make sure the rod is aligned with the guides in the door panel.

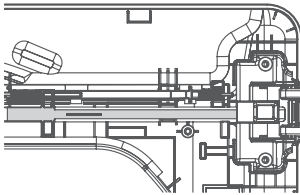

- b. Lower the rod into position, sliding it to bypass the center handle, making sure to align the lock rod with the guides all the way across the door panel. When released, the lock rod should slide completely into the hinge assembly on the right. Slide the lock rod back and forth to make sure it is correctly positioned in the guides and slides easily.

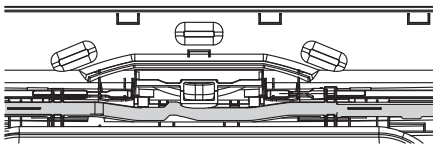

14. Reverse the lower hinge bracket and hinge assembly.

- a. Remove the screw from the lower hinge bracket (on the right) and lift the hinge bracket out. Set it aside. Remove the two screws from the lower hinge assembly on the bottom left and lift the hinge assembly out.

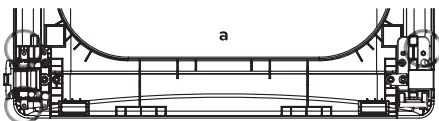

- b. Rotate the lower hinge assembly 180 degrees and install it on the right side using the two screws removed in step a.

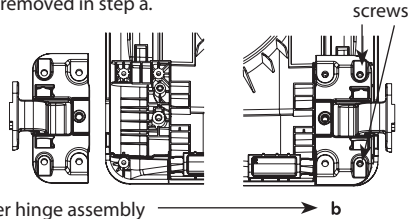

lower hinge assembly

b

- c. Flip over the lower hinge bracket and release the tabs on the back locking the hinge filler to the hinge bracket.

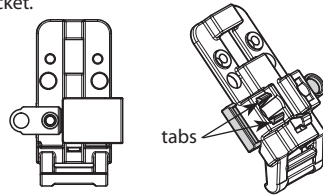

- d. Rotate the hinge filler 180 degrees and snap it back onto the FRONT of the hinge bracket facing in the opposite direction.

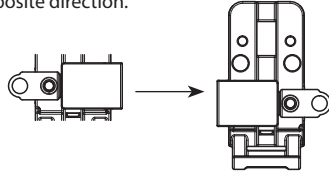

- e. Mount the lower hinge bracket and the filler on the left side of the door with the screw removed in step a.

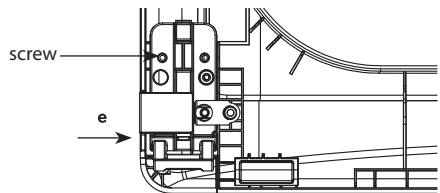

15. Install the side lock rod.

Flip the side lock rod over and install it on the opposite side. Insert the lower end into the left hinge and lower the rod into the guides on the door while compressing the spring inside the recess.

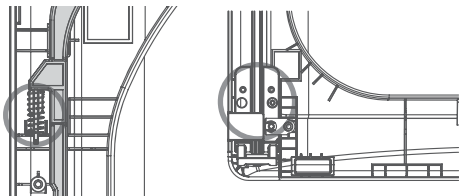

Reversing the Door (continued)

Make sure the top of the side lock rod is beside the top lock rod and the two do not overlap each other, so the two rods can interact correctly. If they are not aligned properly, the door will not operate properly.

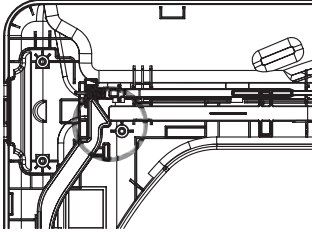

16. Reinstall the top interlock buttons.

Reinstall the top gray interlock buttons removed in step 7, one on each side of the outer door panel.

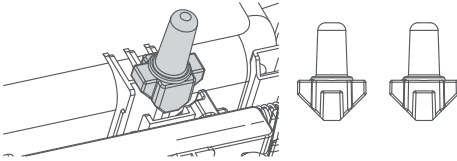

17. Reinstall the side interlock button.

Reinstall the side interlock button removed in step 8. Center the spring in the compartment and insert the interlock button on top of it.

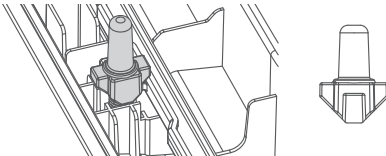

18. Reinstall the door cover.

Clean the glass on the door and door cover, if necessary.

Make sure the three gray interlock buttons are properly installed and that the top and side lock rods are properly aligned where they meet. Carefully lower the door cover into place, aligning the holes in the cover with the interlock buttons on the top and side and the bumpers on the bottom. Take care not to dislodge the lock rods while mounting the door cover. Once the door cover is in place, secure it with the 12 screws removed in step 4.

The ten similar screws go around the top and sides of the door cover. Make sure to install the two different screws on the bottom edge, in the locations marked below

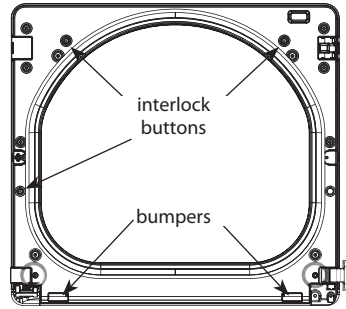

19. Now, pick up the upper hinge pivot removed earlier and rotate it 180 degrees.

Press in the side interlock button on the left side and hold it down while you press the hinge pivot into the hinge assembly on the top right side. If the door has been reassembled correctly, the lock rod will slide back easily and lock the pivot in place. The door is now ready to remount on the opposite side of the dryer.

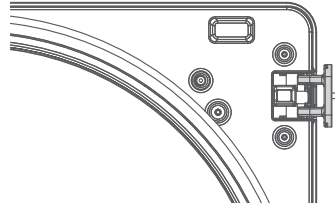

⚠ WARNING

Be sure to support the weight of the door before installing the hinge screws.

20. Reinstall the door.

While supporting the door, install the four hinge screws removed in step 2. Test the swing of the door to make sure the hinges and latch are properly aligned and that the door opens, closes and latches properly in both directions.

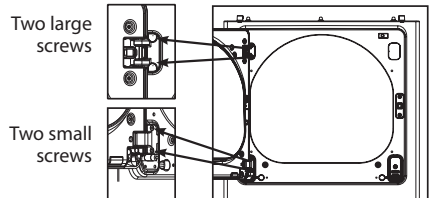

If the door doesn't operate smoothly, remove the door and then the door cover to check that the lock rods and interlock buttons are properly mounted and aligned. The interlock buttons should be oriented correctly and operating smoothly. The interlock rods should be in the proper position and should not overlap at the contact point. (See steps 13-15.)

If the door is damaged, or if the door does not work after reassembly, contact the call center at 1-800-243-0000.

Installing the Side Vent Kit

⚠ WARNING

- Use a heavy metal vent.
- Do not use plastic or thin foil duct.
- Clean old ducts before installing this dryer.
- To reduce the risk of injury to persons, adhere to all industry recommended safety procedures including the use of long sleeved gloves and safety glasses.
- Failure to follow all of the safety warnings in this manual could result in property damage, injury to persons, or death.

Your new dryer is shipped to vent to the rear. It can also be configured to vent to the bottom or side (right-side venting is not available on gas models).

An adapter kit, part number 383EEL9001B, may be purchased from your LG retailer. This kit contains the necessary duct components to change the dryer vent location.

1. Remove the rear exhaust duct retaining screw. Pull out the exhaust duct.

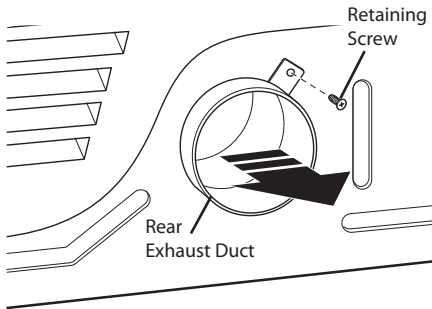

OPTION 1: SIDE VENTING

2. Press the tabs on the knockout and carefully remove the knockout for the desired vent opening (right-side venting is not available on gas models). Press the adapter duct onto the blower housing and secure to the base of the dryer as shown.

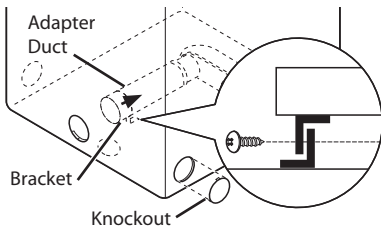

3. Preassemble a 4 inches (10.2 cm) elbow to the next 4-inches (10.2 cm) duct section, and secure all joints with duct tape. Be sure that the male end of the elbow faces AWAY from the dryer. Insert the elbow/duct assembly through the side opening and press it onto the adapter duct. Secure in place with duct tape. Be sure that the male end of the duct protrudes 1 2/4 inches (3.8 cm) to connect the remaining ductwork. Attach cover plate to the back of the dryer with included screw.

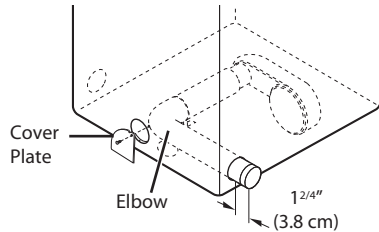

OPTION 2: BOTTOM VENTING

2. Press the adapter duct onto the blower housing and secure to the base of the dryer as shown.

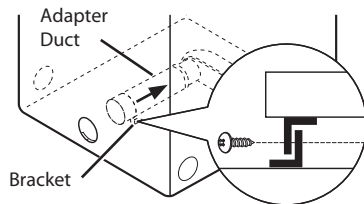

3. Insert the 4 inches (10.2 cm) elbow through the rear opening and press it onto the adapter duct. Be sure that the male end of the elbow faces down through hole in the bottom of the dryer. Secure in place with duct tape. Attach the cover plate to the back of the dryer with included screw.

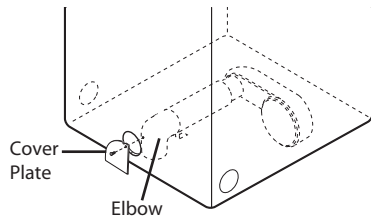

Venting the Dryer

WARNING

To reduce the risk of fire, electric shock, or injury to persons when using this appliance, follow basic precautions, including the following:

- **Do not crush or collapse ductwork.** Failure to follow these instructions can result in fire or death.
- **Do not allow ductwork to rest on or contact sharp objects.** Failure to follow these instructions can result in fire or death.
- **If connecting to existing ductwork, make sure it is suitable and clean before installing the dryer.** Failure to follow these instructions can result in fire or death.
- **Venting must conform to local building codes.** Failure to follow these instructions can result in fire or death.
- **Gas dryers MUST exhaust to the outdoors.** Failure to follow these instructions can result in fire or death.
- **Use only 4-inch (10.2 cm) rigid or flexible metal ductwork inside the dryer cabinet and for venting outside.** Failure to follow these instructions can result in fire or death.
- **To reduce the risk of fire, combustion, or accumulation of combustible gases, DO NOT exhaust dryer air into an enclosed and unventilated area, such as an attic, wall, ceiling, crawl space, chimney, gas vent, or concealed space of a building.** Failure to follow these instructions can result in fire or death.
- **To reduce the risk of fire, DO NOT exhaust the dryer with plastic or thin foil ducting.** Failure to follow these instructions can result in fire or death.
- **The exhaust duct must be 4 inches (10.2 cm) in diameter with no obstructions. The exhaust duct should be kept as short as possible. Make sure to clean any old ducts before installing your new dryer.** Failure to follow these instructions can result in fire or death.
- **Rigid or semirigid metal ducting is recommended for use between the dryer and the wall. In special installations when it is impossible to make a connection with the above recommendations, a UL-listed flexible metal transition duct may be used between the dryer and wall connection only. The use of this ducting will affect drying time.** Failure to follow these instructions can result in fire or death.
- **DO NOT use sheet metal screws or other fasteners which extend into the duct that could catch lint and reduce the efficiency of the exhaust system. Secure all joints with duct tape.** Failure to follow these instructions can result in fire or death.
- **Ductwork is not provided with the dryer. You should obtain the necessary ductwork locally. The end cap should have hinged dampers to prevent backdraft when the dryer is not in use.** Failure to follow these instructions can result in fire or death.
- **The total length of flexible metal duct shall not exceed 8 ft. (2.4 m).**
- **In Canada, only those foil-type flexible ducts, if any, specifically identified for use with the appliance by the manufacturer shall be used.** In the United States, only those foil-type flexible ducts, if any, specifically identified for use with the appliance by the manufacturer and that comply with the Outline for Clothes Dryer Transition Duct, Subject 2158A, shall be used.

Venting the Dryer (cont.)

Ductwork

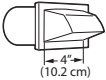
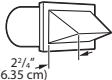
Wall Cap Type	Number Of 90° Elbows	Maximum Length Of 4-inch Diameter Rigid Metal Duct
 	0	65 ft. (19.8 m)
	1	55 ft. (16.8 m)
	2	47 ft. (14.3 m)
	3	36 ft. (11.0 m)
	4	28 ft. (8.5 m)
Use only for short run installations 	0	55 ft. (16.8 m)
	1	47 ft. (14.3 m)
	2	41 ft. (12.5 m)
	3	30 ft. (9.1 m)
	4	22 ft. (6.7 m)

Correct Venting

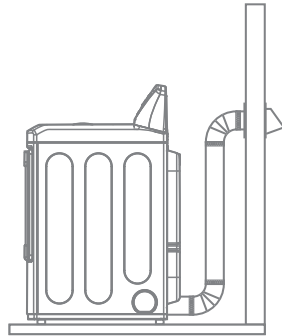

Incorrect Venting

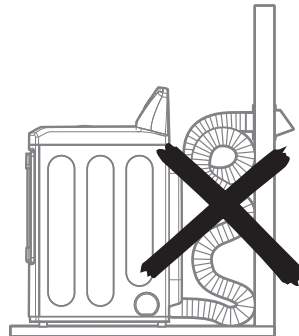

NOTE

Deduct 6 ft. (1.8 m) for each additional elbow. It is not recommended to use more than four 90° elbows.

Routing and Connecting Ductwork

NOTE

Follow the guidelines below to maximize drying performance and reduce lint buildup and condensation in the ductwork. Ductwork and fittings are NOT included and must be purchased separately.

- Use 4-inch (10.2 cm) diameter rigid or semirigid metal ductwork.
- The exhaust duct run should be as short as possible.
- Use as few elbow joints as possible.
- The male end of each section of exhaust duct must point away from the dryer.
- Use duct tape on all duct joints.
- Insulate ductwork that runs through unheated areas in order to reduce condensation and lint buildup on duct surfaces.
- Incorrect or inadequate exhaust systems are not covered by the dryer warranty. Failures or poor performance caused by such exhaust systems will not be covered by the dryer warranty.

Connecting Gas Dryers

WARNING

To reduce the risk of fire, electric shock, or injury to persons when using this appliance, follow basic precautions, including the following:

- **Gas supply requirements:**
As shipped from the factory, this dryer is configured for use with natural gas. It can be converted for use with LP (Liquefied Propane) gas. Gas pressure must not exceed 13 inches of water column.
- A qualified service or gas company technician must connect the dryer to the gas service.
Failure to do so can result in fire, explosion, or death.
- Isolate the dryer from the gas supply system by closing its individual manual shutoff valve during any pressure testing of the gas supply. Failure to do so can result in fire, explosion, or death.
- Supply line requirements:
Your laundry room must have a rigid gas supply line to your dryer. In the United States, an individual manual shutoff valve MUST be installed within at least 6 ft. (1.8 m) of the dryer, in accordance with the National Fuel Gas Code ANSI Z223.1 or Canadian gas installation code CSA B149.1. A $\frac{1}{8}$ - inch NPT pipe plug must be installed. Failure to do so can result in fire, explosion, death.
- If using a rigid pipe, the rigid pipe should be $\frac{1}{2}$ - inch IPS. If acceptable under local codes and ordinances and when acceptable to your gas supplier, $\frac{3}{8}$ - inch approved tubing may be used where lengths are less than 20 ft. (6.1 m). Larger tubing should be used for lengths in excess of 20 ft. (6.1 m). Failure to do so can result in fire, explosion, or death.
- Connect the dryer to the type of gas shown on the nameplate. Failure to do so can result in fire, explosion, or death.
- To prevent contamination of the gas valve, purge the gas supply of air and sediment before connecting the gas supply to the dryer. Before tightening the connection between the gas supply and the dryer, purge remaining air until the odor of gas is detected. Failure to do so can result in fire, explosion, or death.
- DO NOT use an open flame to inspect for gas leaks. Use a noncorrosive leak-detection fluid. Failure to do so can result in fire, explosion, or death.
- Use only a new AGA- or CSA-certified gas supply line with flexible stainless steel connectors. Failure to do so can result in fire, explosion, or death.
- Securely tighten all gas connections. Failure to do so can result in fire, explosion, or death.
- DO NOT attempt any disassembly of the dryer; any disassembly requires the attention and tools of an authorized and qualified service person or company. Failure to do so can result in fire, explosion, or death.
- Use a pipe-joint compound that is insoluble in Liquefied Petroleum (LP) gas on all pipe threads. Failure to do so can result in fire, explosion, or death.

Electrical requirements for gas models only

WARNING

To reduce the risk of fire, electric shock, or injury to persons when using this appliance, follow basic precautions, including the following:

- Do not, under any circumstances, cut or remove the third (ground) prong from the power cord. Failure to follow this warning can result in fire, explosion, or death.
- For personal safety, this dryer must be properly grounded. Failure to follow this warning can result in fire, explosion, or death.
- The power cord of this dryer is equipped with a 3-prong (grounding) plug which mates with a standard 3-prong (grounding) wall outlet to minimize the possibility of electric shock hazard from this appliance. Failure to follow this warning can result in fire, explosion, or death.
- This dryer must be plugged into a 60 Hz, 120 VAC, grounded outlet protected by a 15-ampere fuse or circuit breaker. Failure to follow this warning can result in fire, explosion, or death.
- Where a standard 2-prong wall outlet is encountered, it is your personal responsibility and obligation to have it replaced with a properly grounded 3-prong wall outlet. Failure to follow this warning can result in fire, explosion, or death.

Connecting Gas Dryers (cont.)

⚠️ WARNING

To reduce the risk of fire, electric shock, or injury to persons when using this appliance, follow basic precautions, including the following:

- **Installation and service must be performed by a qualified installer, service agency, or the gas supplier.** Failure to do so can result in fire, explosion, or death.
- **Use only a new stainless steel flexible connector and a new AGA-certified connector.** Failure to do so can result in fire, explosion, or death.
- **A gas shutoff valve must be installed within 6 ft. (1.8 m) of the dryer.** Failure to do so can result in fire, explosion, or death.
- **The dryer is configured for Natural Gas when shipped from the factory. Make sure that the dryer is equipped with the correct burner orifice for the type of gas being used (Natural Gas or Liquefied Petroleum).** Failure to do so can result in fire, explosion, or death.
- **If necessary, the correct orifice (For the LP orifice kit, order part number 383EEL3002D) should be installed by a qualified technician and the change should be noted on the dryer.** Failure to do so can result in fire, explosion, or death.
- **All connections must be in accordance with local codes and regulations.** Failure to do so can result in fire, explosion, or death.
- **Gas dryers MUST exhaust to the outdoors.** Failure to do so can result in fire, explosion, or death.

Connecting the gas supply

1. Make sure that the gas supply to the laundry room is turned OFF. Confirm that the type of gas available in your laundry room is appropriate for the dryer. The dryer is prepared for Natural Gas with a $\frac{3}{8}$ - inch NPT gas connection.
2. Remove the shipping cap from the gas connection at the back of the dryer. Be careful not to damage the threads of the gas connector when removing the shipping cap.
3. Connect the dryer to your laundry room's gas supply using a new flexible stainless steel connector with a $\frac{3}{8}$ - inch NPT fitting.
4. Securely tighten all connections between the dryer and your laundry room's gas supply. Turn on your laundry room's gas supply and check all pipe connections (both internal and external) for gas leaks with a noncorrosive leak-detection fluid.

Electrical connection

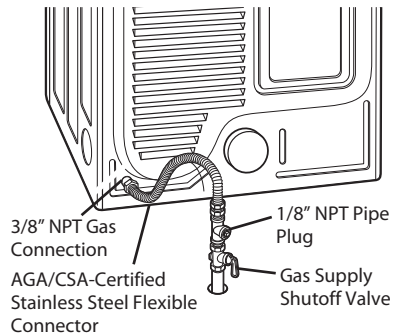
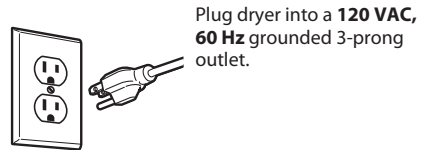

High-altitude installations

The BTU rating of this dryer is AGA-certified for elevations below 10,000 feet.

If your gas dryer is being installed at an elevation above 10,000 feet, it must be derated by a qualified technician or gas supplier.

Connecting Electric Dryers

WARNING

To help prevent fire, electric shock, serious injury, or death, the wiring and grounding must conform to the latest edition of the National Electrical Code, ANSI/NFPA 70 and all applicable local regulations. Please contact a qualified electrician to check your home's wiring and fuses to ensure that your home has adequate electrical power to operate the dryer.

Electrical requirements for electric models only

WARNING

To reduce the risk of fire, electric shock, or injury to persons when using this appliance, follow basic precautions, including the following:

- **This dryer must be connected to a grounded metal, permanent wiring system, or an equipment-grounding conductor must be run with the circuit conductors and connected to the equipment-grounding terminal or lead on the dryer.** Failure to do so can result in fire, explosion, or death.
- **The dryer has its own terminal block that must be connected to a separate 240 VAC, 60-Hertz, single-phase circuit, fused at 30 amperes (the circuit must be fused on both sides of the line). ELECTRICAL SERVICE FOR THE DRYER SHOULD BE OF THE MAXIMUM RATE VOLTAGE LISTED ON THE NAMEPLATE. DO NOT CONNECT DRYER TO 110-, 115-, OR 120-VOLT CIRCUIT.** Failure to follow these instructions can result in fire, explosion, or death.
- **If branch circuit to dryer is 15 ft. (4.5 m) or less in length, use UL (Underwriters Laboratories) listed No.-10 AWG wire (copper wire only), or as required by local codes. If over 15 ft. (4.5 m), use UL-listed No.-8 AWG wire (copper wire only), or as required by local codes. Allow sufficient slack in wiring so dryer can be moved from its normal location when necessary.** Failure to do so can result in fire, explosion, or death.
- **The power cord (pigtail) connection between wall receptacle and dryer terminal block IS NOT supplied with dryer. Type of pigtail and gauge of wire must conform to local codes and with instructions on the following pages.** Failure to follow these instructions can result in fire, explosion, or death.
- **A 4-wire connection is required for all mobile and manufactured home installations, as well as all new construction after January 1, 1996. A 4-wire connection must be used where local codes do not permit grounding through the neutral wire.** Failure to do so can result in fire, explosion, or death.

WARNING

To reduce the risk of fire, electric shock, or injury to persons when using this appliance, follow basic precautions, including the following:

- **Do not modify the plug and internal wire provided with the dryer.**
- **The dryer should be connected to 4-hole outlet.**
- **If it does not fit the outlet, a proper outlet will need to be installed by a qualified electrician.**

WARNING

To reduce the risk of fire, electric shock, or injury to persons when using this appliance, follow basic precautions, including the following:

- **Any installation in a manufactured or mobile home must comply with the Manufactured Home Construction and Safety Standards Title 24 CFR, Part 3280 or Standard CAN/ CSA Z240 MH and local codes and ordinances.**
- **A 4-wire connection is required for all mobile and manufactured home installations, as well as all new construction after January 1, 1996.** Failure to do so can result in fire, explosion, or death.

Connecting Electric Dryers (cont.) USA only

⚠️ WARNING

• Connect the power cord to the terminal block. Connect each power cord wire to the terminal block screw that has the same colored wire. For example, connect the black power cord wire to the terminal block screw with the black wire. Failure to follow these instructions may result in a short, overload, fire or death.

• Grounding through the neutral conductor is prohibited for: (1) new branch-circuit installations, (2) mobile homes, (3) recreational vehicles, and (4) areas where local codes prohibit grounding through the neutral conductor.



Four-wire connection for electric dryers: Power cord

- A 4-wire connection is required for all mobile and manufactured home installations, as well as all new construction after January 1, 1996.
- A UL-listed strain relief is required.

1. Remove the terminal block access cover on the upper back of the dryer. Install a UL-listed strain relief into the power cord through-hole; then thread a UL-listed, **30 A, 240 V, 4-wire, #10 AWG-minimum copper** conductor power cord through the strain relief.

• Use a **30 A, 240 V, UL-listed power cord with #10 AWG-minimum copper** conductor and closed loop or forked terminals with upturned ends.

2. Transfer the dryer's ground wire from behind the green ground screw to the center screw of the terminal block. Attach the two hot leads of the power cord to the outer terminal block screws. Attach the white neutral wire to the center terminal block screw. Attach the power cord ground wire to the green ground screw. **TIGHTEN ALL SCREWS SECURELY.** Reinstall the terminal block access cover.

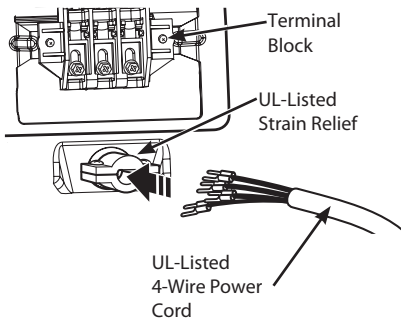
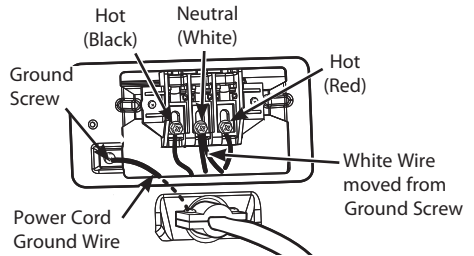

Connecting Electric Dryers (cont.)

USA only

⚠ WARNING

- **Connect the power cord to the terminal block. Connect each power cord wire to the terminal block screw that has the same colored wire. For example, connect the black power cord wire to the terminal block screw with the black wire. Failure to follow these instructions may result in a short, overload, fire or death.**
- **Grounding through the neutral conductor is prohibited for: (1) new branch-circuit installations, (2) mobile homes, (3) recreational vehicles, and (4) areas where local codes prohibit grounding through the neutral conductor.**

Four-wire connection for electric dryers: Direct wire

- A 4-wire connection is required for all mobile and manufactured home installations, as well as all new construction after January 1, 1996.
 - A UL-listed strain relief is required.
1. Remove 5 inches (12.7 cm) of the outer covering from the wire. Remove 5 inches of insulation from the ground wire. Cut off approximately 1½ inches (3.8 cm) from the other three wires and strip 1 inch (2.5 cm) insulation from each wire. Bend the ends of the three shorter wires into a hook shape.

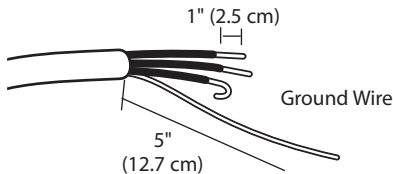

2. Remove the terminal block access cover on the upper back of the dryer. Install a UL-listed strain relief into the power cord through-hole; then thread the power cable prepared in Step 1 through the strain relief.

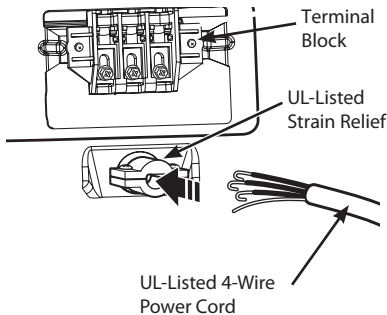

- Use UL-listed **4-wire #10 AWG-minimum copper** conductor cable.
 - Allow at least 5 ft. (1.5 m) length to allow for removal and reinstallation of the dryer.
3. Transfer the dryer's ground wire from behind the green ground screw to the center screw of the terminal block. Attach the two hot leads of the power cable to the outer terminal block screws. Attach the white neutral wire to the center terminal block screw. Attach the power cable ground wire to the green ground screw. **TIGHTEN ALL SCREWS SECURELY.** Reinstall the terminal block access cover.

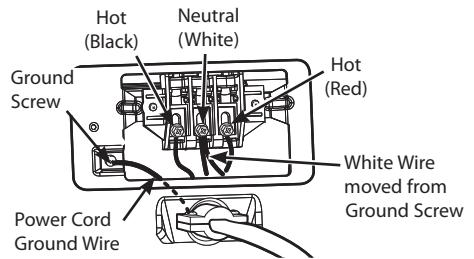

Connecting Electric Dryers (cont.) USA only

⚠ WARNING

• **Connect the power cord to the terminal block. Connect each power cord wire to the terminal block screw that has the same colored wire. For example, connect the black power cord wire to the terminal block screw with the black wire. Failure to follow these instructions may result in a short, overload, fire or death.**

• **Grounding through the neutral conductor is prohibited for: (1) new branch-circuit installations, (2) mobile homes, (3) recreational vehicles, and (4) areas where local codes prohibit grounding through the neutral conductor.**



**Three-wire connection for electric dryers:
Power cord**

- A 3-wire connection is NOT permitted on new construction after January 1, 1996.
 - A UL-listed strain relief is required.
1. Remove the terminal block access cover on the upper back of the dryer. Install a UL-listed strain relief into the power cord through-hole; then thread a UL-listed, **30 A, 240 V, 3-wire, #10 AWG-minimum copper** conductor power cord through the strain relief.

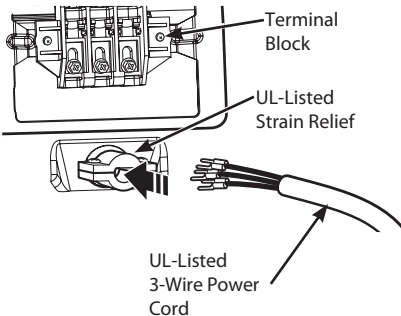

- Use a **30 A, 240 V, UL-listed power cord with #10 AWG-minimum copper** conductor and closed loop or forked terminals with upturned ends.
2. Attach the two hot leads of the power cord to the outer terminal block screws. Attach the neutral wire to the center terminal block screw. Connect the external ground (if required by local codes) to the green ground screw. **TIGHTEN ALL SCREWS SECURELY.** Reinstall the terminal block access cover.

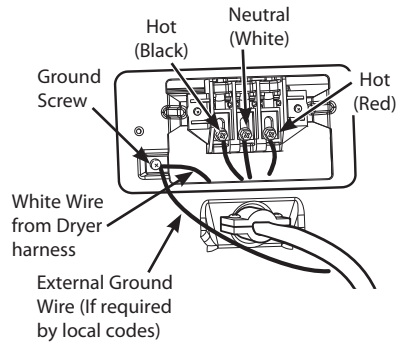

Connecting Electric Dryers (cont.)

USA only

⚠ WARNING

• **Connect the power cord to the terminal block. Connect each power cord wire to the terminal block screw that has the same colored wire. For example, connect the black power cord wire to the terminal block screw with the black wire. Failure to follow these instructions may result in a short, overload, fire or death.**

• **Grounding through the neutral conductor is prohibited for: (1) new branch-circuit installations, (2) mobile homes, (3) recreational vehicles, and (4) areas where local codes prohibit grounding through the neutral conductor.**

Three-wire connection for electric dryers: Direct wire

• A 3-wire connection is NOT permitted on new construction after January 1, 1996.

• A UL-listed strain relief is required.

1. Remove $3\frac{1}{2}$ inches (8.9 cm) of the outer covering from the wire. Strip 1 inch (2.5 cm) insulation from each wire. Bend the ends of the three wires into a hook shape.



2. Remove the terminal block access cover on the upper back of the dryer. Install a UL-listed strain relief into the power cord through-hole; then thread the power cable prepared in Step 1 through the strain relief.

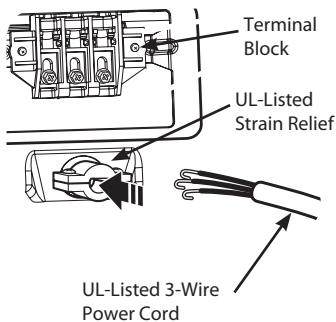

- Use UL-listed **3-wire #10 AWG-minimum copper** conductor cable.
 - Allow at least 5 ft. (1.5 m) length to allow for removal and reinstallation of the dryer.
3. Attach the two hot leads of the power cord to the outer terminal block screws. Attach the neutral wire to the center terminal block screw. Connect the external ground (if required by local codes) to the green ground screw. **TIGHTEN ALL SCREWS SECURELY.** Reinstall the terminal block access cover.

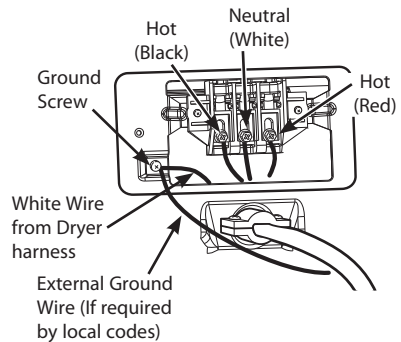

Special Requirements for Manufactured or Mobile Homes

Any installation in a manufactured or mobile home must comply with the Manufactured Home Construction and Safety Standards Title 24 CFR, Part 3280 or Standard CAN/CSA Z240 MH and local codes and ordinances. If you are uncertain whether your proposed installation will comply with these standards, please contact a service and installation professional for assistance.

- A gas dryer must be permanently attached to the floor.
- The electrical connection for an electric dryer must be a 4-wire connection. More detailed information concerning the electrical connection is provided in the section Connecting Electric Dryers.
- To reduce the risk of combustion and fire, the dryer must be vented to the outside.
- DO NOT vent the dryer under a manufactured home or mobile home.
- Electric dryers may be vented to the outside using the back, left, right, or bottom panel.
- Gas dryers may be vented to the outside using the back, left, or bottom panel. Gas dryers may not be vented to the outside using the right side panel because of the burner housing.
- The dryer exhaust duct must be affixed securely to the manufactured or mobile home structure, and the exhaust duct must be made of a material that will resist fire and combustion.
It is recommended that you use a rigid or flexible metal duct.
- DO NOT connect the dryer exhaust duct to any other duct, vent, chimney, or other exhaust duct.
- Make sure the dryer has adequate access to outside fresh air to ensure proper operation. The opening for outside fresh air must be at least 25 in² (163 cm²).
- It is important that the clearance of the duct from any combustible construction be at least 2 inches (5 cm), and when venting the dryer to the outdoors, the dryer can be installed with a clearance of 1 inch (2.5 cm) at the sides and back of the dryer.
- Please be aware that venting materials are not supplied with the dryer. You should obtain the venting materials necessary for proper installation.

Final Installation Check

Once you have completed the installation of the dryer and it is in its final location, confirm proper operation with the following tests and Installation Test (Duct Check) on the following page.

Testing dryer heating

GAS MODELS

Close the dryer door, press the On/Off button to turn the dryer on, and start the dryer on a heat setting. When the dryer starts, the igniter should ignite the main burner.

NOTE

If all air is not purged from the gas line, the gas igniter may turn off before the main burner ignites. If this happens, the igniter will reattempt gas ignition after approximately two minutes.

ELECTRIC MODELS

Close the dryer door, press the On/Off button to turn the dryer on, and start the dryer on a heat setting. The exhaust air should be warm after the dryer has been operating for 3 minutes.

Checking airflow

Effective dryer operation requires proper airflow. The adequacy of the airflow can be measured by evaluating the static pressure. Static pressure in the exhaust duct can be measured with a manometer, placed on the exhaust duct approximately 2 ft. (60.9 cm) from the dryer. Static pressure in the exhaust duct should not exceed 0.6 inches (1.5 cm). The dryer should be checked while the dryer is running with no load.

Checking levelness

Once the dryer is in its final location, recheck the dryer to be sure it is level. Make sure it is level front to back and side to side, and that all 4 leveling feet are firmly on the floor.

Installation Test (Duct check)

Once you have completed the installation of the dryer, use this test to make sure the condition of the exhaust system is adequate for proper operation of the dryer. This test should be performed to alert you to any serious problems in the exhaust system of your home.

- Your dryer features Flow Sense™, an innovative sensing system that automatically detects blockages and restrictions in dryer ductwork. Keeping ductwork clean of lint buildup and free of restrictions allows clothes to dry faster and reduces energy use.

NOTE

The dryer should be cool before starting this test. If the dryer was warmed up during installation, run the AIR DRY cycle for a few minutes to reduce the interior temperature.

To activate the installation test:

1. Remove the literature, and then close the door.

Do not load anything in the drum for this test, as it may affect the accuracy of the results.

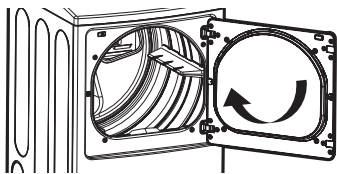

2. Press and hold the Temp. Control and Signal buttons and then press the Power button.

This button sequence activates the installation test. The code **InS** will display if the activation is successful.

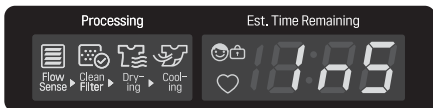

3. Press Start/Pause button.

The dryer will start the test, which will last about two minutes. The heat will be turned on and the temperatures in the drum will be measured.



4. Check the display for results.

During the three minute test cycle, monitor the Flow Sense™ display on the control panel. If no bars are displayed, when the cycle ends, the exhaust system is adequate. If the exhaust system is severely restricted, the display will show four bars. Other problems may also be shown with error codes. Refer to the next page for error code details and solutions.



No Bars: Ok



Four Bars: Restricted

Four bars indicates that the exhaust system is severely restricted. Have the system checked immediately, as performance will be poor.

5. End of cycle.

At the end of the test cycle, **End** will display. The test cycle will end and the dryer will shut off automatically after a short delay.

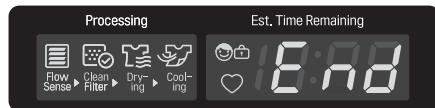

Installation Test (Duct check) (cont.)

- Check the error code before you call for service

Error Code	Possible Causes	Solutions
tE1 or tE2	<ul style="list-style-type: none"> • Temperature sensor failure 	<ul style="list-style-type: none"> • Turn off the dryer and call for service.
HS	<ul style="list-style-type: none"> • Humidity sensor failure. 	<ul style="list-style-type: none"> • Turn off the dryer and call for service.
PS or PF or nP	<ul style="list-style-type: none"> • Electric dryer power cord is not connected correctly, or house power supply is incorrect. • House fuse is blown, circuit breaker has tripped, or power outage has occurred. 	<ul style="list-style-type: none"> • Check the power supply or the connection of power cord to the terminal block. Refer to the Connecting electric dryers section of this manual for complete instructions. • Reset circuit breaker or replace fuse. Do not increase the fuse capacity. If the problem is a circuit overload, have it corrected by a qualified electrician.

• Check the duct condition

If the test displays four bars, check the exhaust system for restrictions and damage. Repair or replace the exhaust system as needed.

! NOTE

When the dryer is first installed, this test should be performed to alert you to any existing problems with the exhaust duct in your home. However, since the test performed during normal operation provides more accurate information on the condition of the exhaust duct than does the installation test, the number of bars displayed during the two tests may not be the same.

Do not interrupt the test cycle, as this could result in the wrong results.

Even if no bars are displayed during the test cycle, some restrictions may still be present in the exhaust system. Refer to the **Venting the Dryer** section of this manual for complete exhaust system and venting requirements.

Your dryer features Flow Sense™, an innovative sensing system that automatically detects blockages and restrictions in dryer ductwork. Keeping ductwork clean of lint buildup and free of restrictions allows clothes to dry faster and reduces energy use.

Restricted or blocked airflow



Avoid long runs or runs with multiple elbows or bends.

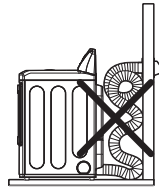

Excess or crushed transition duct

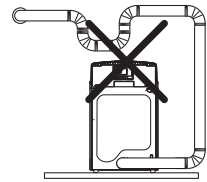

Too many elbows or exhaust too long

Check for blockages and lint buildup.

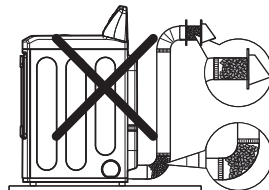

Lint buildup or blockage

Make sure the ductwork is not crushed or restricted.

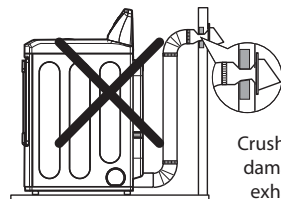

Crushed or damaged exhaust

HOW TO USE

Operating the Dryer

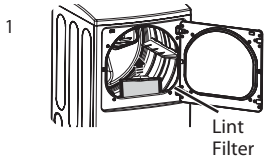

Clean the Lint Filter

If the lint filter has not already been cleaned, lift out the filter and remove the lint from the last load. This will help ensure the fastest and most efficient drying performance.

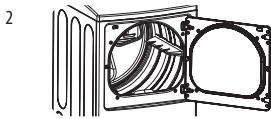

Load the Dryer

Load the dryer with the wet laundry from the washer. If the load is extra large, you may need to divide it into smaller loads for proper performance and fabric care.



Turn On the Dryer

Press the Power button to turn on the dryer. The cycle LEDs will illuminate and a signal will sound, if turned on. Refer to page 10.

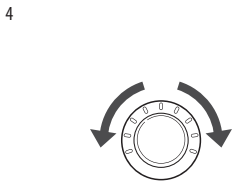

Select a Cycle

Turn the cycle selector knob either direction until the LED for the desired cycle is on. The preset temperature, dry level, and option settings for that cycle will be shown. Refer to page 37. Default settings for the selected cycle can now be changed if desired. This can be done using the cycle modifier buttons as shown on page 37. Cycle options can be added using the option buttons as shown on page 38-41.

NOTE

Not all options or modifiers are available on all cycles. A different chime will sound and the LED will not come on if the selection is not allowed.



Begin the cycle

Press the Start/Pause button to begin the cycle. The cycle can be paused at any time either by opening the door or by pressing the Start/Pause button. If the cycle is not restarted within 4 minutes, the dryer will shut off and the cycle settings will be lost.

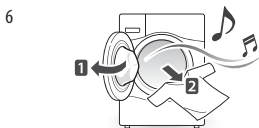

End of Cycle

When the cycle is finished, the chime will sound if it is set. Remove your clothing from the dryer immediately to reduce wrinkling. If Wrinkle Care is selected, the dryer will tumble briefly every few minutes to help prevent wrinkles from setting in the clothes.

Following are instructions for starting and using your new dryer. Please refer to specific sections of this manual for more detailed information.

Sorting Loads

Fabric care labels

Most articles of clothing feature fabric care labels that include instructions for proper care.

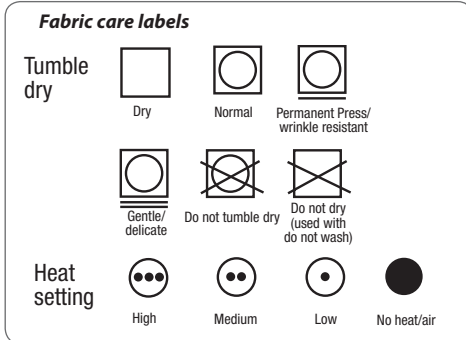

Grouping similar items

For best results, sort clothes into loads that can be dried with the same drying cycle.

Different fabrics have different care requirements, and some fabrics will dry more quickly than others.

Loading the Dryer

⚠ WARNING

To reduce the risk of fire, electric shock, or injury to persons when using this appliance, follow basic precautions, including the following:

- **Check all pockets to make sure that they are empty. Items such as clips, pens, coins, and keys can damage both your dryer and your clothes. Flammable objects such as lighters or matches could ignite, causing a fire.** Failure to do so can result in fire, explosion, or death.
- **Never dry clothes that have been exposed to oil, gasoline, or other flammable substances. Washing clothes will not completely remove oil residues.** Failure to obey this warning can result in fire, explosion, or death.

! NOTE

Loading tips

- Combine large and small items in a load.
- Damp clothes will expand as they dry. Do not overload the dryer; clothes require room to tumble dry properly.
- Close zippers, hooks, and drawstrings to prevent these items from snagging or tangling on other clothes.

Check the Lint Filter Before Every Load

Always make sure the lint filter is clean before starting a new load; a clogged lint filter will increase drying times.

To clean, pull the lint filter straight up and roll any lint off the filter with your fingers. Do not rinse or wash the filter to remove lint. Push the lint filter firmly back into place. See **Regular cleaning** for more information.

Always ensure the lint filter is properly installed before running the dryer. Running the dryer with a loose or missing lint filter will damage the dryer and articles in the dryer.

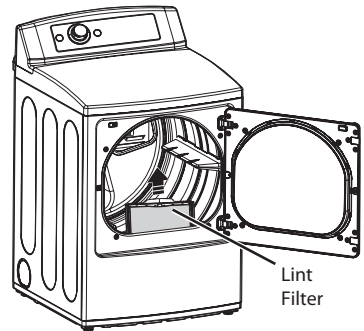

Using the LG EasyLoad™

Swing Door

Use the swing door when unloading, or when loading bulkier items, for easy access to the drum.

To open the swing door, insert your fingers into the handle recess on the top of the door on the side opposite the hinge and pull the door open.

! NOTE

Make sure the hamper door release is completely closed before using the swing door.

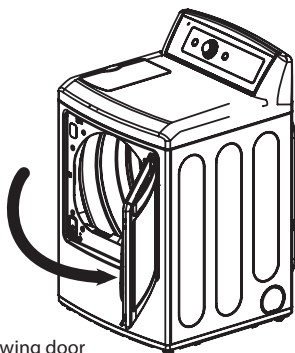

Swing door

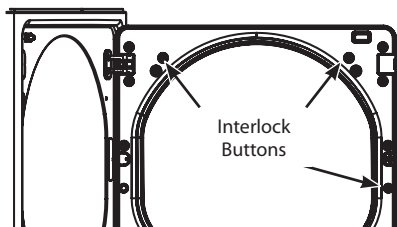

! WARNING

When the door is opened if you press the three interlock buttons, door may fall off.

Failure to follow this warning can cause serious injury.

! WARNING

- Do not place heavy items on or lean against the top of the door when it is open.
- Do not attempt to pull the hamper door open more than 40 degrees.

The dryer could tip forward, causing injury or damage.

Hamper Door

Use the hamper door when loading. It acts as a chute, to help guide items into the drum and help prevent items from falling onto the floor. It also comes in handy when unloading a few small items, helping prevent the rest of the laundry from being pulled onto the floor.

To open the hamper door, press the release in the middle of the handle recess on the top of the door and pull the door forward.

Make sure laundry is fully inserted in the drum before closing the door.

! NOTE

Make sure the swing door latch is completely closed before pressing the hamper door release.

Hamper door latch

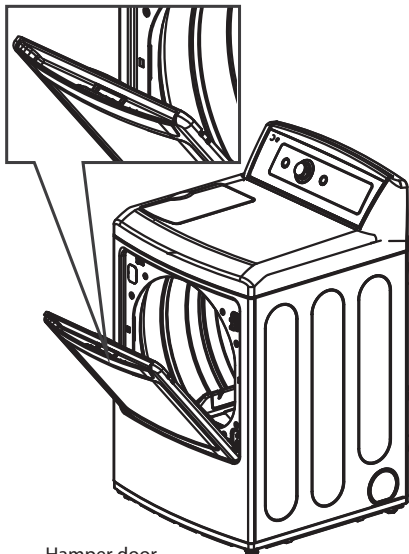

Hamper door

! WARNING

- Be careful when opening and closing the door. Fingers and hands can get caught in the door and cause injury if the door drops forward unexpectedly.

Cycle Guide

Cycle	Fabric Type	Dry Level	Temperature	Time in Min.	More Time/ Less Time	Wrinkle Care	Damp Dry Signal	Reduce Static	Easy Iron	Energy Saver
Steam Fresh™	Comforter, Shirts, Trousers (except especially delicate fabrics)	Off	Medium High	20	Ä	Ä		Ä	Ä	
			Adjustable	Adjustable						
Steam Sanitary™	Comforter, Bedding, Children's clothing	Off	High	39		Ä				
Anti Bacterial	Do not use this cycle with delicate fabrics.	Very Dry	High	70		Ä				
Small Load	Only Normal & Cotton/Towels Fabric Type (Max 3 lb)	Normal Dry	High	30		Ä				
		Adjustable								
Bulky/ Bedding	Comforters, Pillows, Shirts	Normal Dry	Medium	55				Ä		
		Adjustable								
Heavy Duty	Jeans, heavyweight items	Normal Dry	High	54		Ä	Ä	Ä	Ä	
		Adjustable								
Cotton/ Normal	Work clothes, corduroys, etc.	Normal Dry Adjustable	Medium	Elec. : 67 Gas : 76		Ä	Ä	Ä	Ä	Ä
Perm.Press/ Casual	Permanent press, synthetic items	Normal Dry	Low	32		Ä	Ä	Ä	Ä	
		Adjustable								
Towels	Denims, towels, heavy cottons	Normal Dry	Medium High	55		Ä	Ä	Ä	Ä	
		Adjustable								
Sports Wear	Sports Wear	Off	-	27		Ä		Ä		
Delicates	Lingerie, sheets, blouses	Normal Dry	Low	28		Ä	Ä	Ä	Ä	
		Adjustable								
Speed Dry	For small loads with short drying times	Off	High	25	Ä	Ä		Ä	Ä	
			Adjustable	Adjustable						
Air Dry	For items that require heat-free drying such as plastics or rubber	Off	No Heat	30	Ä	Ä				
				Adjustable						

Sensor dry cycles

Sensor dry cycles utilize LG's unique dual sensor system to detect and compare the moisture level in clothes and in the air and adjust the drying time as needed to ensure superior results. The dryer automatically sets the dryness level and temperature at the recommended setting for each cycle. The estimated time remaining will be shown in the display.

NOTE

To protect your garments not every dryness level, temperature, or option is available with every cycle. See the **Cycle Guide** for details.

NOTE

The Energy Saver option is turned on by default in the Normal cycle. For faster drying in the Normal cycle, turn off the Energy Saver option.

Manual dry cycles

Use manual dry cycles to select a specific amount of drying time and a drying temperature. When a manual dry cycle is selected, the Estimated Time Remaining display shows the actual time remaining in your cycle. You can change the actual time in the cycle by pressing More Time or Less Time.

Certified by NSF



NSF International (formerly the National Sanitation Foundation), certifies that Anti Bacterial cycle reduces 99.9% of bacteria on laundry, and none of bacteria will carry over onto the next laundry load.

Cycle Settings and Options

Sensor dry cycles have preset settings that are selected automatically. Manual dry cycles have default settings, but you may also customize the settings using the cycle setting buttons. Press the button for that option to view and select other settings.

NOTE

To protect your garments, not every dryness level, temperature, or option is available with every cycle. See the **Cycle Guide** for details.

Dry Level

Select the level of dryness for the cycle. Press the Dry Level button repeatedly to scroll through available settings.

- This option is only available with sensor dry cycles.
- The dryer will automatically adjust the cycle time. Selecting More Dry or Very Dry will increase the cycle time, while Less Dry or Damp Dry will decrease the cycle time.
- Use a Less Dry or Damp Dry setting for items that you wish to iron.

Temp. Control

Adjusts the temperature setting from Ultra Low to High. This allows precise care of your fabrics and garments. Press the Temp. Control button repeatedly to scroll through available settings.

Time Dry

Allows you to manually select the drying time, from 20 to 60 minutes, in 10-minute increments. Use this for small loads or to remove wrinkles. Use the More Time/Less Time buttons to add or reduce the drying time in 1-minute increments.

Your dryer features several additional cycle options to customize cycles to meet your individual needs. Certain option buttons also feature a special function (see the following page for details) that can be activated by pressing and holding that option button for 3 seconds.

To Add Cycle Options to a Cycle:

1. Turn on the dryer and turn the cycle selector knob to select the desired cycle.
2. Use the cycle settings buttons to adjust the settings for that cycle.
3. Press the cycle option button(s) for the option you would like to add. A confirmation message will be shown in the display.
4. Press the Start/Pause button to start the cycle. The dryer will start automatically.

Wrinkle Care

Selecting this option will tumble the load periodically for up to 3 hours after the selected cycle, or until the door is opened. This is helpful in preventing wrinkles when you are unable to remove items from the dryer immediately.

Signal

To turn the Signal off, press the Signal On/Off button. Press again to turn the Signal back on.

Damp Dry Signal

With this option, the dryer will signal when the load is approximately 80% dry. This allows you to remove faster-drying lightweight items or items that you would like to iron or hang while still slightly damp.

Special functions

The option buttons also activate special functions, including Child Lock and Rack Dry. Select the option by pressing the option button. Press and hold the option button for special features marked with the asterisk (*), such as Child Lock.

* Rack Dry

Use Rack Dry with items, such as wool sweaters, silk, and lingerie, that should dry flat. Rack Dry can also be used with items that should not be tumbled dry, such as gym shoes or stuffed animals.

NOTE

NEVER tumble dry a load of clothing with the rack installed. When the rack is installed, the drum will rotate as usual, but the rack will not move. Make sure all articles to be dried remain completely on the rack and cannot fall off or be pulled off by the turning drum. Be sure to remove the rack after use.

To install the drying rack:

1. With the dryer door open, slide the rack into the dryer drum.

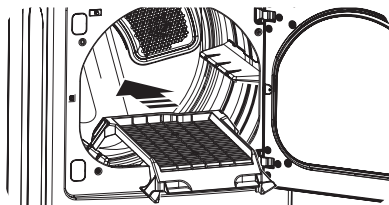

2. Make sure it is seated evenly on the edge of the inner door rim and resting flat on the inside of the dryer.

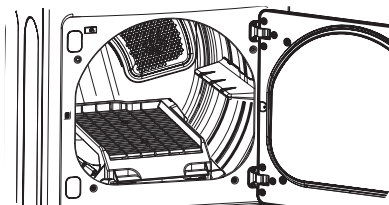

* Child Lock

Use this option to prevent unwanted use of the dryer or to keep cycle settings from being changed while the dryer is operating. Press and hold the Easy Iron button for 3 seconds to activate or deactivate the Child Lock function.

The Child Lock icon will be shown in the display, and all controls are disabled except the Power button.

NOTE

Once set, Child Lock remains active until it is manually deactivated. Child Lock must be turned off to run another cycle. To deactivate Child Lock, press and hold the Easy Iron button for three seconds.

Special Functions. (cont.)

Energy Saver

This option helps to reduce the energy consumption in the Normal cycle, depending on the load size.

The drying time will be changed when the Energy Saver option is selected.

NOTE

The Energy Saver option is turned on by default in the Normal cycle.
For faster drying in the Normal cycle, turn off the Energy Saver option.

Custom Program

If you have a special combination of settings that you use frequently, you can save these settings as a custom program..

* To save a custom program:

1. Turn on the dryer and turn the cycle selector knob to select the desired cycle.
2. Use the cycle setting buttons to adjust the settings for that cycle.
3. Press the cycle option button(s) for the option you would like to add. A confirmation message will be shown in the display.
4. Press and hold the Custom Program button for 3 seconds.

NOTE

You may save only one custom program at a time. Pressing and holding the Custom Program button will overwrite any previously saved custom program.

To recall a custom program:

1. Turn on the dryer.
2. Press the Custom Program button.
3. Press the Start/Pause button to start the cycle.

Steam Functions

To fill the steam feeder

1. Open the lid.

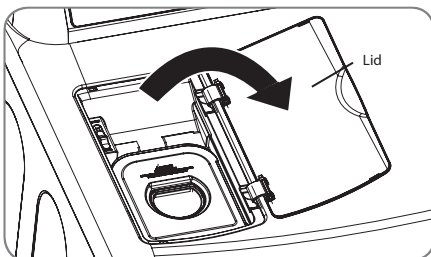

2. Lift out the steam feeder.

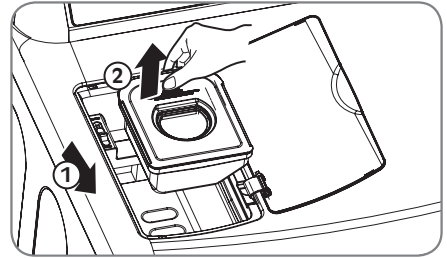

3. Fill the steam feeder to the MAX line with water.

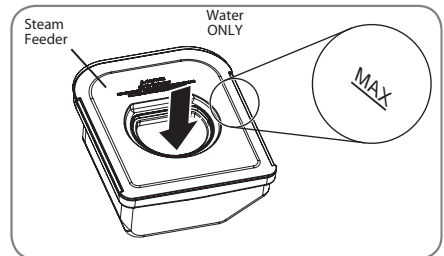

4. Place the steam feeder in the square barrel, then cover the lid.

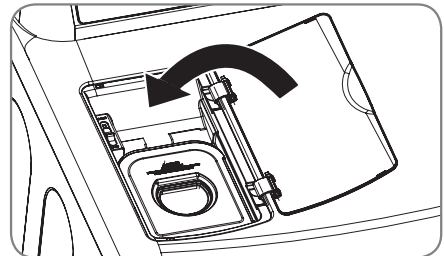

NOTE

Before using a Steam Cycle, the steam feeder must be filled with water up to the MAX line. If not, the will be displayed. Make sure that the steam feeder is filled with water or the drawer is fully closed. Turn the dryer off then restart the steam cycle.

- Only use water. Do not fill the steam feeder with foreign substances, rinse agents, or detergents.
- Before moving the dryer, make sure the steam feeder is empty.
- Do not use distilled water; the water level sensor in the steam generator will not work.
- Be careful to put the Steam Feeder otherwise water will be overflow.
- Wipe up any spilled water around the Steam Feeder and the drawer before starting the dryer.
- Do not fill the steam feeder with hot water (over 86°F/30°C).

WARNING

- **Do not fill the steam feeder with liquids such as gasoline, dry-cleaning solvents, or other flammable or explosive substances.** Failure to follow this warning can cause serious injury or death.
- **Do not drink water from the steam feeder.** Failure to follow this warning can cause serious injury or death.

Steam Functions (cont.)



LG's new steam technology allows you to inject fabrics with a swirling jet of hot steam to refresh clothes, reduce static, and make ironing easier.

Simply select the Steam Fresh™ cycle, or you can add a steam option to selected cycles.

Using the Steam Fresh™ cycle

Steam Fresh™ uses the power of steam alone to quickly reduce wrinkles and odor in fabrics. It brings new life to wrinkled clothes that have been stored for an extended time and makes heavily wrinkled clothes easier to iron. Steam Fresh™ can also be used to help reduce odors in fabrics.

NOTE

- Reduce Static or Easy Iron options can also be used during the Steam Fresh™ cycle.
- Depending on the load (quantity of items), you may change the amount of time for the cycle by pressing the More Time or Less Time button. The display will show 3, 5, or . 3 means 3 or fewer items, 5 is for 4 or 5 items, and  indicates a large load such as a comforter.

To use the Steam Fresh™ cycle:

1. Turn on the dryer and turn the cycle selector knob to select the Steam Fresh™ cycle.
2. To add an option function, select Reduce Static, Easy Iron, or Wrinkle Care.
3. Depending on the load (quantity of items), steam time can be changed by pressing the More Time or Less Time buttons.
4. Press Start/Pause button to start the cycle.

To add steam to a standard cycle:

1. Turn on the dryer and turn the cycle selector knob to select the desired cycle.
2. Use the cycle setting buttons to adjust the settings for that cycle.
3. Press the Steam option button for the Steam option you would like to add. Then adjust for the load size using the More Time or Less Time buttons.
4. Press Start/Pause button to start the cycle.

Using the steam options:

The Reduce Static option injects steam late in the drying cycle to reduce the static electricity caused by dry fabrics rubbing together. Change the amount of time for the cycle by pressing the More Time or Less Time button, depending on the load (quantity of items). The display will show the recommended number of items, such as 7, 9, 11, 14, 16, or 18.

The Easy Iron option provides uniform, properly dampened fabrics for ironing, which can save time and make ironing easier. Change the amount of time for the cycle by pressing the More Time or Less Time button, depending on the load (quantity of items). The display will show the recommended number of items, such as 1, 2, 3, 4, or 5.

NOTE

- When Sensor Dry is selected with the Reduce Static or Easy Iron option, a Dry level of Less or Damp cannot be selected.
- The Reduce Static or Easy Iron option may also be selected during Time Dry cycles.
- After the Steam option is selected in Time Dry, the More Time or Less Time buttons will change the steam time only.
- After pressing Start/Pause, the More Time or Less Time buttons will be disabled.

Using the Steam Sanitary™ cycle

The new Steam Sanitary™ cycle is ideal for sanitizing non washable items quickly and easily using the power of steam alone. Recommend to use this cycle for cotton and polyester material. (Do NOT use for urethane foam, down feathers or delicates items)

Steam Functions (cont.)

⚠ WARNING

- **Do not open the dryer door during steam cycles.** Failure to follow this warning can cause serious injury or death.
- **Do not fill the steam feeder with gasoline, dry-cleaning solvents, or other flammable or explosive substances.** Failure to do so can result in death, explosion, fire, or burns.
- **Do not touch the steam nozzle in the drum during or after the steam cycle.** Failure to follow this warning can cause serious injury or death.

! NOTE

- When Sensor Dry is selected with the Reduce Static option, a Dry level of Less or Damp cannot be selected.
- The Reduce Static or Easy Iron option may also be selected during Time Dry cycles.
- After the Steam option is selected in Time Dry, the More Time or Less Time buttons will change the steam time Only.
- After pressing Start/Pause, the More Time or Less Time buttons will be disabled.

Steam Cycle Guide

	Steam	Default Time	Temp. Control	Dry Level	Fabric State	Fabric Type	Maximum Amount
Steam Sanitary™		39 minutes			Dry	Comforter Bedding	Single (1 each)
			Children's clothing	3 lbs.			
Steam Fresh™		20 minutes	Å		Dry	Comforter	Single (1 each)
						Shirts*	5 each
	+ Reduce Static	10 minutes			Dry	Shirts*	8 lbs. (18 Items.)
	+ Easy Iron	12 minutes			Dry	Shirts*	Shirts* (5 each)
Steam Option	+ Reduce Static	Follows Selected Cycle		Å	Wet	Varies by selected cycle	8 lbs. (18 Items.)
	+ Easy Iron			Å	Wet	Varies by selected cycle	Shirts* (5 each)
Time Dry	+ Reduce Static	45 minutes	Å		Wet	Varies by selected cycle	8 lbs. (18 Items.)
	+ Easy Iron	47 minutes	Å		Wet	Varies by selected cycle	Shirts* (5 each)

*Shirt: 70% cotton:30% poly blend. Except especially delicate fabrics.

- When the lint filter or exhaust duct is clogged, steam options will not give proper results.
- For best results, load articles of similar size and fabric type. Do not overload.

Tag on

- The Tag On function allows you to conveniently use the LG Smart Diagnosis™, Cycle Download, Laundry Stats and Tag On Cycle Set features to communicate with your appliance right from your own smart phone. To use the Tag On functions:

1. Download the LG Smart Laundry&DW App to your smart phone.
2. Turn on the NFC (Near Field Communication) function in your smart phone.

- The Tag On function can only be used with smart phones equipped with the NFC function and based on the Android operating system (OS).

Turning on the Smart Phone's NFC Function

1. Enter the Settings menu of the smart phone and select Share & Connect under WIRELESS & NETWORKS.

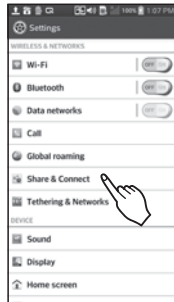

2. **1** Set NFC and Direct/Android Beam to ON, **2** and select NFC.



3. Check the Use Read and Write/P2P Receive option.



NOTE

Depending on the smart phone manufacturer and Android OS version, the NFC activation process may differ. Refer to the manual of your smart phone for details.

Using the Tag On Function

The Tag On icon

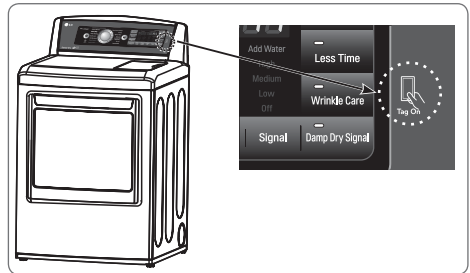

Tag On position



Look for the Tag On icon next to the LED screen on the control panel. This is where you position your smart phone when using the Tag On function of the LG Smart Laundry&DW application.

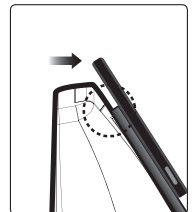

When you use the Tag On function, position your smart phone so that the NFC antenna on the back of your smart phone matches the position of the Tag On icon on the appliance. If you do not know the position of your NFC antenna, move your smart phone very slightly in a circular motion until the application verifies the connection.

Because of the characteristics of NFC, the transmission can fail :

- if the distance is too far
- if the phone has a metal sticker or a thick case
- if the phone doesn't support NFC

Press [?] in the LG Smart Laundry&DW app for a more detailed guide on how to use the Tag On function.

Using Tag On with Applications

Touch the LG appliance's Tag On logo with your NFC-equipped smart phone to use the LG Smart Laundry&DW applications: LG Smart Diagnosis, Cycle Download, Laundry Stats, and Tag on Cycle Set.

Tag On Diagnosis

1. Install LG Smart Laundry & DW application on a NFC-equipped smartphone.

- Install the application from the Play store and run it.



2. Select Tag On.

- Select Tag On by using the top icons or the bottom icons.



3. Select Tag On Diagnosis.



4. Touch the Tag On logo.

- When a Tag On screen appears (see at right), tap your smart phone on the Tag On icon on the right side of the dryer's control panel.
- If it isn't recognized, touch [?] on the upper right of the Tag On screen on your LG Smart Laundry&DW application to see the detailed guide. (This might happen due to the different NFC antenna positions for each phone.)



5. Check the diagnosis results and solutions.

- It shows the diagnosis results on the cycles recently used.

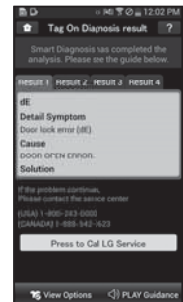

- ※ Images are for reference only. The actual LG Smart Laundry&DW application may be different.

Call Center

If you receive a diagnosis from either the Tag On Diagnosis or Smart Diagnosis application that is unclear or directs you to call the LG Service Center, follow these instructions:

1. Select Press to Call LG Service on the Smart Diagnosis™ Result screen.

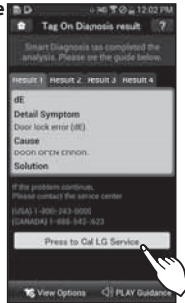

2. Select your country.

3. Agree to Terms and Conditions of the Use and Privacy Policy selecting I Accept.

4. Enter your phone number in the field. Use this phone number when talking to the LG customer service representative to allow them to find your Smart Diagnosis™ data.

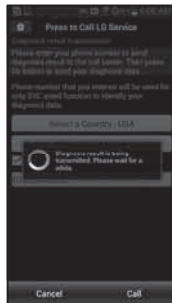
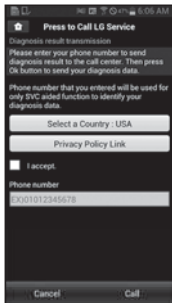

5. Press the Call button to initiate the call to LG's Support Center.



※ Images are for reference only. The actual LG Smart Laundry&DW application may be different.

Tag On Cycles Download

Tag On Cycle Download allows you to download cycles for later use. The cycle is available at the Downloaded cycle position on the control panel until another cycle is downloaded.

1. Install the LG Smart Laundry&DW application on a NFC-equipped smartphone.

- Install the application from the Play store and run it.



2. Select Tag On.

- Select Tag On by using the top icons or the bottom icons.



3. Select Tag On Cycle Download.

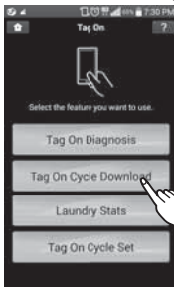

4. Touch the Tag On logo.

- When a Tag On screen appears (see at right), tap your smart phone on the right side of the dryer's control panel.

- If it isn't recognized, touch [?] on the upper right of the Tag On screen on your 'LG Smart Laundry&DW' application to see the detailed guide. (This might happen due to the different NFC antenna positions for each phone.)



5. Select a cycle to download.

- You can also check the existing cycles already downloaded.

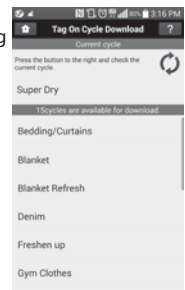

6. Touch the Tag On logo.

- When a Tag On screen appears (see at right), tap your smart phone on the Tag On icon on the right side of the dryer's control panel.

- If it isn't recognized, touch [?] on the upper right of the Tag On screen on your LG Smart Laundry&DW application to see the detailed guide. (This might happen due to the different NFC antenna positions for each phone.)

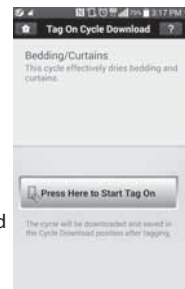

7. The new cycle is downloaded successfully!

- Check the cycle at the Downloaded cycle position on the control panel.



※ Images are for reference only. The actual LG Smart Laundry&DW application may be different.

Laundry Stats

Laundry Stats can monitor the Flow Sense™ result in case your home exhaust system is clogged.

Laundry Stats can also tell you details of your last ten cycles.

1. Select **Tag On** by using the top icons or the bottom icons.



2. Select **Laundry Stats**.



4. Touch the **Tag On** logo.

- When a Tag On screen appears (see at right), tap your smart phone on the Tag On icon on the right side of the dryer's control panel.

- If the phone isn't recognized, touch [?] on the upper right of the Tag On screen on your LG Smart Laundry&DW application to see the detailed guide. (This might happen due to the different NFC antenna positions for each phone.)

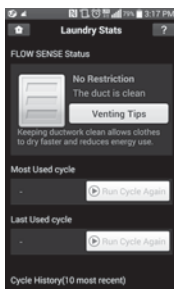
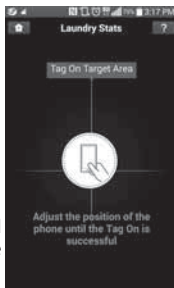

FLOW SENSE™ Status

LG's Flow Sense™ duct blockage sensing system detects and alerts you to restrictions in the installed household ductwork that reduce exhaust airflow through the dryer.

1. Select the **FLOW SENSE™ Status** in the Laundry Stats screen.

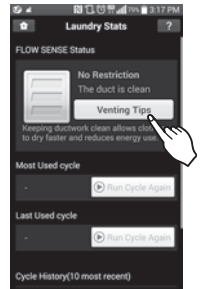

2. If the status shows your home exhaust system is blocked, press the **Venting Tips** button. Refer to pages 22-23 of this manual for more guidance on venting the dryer. Refer to pages 32-33 of this manual for more information regarding Flow Sense™.

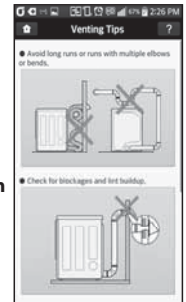

※ Images are for reference only. The actual LG Smart Laundry&DW application may be different.

Run Cycle Again

1. Select the Run Cycle Again button.

- The most used cycle or most recent cycle can be immediately started by selecting the Run Cycle Again button.

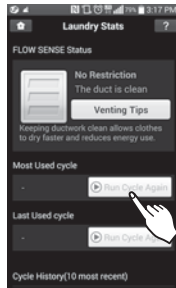

3. Check whether drying starts with the selected cycle.

- The screen shown at right appears and drying starts immediately on the selected cycle.



2. Touch the Tag On logo.

- When a Tag On screen appears (shown at right), tap your smart phone on the Tag On icon on the right side of the dryer's control panel.
- If the phone isn't recognized, touch [?] on the upper right of the Tag On screen on your LG Smart Laundry&DW application to see the detailed guide. (This might happen due to the different NFC antenna positions for each phone.)



- ※ Images are for reference only. The actual LG Smart Laundry&DW application may be different.

Tag On Cycle Set

Tag On Cycle Set allows you to automatically adjust the cycle and settings based on your needs.

1. Select Tag On by using the top icons or the bottom icons.



2. Select Tag On Cycle Set.



3. Touch the Tag On logo.

- When a Tag On screen appears (shown at right), tap your smart phone on the Tag On icon on the right side of the dryer's control panel.

- If the phone isn't recognized, touch [?] on the upper right of the Tag On screen on your LG Smart Laundry&DW application to see the detailed guide. (This might happen due to the different NFC antenna positions for each phone.)



4. Select a laundry category based on the issue you want the machine to focus on.

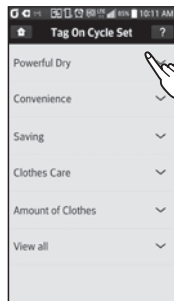

5. After selecting the category, a list of specific cycles will appear. Select the cycle based on your needs.

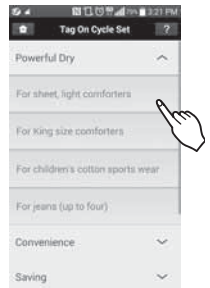

6. When the Tag On screen appears (shown at right), tap your smart phone on the Tag On logo on the right side of the washer's or dryer's control panel.

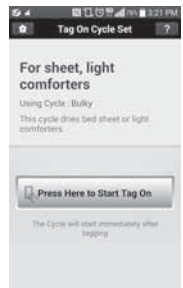

7. After tagging the machine with your phone, the cycle will automatically start. Verify the correct cycle and settings were selected.

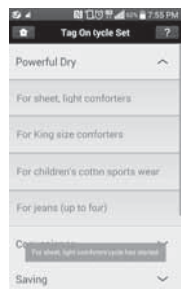

※ Images are for reference only. The actual LG Smart Laundry&DW application may be different.

MAINTENANCE

Regular Cleaning

⚠ WARNING

To reduce the risk of fire, electric shock, or injury to persons when using this appliance, follow basic precautions, including the following:

- **Unplug the dryer before cleaning to avoid the risk of electric shock.** Failure to follow this warning can cause serious injury, fire, electrical shock, or death.
- **Never use harsh chemicals, abrasive cleaners, or solvents to clean the washer.** They will damage the finish.
- To prevent injury during care and maintenance/cleaning, wear gloves or protective clothing.

Cleaning the Exterior

Proper care of your dryer can extend its life. The outside of the machine can be cleaned with warm water and a mild, nonabrasive household detergent. Immediately wipe off any spills with a soft, damp cloth.

! NOTE

Do not use methylated spirits, solvents, or similar products.

Never use steel wool or abrasive cleansers; they can damage the surface.

Cleaning the Interior

Wipe around the door opening and seal with a soft, damp cloth to prevent lint and dust buildup that could damage the door seal.

Clean the window with a soft cloth dampened with warm water and a mild, nonabrasive household detergent; then wipe dry.

The stainless steel drum can be cleaned with a conventional stainless steel cleaner, used according to the manufacturer's specifications.

Never use steel wool or abrasive cleansers; they can scratch or damage the surface.

Cleaning Around and Under the Dryer

Vacuum lint and dust from around the dryer and underneath it regularly. Vent ductwork should be checked for lint buildup and cleaned at least once per year. If any noticeable reduction in airflow or drying performance occurs, immediately check ductwork for obstructions and blockages.

Maintaining Ductwork

Vent ductwork should be checked for lint buildup once per month and cleaned at least once per year. If any noticeable reduction in airflow or drying performance occurs, immediately check ductwork for obstructions and blockages. Contact a qualified technician or service provider.

Cleaning the Lint Filter

Always clean the lint from the filter after every cycle.

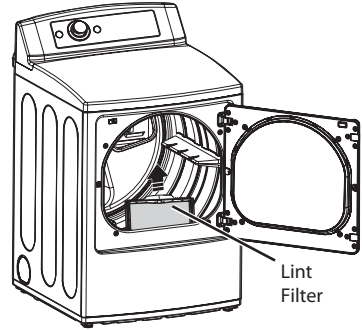

To clean, open the dryer door and pull the lint filter straight up. Then:

1. For everyday cleaning, roll any lint off the filter with your fingers, or

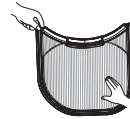

2. Vacuum the lint filter

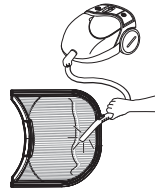

3. If the lint filter has become very dirty or clogged with fabric softener, wash the lint filter in warm, soapy water and allow to dry thoroughly before reinstalling.

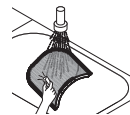

! NOTE

NEVER operate the dryer without the lint filter in place. NEVER operate the dryer with a wet lint filter.

TROUBLESHOOTING

Before Calling For Service

Your dryer is equipped with an automatic error-monitoring system to detect and diagnose problems at an early stage. If your dryer does not function properly or does not function at all, check the following before you call for service.

Problem	Possible Causes	Solutions
Dryer will not turn on	<ul style="list-style-type: none"> • Power cord is not properly plugged in. • House fuse is blown, circuit breaker has tripped, or power outage has occurred. 	<ul style="list-style-type: none"> • Make sure that the plug is plugged securely into a grounded outlet matching the dryer's rating plate. • Reset circuit breaker or replace fuse. Do not increase fuse capacity. If the problem is a circuit overload, have it corrected by a qualified electrician.
Dryer does not heat	<ul style="list-style-type: none"> • House fuse is blown, circuit breaker has tripped, or power outage has occurred. • Gas supply or service turned off (gas models only). 	<ul style="list-style-type: none"> • Reset circuit breaker or replace fuse. Do not increase fuse capacity. If the problem is a circuit overload, have it corrected by a qualified electrician. • Confirm that the house gas shutoff and the dryer gas shutoff are both fully open.
Greasy or dirty spots on clothes	<ul style="list-style-type: none"> • Fabric softener used incorrectly. • Clean and dirty clothes being dried together. 	<ul style="list-style-type: none"> • Confirm and follow the instructions provided with your fabric softener. • Make sure to use your dryer to dry only clean items, because dirty items can soil clean clothes placed in the same or subsequent loads. • Stains on dried clothes are actually stains that were not removed during the washing process. Make sure that clothes are being completely cleaned according to the instructions for your washer and detergent.
Display shows error code tE1 or tE2	<ul style="list-style-type: none"> • Thermistor is malfunctioning. 	<ul style="list-style-type: none"> • Turn off the dryer and call for service.
Lint on clothes	<ul style="list-style-type: none"> • Lint filter not cleaned properly. • Laundry not sorted properly. • Excess static in clothes. • Dryer is overloaded. • Tissue, paper, etc., left in pockets. 	<ul style="list-style-type: none"> • Make sure the lint filter is cleaned before every load. With some loads that produce high amounts of lint, it may be necessary to clean the filter during the cycle. • Some fabrics are lint producers (i.e., a fuzzy white cotton towel) and should be dried separately from clothes that are lint trappers (i.e., a pair of black linen pants). • See the Excess static in clothes after drying section below. • Divide larger loads into smaller loads for drying. • Check pockets thoroughly before washing and drying clothes.
Excess static in clothes after drying	<ul style="list-style-type: none"> • Fabric softener not used or used incorrectly. • Clothes dried too long (overdried). • Drying synthetics, permanent press, or synthetic blends. 	<ul style="list-style-type: none"> • Use a fabric softener to reduce static electricity correctly. Do not use fabric softeners or products to eliminate static unless recommended by the manufacturer of the fabric softener or product. • Overdrying a load of laundry can cause a buildup of static electricity. Adjust settings and use a shorter drying time, or use Sensor Dry cycles. • These materials can cause static buildup. Try using a fabric softener.
Display shows error code PS	<ul style="list-style-type: none"> • Power cord connection is incorrect. 	<ul style="list-style-type: none"> • Check the connection of power cord to the terminal block. Refer to pages in26-30 this manual.
Drying time is not consistent	<ul style="list-style-type: none"> • Heat settings, load size, or dampness of clothing is not consistent. 	<ul style="list-style-type: none"> • The drying time for a load will vary depending on the heat setting, the type of heat used (electric, natural gas, or LP gas), the size of the load, the type of fabrics, the wetness of the clothes, and the condition of the exhaust ducts and lint filter.

Before Calling For Service (cont.)

Problem	Possible Causes	Solutions
Clothes take too long to dry	<ul style="list-style-type: none"> • Load is not properly sorted. • Large load of heavy fabrics. • Dryer controls are not set properly. • Lint filter needs to be cleaned. • Exhaust ducts blocked, dirty, or duct run is too long. • House fuse is blown, circuit breaker has tripped, or power outage has occurred. • Dryer is overloaded. • Dryer is underloaded. 	<ul style="list-style-type: none"> • Separate heavy items from lightweight items. Larger and heavier items take longer to dry. • Heavy fabrics take longer to dry because they tend to retain more moisture. To help reduce and maintain more consistent drying times for large and heavy fabrics, separate these items into smaller loads of a consistent size. • Use the appropriate control settings for the type of load you are drying. • Make sure the lint filter is cleaned before every load. With some loads that produce high amounts of lint, it may be necessary to clean the filter during the cycle. • Confirm that the exhaust ductwork is properly configured and free of debris, lint, and obstructions. Make sure that outside wall dampers can open properly and are not blocked, jammed, or damaged. • Reset circuit breaker or replace fuse. Do not increase fuse capacity. If the problem is a circuit overload, have it corrected by a qualified electrician. • Divide larger loads into smaller loads for drying. • If you are drying a very small load, add a few extra items to ensure proper tumbling action.
Clothes are wrinkled	<ul style="list-style-type: none"> • Clothes dried too long (overdried). • Clothes left in dryer too long after cycle ends. 	<ul style="list-style-type: none"> • Overdrying a load of laundry can lead to wrinkled clothes. Try a shorter drying time, and remove items while they still retain a slight amount of moisture. • Remove items from the dryer immediately at the end of the cycle. Use the Wrinkle Care option to continue tumbling clothes at the end of the cycle, for up to 3 hours.
Clothes are shrinking	<ul style="list-style-type: none"> • Garment care instructions are not being followed. 	<ul style="list-style-type: none"> • To avoid shrinkage, please carefully follow the fabric care instructions for your garment, because some fabrics will naturally shrink when washed. Other fabrics can be washed but will shrink when dried in a dryer. Use a low or no heat setting.
<div style="background-color: #cccccc; padding: 2px; display: inline-block; font-weight: bold;">Add Water</div> indicator light is on during the drying cycle	<ul style="list-style-type: none"> • Water supply error. 	<ul style="list-style-type: none"> • Check steam feeder drawer: <ol style="list-style-type: none"> (1) Make sure steam feeder is filled with water to MAX line. (2) Make sure steam feeder is seated properly and drawer is fully closed. (3) Turn the dryer off then restart the Steam cycle. • Do not use distilled water; the water level sensor in steam generator will not work. • Pump not working. Unplug dryer and call for service.
Water drips from nozzle when Steam Cycle starts	<ul style="list-style-type: none"> • This is normal. 	<ul style="list-style-type: none"> • This is steam condensation. The dripping water will stop after a short time.
Steam does not generate but no error code is shown	<ul style="list-style-type: none"> • Water level error. 	<ul style="list-style-type: none"> • Unplug dryer and call for service.
Garments still wrinkled after Steam Fresh™	<ul style="list-style-type: none"> • Too many or too different types of garments in dryer. 	<ul style="list-style-type: none"> • Small loads of 1 to 5 items work best. • Load fewer garments. Load similar-type garments.

Before Calling For Service (cont.)

Problem	Possible Causes	Solutions
There are no creases left on garment after Steam Fresh™	<ul style="list-style-type: none"> The function of this cycle is to remove wrinkles from fabric. 	<ul style="list-style-type: none"> Use an iron to make creases.
Garments have static after Reduce Static	<ul style="list-style-type: none"> This is normal. 	<ul style="list-style-type: none"> Depends on individual moisture level in skin.
Garments are too damp or too dry after Reduce Static	<ul style="list-style-type: none"> Correct drying options not selected. 	<ul style="list-style-type: none"> Select load weight manually before starting Reduce Static option.
Garments are not uniformly damp after Easy Iron	<ul style="list-style-type: none"> Number of garments or load size not properly selected at the beginning of the cycle. 	<ul style="list-style-type: none"> Select the correct number or garments or load size before starting the cycle.
Water drips from door during Steam Cycle	<ul style="list-style-type: none"> This is normal. 	<ul style="list-style-type: none"> Condensation will normally form on the inside of the dryer door during steam operation. Some condensation may drip out the bottom of the door.
Steam is not visible during Steam Cycle	<ul style="list-style-type: none"> This is normal. 	<ul style="list-style-type: none"> Steam vapor is difficult to see when the door is closed. However, condensation will normally form on the inside of the dryer door if the steam system is operating normally.
Drum does not turn during Steam Cycle	<ul style="list-style-type: none"> This is normal. 	<ul style="list-style-type: none"> The drum is turned off so that the steam vapor remains in the drum. The drum will normally turn for about 2 seconds once a minute.
Cannot see steam vapor at the beginning of cycle	<ul style="list-style-type: none"> This is normal. 	<ul style="list-style-type: none"> Steam is released at different stages of the cycle for each option.
The display shows 	<ul style="list-style-type: none"> More Time button pressed. 	<ul style="list-style-type: none"> This display indicates that the steam option has been set for a "bl 9" item such as a comforter. Press the Less Time button to reduce the indicated load size.
Odors remain in clothing after Steam Fresh™	<ul style="list-style-type: none"> Steam Fresh™ did not remove odor completely. 	<ul style="list-style-type: none"> Fabrics containing strong odors should be washed in a normal cycle.
Clean Filter light is on during the drying cycle	<ul style="list-style-type: none"> Lint filter is almost clogged or full. 	<ul style="list-style-type: none"> Pause the drying cycle and clean the lint filter.
Flow Sense™ indicator shows four bars during the drying cycle	<ul style="list-style-type: none"> Ductwork is too long or has too many turns/restrictions. Significant blockage of the ductwork due to lint buildup or debris. The appliance has detected a restriction in the external dryer venting. 	<ul style="list-style-type: none"> Install a shorter or straighter duct run. See the Installation Instructions. Ductwork should be checked/cleaned soon. Dryer can be used in this condition, but drying times may be longer. If exhaust restrictions are sensed by the Flow Sense™ system, the indicator will remain on for two hours after the end of the cycle. Opening the door or pressing the Power button will turn off the display.

SPECIFICATIONS

Steam Dryer™ Models	DLEX5780*E DLGX5781*E
Description	Steam Dryer
Electrical requirements	Please refer to the rating label regarding detailed information.
Gas requirements	NG 4-10.5 inches WC LP: 8-13 inches WC (Gas Models only)
Max. water pressure	21.8 ~ 116 psi (150 ~ 800 kPa)
Dimensions	27" (W) X 28 15/16" (D) X 45 7/16" (H), 50 1/4" (D with door open) 68.6 cm (W) X 73.4 cm (D) X 115.3 cm (H), 127.5 cm (D with door open)
Net weight	Gas dryer : 139.1lbs(63.1kg) Electric dryer : 136.3lbs(61.8kg)
Drying capacity - Normal cycle - Steam cycle	IEC 7.3 cu.ft. (22.5 lbs/10.2 kg) IEC 7.3 cu.ft. (8 lbs/3.6 kg)

USING Smart Diagnosis™

Should you experience any problems with your dryer, it has the capability of transmitting data to your Smart Phone using the LG Smart Laundry Application or via your telephone to the LG call center.

Smart Diagnosis™ cannot be activated unless your dryer is turned on by pressing the Power button. If your dryer is unable to turn on, then troubleshooting must be done without using Smart Diagnosis™.

Audible Diagnosis

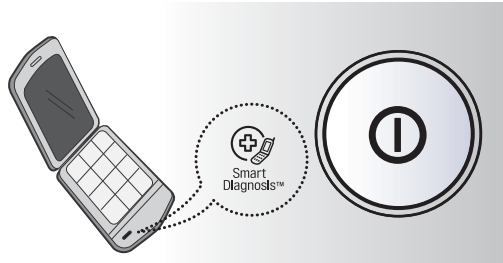

Smart Diagnosis™ Using Your Smart Phone

1. Download the LG Smart Laundry application on your smart phone.
2. Open the LG Smart Laundry application on your smart phone. Press the right arrow button to advance to the next screen.
3. Press the Record button on the smart phone and then hold the mouth piece of the smart phone near the Smart Diagnosis™ logo on the dryer.
4. With the phone held in place, press and hold Temp. Control button for three seconds.
5. Keep the phone in place until the tone transmission has finished. It takes time on panel displayed.
6. When the recording is complete, view the diagnosis by pressing the Next button on the phone.

! NOTE

Smart Diagnosis™ is a troubleshooting feature designed to assist, not replace, the traditional method of troubleshooting through service calls. The effectiveness of this feature depends upon various factors, including, but not limited to, the reception of the cellular phone being used for transmission, any external noise that may be present during the transmission, and the acoustics of the room where the machine is located.

Accordingly, LG does not guarantee that Smart Diagnosis™ would accurately troubleshoot any given issue.

Smart Diagnosis™ Through the Call Center

1. Call the LG call center at: (LG U.S.) 1-800-243-0000 (LG Canada) 1-888-542-2623.
2. When instructed to do so by the call center agent, hold the mouthpiece of your phone over the Smart Diagnosis™ logo on the machine. Hold the phone no more than one inch (but not touching) the machine.

! NOTE

Do not touch any other buttons or icons on the display screen.

3. Press and hold the Temp. Control button for three seconds.
4. Keep the phone in place until the tone transmission has finished. It takes time on panel displayed.
5. Once the countdown is over and the tones have stopped, resume your conversation with the call center agent, who will then be able to assist you in using the information transmitted for analysis.

LG ELECTRONICS, INC. LG DRYER LIMITED WARRANTY - USA

Your LG Dryer will be repaired or replaced, at LG's option, if it proves to be defective in material or workmanship under normal use, during the warranty period ("Warranty Period") set forth below, effective from the date ("Date of Purchase") of original consumer purchase of the product. This warranty is good only to the original purchaser of the product and effective only when used in the United States, including Alaska, Hawaii, and U.S. Territories.

WARRANTY PERIOD:

LABOR: One Year from the Date of Purchase.

PARTS: One Year from the Date of Purchase.

Replacement Units and Repair Parts may be new or remanufactured.

Replacement Units and Repair Parts are warranted for the remaining portion of the original unit's warranty period.

Dryer drum 10 years limited warranty.

10 years warranty on Dryer Drum, including parts & labor.

HOW SERVICE IS HANDLED:

In-Home Service:

Please retain dealer's dated bill of sale or delivery ticket as evidence of the Date of Purchase for proof of warranty, and submit a copy of the bill of sale to the service person at the time warranty service is provided.

Please call 1-800-243-0000 and choose the appropriate option to locate your nearest LG Authorized Service Center.

Or visit our Web site at: <http://www.lgservice.com>.

THIS WARRANTY IS IN LIEU OF ANY OTHER WARRANTY, EXPRESS OR IMPLIED, INCLUDING WITHOUT LIMITATION, ANY WARRANTY OF MERCHANTABILITY OR FITNESS FOR A PARTICULAR PURPOSE. TO THE EXTENT ANY IMPLIED WARRANTY IS REQUIRED BY LAW, IT IS LIMITED IN DURATION TO THE EXPRESS WARRANTY PERIOD ABOVE.

NEITHER THE MANUFACTURER NOR ITS U.S. DISTRIBUTOR SHALL BE LIABLE FOR ANY INCIDENTAL, CONSEQUENTIAL, INDIRECT, SPECIAL, OR PUNITIVE DAMAGES OF ANY NATURE, INCLUDING WITHOUT LIMITATION, LOST REVENUES OR PROFITS, OR ANY OTHER DAMAGE WHETHER BASED IN CONTRACT, TORT, OR OTHERWISE. Some states do not allow the exclusion or limitation of incidental or consequential damages or limitations on how long an implied warranty lasts, so the above exclusion or limitation may not apply to you. This warranty gives you specific legal rights and you may also have other rights that vary from state to state.

THIS LIMITED WARRANTY DOES NOT APPLY TO:

- Service trips to your home to deliver, pick up, and/or install the product, instruct, or replace house fuses or correct wiring, or correction of unauthorized repairs.
- Damages or operating problems that result from misuse, abuse, operation outside environmental specifications or contrary to the requirements of precautions in the Operating Guide, accident, vermin, fire, flood, improper installation, acts of God, unauthorized modification or alteration, incorrect electrical current or voltage, or commercial use, or use for other than intended purpose.

The cost of repair or replacement under these excluded circumstances shall be borne by the consumer.

CUSTOMER INFORMATION CENTER NUMBERS

To obtain Customer Assistance, Product Information, or Dealer or Authorized Service Center location:

Call 1-800-243-0000 (24 hours a day, 365 days per year), and select the appropriate option from the menu.

Or visit our Web site at: <http://www.lgservice.com>.

TO CONTACT LG ELECTRONICS BY MAIL:

LG Customer Information Center
P. O. Box 240007
201 James Record Road
Huntsville, Alabama 35824
ATTN: CIC

Product Registration Information

Model:

Serial Number:

Date of Purchase:

The model and serial number can be located on the rating plate inside the front door.

Free Manuals Download Website

<http://myh66.com>

<http://usermanuals.us>

<http://www.somanuals.com>

<http://www.4manuals.cc>

<http://www.manual-lib.com>

<http://www.404manual.com>

<http://www.luxmanual.com>

<http://aubethermostatmanual.com>

Golf course search by state

<http://golfingnear.com>

Email search by domain

<http://emailbydomain.com>

Auto manuals search

<http://auto.somanuals.com>

TV manuals search

<http://tv.somanuals.com>