



# Owner's Manual

## Electric and Gas Dryer

TD-V12240E / TD-V12240G  
TD-V12246E / TD-V12246G

Thank you for buying an LG Dryer.  
Please read your manual carefully, as it provides instructions  
on safe Installation, use and maintenance.  
Record the model and serial numbers,  
and retain the manual for future reference.



## PRODUCT FEATURES

1

### **OUTSTANDING PERFORMANCE**

Not to mention unmatched big capacity, you can benefit from good time efficiency, quiet operation and energy saving system.

2

### **DOUBLE-COATED STEEL DRUM**

It is coated with one metal coating and the other polymer coating in order to guarantee high durability and the long life.

3

### **ARTISTIC DESIGN**

Modern front panel look and big crystal-clear glass door make your house look stylish.

4

### **DIGITAL FABRIC CARE**

Multi-level temperature control heater takes a better care on your valued clothes.

5

### **EASY OF USE**

A whole selection of user-friendly functions always make you comfortable with dryer operation.

### What are Sensor Dry and Time Dry?

Your dryer provides sensor drying and time drying programs.

#### **Sensor Dry**

The dryer senses the dampness of the laundry and automatically determines the heat level and operation time. You might see a sudden increase or decrease in operation time if the sensor determines more or less drying is required. This is not a malfunction.

#### **Time Dry**

Use TIME DRY to select heat level and drying time manually. This can be used if clothes are not as dry as you like them at the end of the cycle. Use TIME DRY for heavy and bulky items and thick work.

## TABLE OF CONTENTS

PART 1. SPECIFICATIONS .....	3
PART 2. IMPORTANT WARRANTY AND SAFETY INSTRUCTIONS .....	4
PART 3. INITIAL STEPS FOR INSTALLING YOUR DRYER .....	9
PART 4. ACCESSORIES INSTALLATION .....	15
PART 5. ELECTRICAL REQUIREMENTS FOR ELECTRIC DRYERS .....	17
PART 6. ELECTRICAL REQUIREMENTS FOR GAS DRYERS.....	21
PART 7. GAS REQUIREMENTS AND INSTRUCTIONS .....	22
PART 8. EXHAUST REQUIREMENTS AND MAINTENANCE .....	23
PART 9. OPERATING YOUR DRYER .....	25
PART 10. TROUBLESHOOTING GUIDE.....	31



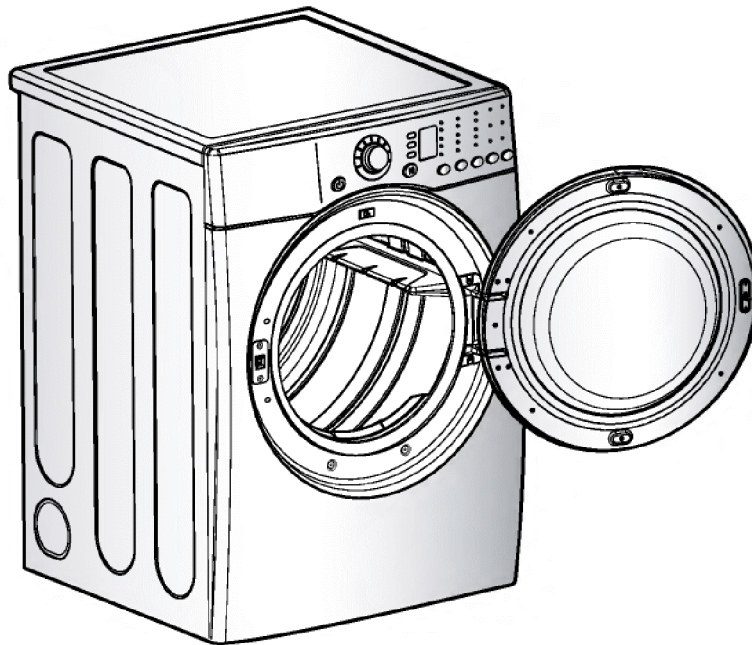

- Type : Electric and Gas Dryer
- Rating : Please refer to the rating label regarding detailed information.
- Size : 686 x 730 x 965 (mm)
- Capacity : 12 kg
- Weight : 126 lbs (57,2 kg)

\* Specifications are subject to change by manufacturer.

■ ACCESSORIES

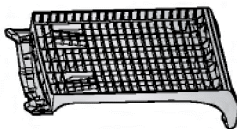

Dryer Rack  
Purchased Separately  
*See page 28 for instructions.*



Stacking Kit  
Purchased Separately  
*See page 15 for instructions.*



## SEEKING WARRANTY SERVICE

The warranty for your dryer is located at the end of this manual. Warranty Service is available by contacting your nearest LG Service Center. If this product is installed and operated according to the instructions in this manual, LG will repair or replace any parts defective in material or workmanship throughout the warranty period, beginning with the date of purchase.

**⚠ WARNING!**

For your safety, the recommendations in this manual must be followed. To reduce the risk of fire or explosion, electric shock or to prevent property damage, personal injury, or death when using your appliance follow basic precautions.

**Warranty Restriction:** If the dryer is subjected to other than single family use, all warranty coverage is effective for only 90 days.

You will need the complete model and serial number when requesting warranty service. proof of purchase date is required.

Use the space below to record the model number and serial number of your new LG dryer.

Model Number. \_\_\_\_\_

Serial Number. \_\_\_\_\_

Date of Purchase \_\_\_\_\_

\* Staple your receipt here for convenience when contacting service.



## READ ALL INSTRUCTIONS BEFORE USE

**⚠ WARNING** For your safety, the information in this manual must be followed to minimize the risk of fire or explosion, electric shock, or to prevent property damage, personal injury, or loss of life.

### Your Safety and the safety of others are very important.

We have provided many important safety messages in this manual and on your appliance. Always read and obey all safety messages.



This is the safety alert symbol.

This symbol alerts you to potential hazards that can kill or hurt you and others.

All safety messages will follow the safety alert symbol and either the word DANGER or WARNING.

These words mean:

**⚠ DANGER** You can be killed or seriously injured if you don't immediately follow instructions.

**⚠ WARNING** You can be killed or seriously injured if you don't follow instructions.

All safety messages will tell you what the potential hazard is, tell you how to reduce the chance of injury, and tell you what can happen if the instructions are not followed.

## BASIC SAFETY PRECAUTIONS

**⚠ WARNING** To reduce the risk of fire, electric shock or injury to persons when using your appliance, follow basic precautions, including the following :

- Read all instructions before using the dryer.
- Before use, the dryer must be properly installed as described in this manual.
- Do not place items exposed to cooking oils in your dryer. Items contaminated with cooking oils may contribute to a chemical reaction that could cause a load to catch fire.  
Do not dry articles that have been previously cleaned in, washed in, soaked in, or spotted with gasoline, dry-cleaning solvents, other flammable or explosive substances as they give off vapors that could ignite or explode.
- Do not reach into the dryer if the drum is moving.
- Do not repair or replace any part of the dryer or attempt any servicing unless specifically recommended in this Use and Care Guide or in published user-repair instructions that you understand and have the skills to carry out.
- Do not tamper with controls.
- Before the dryer is removed from service or discarded, remove the door to the drying compartment.
- Do not allow children to play on or in the dryer.  
Close supervision of children is necessary when the dryer is used near children.
- Do not use fabric softeners or products to eliminate static unless recommended by the manufacturer of the fabric softener or product.
- Do not use heat to dry articles containing foam rubber or similarly textured rubber-like materials.
- Keep area around the exhaust opening and adjacent surrounding areas free from the accumulation of lint, dust, and dirt.
- The interior of the dryer and exhaust vent should be cleaned periodically by qualified service personnel.
- Do not install or store the dryer where it will be exposed to the weather.
- Do not reach into the dryer while parts are moving.
- Always check the inside of the dryer for foreign objects
- Clean lint screen before or after each load.

## SAVE THESE INSTRUCTIONS

### GROUNDING INSTRUCTIONS

This appliance must be grounded. In the event of malfunction or breakdown, grounding will reduce the risk of electric shock by providing a path of least resistance for electric current.

This appliance must be equipped with a cord having an equipment-grounding conductor and a grounding plug. The plug must be plugged into an appropriate outlet that is properly installed and grounded in accordance with all local codes and ordinances.

**WARNING** - Improper connection of the equipment-grounding conductor can result in a risk of electric shock. Check with a qualified electrician or service person if you are in doubt as to whether the appliance is properly grounded. Do not modify the plug provided with the appliance.

If it will not fit the outlet, have a proper outlet installed by a qualified electrician.

This appliance must be connected to a grounded metal, permanent wiring system or an equipment-grounding conductor must be run with the circuit conductors and connected to the equipment-grounding terminal or lead on the appliance.



## READ ALL INSTRUCTIONS BEFORE USE

**⚠ WARNING** For your safety, the information in this manual must be followed to minimize the risk of fire or explosion, electric shock, or to prevent property damage, personal injury, or loss of life.

- Do not store or use gasoline or other flammable vapors and liquids in the vicinity of this appliance or any other appliance.
- Installation and service must be performed by a qualified installer, service agency, or the gas supplier.

### WHAT TO DO IF YOU SMELL GAS

**⚠ WARNING** To reduce the risk of fire, electric shock, or injury to persons when using the appliance, follow basic precautions, including the following:

1. Do not try to light a match or cigarette, or turn on any gas or electrical appliance.
2. Do not touch any electrical switches. Do not use any phone in your building.
3. Clear the room, building, or area of all occupants.
4. Immediately call your gas supplier from a neighbor's phone. Follow the gas supplier's phone. Follow the gas supplier's instructions carefully.
5. If you cannot reach your gas supplier, call the fire department.

### CALIFORNIA SAFE DRINKING WATER AND TOXIC ENFORCEMENT ACT

**⚠ WARNING** To reduce the risk of fire, electric shock, or injury to persons when using the appliance, follow basic precautions, including the following:

This act requires the governor of California to publish a list of substances known to the state to cause cancer, birth defects, or other reproductive harm and requires businesses to warn customers of potential exposure to such substances.

Gas appliances can cause minor exposure to four of these substances, namely benzene, carbon monoxide, formaldehyde, and soot, caused primarily by the incomplete combustion of natural gas or LP fuels.

Properly adjusted dryers will minimize incomplete combustion. Exposure to these substances can be minimized further by properly venting the dryer to the outdoors.



## READ ALL INSTRUCTIONS BEFORE USE

**⚠ WARNING** For your safety, the information in this manual must be followed to minimize the risk of fire or explosion, electric shock, or to prevent property damage, personal injury, or loss of life.

### SAFETY INSTRUCTION FOR INSTALLATION

**⚠ WARNING** To reduce the risk of fire, electric shock, or injury to persons when using the appliance, follow basic precautions, including the following:

- Properly ground dryer to conform with all governing codes and ordinances. Follow details in the installation instructions.

Electrical shock can result if the dryer is not properly grounded.

- Before use, the dryer must be properly installed as described in this manual.

Electrical shock can result if the dryer is not properly grounded.

- Install and store the dryer where it will not be exposed to temperatures below freezing or exposed to the weather.

All repairs and servicing must be performed by an authorized servicer unless specifically recommended in this Owner's Guide. Use only authorized factory parts. Failure to follow this warning can cause serious injury, fire, electrical shock or death.

- Do not install the washer in humid spaces to reduce the risk of electric shock.

Failure to follow this warning can cause serious injury, fire, electrical shock or death.

- Connect to a properly rated, protected, and sized power circuit to avoid electrical overload.

Improper power circuit can melt, creating electrical shock and/or fire hazard.

- Remove all packing items and dispose of all shipping materials properly.

Failure to do so can result in death, explosion, fire or burns.

- Place dryer at least 18 in. above the floor for a garage installation.

Failure to do so can result in death, explosion, fire or burns.

#### Exhaust/Ducting:

- Gas dryers **MUST** be exhausted to the outside.

Failure to follow these instructions can result in fire or death.

- The dryer exhaust system must be exhausted to the outside of the dwelling.

The dryer is not exhausted outdoors, some fine lint and large amounts of moisture will be expelled into the laundry area. An accumulation of lint in any area of the home can create a health and fire hazard.

- Use only rigid metal or flexible metal 4in. Diameter ductwork inside the dryer cabinet or for exhausting to the outside.

Use of plastic or other combustible ductwork can cause a fire. Punctured ductwork can cause a fire if it collapses or becomes otherwise restricted in use or during installation.

- Ductwork is not provided with the dryer, and you should obtain the necessary ductwork locally. The end cap should have hinged dampers to prevent back draft when the dryer is not in use.

Failure to follow these instructions can result in fire or death.

- The exhaust duct must be 4 in. (10 cm) in diameter with no obstructions. The exhaust duct should be kept as short as possible. Make sure to clean any old ducts before installing your new dryer.

Failure to follow these instructions can result in fire or death.



## READ ALL INSTRUCTIONS BEFORE USE

**⚠ WARNING** For your safety, the information in this manual must be followed to minimize the risk of fire or explosion, electric shock, or to prevent property damage, personal injury, or loss of life.

### SAFETY INSTRUCTION FOR INSTALLATION (cont.)

- Rigid or semi rigid metal ducting is recommended for use between the dryer and the wall. In special installations when it is impossible to make a connection with the above recommendations, a UL-listed flexible metal transition duct may be used between the dryer and wall connection only. The use of this ducting will affect drying time.
- DO NOT use sheet metal screws or other fasteners which extend into the duct that could catch lint and reduce the efficiency of the exhaust system. Secure all joints with duct tape. ¶U For complete details, follow the Installation Instructions.

Failure to follow these instructions can result in fire or death.

Failure to follow these instructions can result in fire or death.

### SAFETY INSTRUCTION FOR CONNECTING ELECTRICITY

**⚠ WARNING** To reduce the risk of fire, electric shock or injury to persons when using the appliance, follow basic precautions, including the following :

- Do not, under any circumstances, cut or remove the ground prong from the power cord.  
To prevent personal injury or damage to the dryer, the electrical power cord must be plugged into a properly grounded
- For personal safety, this dryer must be properly grounded.  
Failure to do so can result in electrical shock or injury
- Refer to the installation instructions in this manual for specific electrical requirements for your model.  
Failure to follow these instructions can create electrical shock and/or a fire hazard.
- This dryer must be plugged into a properly grounded outlet.  
Electrical shock can result if the dryer is not properly grounded.
- Have the wall outlet and circuit checked by a qualified electrician to make sure the outlet is properly grounded.  
This will prevent shock hazard and assure stability during operating.
- The dryer should always be plugged into its own individual electrical outlet which has a voltage rating that matches the rating plate.  
This provides the best performance and also prevents overloading house wiring circuits which could cause a fire hazard from overheated wires.
- Never unplug your dryer by pulling on the power cord. Always grip plug firmly and pull straight out from the outlet.  
The power cord can be cut by any movement of the core, resulting in electrical shock.
- Repair or replace immediately all power cords that have become frayed or otherwise damaged. Do not use a cord that shows cracks or abrasion damage along its length or at either end.  
These power cord can melt, creating electrical shock and/or fire hazard.
- When installing or moving the dryer, be careful not to pinch, crush, or damage the power cord.  
This will prevent injury and damage to the dryer from fire and electrical shock.





## Part 3

# INITIAL STEPS FOR INSTALLING YOUR DRYER

The following instructions will help guide you through the initial steps of setting up your dryer for use. Please note that every section of this manual provides important information regarding the preparation and use of your dryer, and it is important that you review this entire manual before proceeding with any installation or use. More detailed instructions concerning electrical connections, gas connections, and exhaust requirements are provided in other parts of this manual.

### STEP 1 Positioning the Dryer.

Choose a location with a solid floor for your dryer. Place the dryer at least eighteen inches above the floor for a garage installation. After placing the dryer in the desired location, please make sure that it has the required clearances shown below. If you are installing your dryer in a manufactured or mobile home, please refer to STEP 9 for additional instructions.

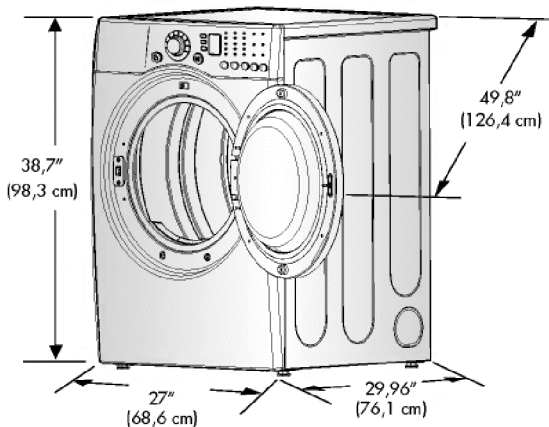

\* Most installations require a minimum 5½ inches (14 cm) clearance behind the dryer for the exhaust vent with elbow.

#### Note

Leveling legs should be secured. All four legs are stably placed on a solid and even floor. If dryer is not level, laundry may not tumble properly and sensor will not detect accurate humidity information. When leveling, please be cautious not to injure your fingers and toes. If you install the dryer on the optional pedestal, it is necessary to level with the pedestal leveling legs.

#### **Certain minimum clearances are required above, behind, and to the sides of the unit, as shown below.**

Those required minimum clearances are set forth in the picture below. Please keep the following instructions in mind when installing in a closet or recessed area:

- Consider allowing additional clearance for installation and servicing.
- Wall, door and floor molding may necessitate additional clearances.
- An additional inch of clearance is recommended to minimize noise transfer.
- Consider space needed for companion appliances.
- For closet installations, the picture below shows the minimum required ventilation openings for the door. A louvered door with comparable ventilation openings is also acceptable.

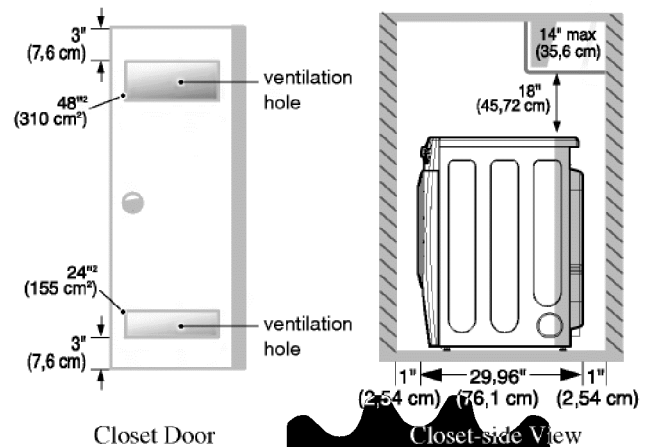

Closet Door

Closet-side View



Closet-front View

## Part 3

# INITIAL STEPS FOR INSTALLING YOUR DRYER

Once in position, adjust the leveling legs of the dryer until it is level from left to right and front to back. The leveling legs must remain firmly on the floor and the dryer should not rock. The maximum slope of the dryer from left to right or front to back should not exceed 2.5 cm (1 inch). If the dryer is not level, and if the slope exceeds 2.5 cm (1 inch), a load may not tumble properly and internal sensors may malfunction. Note: Other sections of this manual also provide important information concerning the placement of and clearances for your dryer. Please review this entire manual before proceeding with any installation.

### STEP 2 Procedure for Reversing the Door

The door on your dryer can be installed to open either to the left or the right. Follow these instructions to reverse the direction in which your door opens:

#### Note

Door and latch should be aligned at the center when closed.

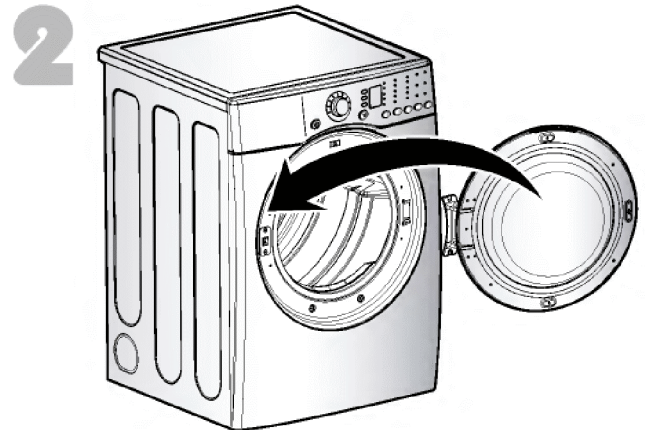
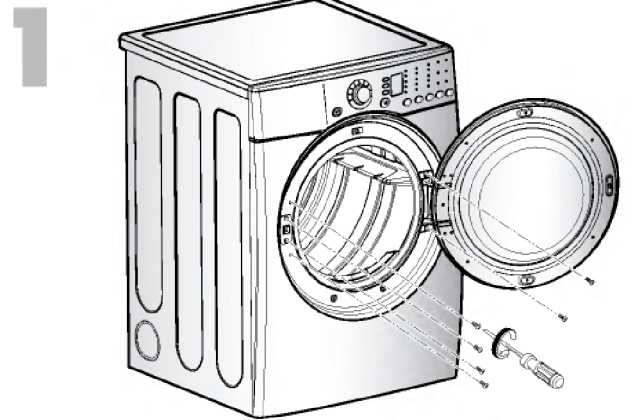

## Part 3

# INITIAL STEPS FOR INSTALLING YOUR DRYER

### STEP 3 Connecting the Exhaust and Venting System.

#### **! WARNING!**

- Use a heavy metal vent.
- Do not use plastic or thin foil duct.
- Clean old ducts before installing this dryer.
- Failure to follow these instructions can result in death or fire.

#### Note

The exhaust must be vented to the outside. Improper taping and incorrect installation will cause dryer malfunction.

In addition to the following warnings, please refer to manual section on Exhaust Requirements and Maintenance. **Warning:** The dryer must be vented to the outdoors. Please follow the instructions (and all others in this manual) very carefully. Failure to follow these instructions can result in death or fire.

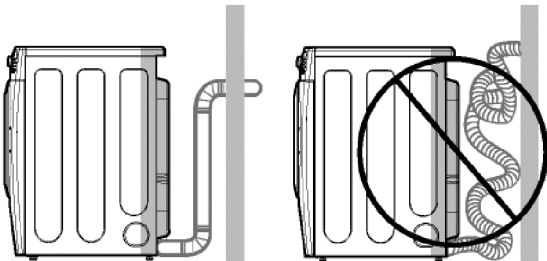

- Do not use plastic or thin foil duct.
- Use 4" (10.2 cm) diameter rigid or semi-rigid metal duct (**NOTE!** Venting materials are not supplied with the dryer, and you should obtain the venting materials necessary for proper installation)
- Position the dryer such that the exhaust duct run is as short as possible.
- *Clean old ducts before installing this dryer*
- The male end of each section of exhaust duct must point away from the dryer.
- Use as few elbow joints as possible.
- Use duct tape on all duct joints.
- Insulate ductwork that runs through unheated areas in order to reduce condensation and lint build-up on pipe walls.
- **PLEASE BE AWARE THAT FAILURE TO EXHAUST THE DRYER CORRECTLY WILL VOID THE DRYER'S WARRANTY.**

### ■ ALTERNATE EXHAUST DIRECTIONS

1. Remove screw and exhaust duct.  
(Use exhaust kit part #3911EZ9131X.)

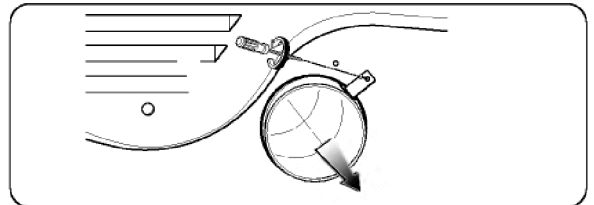

- 2-1. Detach and remove the knockout that matches the desired venting direction  
(Right side not available on Gas Dryers)

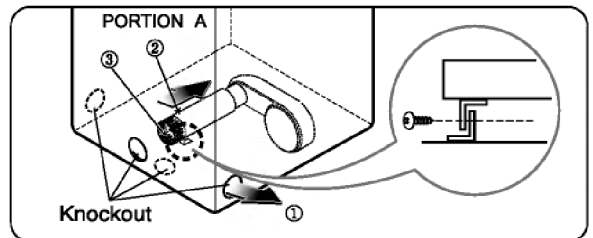

- 2-2. Connect a short piece of duct to the blower housing and attach the duct to the base.

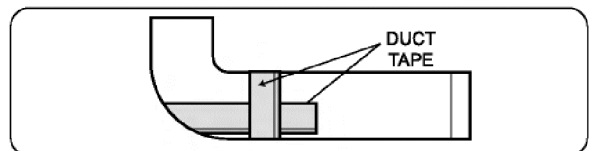

- 3-1. Insert the male end of a 4" elbow into the female end of a short duct. Tape the joint.

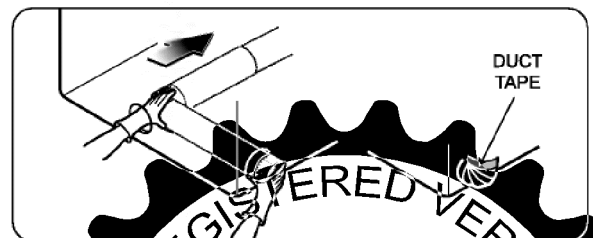

- 3-2. Insert this assembly elbow first through the hole in the dryer and push the female end of the elbow onto the male end of the blower output shaft. Tape the joint.

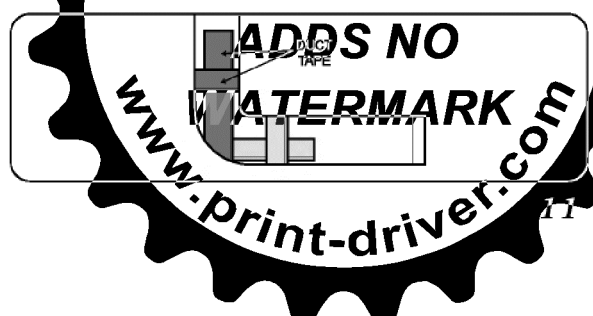

**STEP 4 Connection of Gas Supply**

(Gas dryer only). In addition to the following, please refer to manual section on Gas Requirements and Instructions.

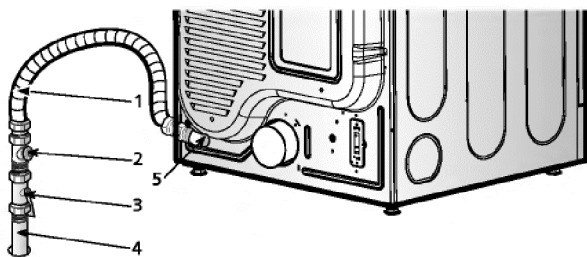

1. New stainless steel flexible connector. Use this type of connector only if allowed by local codes. Use Design AGA Certified Connector.
2. 1/8" NPT Pipe Plug (for checking inlet gas pressure)
3. Equipment Shut-Off Valve  
Installed within 6' (1.8 m) of dryer.
4. Iron Pipe. Shorter than 20' (6.1 m)  
Use 3/8" pipe.  
Longer than 20' (6.1 m) - Use 1/2" pipe.
5. 3/8" N.P.T. Gas Connection.

**Note**

**Make sure the burner orifice is proper for the type of gas you have.**

**For instance, using LPG with LNG orifice will result in death, fire or explosion. Or using LNG with LPG nozzle will not allow the burner to ignite.**

**If needed, orifice conversion should be done by a qualified service technician and mark or put the label of the current type of orifice on the dryer. If changing the orifice, also adjust the gas valve.**

1. Confirm that the type of gas available in your laundry room is appropriate for the dryer. The dryer is prepared for Natural Gas with a 3/8" NPT gas connection.
2. Remove the shipping cap from the gas connection at the back of the dryer. Make sure that you don't damage the threads of the gas connection pipe when you remove the shipping cap.
3. Connect the dryer to your laundry room's gas supply using a new flexible stainless steel connector (as noted below, use a new stainless steel flexible connector if allowed by your local codes).
4. Securely tighten all connections between the dryer and your laundry room's gas supply. Turn on your laundry room's gas supply and check all pipe connections (both internal and external) for gas leaks with a non-corrosive leak detection fluid. Refer to Part 7 (page 20)
5. For LP (Liquefied Petroleum) gas connection, refer to this manual's section entitled Gas Requirements and Instructions.

12

**STEP 5 Electrical Plug Connections**

Following are several warnings and instructions concerning making the electrical connection for electric dryers. More detailed information concerning the electrical connection is provided in the manual section entitled Electrical Requirements for Electric Dryer. It is important that you thoroughly review that section and the remainder of this manual, before taking any steps to install or use this dryer.

1. Use only a new UL listed No. 10 (copper wire only) three conductor power supply cord kit rated 240 Volts (minimum) 30 Amperes and labeled as suitable for use in a clothes dryer.
2. A four-wire cord is required for manufactured (mobile) home installations and where local codes do not allow grounding of this appliance through neutral.
3. Electrical Plug Connections.
4. For additional instruction on connecting the dryer to an electrical power source, please refer to this manual's section on Electrical Requirements and Electric Dryer.

**Note****Burner input requirements**

If your house is located at the elevations up to 10,000 feet.

Adjusting burner input setting is not needed at this elevation because AGA certifies this dryer will not have any problem with the BTU rating at this altitude.

If your house is above 10,000 feet, you are required to adjust a four percent (4%) reduction of the burner BTU rating indicated on the model/serial rating plate.

**! WARNING!**

- Use a new UL listed 30 amp power supply cord.
- Use a UL approved strain relief.
- Disconnect power before making electrical connections.
- Connect neutral wire (white or center wire) to center terminal.
- Ground wire (green or bare wire) must be connected to green ground connector.
- Securely tighten all electrical connections.
- See installation instructions for complete instructions.
- Failure to do so can result in fire or electrical shock.

**STEP 6 Preparation of the Dryer.**

Prior to the first use of this appliance, use all-purpose cleaning products or a solution of detergent and water, with damp cloth to remove from the inside of the dryer drum/drying compartment any dust or dirt that may have accumulated inside the dryer. Plug-in your dryer after reviewing the following parts on your dryer's Electrical Requirements.

**STEP 7 Confirming Heat Source Operation.****Confirming Heat Source in Gas Dryers**

Close the door to the dryer drum/drying compartment and, after completing all steps in this manual for proper installation of this dryer, start the dryer on a heat setting. After the dryer starts, the igniter will glow red and the main burner will ignite.

**Warning:** If all air is not purged from the gas line, the gas igniter may go off before the gas and the main burner have ignited. If this happens, the igniter will re-attempt gas ignition after approximately two minutes.

**Confirming Heat Source in Electric Dryers**

Close the door to the dryer drum/drying compartment and, after completing all steps in this manual for proper installation of this dryer, start the dryer on a heat setting. The exhaust air or the exhaust pipe should be warm after the dryer has been operating for three minutes.

**STEP 8 Dryer Airflow.**

Effective dryer operation requires appropriate dryer airflow. The adequacy of the airflow can be measured by evaluating the static pressure. Static pressure in the exhaust duct can be measured with a manometer, placed on the exhaust duct approximately 2 ft. (60.9 cm) from the dryer. Static pressure in the exhaust duct should not exceed 5/8 inches (1.5 cm). The dryer should be checked while the dryer is running with no load.

Measuring Static pressure

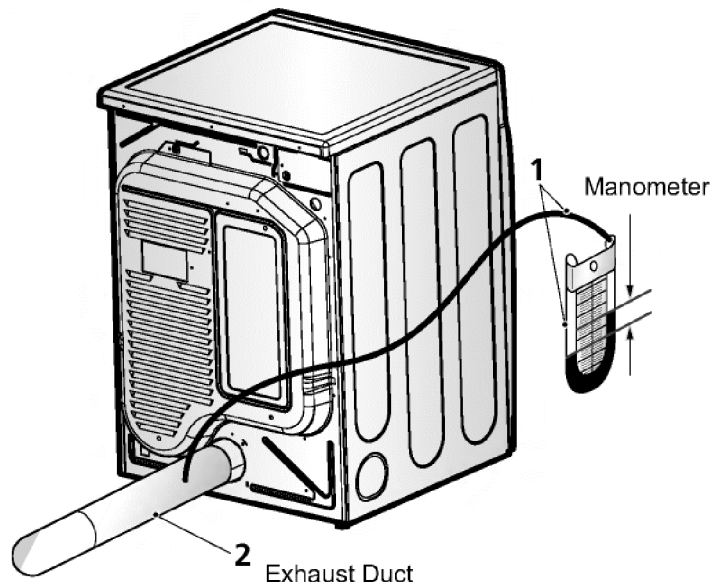

### STEP 9 Additional Instructions for Installation of Your Dryer in a Manufactured or Mobile Home.

The following instructions are applicable to installations of the dryer in a manufactured or mobile home. Any installation in a manufactured or mobile home must comply with the Manufactured Home Construction and Safety Standards Title 24 CFR, Part 32-80 or Standard CAN/CSA0Z240 MH and local codes and ordinances. If you are uncertain whether your proposed installation will comply with these standards, please contact a service and installation professional for assistance.

The following instructions apply to any installation of the dryer in a manufactured or mobile home:

- 1) The electrical connection for an electric dryer must be a 4-wire connection. More detailed information concerning the electrical connection is provided at the manual section entitled Electrical Requirements for Electric Dryer
- 2) To reduce the risk of combustion and fire, the dryer must be vented to the outside.
- 3) Electric dryers may be vented to the outside using the back, left, right, or bottom panel.
- 4) Gas dryers may be vented to the outside using the back, left, or bottom panel. Gas dryers may not be vented to the outside using the right side panel because of the burner housing.
- 5) The dryer exhaust duct must be affixed securely to the manufactured or mobile home structure, the exhaust duct must be made of a material that will resist fire and combustion, and it is recommended that you use a rigid or flexible metal pipe.
- 6) DO NOT connect the exhaust duct with any other duct, vent, chimney, or other exhaust duct.
- 7) Make sure the dryer has adequate access to outside fresh air to ensure proper operation. The opening for outside fresh air must be at least 25 in<sup>2</sup> (163 cm<sup>2</sup>).
- 8) It is important that the clearance of the duct from any combustible construction be at least 2 inches (5 cm), and, when venting the dryer to the outdoors, the dryer can be installed with a clearance of 1 inch at the sides and back of the dryer.
- 9) Please be aware that venting materials are not supplied with the dryer. You should obtain the venting materials necessary for proper installation.

#### **! WARNING!**

- DO NOT connect exhaust ducts with metal screws or fasteners that extend into the duct.
- Failure to do so can result in death, explosion, or fire.

#### **! WARNING!**

- DO NOT vent the exhaust duct under the manufactured or mobile home.
- Failure to do so can result in death, explosion, or fire.



**Stacking Kit Installation Instructions**

To ensure safe and secure installation, please observe the instructions below.

**⚠ WARNING!**

- The weight of the dryer and the height of installation makes the stacking procedure too risky for one person. This procedure should be performed by 2 or more experienced service personnel.
- Incorrect installation can cause serious accidents.

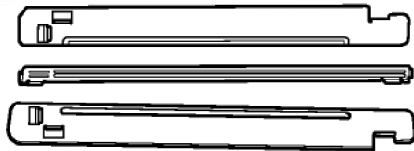

Stacking kit

**1** Place washer firmly on a stable, even and solid floor.

**2** Peel protective paper off the tape from the stacking kit side bracket.



**3** Fit the stacking kit side bracket firmly to the side of top plate by attaching the double-sided tape to top plate as picture shows.

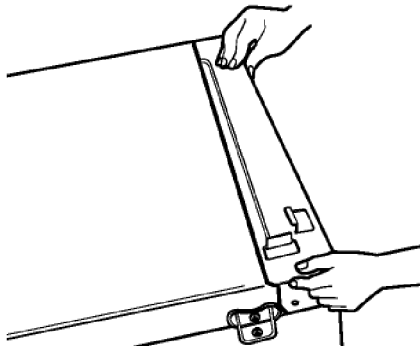

**Note**

Clean the surface before attaching the brackets and double-sided tape.

**4** Secure stacking kit side bracket to the washer with a screw on the back of bracket. Repeat Steps 2, 3, 4 for the other side.

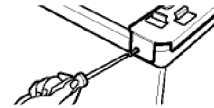

**5** Place the dryer on top of the washer by fitting legs as shown in the picture. Avoid finger injuries - be careful not to pinch fingers between the washer and dryer. Slide dryer slowly backwards to the stopper of kit.

**⚠ WARNING!**

- Do not stack a washer on the top of the dryer.
- Incorrect installation can cause serious accidents.

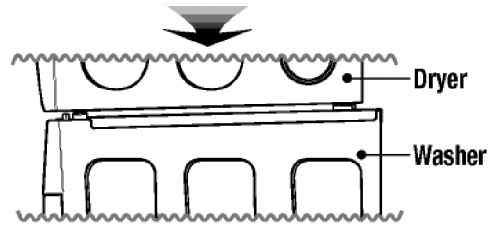
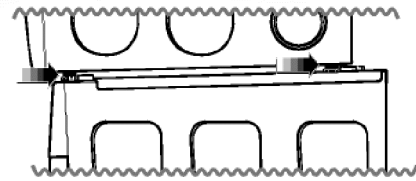

**6** Insert the front rail. Push the front rail back to the stoppers of side stacking kit.

**7** Attach both sides of the front kit with screws.



- Do not use stacking kit with a gas dryer in potentially unstable conditions like a mobile home.

**Pedestal Installation Instructions**

**1** Remove pedestal, installation hardware, and instructions from the shipping carton.

**2** Position dryer on top of the pedestal.  
**NOTE :** Because of the weight of the dryer two or more people may be needed.

**NOTE :** If dryer was previously installed, uninstall it as follows:

**A. Uninstalling an electric dryer:**

- 1) Unplug the power supply cord,
- 2) Pull the dryer away from the wall enough to loosen the vent clamp. Loosen the clamp and carefully remove the exhaust vent from the dryer exhaust outlet.

**B. Uninstalling a gas dryer:**

- 1) Shut off gas.
- 2) Unplug power cord.
- 3) Disconnect gas line from dryer.
- 4) Pull away and loosen vent clamp.
- 5) Disconnect venting.

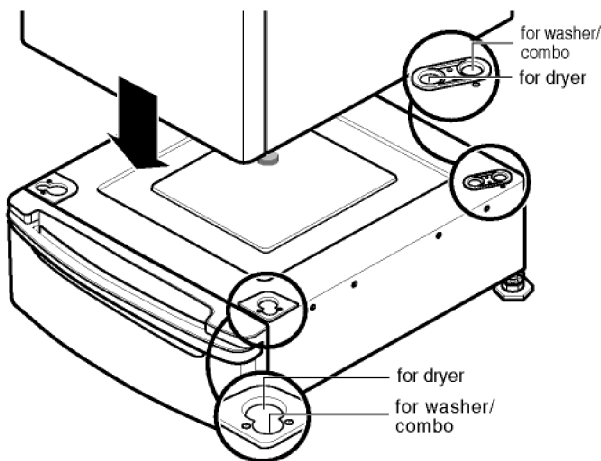

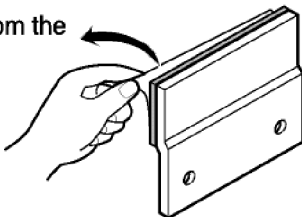
**3** Remove the paper from the bracket.  

**4** Attach the double-faced tape of the bracket to the dryer as shown so the bent parts of the brackets align with the edge and can be attached to the pedestal with screws.  
**NOTE :** Attach the bottom first.

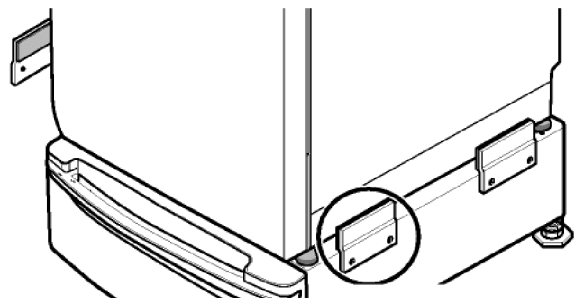

**5** Be sure to press the adhesive parts of the brackets firmly to the appliance.

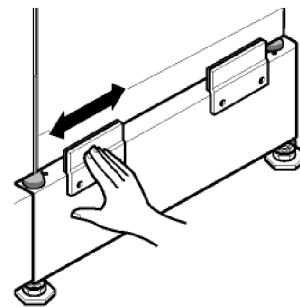

**6** Install the eight (8) screws (supplied) to attach the brackets to the pedestal.



**7** Move the dryer to the best place.  
**NOTE :** The appliance and pedestal assembly must be placed on a solid and level floor for proper operation. Adjust the legs of the appliance and pedestal by turning with a wrench. Then, adjust the locknut toward the pedestal while holding the pedestal leg using a wrench.



The following are additional instructions regarding electrical connections and requirements for electric dryers.

**⚠ Warning:** The wiring and grounding must conform to the latest edition of the National Electrical Code, ANSI/NFPA 70 and all applicable local regulations. Please contact a qualified electrician to check your home's wiring and fuses to ensure that your home has adequate electrical power to operate the dryer. Failure to do so can result in fire or electrical shock.

120V~127V / 240V, 60 Hertz, 3-Wire Installation

### Instructions for Grounding of your Electric Dryer:

- a) This dryer must be connected to a grounded metal, permanent wiring system or an equipment-grounding conductor must be run with the circuit conductors and connected to the equipment-grounding terminal or lead on the dryer.
- b) The dryer has its own terminal block that must be connected to a separate 60 Hertz single phase AC circuit, fused at 30 Amperes (the circuit must be fused on both sides of the line). **ELECTRICAL SERVICE FOR THE DRYER SHOULD BE OF MAXIMUM RATE VOLTAGE LISTED ON THE NAMEPLATE. DO NOT CONNECT DRYER TO 110, 115, OR 120 VOLT CIRCUIT.** Heating elements are available for field installation in dryers which are to be connected to electrical service of different voltage than that listed on nameplate.
- c) If branch circuit to dryer is fifteen feet (4.50 m) or less in length, use U.L. (Underwriters Laboratories) listed No. 10 A.W.G. wire (copper wire only), or as required by local codes. If over fifteen feet (4.50 m), use U.L. (Underwriters Laboratories) listed No. 8 A.W.G. wire (copper wire only), or as required by local codes. Allow sufficient slack in wiring so dryer can be moved from its normal location when necessary.
- d) The power cord (pigtail) connection between wall receptacle and dryer terminal block IS NOT supplied with dryer. Type of pigtail and gauge of wire must conform to local codes and with instructions mentioned on the following pages.
- e) The method of wiring the dryer is optional and subject to local code requirements. Refer to examples on next page.
- f) You must select the method by which to wire your dryer according to local code and ordinance requirements. Sample methods are included in the following pages.



Review the following options to determine the appropriate electrical connection for your home:



**4-wire receptacle  
(NEMA type 14-30R)**

Use the instructions in this section if your home has a 4-wire receptacle (NEMA type 14-30R) and you will be using a UL listed, 120/240 volt minimum, 30 amp, dryer power supply cord.



**3-wire receptacle  
(NEMA type 10-30R)**

Use the instructions in this section if your home has a 3-wire receptacle (NEMA type 10-30R) and you will be using a UL listed, 120/240 volt minimum, 30 amp, dryer power supply cord.

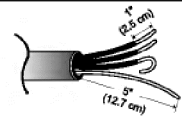

**4-wire direct**

If this type is available at your home, you will be connecting to a fused disconnect or circuit breaker box.

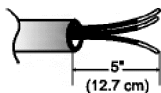

**3-wire direct**

If this type is available at your home, you will be connecting to a fused disconnect or circuit breaker box.

**Note**

- Connect the power supply wire to the terminal block. Colored wire should be connected to same color screw. Wire color indicated on manual is connected to the same color screw in block. Otherwise, a short or excessive current flow may result.

**4-wire connection : Direct wire**

**Warning :** Grounding through the neutral conductor is prohibited for (1) new branch-circuit installations, (2) mobile homes, (3) recreational vehicles, and (4) areas where local codes prohibit grounding through the neutral conductor. Failure to do so can result in fire or electrical shock.

Prepare minimum 5 ft (1.52 m) of length in order for dryer to be replaced.

First, peel 5 inches (12.7 cm) of covering material from end. Strip 5 inches of ground wire insulation. After cutting 1 1/2 inch (3.8 cm) from 3 other wires peel insulation back 1 inch (2.5 cm). Make ends of 3 wires a hook shape.

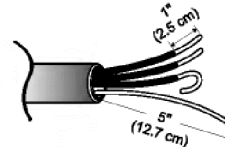

Then, put the hooked shape end of the wire under the screw of the terminal block (hooked end facing to the right) and pinch the hook together and screw tightly.

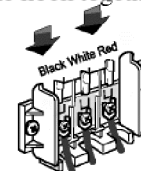

1. Connect neutral wire (white) of power cord to center terminal block screw.
2. Connect red and black wires to the left and right terminal block screws.
3. Connect ground wire (green) of power cord to external ground screw and move neutral ground wire of appliance and connect it to center screw.
4. Make sure that the strain relief screw is tightened. Be sure that all terminal block nuts are on tight and power cord is in right position.

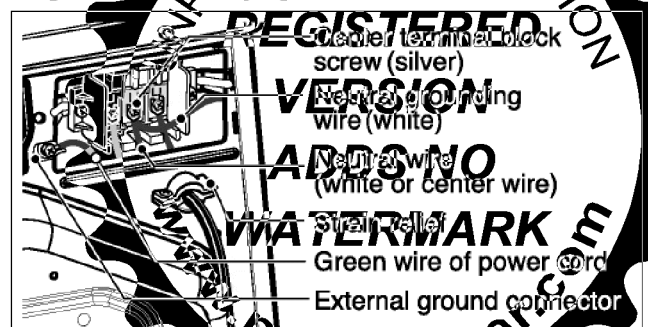

## Part 5

# ELECTRICAL REQUIREMENTS FOR ELECTRIC DRYERS

### 3-wire connection : Direct wire

**Warning :** Grounding through the neutral conductor is prohibited for (1) new branch-circuit installations, (2) mobile homes, (3) recreational vehicles, and (4) areas where local codes prohibit grounding through the neutral conductor. Failure to do so can result in fire or electrical shock.

Prepare minimum 5 ft (1.52 m) of length in order for dryer to be replaced.

First, strip 3 1/2 inches (8.9 cm) of outer sheath from end and strip 1 inch of insulation from each conductor.

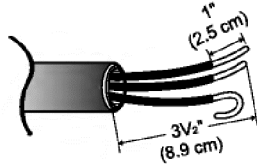

Then, put the hooked shape end of the wire under the screw of the terminal block (hooked end facing rightward) and pinch the hook together and tighten the screw securely.

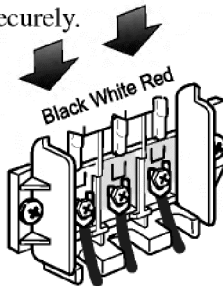

1. Connect neutral wire (white) of power cord to center terminal block screw.
2. Connect red and black wires to the left and right terminal block screws.
3. Make sure that the strain relief screw is tightened. Be sure that all terminal block nuts are on tight and power cord is in right position.

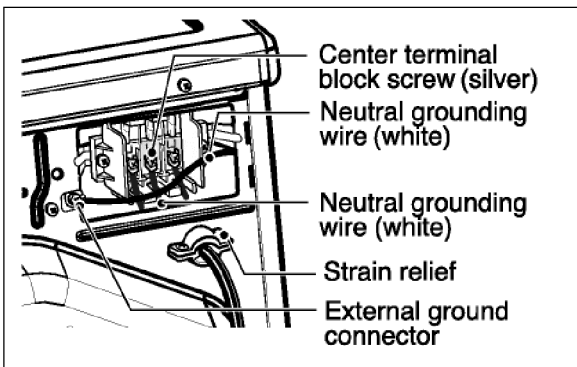

### Option 1: 4-wire connection with a power supply cord.

- If your local codes or ordinances do not allow the use of a 3-wire connection, or you are installing your dryer in a mobile home, you must use a 4-wire connection.

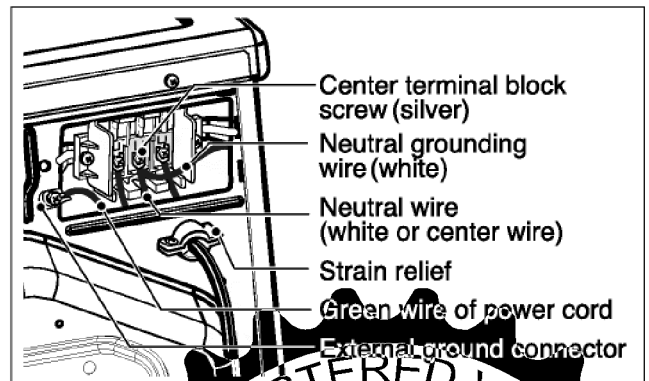
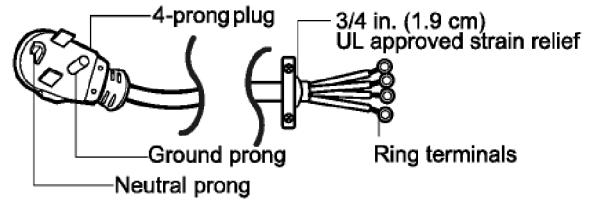
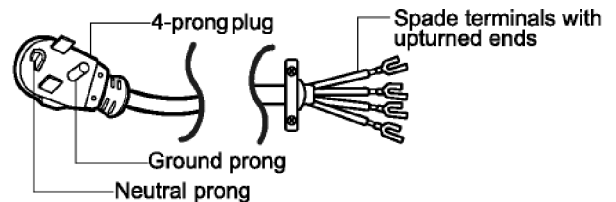
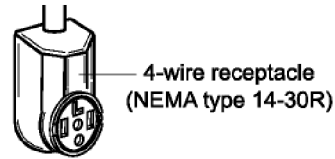

1. Connect neutral wire (white) of power cord to center terminal block screw.
2. Connect red and black wires to the left and right terminal block screws.
3. Connect ground wire (green) of power cord to external ground screw and move neutral ground wire of appliance and connect it to center screw.
4. Make sure that the strain relief screw is tightened. Be sure that all terminal block nuts are on tight and power cord is in right position.

**Option 2: 3-Wire connection with a power supply cord.**

If your local codes or ordinances permit the connection of a frame-grounding conductor to the neutral wire, use these instructions. If your local codes or ordinances do not allow the connection of a frame-grounding conductor to the neutral wire, use the instructions under Section 1: Optional 3-wire connection.

**Section 1**

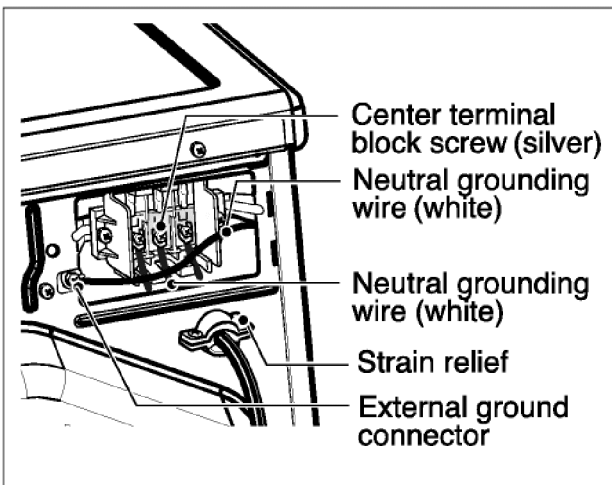
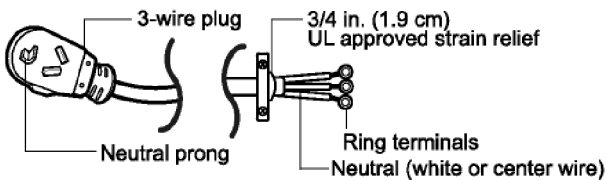
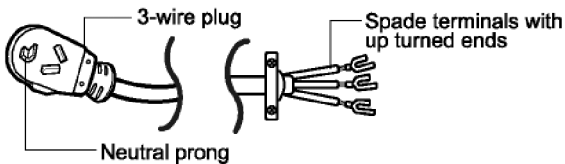
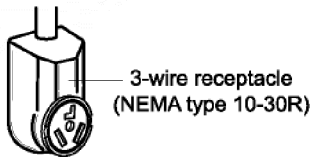

**Option 3: Optional 3-wire connection.**

- If your local codes or ordinances do not allow the connection of a frame-grounding conductor to the neutral wire, use the instructions under this section.

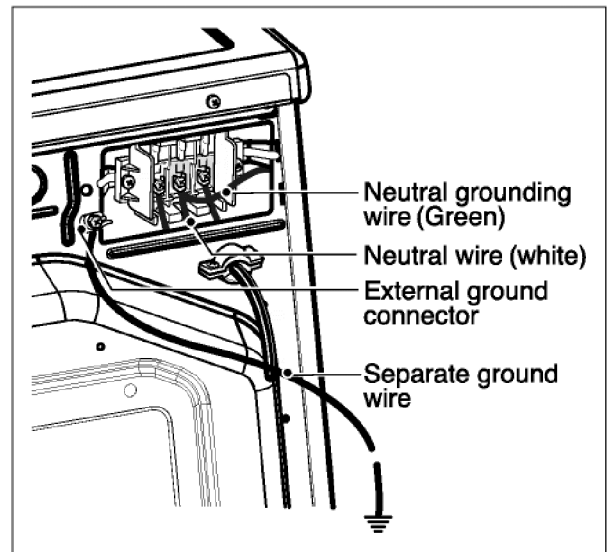
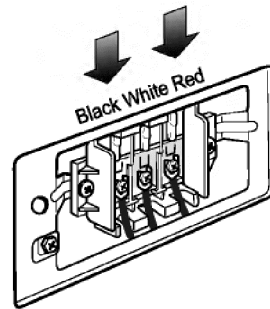

1. Connect neutral wire (white) of power cord to center terminal block screw.
2. Connect ground wire of appliance and neutral wire of power cord to center terminal block screw.
3. Connect red and black wires to the left and right terminal block screws.
4. Make sure the strain relief screw is tightened. Be sure that all terminal block nuts are on tight and power cord is in tight position.
5. Connect a independent ground wire from external ground connector to proper ground.



**120~127 Voltios, 60 Hz con Enchufe de 3-Clavijas con Conexión a Tierra**

Las siguientes son instrucciones adicionales sobre las conexiones y requerimientos eléctricos para las secadoras a gas.

**⚠ Advertencia:** El cableado y la conexión a tierra deben estar de acuerdo con la edición más reciente del código Eléctrico Nacional, ANSI/NFPA 70, o el Código Eléctrico Canadiense, CSA C22.1, y todas la regulaciones locales aplicables. Por favor contacte un electricista calificado para verificar el cableado y fusibles de su casa y asegurar que tiene la energía eléctrica adecuada para el funcionamiento de la secadora. De no seguir estas advertencias puede resultar en incendio o choque eléctrico.

**Requerimientos Eléctricos para su Secadora:!**

- a) Recuerde que el diagrama de cableado se encuentra dentro de la caperuza de control de la secadora. Etiquete todos los cables antes de la desconexión al realizar tareas de servicio porque errores en el cableado pueden ser causa de serias lesiones para usted y para su secadora.
- b) Su secadora está diseñada para ser operada en un circuito separado, polarizado, de tres alambres efectivamente conectados a tierra, 120 Voltios, 60 Hertz, AC (corriente alterna) circuito protegido por un fusible de 15 Amperios, fusetrón equivalente o disyuntores.
- c) Utilice circuitos de fusibles separados para la lavadora y la secadora, NO opere una lavadora y una secadora en el mismo circuito.

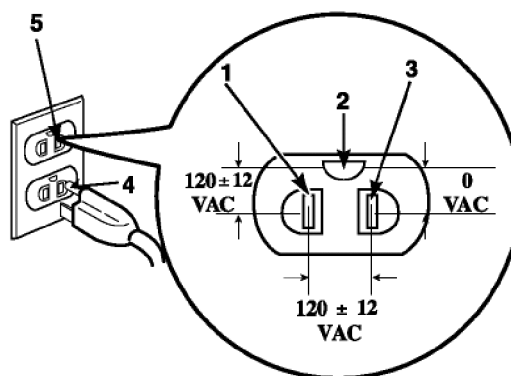

**CIRCUITO ESTÁNDAR DE 120 VOLT, 60 HERTZ, 3-ALAMBRES EFECTIVAMENTE CONECTADO A TIERRA.**

- 1 L1
- 2 Tierra
- 3 Lado Neutral
- 4 Clavija Redondeada a Tierra
- 5 Neutral

- a) La secadora tiene un enchufe de tres clavijas para protección contra choques eléctricos. El enchufe debe ser conectado directamente a un tomacorriente para tres clavijas debidamente conectado a tierra clasificado para 120 Voltios AC (corriente alterna) 15 Amperios. Este enchufe, para que sea debidamente y completamente efectivo, debe estar enchufado en un tomacorriente debidamente instalado que esté conectado a tierra de acuerdo a todos los códigos y ordenanzas locales.
- b) La secadora debe estar conectada a tierra con el fin de reducir el riesgo de choques eléctricos, incluyendo mal funcionamiento o avería.
- c) Si su cuarto de lavado no cumple con las especificaciones requeridas por este manual, o si no está seguro de que su cuarto de lavado cumple con estas especificaciones, por favor haga que un técnico o compañía calificada, por ejemplo un electricista calificado o su compañía eléctrica local, verifique el suministro eléctrico de su cuarto de lavado y corrija cualquier problema.

**⚠ ADVERTENCIA!**

- No sobrecargue el circuito operando otros artefactos en el mismo circuito cuando este artefacto está funcionando, utilizando una extensión eléctrica para conectar la secadora a la fuente de energía, o utilizando cualquier adaptador que permita que se conecten cordones adicionales al mismo tomacorriente.
- De no seguir estas advertencias puede resultar en incendio o choque eléctrico.!

**⚠ ADVERTENCIA!**

- **NO modifique el enchufe provisto con la secadora.** Si éste no encaja en el tomacorriente de su cuarto de lavado, un tomacorriente adecuado necesitará ser instalado por un técnico o compañía calificada.
- De no seguir estas advertencias puede resultar en incendio o choque eléctrico.!



Following are important instructions and information concerning the requirements for the gas supply and service for gas dryers. **⚠ Warning:** The gas supply and service for a gas dryer must comply with all local codes and ordinances. In the absence of any local codes or ordinances in your area, the gas supply and service for your gas dryer must comply with the latest edition of the National Fuel Gas Code, ANSI Z223.1/NFPA 54. Failure to do so can result in death, explosion, or fire.

1. Gas supply requirements: Liquefied Petroleum (L.P.) Gas (2,500 Btu/ft<sup>3</sup> (93.1 MJ/m<sup>3</sup>)) service must be provided at 10 + 1.5 in. water column pressure.
2. Do not attempt to connect the dryer to Liquefied Petroleum (LP Gas) Gas service without a qualified professional.
3. Isolate the dryer from the gas supply piping system by closing its individual manual shut-off valve during any pressure testing of the gas supply system at test pressure equal to or less than 2/1 psi (3.45 kPa).
4. Supply Line Requirements. Your laundry room must have a rigid gas supply line to your dryer. In the United States, an individual manual shutoff valve **MUST** be installed within at least 6 feet (1.8 m) of the dryer, in accordance with the National Fuel Gas Code ANSI Z223.1. A 1/8 in. N.P.T. pipe plug must be installed as shown.
5. If using a rigid pipe, the rigid pipe should be 1/2 inch IPS. If acceptable under local codes and ordinances and when acceptable to your gas supplier, 3/8 inch approved tubing may be used where lengths are less than 20 feet (6.1 m). Larger tubing should be used for lengths in excess of 20 feet (6.1 m). It is also important that you use pipe joint compound that is insoluble in LP gas.
6. To reduce the danger of gas leaks, explosion, and fire, please follow and observe the following **instructions and WARNINGS**.
  - Connect the dryer to the type of gas shown on the nameplate.
  - Use new flexible stainless steel connectors.
  - Use Teflon tape and pipe joint compound insoluble in LP gas on all pipe threads.
  - Purge gas supply of air and sediment before connecting the gas supply to the dryer in order to prevent gas valve contamination. Before tightening connection between gas supply and dryer, purge remaining air until odor of gas is identified.
  - **DO NOT** use an open flame to inspect for gas leaks; instead use a non-corrosive leak detection fluid.

### **⚠ WARNING!**

- **DO NOT** attempt any disassembly of the dryer. Any disassembly requires the attention and tools of an authorized and qualified service person or company.
- Failure to do so can result in death, explosion, or fire.

### **⚠ WARNING!**

- Use a new AGA or CSA approved gas supply line.
- Install a shut-off valve.
- Securely tighten all gas connections.
- If connected to LP, have a qualified person make sure gas pressure does not exceed 13 in. water column.
- Examples of a qualified person include licensed heating personnel, authorized gas company personnel, and authorized service personnel.
- Failure to do so can result in death, explosion, or fire.

## Part 8

# EXHAUST REQUIREMENTS AND MAINTENANCE

Following are important instructions and information concerning the exhaust requirements for your dryer.

**⚠ Warning:** DO NOT exhaust dryer air into an enclosed and unventilated area, such as an attic, wall, ceiling, crawl space, chimney, gas vent, or concealed space of a building. To reduce the risk of fire, DO NOT exhaust the dryer with plastic or thin foil Ducting. Failure to do so can result in death, explosion, or fire.

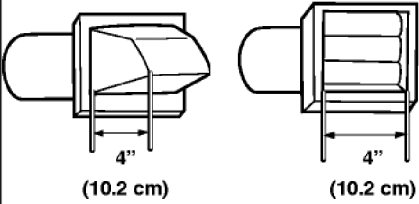
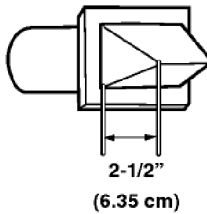
Weather Hood Type	Number of 90° Elbows	Maximum length of 4" (10.2 cm) diameter rigid metal duct	Maximum length of 4" (10.2 cm) diameter flexible metal duct
<b>Recommended</b> 	0	65 feet (19.8 m)	45 feet (13.7 m)
	1	55 feet (16.8 m)	35 feet (10.7 m)
	2	47 feet (14.3 m)	30 feet (9.1 m)
	3	36 feet (11.0 m)	25 feet (7.6 m)
	4	28 feet (8.5 m)	20 feet (6.1 m)
<b>Use Only for Short Run Installations</b> 	0	55 feet (16.8 m)	35 feet (10.7 m)
	1	47 feet (14.3 m)	27 feet (8.2 m)
	2	41 feet (12.5 m)	21 feet (6.4 m)
	3	30 feet (9.1 m)	17 feet (5.2 m)
	4	22 feet (6.7 m)	15 feet (4.5 m)

**NOTE :** Deduct 6 feet (1.8 m) for each additional elbow.  
It is not recommended to use more than 4 90° elbows.

### Exhaust Requirements and Instructions:

- Venting materials are not provided with the dryer and you should obtain the necessary venting materials locally. For example, the outer end of exhaust pipe must have a weather hood with hinged dampers to prevent back-draft when the dryer is not in use.
- The exhaust duct must be four inches (10.2 cm) in diameter with no obstructions. The exhaust duct should be kept as short as possible. Make sure to clean any old ducts before installing your new dryer.
- Rigid or semi-rigid metal ducting is recommended for use as transition ducting between the dryer and the wall. In special installations when it is impossible to make a connection with the above recommendations, then a UL-listed flexible metal transition duct may be used between the dryer and wall connection only. The use of this ducting will affect dry time.
- DO NOT use sheet metal screws on exhaust pipe joints or other fastening means which extend into the duct that could catch lint and reduce the efficiency of the exhaust system. Secure all joints with duct tape.
- To maximize operating results, please observe the duct length limitations noted in the chart above.

## Exhaust and Dryer Maintenance

**⚠ WARNING!**

- Disconnect the dryer's electric power prior to any cleaning or maintenance.
- Failure to do so can result in fire or electrical shock.

1. After one year of use, the interior and complete exhaust system of the dryer should be examined and cleaned if necessary.
2. Before one year of use, when drying performance has become unsatisfactory, please examine and clean the exhaust duct for better drying performance.
3. Check the weather hoods frequently to ensure the dampers are moving freely, that the dampers are not pushed in and that nothing has been set against the dampers.
4. A qualified service person or company should be used to perform this maintenance.
5. A Flexible Metal Vent Kit, available at extra cost, can be used to exhaust the dryer when it is placed in hard to reach places. This Kit comes in two pieces, one of which is attached to the dryer and the other is attached to the wall exhaust outlet. Following attachment of the two separate pieces to the dryer and the wall, the dryer may be returned to its final position, after which the two pieces themselves can be connected.
7. Ordinarily, the dryer drum will need no care. Wipe the exterior of the dryer as required, and always wipe the exterior of the dryer in the event any detergent, bleach, or other washing products is spilled on the dryer.
8. Clean the control panel with a damp cloth as necessary. **Warning:** spray pre-wash products may damage the finish of the control panel.
9. Please clean the lint filter either before drying each load or after drying each load.
10. Always make sure the lint filter is clean before starting a new load, because a clogged lint filter may increase drying times.
11. Annually remove the lint filter and attach it to the vacuum duct. See item #2 above.
12. Please note that the wiring diagram is provided inside the dryer control hood. Label all wires prior to disconnection when servicing the dryer, because wiring errors can cause serious injury to you and your dryer.

## Cleaning the Lint Screen

1. Clean the lint filter either before drying each load or after drying each load. Always make sure the lint filter is clean before starting a new load, because a clogged lint filter may increase drying times.
2. To clean, pull the lint screen straight up and roll any lint off the screen with your fingers. Do not rinse or wash screen to remove lint. Push the lint screen firmly back into place.
3. Always ensure the lint screen is firmly secured before running the dryer. Running the dryer with a loose lint screen may cause overheating and damage to the dryer and articles being dried.
4. Some articles of clothing may shed more lint than others (towels for example), causing the lint screen to fill rapidly. Remove lint from the lint screen before and after drying these articles, such as new towels.
5. In the event lint falls off of the lint screen and into the dryer during removal, inspect the exhaust hood and remove any lint.
6. Laundry detergent and fabric softener residue can build up on the lint screen, causing longer drying times. The screen is likely blocked if lint falls off the screen. In order to prevent this type of build up, and help ensure proper operation of your dryer, clean the lint screen with a nylon brush every six months or, if necessary, more frequently. The lint filter can also be washed as follows:
  - a) After rolling the lint off of the screen with your fingers, wet both sides of the screen with hot or warm water.
  - b) Wet a nylon brush with hot water and liquid detergent and scrub the lint screen with the brush to remove the buildup of detergent and fabric softener.
  - c) After the residue has been removed, rinse screen with hot water.
  - d) After drying the lint screen with a clean towel, firmly replace the lint screen in your dryer.





## Part 9

# OPERATING YOUR DRYER

Following are instructions for starting and using your new dryer. Please refer to specific sections of this manual for more detailed information. Important Warning: To reduce the risk of fire, electric shock, or injury to person, read this entire manual, including the **IMPORTANT SAFETY INSTRUCTIONS**, before operating this dryer.

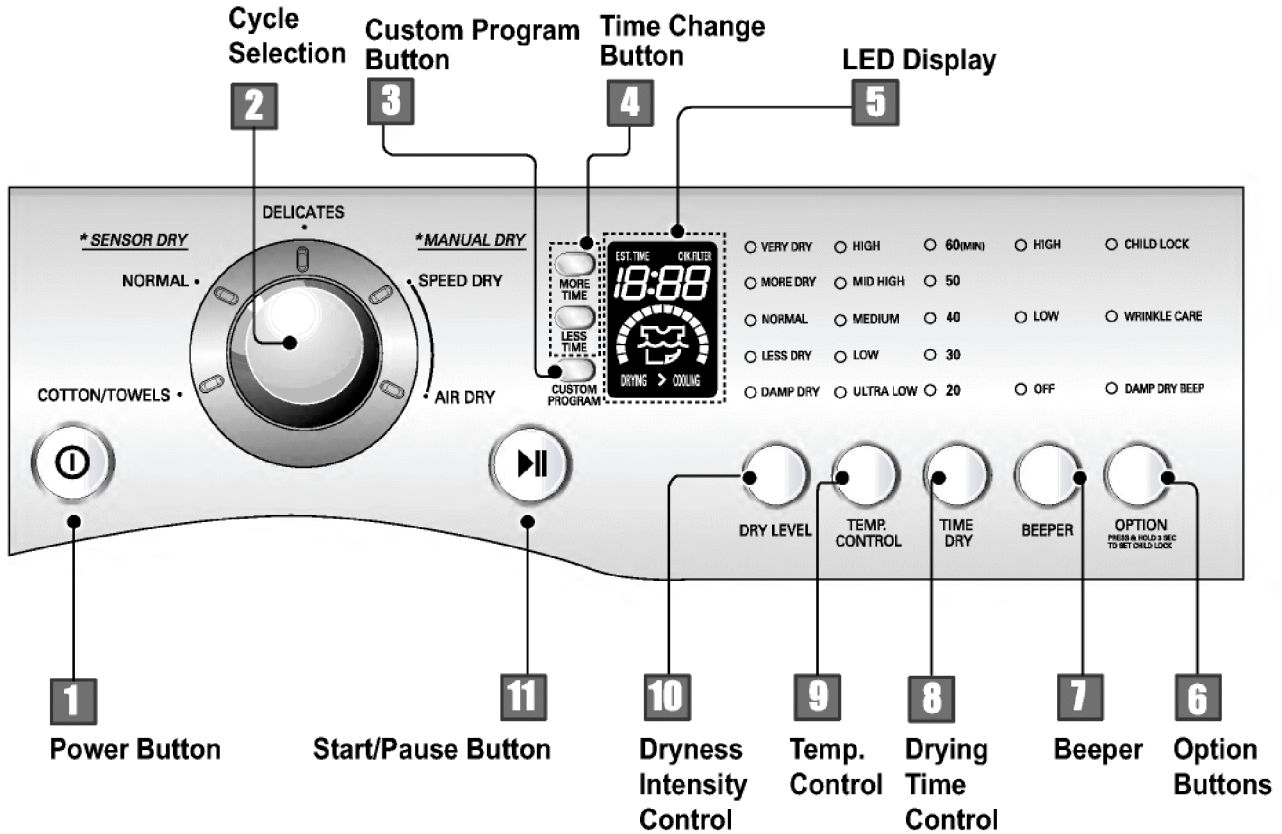

### **!WARNING!**

#### Fire Hazard

- No washer can completely remove oil.
- Do not dry anything that has ever had any type of oil on it (including cooking oils).
- Items containing foam, rubber, or plastic must be air dried.
- Failure to follow these instructions can result in death or fire.

### **!WARNING!**

#### Explosion Hazard

- Keep flammable materials and vapors, such as gasoline, away from dryer.
- Do not dry anything that has ever had anything flammable on it (even after washing).
- Failure to follow these instructions can result in death, explosion, or fire.

### **1** Power Button

- Use this button for power on or off.



## 2 Cycle Selection

- Turn the knob to select the desired cycle based on laundry types and conditions.

### 1. Sensor Dry Cycles

Sensor Dry Cycles allow you to match the cycle to the load you are drying. Each cycle dries certain fabrics at the recommended temperature. A sensor detects the moisture in the load and automatically adjusts the drying time for optimal drying

#### Cotton/Towels

Use for drying denims, towels, heavy cottons.

#### Normal

Use for drying sturdy fabrics such as work casual clothes.

#### Delicates

Use for drying synthetic fabrics, washable knit fabrics and no-iron finishes.

Sensor Dry Preset Cycle Settings		
Sensor Dry Cycles Load Type	Temp.	Time* (Minutes)
<b>COTTON/TOWELS</b> Towel, denim pants	Medium High	55
<b>NORMAL</b> Work clothes, corduroys	Medium	41
<b>DELICATES</b> Lingerie, sheets, blouses	Low	32

### 2. Manual Dry Cycles

Use Manual Cycles to select a specific amount of drying time and a drying temperature. When a Manual Cycle is selected, the ESTIMATED TIME REMAINING display shows the actual time remaining in your cycle. You can change the actual time in the cycle by pressing MORE TIME or LESS TIME.

#### Speed Dry

Use for small loads or loads that need a short drying time.

#### Air Dry

Use the Air Dry Modifier for items that require drying without heat such as rubber, plastic and heat-sensitive fabrics.

Manual Preset Cycle Settings		
Manual Dry Cycles Load Type	Temp.	Default Time* (Minutes)
<b>SPEED DRY</b> SMALL LOADS	High	25
<b>AIR DRY</b>	Air Dry	30

### 3 Custom Program Button

Set up your favorite combination of settings and save them here for one-touch recall.

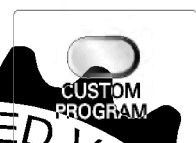

1. Select a cycle.
2. Change DRY LEVEL and TEMP. CONTROL.
3. Select OPTIONS you want.
4. Press and hold the CUSTOM PROGRAM.

To recall your stored CUSTOM PROGRAM Press CUSTOM PROGRAM button, then press START/PAUSE.



**4 Time Change Button**

- Press MORE TIME or LESS TIME until the desired drying time is set.

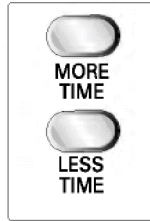

**Note**

Time change button is available only with Manual Dry, Time Dry and Rack Dry programs.

**5 LED Display**



**1. CHECK FILTER REMINDER**

The display will show CHECK FILTER when the dryer is turned on as a reminder to check the filter. It turns off when the START/PAUSE button is pressed.

**⚠ WARNING!**

- For better drying performance and safety, clean lint filter every single use.
- Failure to follow these instructions can result in death or fire.

**2. Estimated Time Remaining**

The display shows the estimated time remaining. In addition to this, if the dryer has some problem, it displays error messages.

**3. CYCLE COMPLETION INDICATOR**

Shows how much of the current drying cycle has been completed.

**4. STATUS/CYCLE DISPLAY**

This portion of the display shows the selected cycle, operating status, and special messages. If a cycle has special instructions, they will also be displayed in this area.

**6 Option Buttons**

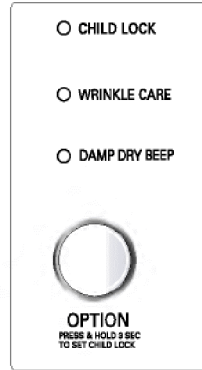

**1. Child Lock**

Child Lock can be used to prevent your children from changing options on control panel while the dryer is running.



When Child Lock is enabled, all the buttons will be locked and Child Lock glows.

To enable Child Lock, Press and hold OPTION for 3 seconds, A single beep tone is heard and Child Lock is displayed on the status window. To disable Child Lock, press and hold OPTION for 3 seconds again.

**2. Wrinkle Care**

This option helps to prevent wrinkles in your laundry.

When you select the wrinkle free option, the dryer will periodically tumble for up to three hours after the cycle has completed.

You can use this option in case you can not remove laundry immediately after drying is done.



**3. Damp Dry Beep**

When you select the damp dry beep option, a beep will alert you when your load is approximately 80% dry. This notice will allow you to remove lightweight items that are dry or other items that you may wish to iron.



**4. Rack Dry**

Rack Dry is designed for use with items which are not designed for tumble drying such as sweaters, silk or lingerie. Sneakers also will dry well with this option.

**■ To use the RACK DRY**

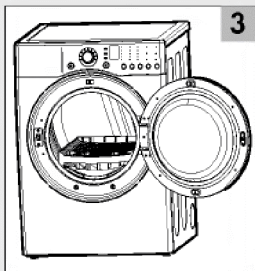
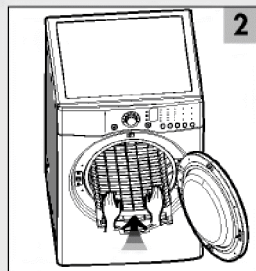
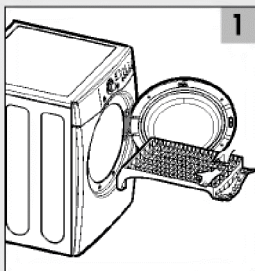

1. Open the door. Hold the dryer rack with both hands.
2. Put the dryer rack into the drum.
3. Make sure Dryer RACK is evenly spaced right onto the drum inside and door rim.

**Note**

Don't use the rack for normal tumble drying. The rack is shipped in place in your dryer so remove rack for normal laundry.

Suggested Items for Rack Drying	Temperature Setting	Suggested Time* (Minutes)
Washable wool items	Low	20
Stuffed toys with cotton or polyester fiber filling	Low/Ultra Low	20/30
Stuffed toys, foam rubber filled.	Air Dry/ Ultra Low	50/30
Foam rubber pillows	Air Dry	50
Athletic shoes	Air Dry	20

\* Reset time as needed to complete drying.

**7 Beeper**

The BEEPER controls the volume of the beep that is made when you press any of the buttons on the control panel. Press BEEPER to adjust the sound level or turn off the signal.

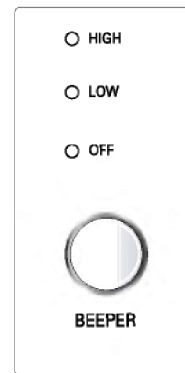

**8 Drying Time Control**

Use Time Dry Option to change Drying Time on your own. You can select the desired operation time manually by pressing Time Dry button between 20 to 60 minutes.

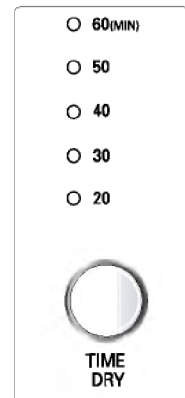

**9 Temp. Control**

Use Temp. Control Option to select temperatures for the Manual Cycles. Press TEMP CONTROL until the desired temperature setting glows. Temperature modifiers cannot be used with the Sensor Dry Cycles.



**When Using Air Dry**

This chart shows examples of items that can be dried using AIR DRY.

Type of Load	Default Time* (Minutes)
Foam rubber-pillows, padded bras, stuffed toys	20 - 30
Plastic shower curtains, tablecloths	20 - 30
Rubber-backed rugs	40 - 50
Olefin, polypropylene, shear nylon	10 - 20

Reset cycle to complete drying, if needed.

- Check to see that coverings are securely stitched.
- Shake and fluff pillows by hand periodically during the cycle.
- Dry item completely. Foam rubber pillows are slow to dry.

**NOTE:** Air Dry is not available with Sensor Dry Cycles.

**10 Dryness Intensity Control**

- Use these buttons to set dry level
- First, select sensor dry cycle.
- Select dry level to adjust how much you want to dry the load. As the cycle runs, the control senses the dryness of the load and adjusts the time automatically based on the selected dryness level.

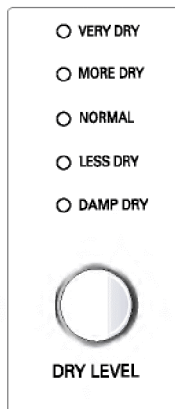

**Note**

DRY LEVEL selections can only be made while using Sensor Dry Cycles. Selecting MORE Dry or LESS Dry automatically adjusts the needed time which is already sensed.

**11 Start / Pause Button**

- Use this button for start or pause.

**Starting your dryer**

**1. Before use**

- Clean lint screen before or after each cycle.
- Place laundry into dryer and shut door. See Loading.
- Turn the knob to select the drying cycle you want. The preset setting for Sensor Dry Cycles or Manual Cycles will glow. The estimated or actual cycle time (in minutes) will show in the display.

**Following are sample loads for Super Capacity Dryers:**

<b>Heavy Work Clothes</b>	
4 jeans	2 sweatpants
4 workpants	2 sweatshirts
4 work shirts	
<b>Cotton/Towels</b>	
10 bath towels	14 wash cloths
10 hand towels	
<b>Mixed Load</b>	
3 sheets (1 king, 2 twin)	9 T-shirts
4 pillowcases	9 shorts
3 shirts	10 handkerchiefs
3 blouses	

**2. Loading**

- Determine load size by the amount of space the load requires rather than the weight of the load.
- Avoid overloading the dryer. Following these instructions can help reduce your utility bill, prolong the life of your clothes, and decrease the likelihood of uneven drying and wrinkle.

**3. To use a sensor dry cycle**

- Select DRY LEVEL to adjust how dry you want the load. As the cycle runs, the control senses the dryness of the load and adjusts the time automatically for the selected dryness level.
- Select the desired options.
- Press START/PAUSE

**Note**

DRY LEVEL selections can only be made while using Sensor Dry Cycles. Selecting MORE Dry or LESS Dry automatically adjusts the sensed time needed.



**4. To use a manual dry cycle**

- Select a Manual Dry Cycle.
- Press MORE TIME or LESS TIME until the desired drying time is displayed. Tap MORE TIME or LESS TIME and the time will change by 1 minute interval.

**Note**

The MORE TIME or LESS TIME feature can be used with Manual Dry, Time Dry and Rack Dry Cycles.

- Press TEMP. CONTROL until the desired temperature indicator glows.
- (OPTIONAL STEP) If desired, select OPTIONS. For more details, see Options.
- Press START/PAUSE. Be sure the door is closed.
- If you do not press START/PAUSE within 10 minutes of selecting the cycle, the dryer automatically shuts off.
- If you wish to end your drying cycle after pressing START/PAUSE, press START/PAUSE again.

**To stop your dryer at any time**

Press START/PAUSE or open the door.

**5. Pausing or restarting**

- To pause the dryer at any time:  
Open the door or press START/PAUSE.
- To restart the dryer  
Close the door. Press START/PAUSE.

**Note**

Drying will continue from where the cycle was interrupted if you close the door and press START within 10 minutes. If the cycle is interrupted for more than 10 minutes, the dryer will shut off. Select new cycle settings before restarting the dryer.

**Maintenance****Clean lint filter**

Clean the lint filter after each use and check it before use. Not cleaning or emptying the filter will increase drying time and energy consumption, therefore dryer life expectancy could be shortened after all.

**■ Clean the door and its opening**

1. Wipe out the door opening. Otherwise, build-ups of dirty and foreign objects will damage sealing of door.

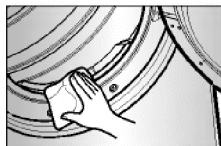

2. Clean the transparent glass door to keep inside view clear through the glass.

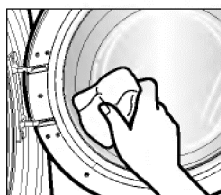

1. Open the door and pull the filter straight up.

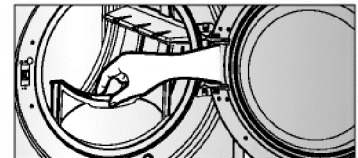

2. Clean the filter using one of the following methods.

- ① Run the fingers across the filter.



- ② Vacuum the lint filter.

- ③ Wash the lint screen in warm soapy water. Dry thoroughly and replace.



**Troubleshooting Tips**

Save time and money! Review the charts on the following pages first and you may not need to call for service.

**1. Problem: My Dryer Won't Start**

Question	What to Do
• Is the dryer plugged in?	Confirm that the dryer's plug is securely and completely pushed into the laundry room's power outlet.
• Is the fuse blown, or is the circuit breaker tripped?	Check your home's or laundry room's fuse box/circuit breaker box and replace the fuse or reset the circuit breaker. (IMPORTANT: electric dryers generally use two fuses or breakers.)

**2. Problem: My Dryer Doesn't Heat**

Question	What to Do
• Is the fuse blown, or is the circuit breaker tripped?	If the fuse is blown or the circuit breaker tripped, the dryer might tumble but not heat. Check your home's or laundry room's fuse box/circuit breaker box and replace the fuse or reset the circuit breaker. (IMPORTANT: electric dryers generally use two fuses or breakers.)
• Is the gas supply or service blocked or off?	Confirm that the house gas shutoff and the dryer gas shutoff are both fully open.

**3. Problem: There Are Greasy Spots On My Clothes.**

Question	What to Do
• Did you follow the instructions on your fabric softener product?	Confirm and follow the instructions provided with your fabric softener product.
• Are you drying clean and dirty clothes together?	Make sure to use your dryer to dry only clean items, because dirty items can soil clean clothes placed in the same load or later placed in the dryer drum.
• Were your clothes entirely clean?	Stains on dried clothes are actually stains that weren't cleansed during the washing process. Please review and confirm that you are following your washing instructions and that the clothes are being completely cleaned.

**4. Problem: My Dryer Displayed An Error Code.**

Question	What to Do
tE1	It is displayed when thermistor is open. In this case, the thermistor should be replaced and call a service center.
tE2	It is displayed when thermistor is shorted. In this case, the thermistor should be replaced by a service center.



**5. Problem: There Is Lint On My Clothes**

Question	What to Do
• Is your lint filter full?	Please refer to the manual section on cleaning the lint filter, and please confirm that the lint filter is clean. It is important that the lint filter is clean before each new load of laundry.
• Did you properly sort your load of laundry?	In order to reduce the amount of lint in a load of laundry, sort lint producers (like a fuzzy white cotton towel) separately from clothes that might catch lint (such as a pair of black linen pants).
• Do your clothes have excess static electricity?	See comments below under. There Is Static In My Clothes After Drying.
• Did you overload your dryer?	Divide your larger load into smaller loads.
• Did you place any paper, tissue, or other similar material in the load?	Sometimes a person might forget to take a piece of paper or a tissue out of a pocket, and this paper, tissue, or similar material can cause excess lint in a load of laundry. Confirm that the pockets of pants, shirts, and other articles of clothing are empty before washing and drying.

**6. Problem: There Is Static In My Clothes After Drying**

Question	What to Do
• Did you use fabric softener?	Try using a fabric softener to reduce static electricity.
• Did you over dry the load of laundry?	Over-drying a load of laundry can cause a build up of static electricity. Try using a fabric softener or adjust your settings and use a shorter drying time.
• Are you drying synthetic, permanent press and blends?	These materials can cause static to build up in a load of dried clothes. Try using a fabric softener.

**7. Problem: The Drying Time Is Not Consistent**

Question	What to Do
• Are you using consistent heat settings and consistent load sizes?	The drying time for a load will vary depending on the heat setting, the type of heat used (electric, natural or LP gas), the size of the load, the type of fabrics, the wetness of the clothes and the condition of the exhaust ducts and lint filter.

**8. Problem: Water Is Found Around The Cabinet Cover When Opening The Door.**

Question	What to Do
• Is water found around cabinet cover when opening the door?	It is not out of order because this is condensed moisture by drying.



**9. Problem: It Takes Too Long For My Clothes To Dry**

Question	What to Do
• Did you properly sort your loads of laundry?	Separate heavy weight items from light weight items when creating loads.
• Are you drying large loads of heavy fabrics?	Heavy fabrics take longer to dry because they tend to retain more moisture. To help reduce and maintain more consistent drying times for large and heavy fabrics, separate these items into smaller loads of a consistent size.
• Are the dryer controls properly set?	Use the appropriate control settings for the type of load you are drying.
• Is the lint filter clean before each new load of laundry?	Please confirm that the lint filter is clean prior to each new load of laundry.
• Are the exhaust ducts clear and properly configured?	Confirm through review of the appropriate sections of this manual that the exhaust venting ductwork is properly configured. Confirm that the venting is free of obstructions. Confirm that the outside wall dampers are moving freely, that the dampers are not pushed in, and that nothing has been set against the dampers.
• Is the fuse blown, or is the circuit breaker tripped?	Check your home's or laundry room's fuse box/circuit breaker box and replace the fuse or reset the circuit breaker. (IMPORTANT: electric dryers generally use two fuses or breakers.)
• Did you overload your dryer?	Divide your larger load into a number of smaller loads.
• Did you under load your dryer?	If you are only drying a handful of items, add a few extra pieces to help ensure proper tumbling action.

**10. Problem: My Clothes Are Wrinkled**

Question	What to Do
• Are you over drying your laundry?	Over drying a load of laundry can lead to wrinkled clothes. Try a shorter drying time, and remove items while they still retain a slight amount of moisture.
• Are you removing your laundry from the dryer soon after the drying cycle is complete?	Remove your laundry from the dryer after the drying cycle ends and either hang or fold the items.

**11. Problem: My clothes are shrinking**

Question	What to Do
• Are you following the care instructions for your garment?	To avoid shrinkage, please carefully follow the care and use instructions for your garment, because some fabrics will naturally shrink when washed. Other fabrics can be washed but will shrink when dried in a dryer.

**12. Problem: RLM (Remote Laundry Monitor)**

Question	What to Do
• RLM problem	See the Owner's Manual of RLM & PLC module.





## Free Manuals Download Website

<http://myh66.com>

<http://usermanuals.us>

<http://www.somanuals.com>

<http://www.4manuals.cc>

<http://www.manual-lib.com>

<http://www.404manual.com>

<http://www.luxmanual.com>

<http://aubethermostatmanual.com>

Golf course search by state

<http://golfingnear.com>

Email search by domain

<http://emailbydomain.com>

Auto manuals search

<http://auto.somanuals.com>

TV manuals search

<http://tv.somanuals.com>