



Website:<http://biz.LGservice.com>  
E-mail:<http://www.LGService.com/techsup.html>

# COLOR MONITOR SERVICE MANUAL

CHASSIS NO. : CA-119

FACTORY MODEL: CB773H

**MODEL: StudioWorks 773N (CB773H-ML),  
StudioWorks 773E (CB773H-EL),  
(CB773H-NJ), (CB773H-EJ), TINY773N (773N Rev B)**

\*( ) ID LABEL Model No.

## CAUTION

BEFORE SERVICING THE UNIT,  
READ THE **SAFETY PRECAUTIONS** IN THIS MANUAL.



# CONTENTS

SPECIFICATIONS .....	2	DESCRIPTION OF BLOCK DIAGRAM.....	9
SAFETY PRECAUTIONS .....	3	ADJUSTMENT .....	10
TIMING CHART .....	4	TROUBLESHOOTING GUIDE .....	12
OPERATING INSTRUCTIONS .....	5	EXPLODED VIEW.....	22
WIRING DIAGRAM .....	6	REPLACEMENT PARTS LIST .....	24
DISASSEMBLY .....	7	PIN CONFIGURATION.....	29
BLOCK DIAGRAM .....	8	SCHEMATIC DIAGRAM.....	34
		PRINTED CIRCUIT BOARD.....	36

## SPECIFICATIONS

### 1. PICTURE TUBE

Size	: 17 inch
Deflection Angle	: 90°
Neck Diameter	: 29.1 mm
Dot Pitch	: 0.27 mm
Face Treatment	: W-ARASC (Anti-Reflection and Anti-Static Coating)
Low Radiation	: MPR II, TCO 99

### 2. SIGNAL

- 2-1. Horizontal & Vertical Sync
- 1) Input Voltage Level: Low=0~1.2V, High=2.5~5.5V
  - 2) Sync Polarity : Positive or Negative
- 2-2. Video Input Signal
- 1) Voltage Level : 0 ~ 0.7 Vp-p
    - a) Color 0, 0 : 0 Vp-p
    - b) Color 7, 0 : 0.467 Vp-p
    - c) Color 15, 0 : 0.7 Vp-p
  - 2) Input Impedance : 75 Ω
  - 3) Video Color : R, G, B Analog
  - 4) Signal Format : Refer to the Timing Chart

- 2-3. Signal Connector
- 3 row 15-pin Connector (Attached)

- 2-4. Scanning Frequency
- |            |               |
|------------|---------------|
| Horizontal | : 30 ~ 71 kHz |
| Vertical   | : 50 ~ 160 Hz |

### 3. POWER SUPPLY

- 3-1. Power Range
- AC 100~220V, 60Hz, 2.0A Max.

### 3-2. Power Consumption

MODE	POWER CONSUMPTION	LED COLOR
MAX	85 W	GREEN
NORMAL (ON)	73 W	GREEN
STAND-BY	less than 15 W	AMBER
SUSPEND	less than 15 W	
OFF	less than 5 W	AMBER

### 4. DISPLAY AREA

- 4-1. Active Video Area :
- Max Image Size - 326.7 x 245.5 mm (12.86" x 9.67")
  - Preset Image Size - 310 x 230 mm (12.20" x 9.06")
- 4-2. Display Color : Full Colors
- 4-3. Display Resolution : 1280 x 1024 / 60Hz(Max)  
(Non-Interlace)
- 4-4. Video Bandwidth : 110 MHz

### 5. ENVIRONMENT

- 5-1. Operating Temperature: 0°C ~ 40°C  
(Ambient)
- 5-2. Relative Humidity : 10%~ 90%  
(Non-condensing)
- 5-3. Altitude : 5,000 m

### 6. DIMENSIONS (with TILT/SWIVEL)

Width	: 400.0 mm (15.74 inch)
Depth	: 430.0 mm (16.92 inch)
Height	: 410.0 mm (16.14 inch)

### 7. WEIGHT (with TILT/SWIVEL)

Net Weight	: 14.4 kg (31.75 lbs.)
Gross Weight	: 16.6 kg (36.60 lbs.)

# SAFETY PRECAUTIONS

## SAFETY-RELATED COMPONENT WARNING!

There are special components used in this color monitor which are important for safety. **These parts are marked  on the schematic diagram and the replacement parts list.** It is essential that these critical parts should be replaced with the manufacturer's specified parts to prevent X-radiation, shock, fire, or other hazards. Do not modify the original design without obtaining written permission from manufacturer or you will void the original parts and labor guarantee.

**CAUTION:** No modification of any circuit should be attempted.

Service work should be performed only after you are thoroughly familiar with all of the following safety checks and servicing guidelines.

## SAFETY CHECK

Care should be taken while servicing this color monitor because of the high voltage used in the deflection circuits. These voltages are exposed in such areas as the associated flyback and yoke circuits.

## FIRE & SHOCK HAZARD

An isolation transformer must be inserted between the color monitor and AC power line before servicing the chassis.

- In servicing, attention must be paid to the original lead dress specially in the high voltage circuit. If a short circuit is found, replace all parts which have been overheated as a result of the short circuit.
- All the protective devices must be reinstalled per the original design.
- Soldering must be inspected for the cold solder joints, frayed leads, damaged insulation, solder splashes, or the sharp points. Be sure to remove all foreign materials.

## IMPLOSION PROTECTION

All used display tubes are equipped with an integral implosion protection system, but care should be taken to avoid damage and scratching during installation. Use only same type display tubes.

## X-RADIATION

The only potential source of X-radiation is the picture tube. However, when the high voltage circuitry is operating properly there is no possibility of an X-radiation problem. The basic precaution which must be exercised is keep the high voltage at the factory recommended level; the normal high voltage is about 25.5kV. The following steps describe how to measure the high voltage and how to prevent X-radiation.

**Note :** It is important to use an accurate high voltage meter calibrated periodically.

- To measure the high voltage, use a high impedance high voltage meter, connect (-) to chassis and (+) to the CDT anode cap.
- Set the brightness control to maximum point at full white pattern.
- Measure the high voltage. The high voltage meter should be indicated at the factory recommended level.
- If the meter indication exceeds the maximum level, immediate service is required to prevent the possibility of premature component failure.
- To prevent X-radiation possibility, it is essential to use the specified picture tube.

### CAUTION:

Please use only a plastic screwdriver to protect yourself from shock hazard during service operation.

## TIMING CHART

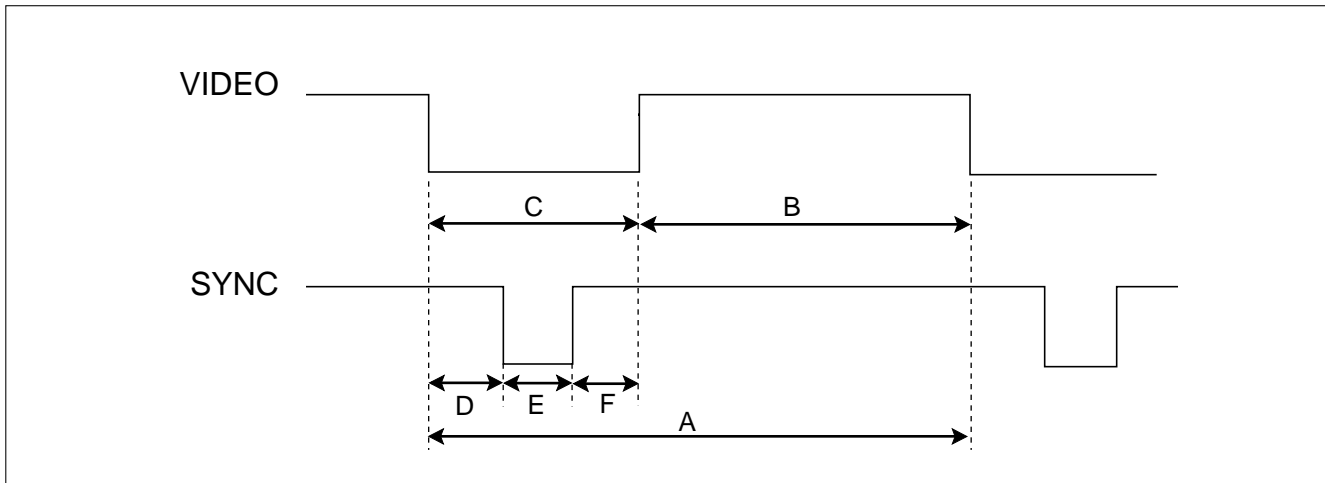

<< Dot Clock (MHz), Horizontal Frequency (kHz), Vertical Frequency (Hz), Horizontal etc... (μs), Vertical etc... (ms) >>

Mode	H/V Sort	Sync Polarity	Frequency	Total Period (A)	Video Active Time (B)	Blanking Time (C)	Sync Duration (E)	Back Porch (F)	Front Porch (D)	Resolution
1	H	-	37.50	26.67	20.32	6.35	2.03	3.81	0.51	640x480 75Hz
	V	-	74.99	13.335	12.802	0.533	0.080	0.427	0.026	
2	H	+	46.88	21.33	16.16	5.17	1.62	3.23	0.32	800x600 75Hz
	V	+	75.01	13.331	12.798	0.533	0.064	0.448	0.021	
3	H	+	53.68	18.63	14.22	4.41	1.14	2.70	0.57	800x600 85Hz
	V	+	85.07	11.755	11.178	0.577	0.056	0.503	0.018	
4	H	+	68.677	14.561	10.836	3.725	1.016	2.201	0.508	1024x768 85Hz
	V	+	85.00	11.764	11.182	0.582	0.044	0.524	0.014	

\* Mode 1~Mode 4: Basic Mode

# OPERATING INSTRUCTIONS

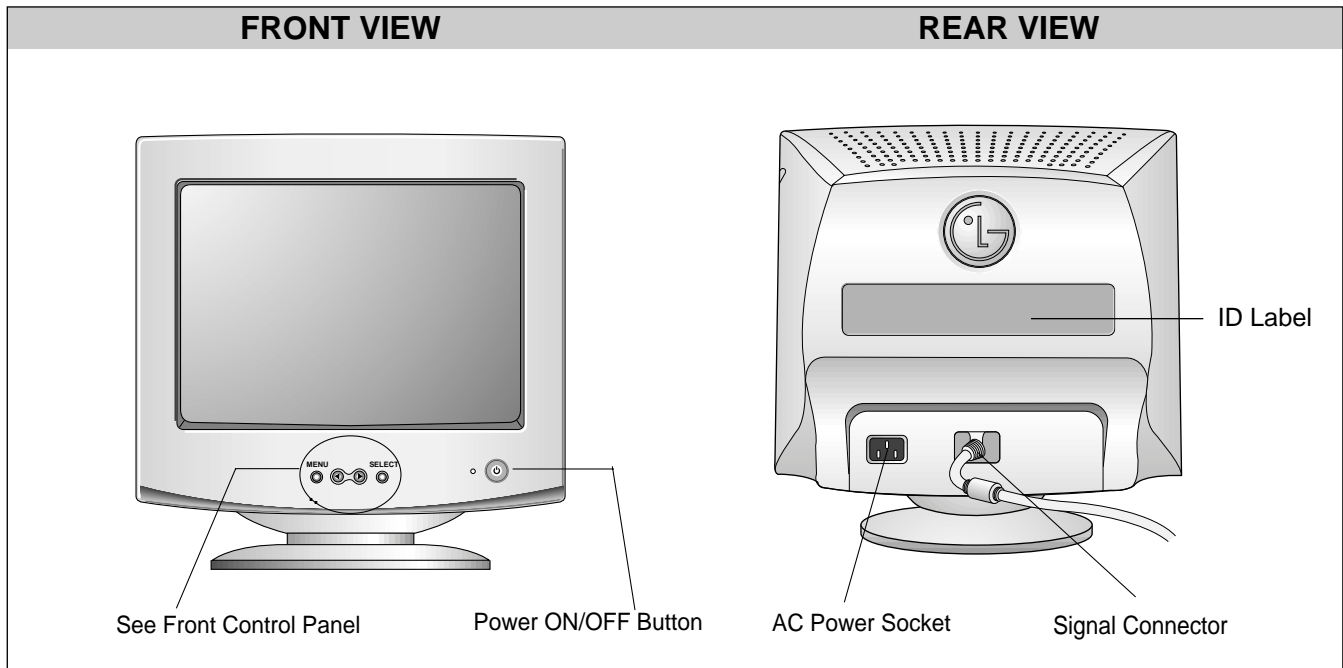

## Front Control Panel

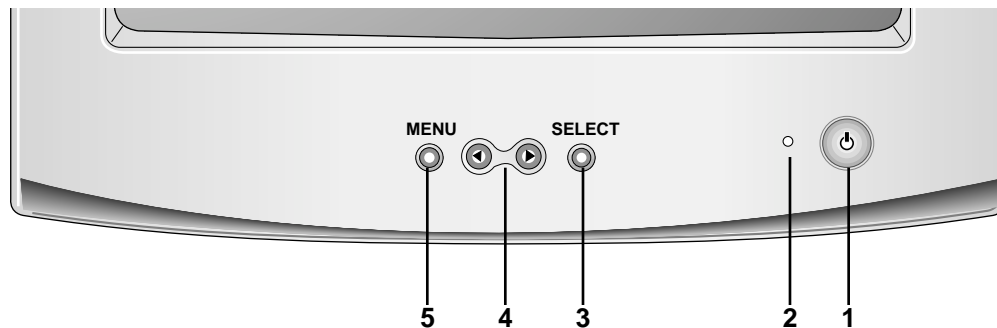

- 1. Power ON/OFF Button**  
Use this button to turn the monitor ON or OFF.
- 2. Power Indicator**  
This indicator lights up green when the monitor operates normally; in DPMS (Energy Saving) mode, -stand-by, suspend, or power off mode - its color changes to amber, and if abnormal or damaging circuit turns out amber blink.
- 3. Select Button**  
Use this button to enter a selection in the on screen display.
- 4. SET Button**  
Use these buttons to choose or adjust items in the on screen display.
- 5. MENU Button**  
Use this button to enter or exit the on screen display.

# WIRING DIAGRAM

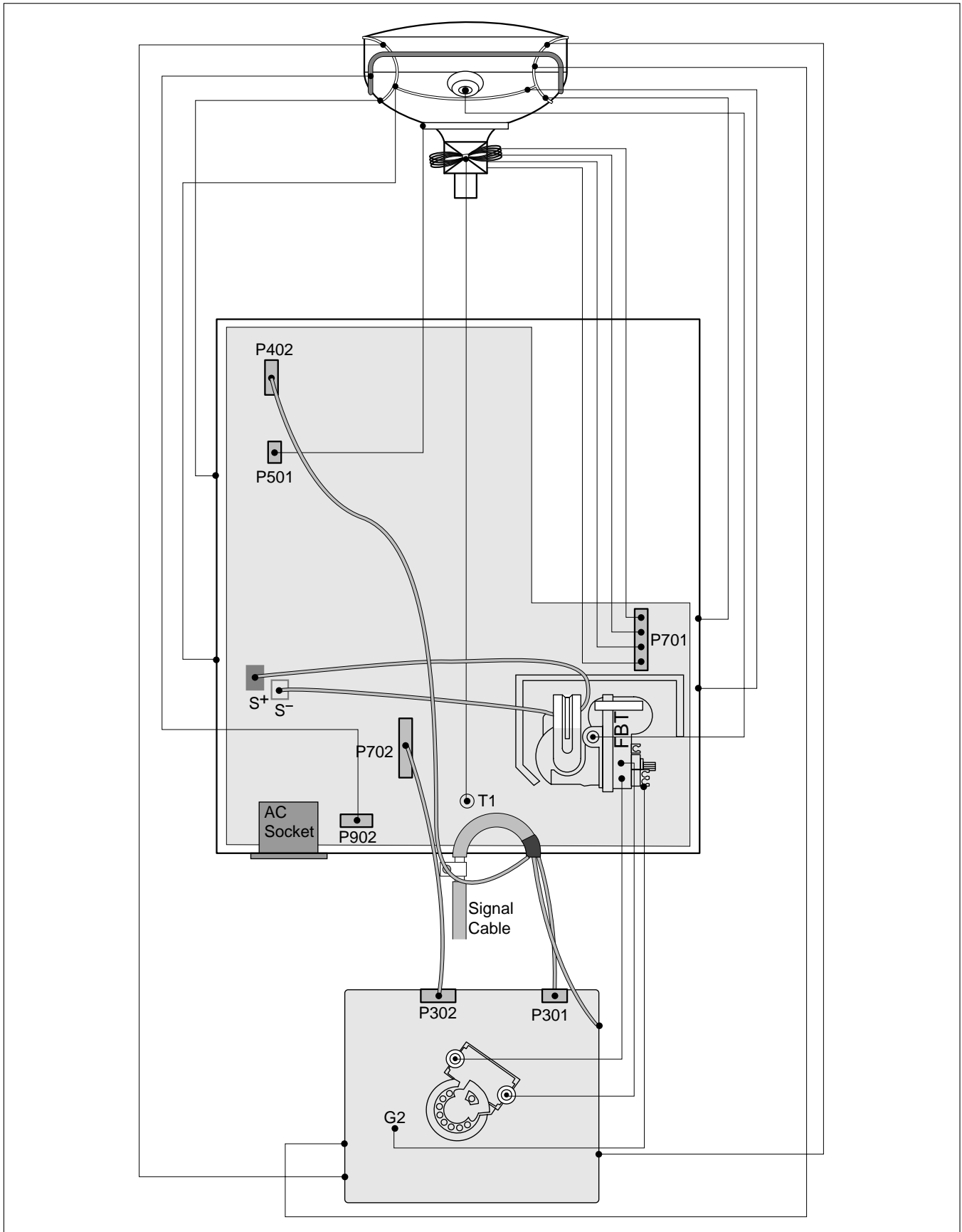

# BLOCK DIAGRAM

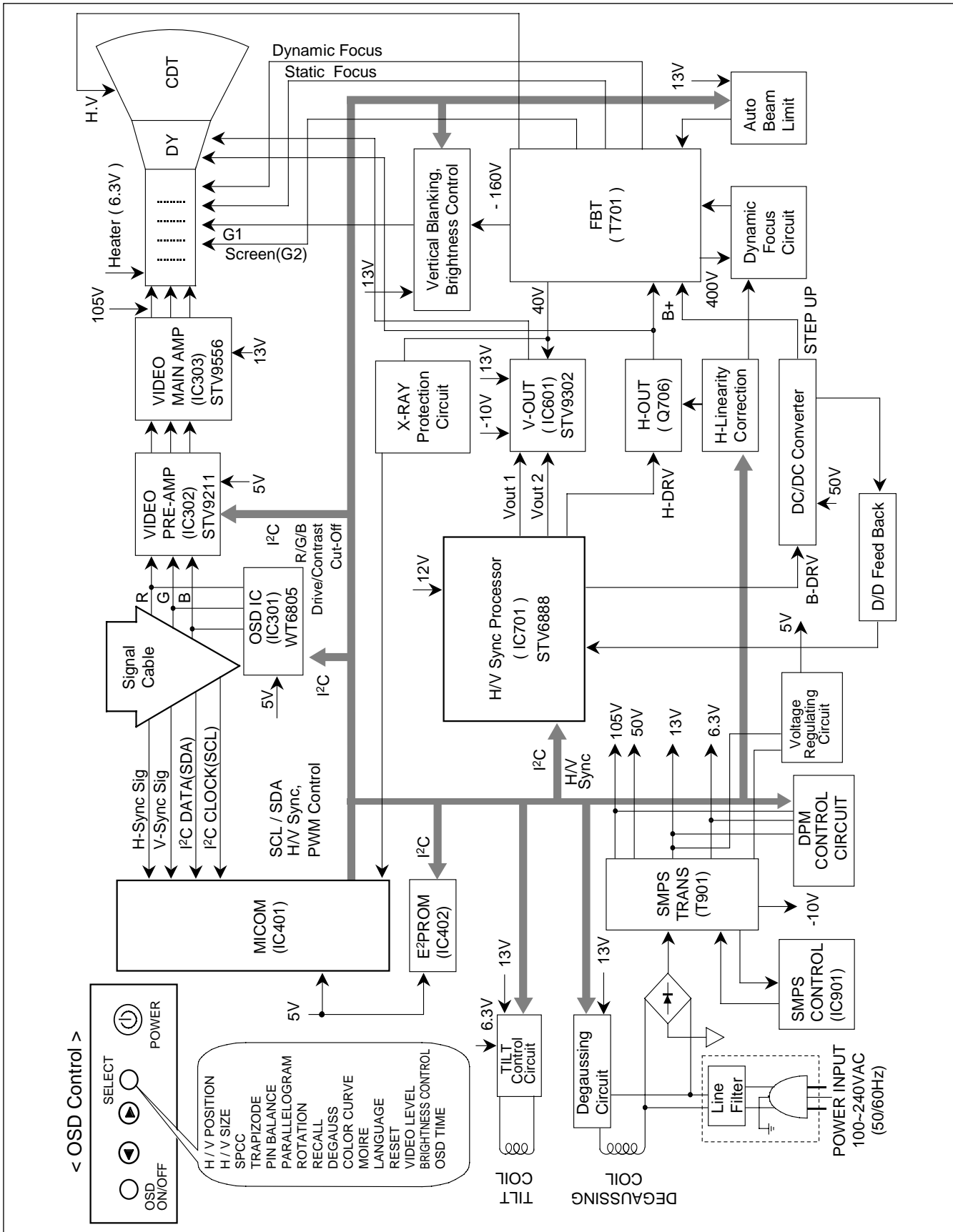

# DESCRIPTION OF BLOCK DIAGRAM

## 1. Line Filter & Associated Circuit.

This is used for suppressing noise of power input line flowing into the monitor and/or some noise generated in this monitor flowing out through the power input line.

That is to say, this circuit prevents interference between the monitor and other electric appliances.

## 2. Degauss Circuit & Coil.

The degauss circuit consists of the degaussing coil, the PTC(Positive Temperature Coefficient) thermistor(TH901), and the relay(RL901). This circuit eliminates abnormal color of the screen automatically by degaussing the shadow mask in the CRT during turning on the power switch. When you need to degauss in using the monitor, select DEGAUSS on the OSD menu.

## 3. SMPS(Switching Mode Power Supply).

This circuit is working of 90~264V AC(50/60Hz).

The operation procedure is as follows:

- 1) AC input voltage is rectified and smoothed by the bridge diodes (D900) and the capacitor (C908).
- 2) The rectified voltage(DC) is applied to the primary coil of the transformer(T901).
- 3) The control IC(IC901) generates switching pulse to turn on and off the primary coil of the transformer (T901) repeatedly.
- 4) Depending on turn ratio of the transformer, the secondary voltages appear at the secondary coils of the transformer(T901).
- 5) These secondary voltages are rectified by each diode(D941, D942, D951, D961, D971) and operate other circuit. (horizontal and vertical deflection, video amplifier, ...etc.)

## 4. X-ray Protection.

If the high voltage of the FBT reaches up to 29kV (abnormal state), IC401(MICOM) pin 35 Sensing from FBT directly.

Then MICOM control IC701 (Deflection controller) to stop Horizontal drive pulse and stop Horizontal Deflection.

## 5. Micom(Microprocessor) Circuit.

The operating procedure of Micom(Microprocessor) and its associated circuit is as follows:

- 1) H and V sync signal is supplied from the signal cable.
- 2) The Micom(IC401) distinguishes polarity and frequency of H and V sync.
- 3) The Micom sets operating mode and offers the controlled data. (H-size, H-position, V-size, ... etc.)
- 4) The controlled data of each mode is stored in itself.
- 5) User can adjust screen condition by each OSD function. The data of the adjusted condition is stored in EEPROM(IC402).

## 6. Horizontal and Vertical Oscillation.

This circuit generates the horizontal pulse and the vertical pulse by taking the H and V sync signal.

This circuit consists of the STV9302(IC601) and the associated circuit.

## 7. D/D(DC to DC) Converter.

This circuit supplies DC voltage to the horizontal deflection output circuit by increasing DC 50V which is the secondary voltage of the SMPS in accordance with the input horizontal sync signal.

## 8. Side-Pincushion & Trapezoid Correction Circuit.

This circuit improves the side-pincushion and the trapezoid distortion of the screen by mixing parabola and saw-tooth wave to output of the horizontal deflection D/D converter which is used for the supply voltage(B + ) of the deflection circuit.

## 9. Horizontal Deflection Output Circuit.

This circuit makes the horizontal deflection by supplying the saw-tooth current to the horizontal deflection yoke.

## 10. High Voltage Output & FBT(Flyback Transformer).

The high voltage output circuit is used for generating pulse to the primary coil of the FBT(Flyback Transformer) secondary of the FBT and it is supplied to the anode, focus, and screen voltage of the CRT.

## 11. H-Linearity Correction Circuit.

This circuit corrects the horizontal linearity for each horizontal sync frequency.

## 12. Vertical Output Circuit.

This circuit takes the vertical ramp wave from the STV6888(IC701) and performs the vertical deflection by supplying the saw-tooth current to the vertical deflection yoke.

## 13. Dynamic Focus Output Circuit.

This circuit takes the horizontal and the vertical parabola waves from the STV6888(IC701) and amplifies it to maintain constant focus on center and corners in the screen.

## 14. H & V Blanking and Brightness Control.

Blanking circuit eliminates retrace line by supplying negative pulse to the G1 of the CRT. And Brightness circuit is used for control of the screen brightness by changing DC level of the G1.



**15. Image Rotation (Tilt) Circuit.**

This circuit corrects the tilt of the screen by supplying the image rotation signal to the tilt coil which is attached near the deflection yoke of the CRT.

**16. Video Pre-Amp Circuit.**

This circuit amplifies the analog video signal from 0-0.7V to 0-4V. It is operated by taking the clamp, R, G, B drive and contrast signal from the Micom(IC401).

**17. Video Output Amp Circuit.**

This circuit amplifies the video signal which comes from the video pre-amp circuit and amplified it to applied the CRT cathode.

# ADJUSTMENT

## GENERAL INFORMATION

All adjustment are thoroughly checked and corrected when the monitor leaves the factory, but sometimes several adjustments may be required.

Adjustment should be following procedure and after warming up for a minimum of 30 minutes.

- Alignment appliances and tools.
  - IBM compatible PC.
  - Programmable Signal Generator.  
(eg. VG-819 made by Astrodesign Co.)
  - EPROM or EEPROM with saved each mode data.
  - Alignment Adaptor and Software.
  - Digital Voltmeter.
  - White Balance Meter.
  - Luminance Meter.
  - High-voltage Meter.

## AUTOMATIC AND MANUAL DEGAUSSING

The degaussing coil is mounted around the CDT so that automatic degaussing when turn on the monitor. But a monitor is moved or faced in a different direction, become poor color purity cause of CDT magnetized, then press DEGAUSS on the OSD menu.

## ADJUSTMENT PROCEDURE & METHOD

- Install the cable for adjustment such as Figure 1 and run the alignment program on the DOS for IBM compatible PC.
- Set external Brightness and Contrast volume to max position.

### 1. Adjustment for B<sup>+</sup> Voltage.

- 1) Display cross hatch pattern at Mode 4.
- 2) Check C999 (+) voltage to  $50.5 \pm 0.5$ Vdc.

### 2. Adjustment for High-Voltage.

- 1) Display cross hatch pattern at Mode 4.
- 2) DIST.ADJ. → CTRL PWM → High Voltage Command.
- 3) Adjust High Voltage to  $25.5$ kV $\pm 0.1$  kVdc.
- 4) Press Enter Key.

### 3. Adjustment for Factory Mode (Preset Mode).

- 1) Display cross hatch pattern at Mode 1.
- 2) Run alignment program for CB773H on the IBM compatible PC.
- 3) EEPROM → ALL CLEAR → Y(Yes) command.  
**<Caution>** Do not run this procedure unless the EEPROM is changed. All data in EEPROM (mode data and color data) will be erased.
- 4) Power button of the monitor turn off → turn on.
- 5) COMMAND → PRESET START → Y(Yes) command.
- 6) DIST. ADJ. → CTRL PWM → TILT command.

- 7) Adjust tilt as arrow keys to be the best condition.
- 8) DIST. ADJ. → BALANCE command.
- 9) Adjust parallelogram as arrow keys to be the best condition.
- 10) Adjust balance of pin-balance as arrow keys to be the best condition.
- 11) DIST. ADJ. → FOS. ADJ command.
- 12) Adjust V-SIZE as arrow keys to  $230 \pm 2$ mm.
- 13) Adjust V-POSITION as arrow keys to center of the screen.
- 14) Adjust H-SIZE as arrow keys to  $310 \pm 2$ mm.
- 15) Adjust H-POSITION as arrow keys to center of the screen.
- 16) Adjust S-PCC (Side-Pincushion) as arrow keys to be the best condition.
- 17) Adjust TRAPEZOID as arrow keys to be the best condition.
- 18) Save of the Mode 1.
- 19) Display from Mode 2 to 4 and repeat above from number 12) to 19)
- 20) PRESET EXIT → Y (Yes) command.

## 4. Adjustment for White Balance and Luminance.

- 1) Set the White Balance Meter.
- 2) Press the DEGAUSS on the OSD menu for demagnetization of the CDT.
- 3) COLOR ADJ. → LUMINANCE command of the alignment program.
- 4) Set Brightness and Contrast to Max position.
- 5) Display color 0,0 pattern at Mode 4.
- 6) COLOR ADJ. → BIAS ADJ. → COLOR No. → 1 command of the alignment program.
- 7) Check whether green color or not at R-BIAS and G-BIAS to min position and B-BIAS to 205 position and Sub-Brightness to 205(CD) position. Adjust G2 (screen) command to  $0.4 \pm 0.05$ FL of the raster luminance.
- 8) Adjust R-BIAS and G-BIAS command to  $x=0.283 \pm 0.005$  and  $y=0.298 \pm 0.005$  on the White Balance Meter with PC arrow keys.
- 9) Adjust SUB-Brightness command to  $0.4 \pm 0.1$ FL of the raster luminance.
- 10) Adjust repeat number 8).
- 11) After push the "ENTER" key.
- 11-1) COMMAND → PRESET START → Y(Yes) command.
- 12) Display color 15,0 full white pattern at Mode 4.
- 13) DRIVE ADJ. → No 1. command.

- 14) Set Brightness and Contrast to Max position.
- 15) Set SUB-CONTRAST 200(C8) (decimal) position.
- 16) Set B-DRIVE to 150(96) at DRIVE of the alignment program.
- 17-1) Adjust R-DRIVE and G-DRIVE command to white balance  $x=0.283\pm0.003$  and  $y=0.298\pm0.003$  on the White Balance Meter with PC arrow keys.
- 17-2) Display color 15,0 window pattern (70x70mm) at mode 4.
- 18) Adjust SUB-CONTRAST command to  $50\pm2FL$  .
- 19) After push the "ENTER" key.
- 20) Display color 15,0 full white patten at Mode 4..
- 21) COLOR ADJ. → LUMINANCE → ABL command.
- 22) Adjust ABL to  $32\pm1FL$  of the luminance.
- 23) After push the "ENTER" key, and "COMMAND → PRESET EXIT → Y(Yes)" command.
- 24) Exit from the program.

#### **5. Input EDID Data.**

- 1) Display color 15,0 cross hatch pattern at Mode 4.
- 2) EEPROM → Write EDID command and confirm "EDID Write OK!!" message of monitor.
- 3) Exit from the alignment program.
- 4) Power switch OFF/ON for EDID data save.

#### **6. Adjustment for Focus.**

- 1) Set the Brightness and Contrast to max position.
- 2) Display H character in full screen at Mode 4.
- 3) Adjust two Focus control on the FBT that focus should be the best condition.

# TROUBLESHOOTING GUIDE

## 1. NO POWER

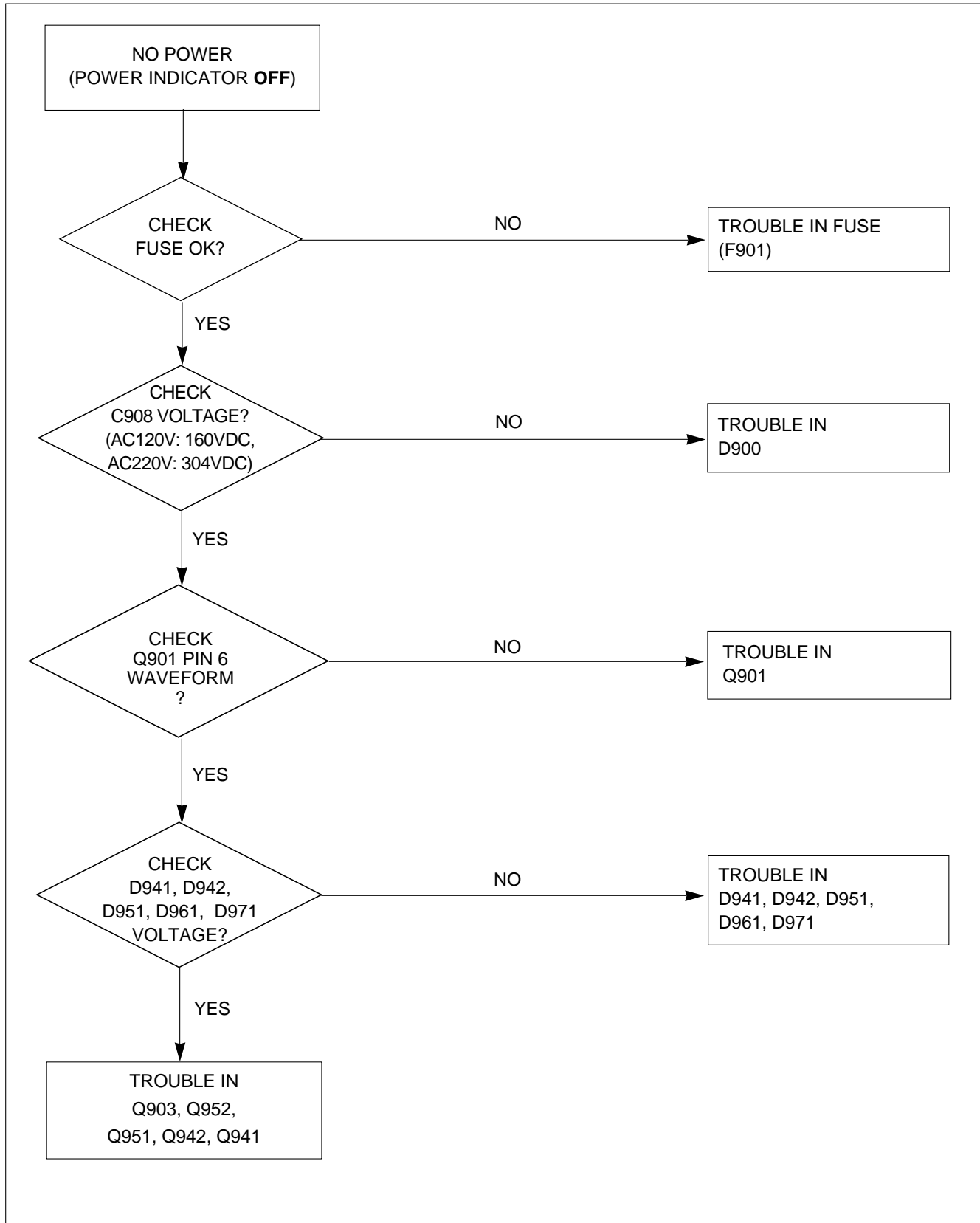

## 2. NO CHARACTER

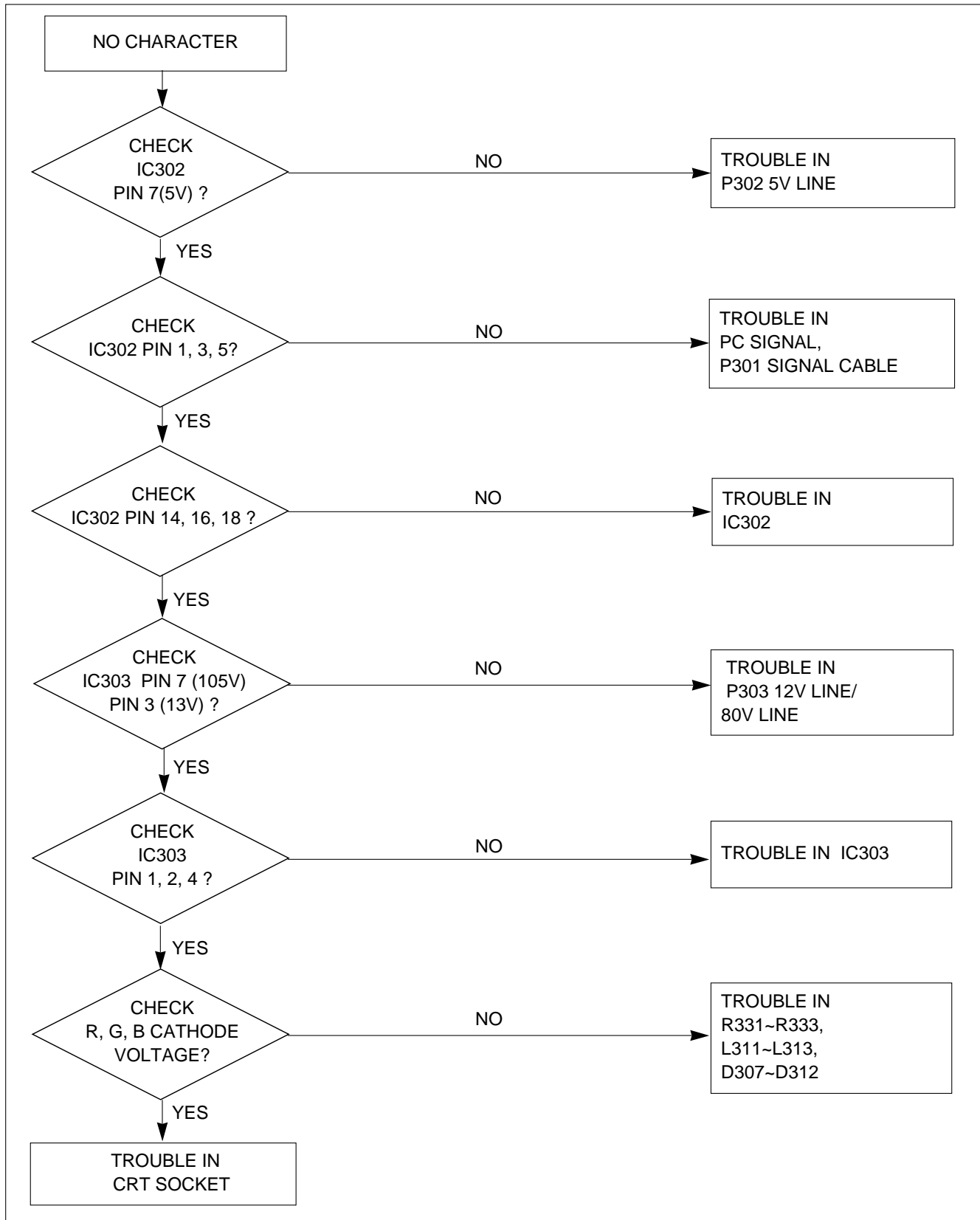

### 3. NO RASTER

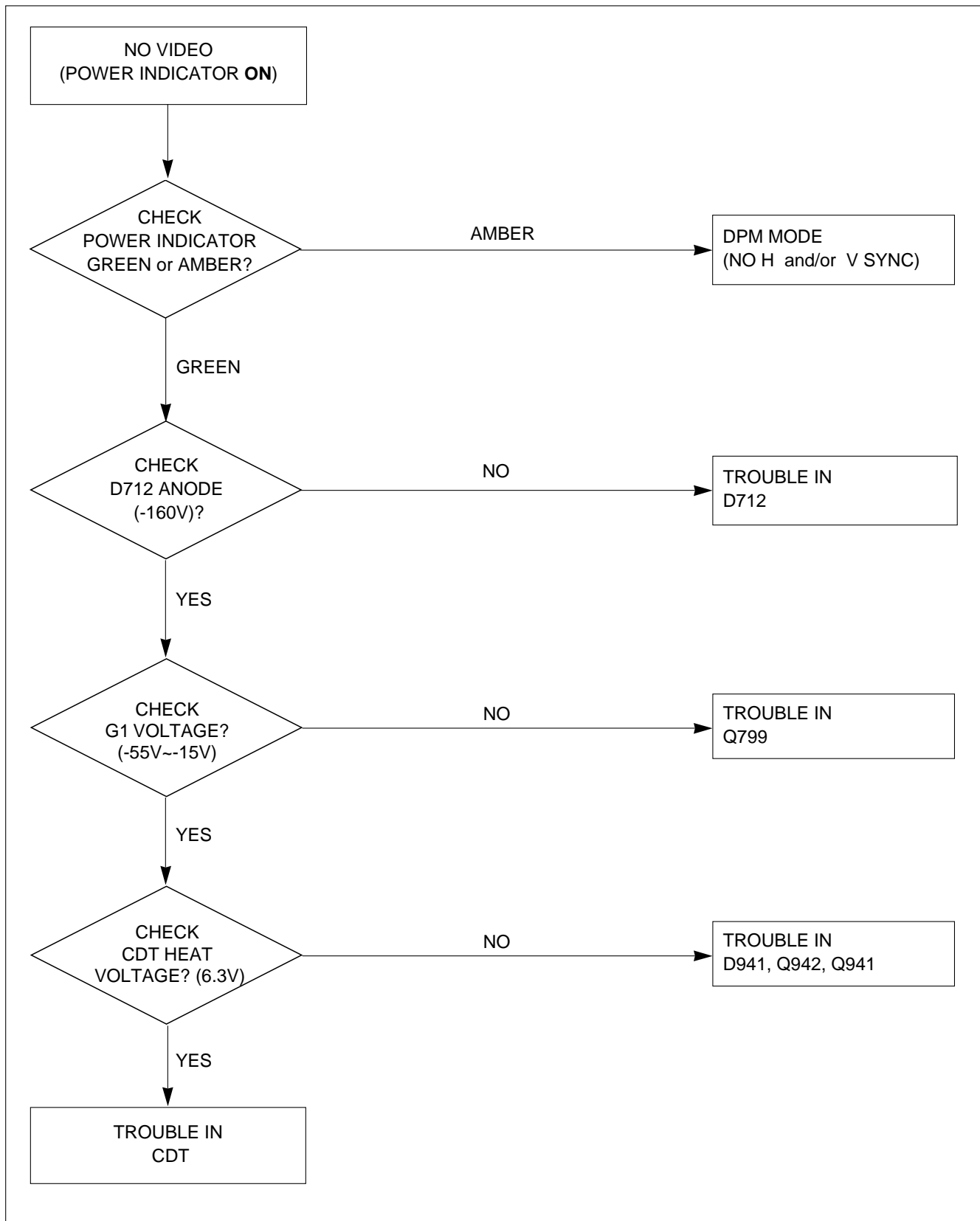

## 4. NO HORIZONTAL DEFLECTION

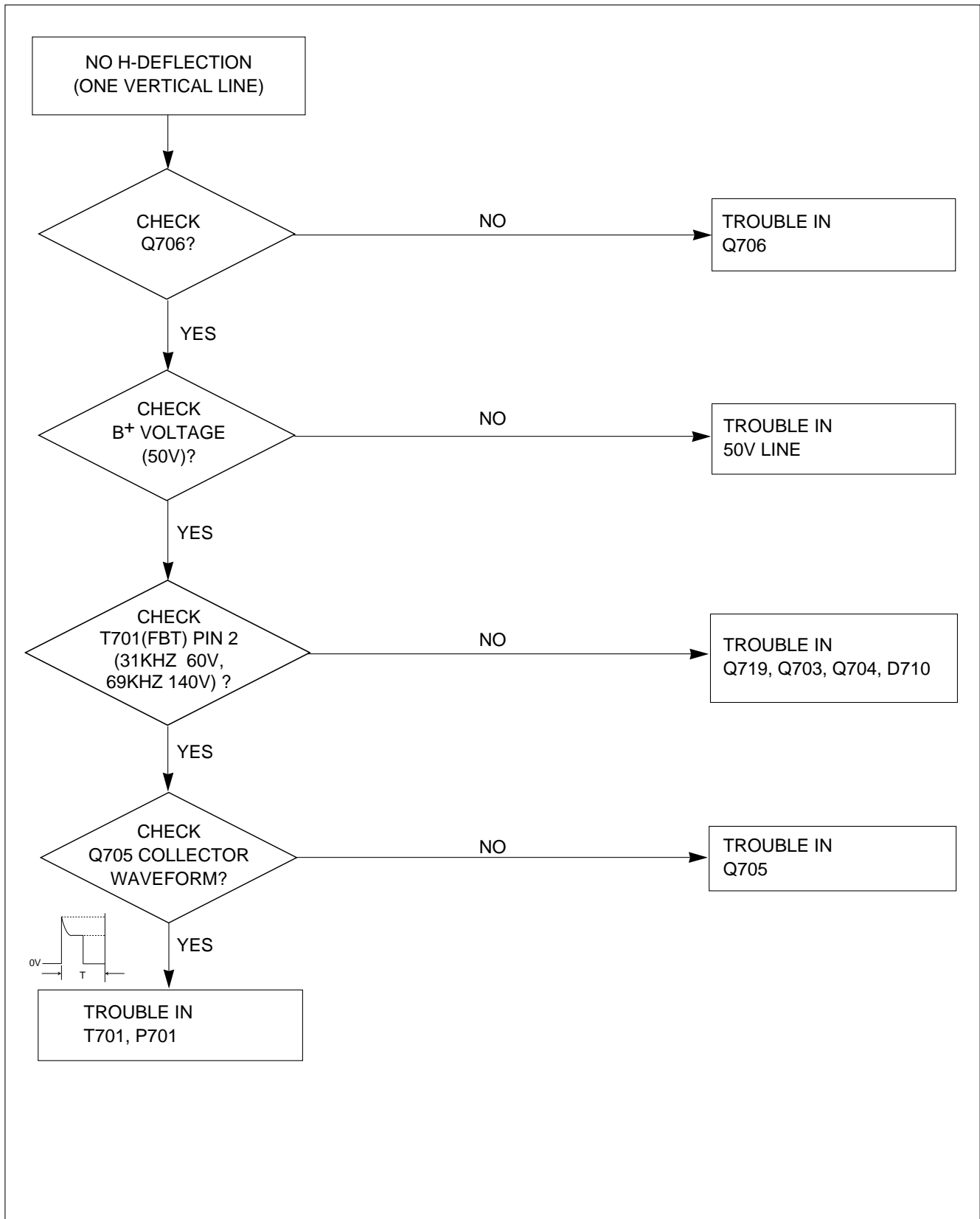

## 5. TROUBLE IN H-LINEARITY

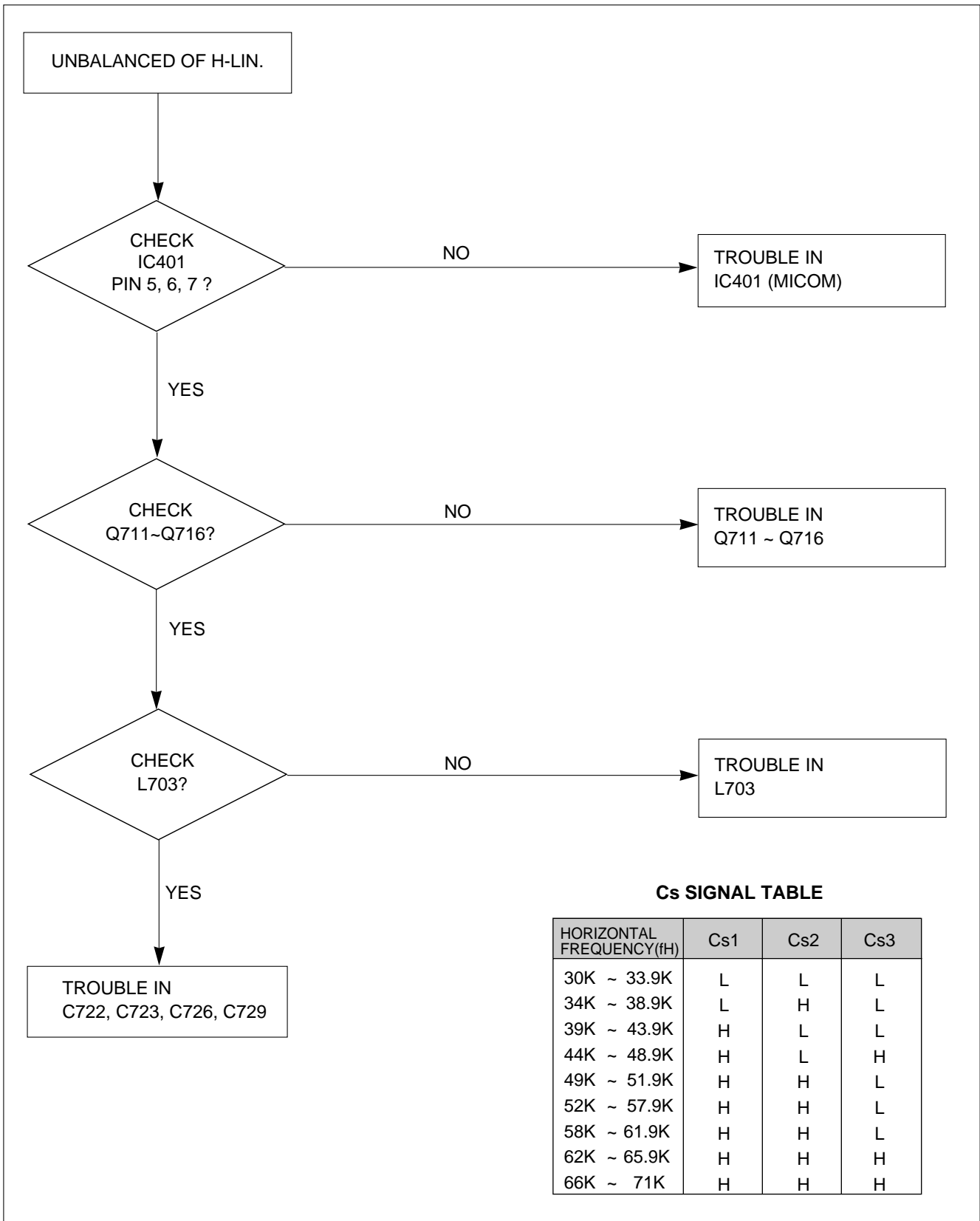



## 6. NO VERTICAL DEFLECTION

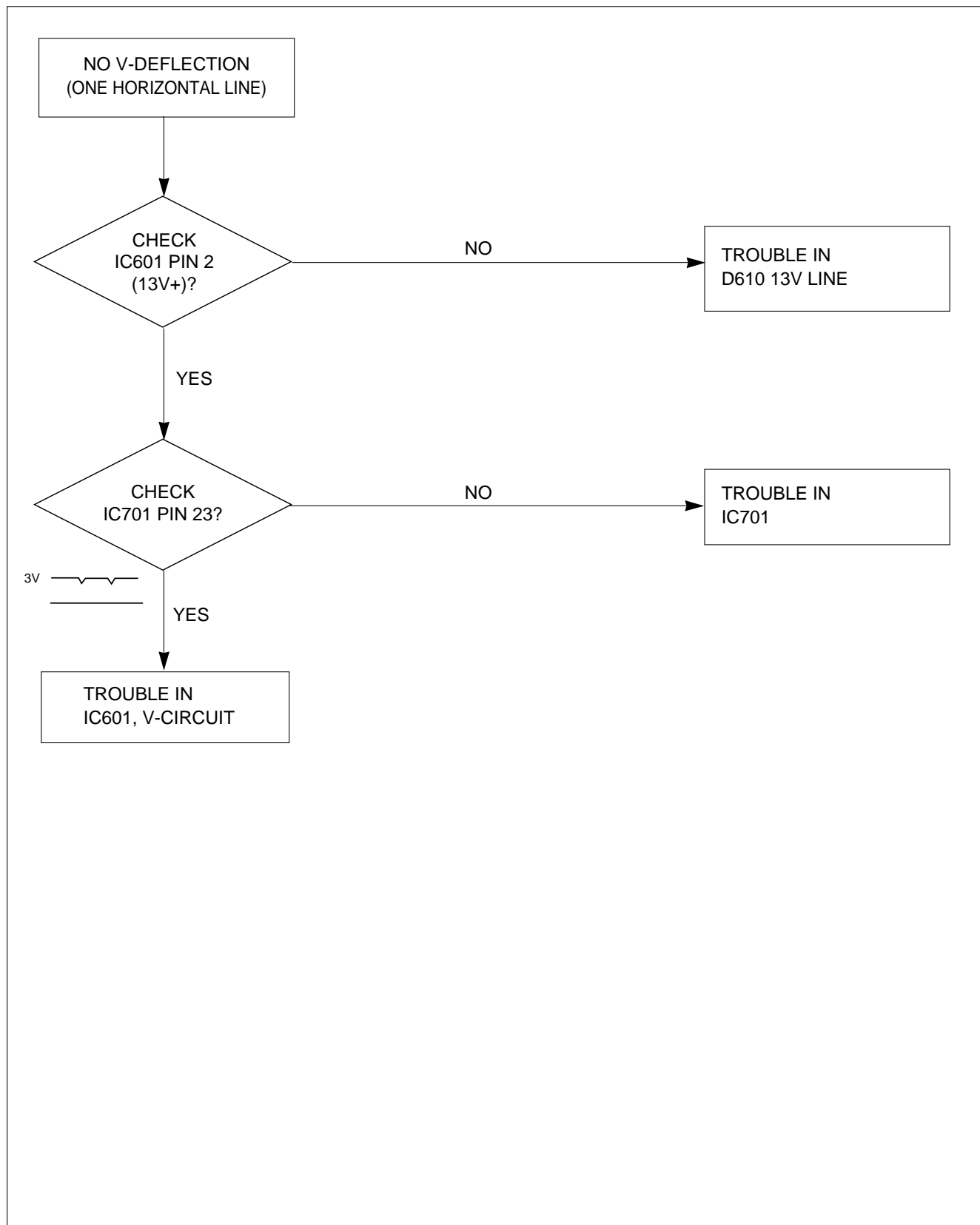

## 7. TROUBLE IN OSD

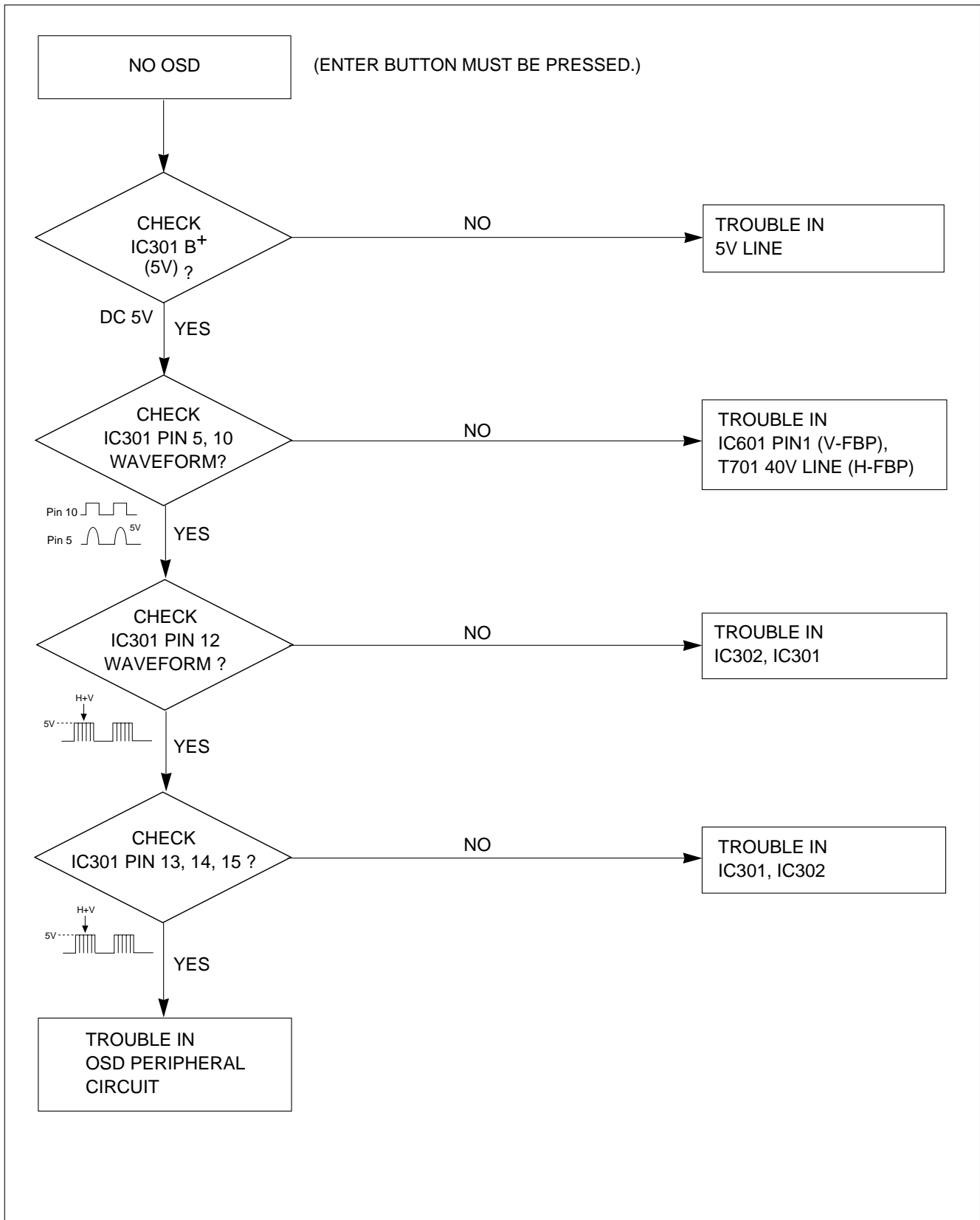

## 8. TROUBLE IN DPM

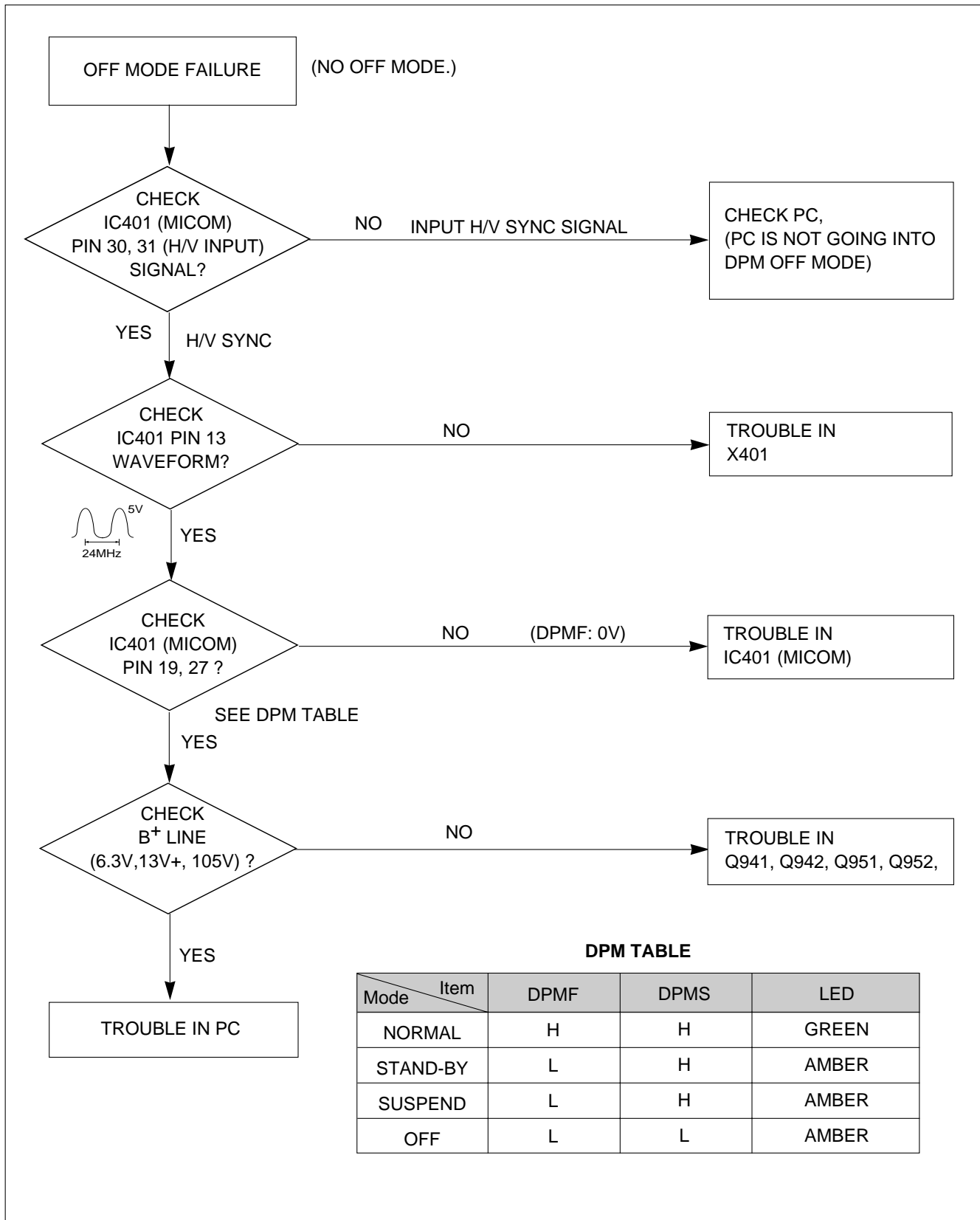

## 9. NO DEGAUSSING

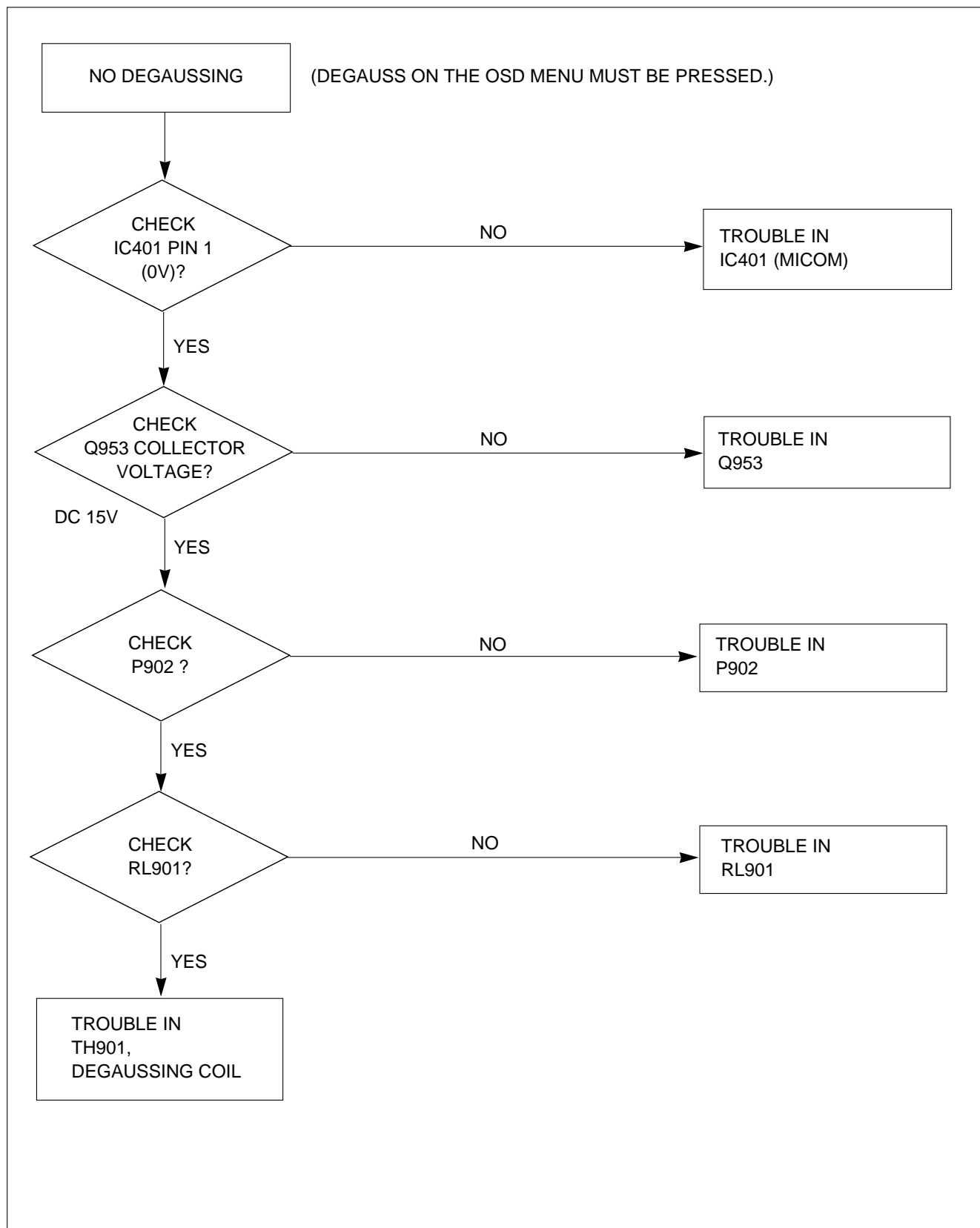

## 10. NO TILT (NO ROTATION)

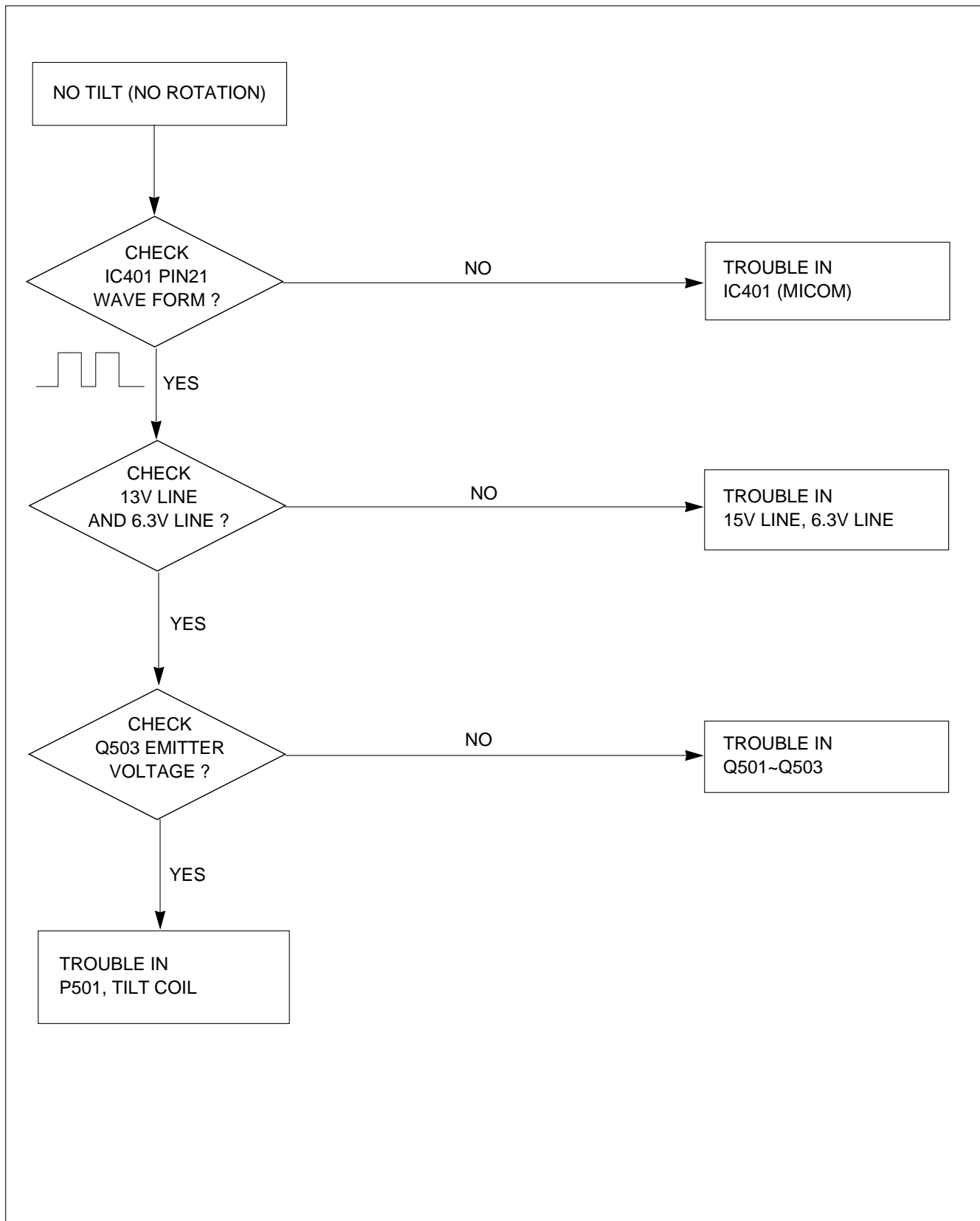

# EXPLODED VIEW

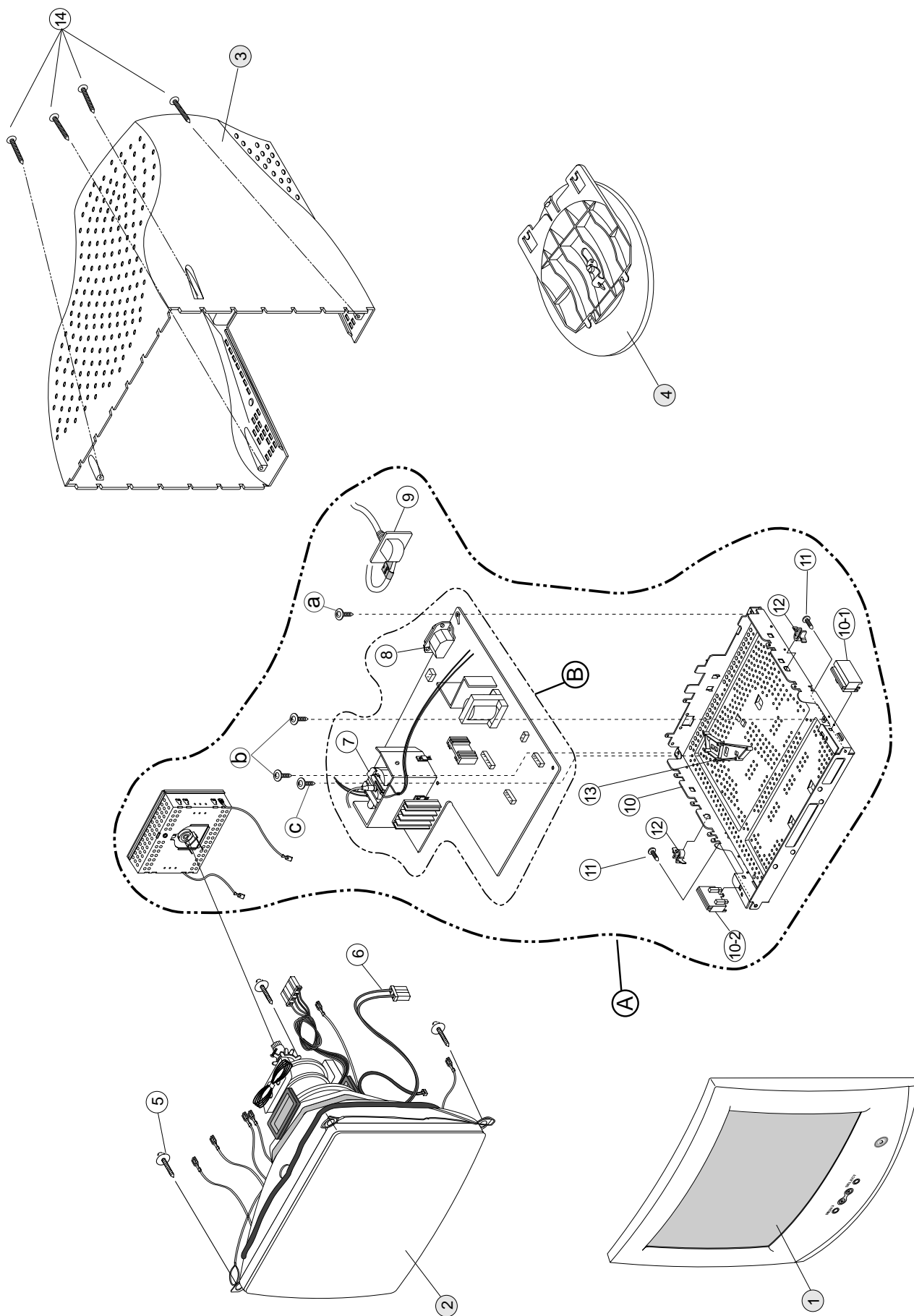

## EXPLODED VIEW PARTS LIST

Ref. No.	Part No.	Description
1	3091TKC048M	CABINET ASSEMBLY, CB773F BRAND C048 PC+ABS 85964 WA LOCAL <b>(CB773H-EL)</b>
	3091TKC048N	CABINET ASSEMBLY, CB773F BRAND C048 320T 85964 773N WA LOCAL <b>(CB773H-ML)</b>
	3091TKC048Q	CABINET ASSEMBLY, CB773F NO BRAND C048 320T 85964 WA LOCAL <b>(CB773H-NJ)</b>
	3091TKC048P	CABINET ASSEMBLY, CB773F NO BRAND C048 PC+ABS 85964 WA (TCO99 LABEL) <b>(CB773H-EJ)</b>
	3091TKC048R	CABINET ASSEMBLY, CB773F TINY C048 320T 15448 LOCAL <b>(TINY)</b>
2	6318L17006A	CDT(CIRC), M41LFQ803X 55NLUD LG-PHILIPS 70KHZ 29.1MM FST GREEN <b>(CB773H-EL), (CB773H-EJ)</b>
	6318L17005A	CDT(CIRC), M41LFQ803X55NLAA LG-PHILIPS 70KHZ 29.1MM <b>(CB773H-NJ), (CB773H-ML), (TINY)</b>
3	3809TKC028K	BACK COVER ASSEMBLY, CB773F C029 PC+ABS 85964 "A"CORE WA LOCAL <b>(CB773H-EL)</b>
	3809TKC028M	BACK COVER ASSEMBLY, CB773F C029 320T 85964 "A"CORE WA LOCAL <b>(CB773H-ML)</b>
	3809TKC028N	BACK COVER ASSEMBLY, CB773F C029 320T 85964 "B"CORE WA LOCAL <b>(CB773H-NJ)</b>
	3809TKC028J	BACK COVER ASSEMBLY, CB773F C029 PC+ABS 85964 "B" CORE <b>(CB773H-EJ) (CB773G-EK)</b>
	3809TKC028P	BACK COVER ASSEMBLY CB773F C029 "B"CORE 320T 15448 LOCAL <b>(TINY)</b>
4	3043TKK063K	TILT SWIVEL ASSY, CB773F B046/T051 60HR 85964 WA LOCAL
	3043TKK063M	TILT SWIVEL ASSEMBLY, CB773F B046/T051 60HR 15448 LOCAL <b>(TINY only)</b>
5	339-002H	SCREW ASSY, PHP+5*20(FZMY)+GW18 NEW TYPE #CDT FIX
6	6140TC3004A	COIL,DEGAUSSING, 1090MM 16.5OHM 0.4MM 110T 17" WITH EARTH
7	6174T11005A	FBT (FLY BACK TRANSFORMER), CF2077LG273A LIEN CHANGE 17"
8	6620TKB002D	SOCKET(CIRC),POWER, CDJ-3C DUOLING AC UNIVERSAL 3PIN BLACK
9	6850TA9009A	CABLE,D-SUB, UL2990-9C(5.8) AT 1560MM GRAY(85964) EB770H DM
10	4950TKS155A	METAL SHIELD BOTTOM, CB776
10-1	4810TKK153A	BRACKET, CB773D SUPPORTER CDT
10-2	4810TKK154A	BRACKET, CB773D SUPPORTER CDT(L)
11	332-102F	SCREW, PTP+4*20BP(MSWR/FZMY)
12	4930TKK031C	HOLDER PCB FIX , PC+ABS
13	4810TKK204A	BRACKET, CB777H HOLDER FBT
14	332-102F	SCREW, PTP+4*20BP(MSWR/FZMY)
A	3313T17279B	MAIN TOTAL ASSEMBLY CB773H BRAND CA-119
B	6871TMT363B	PWB(PCB) ASSEMBLY,MAIN, CB773H PLEUET BRAND CA-119 TOTAL
a	332-112F	SCREW,DRAWING, D3.5 L10.0 MSWR/FZMY +SW3.5+RW3.5
b	4001TKK004E	SCREW ASSEMBLY, TAPTITE P TYPE D3.0 L10.0 MSWR/FZMY SW3+RW10
c	332-095B	SCREW,DRAWING, PZP+3*10(MSWR/FZMY)

# REPLACEMENT PARTS LIST

**CAUTION:** BEFORE REPLACING ANY OF THESE COMPONENTS,  
 READ CAREFULLY THE **SAFETY PRECAUTIONS** IN THIS MANUAL.

\* NOTE : **S** SAFETY Mark   
**AL** ALTERNATIVE PARTS

DATE: 2002. 12. 10.				
*S	*AL	LOC. NO.	PART NO.	DESCRIPTION / SPECIFICATION
<b>CAPACITORS</b>				
			C301	0CK1040K945 0.1UF 50V Z F TR
			C302	0CK1040K945 0.1UF 50V Z F TR
			C303	0CK1040K945 0.1UF 50V Z F TR
			C305	181-288C MKT 100V 224JTR PHS 26224
			C306	0CE107CF638 100UF SHL,SD 16V M FM5 TP 5
			C307	0CK1040K945 0.1UF 50V Z F TR
			C308	0CK1040K945 0.1UF 50V Z F TR
			C309	0CK1040K945 0.1UF 50V Z F TR
			C310	0CE106CF638 10UF SHL,SD 16V M FM5 TP 5
			C311	0CK1040K945 0.1UF 50V Z F TR
			C312	0CK1040K945 0.1UF 50V Z F TR
			C313	0CE476CH638 47UF SHL,SD 25V M FM5 TP 5
			C314	0CK1010K515 100PF 50V K B TR
			C315	0CK10202515 1000PF D 2KV 10% TR B(Y5P)
			C325	0CK1040K945 0.1UF 50V Z F TR
			C326	0CK1010W515 100P 500V K B TS
			C327	0CK10302940 0.01M 2KV Z F S
			C328	0CK10302945 0.01UF 2KV Z F TR
			C330	181-288E MKT 100V 474JTR PHS 26474
			C331	0CC2200W415 22PF 500V J NP0 TR
			C332	0CK10301945 10000PF D 1KV Z F(Y5V) TR
			C346	0CE475CP638 4.7UF SHL,SD 160V M FM5 TP 5
			C380	0CE107CF638 100UF SHL,SD 16V M FM5 TP 5
			C384	0CC1500K415 15P 50V J NP0 TP
			C388	0CC1500K415 15P 50V J NP0 TP
			C389	0CE475CP638 4.7UF SHL,SD 160V M FM5 TP 5
			C390	0CK10301945 10000PF D 1KV Z F(Y5V) TR
			C397	0CE107CF638 100UF SHL,SD 16V M FM5 TP 5
			C401	0CK1040K945 0.1UF 50V Z F TR
			C402	0CE476CF638 47UF SHL,SD 16V M FM5 TP 5
			C403	0CK1040K945 0.1UF 50V Z F TR
			C406	0CK1010K515 100PF 50V K B TR
			C407	0CK1010K515 100PF 50V K B TR
			C408	0CK1040K945 0.1UF 50V Z F TR
			C409	0CK1010K515 100PF 50V K B TR
			C410	0CK1010K515 100PF 50V K B TR
			C416	0CE475CK638 4.7UF SHL,SD 50V M FM5 TP 5
			C501	0CE106CF638 10UF SHL,SD 16V M FM5 TP 5
			C599	0CE225CK638 2.2UF SHL,SD 50V M FM5 TP 5
			C601	0CE477CF618 470UF SHL 16V M FL TP5
			C603	0CE227CK618 220U SHL 50V M FL TP5
			C606	0CQ4721N419 0.0047U 100V J POLY NI TP5
			C611	0CE477CF618 470UF SHL 16V M FL TP5
			C613	181-288Q MKT 100V 154JTR PHS26154
			C614	0CE475CK638 4.7UF SHL,SD 50V M FM5 TP 5
			C615	0CQ4721N419 0.0047U 100V J POLY NI TP5
			C618	0CK1040K945 0.1UF 50V Z F TR
			C701	181-288B MKT 100V 104JTR PHS26104
			C702	0CE476CK638 47UF SHL,SD 50V M FM5 TP 5
			C703	0CK8210K515 820P 50V K B TS
			C704	0CQ1031N419 0.01U 100V J POLY NI TP
			C705	0CE475CK638 4.7UF SHL,SD 50V M FM5 TP 5
			C706	0CE105CK638 1UF SHL,SD 50V 20% FM5 TP 5

DATE: 2002. 12. 10.				
*S	*AL	LOC. NO.	PART NO.	DESCRIPTION / SPECIFICATION
			C708	0CE227CH638 220UF SHL,SD 25V M FM5 TP 5
			C709	0CE225CK638 2.2UF SHL,SD 50V M FM5 TP 5
			C710	181-288Q MKT 100V 154JTR PHS26154
			C711	181-288E MKT 100V 474JTR PHS 26474
			C712	181-288B MKT 100V 104JTR PHS26104
			C713	0CK2210K515 220P 50V K B TS
			C714	0CE107CF638 100UF SHL,SD 16V M FM5 TP 5
			C715	181-288N MKT 100V 103JTR PHS86103
			C717	0CE476CF638 47UF SHL,SD 16V M FM5 TP 5
			C719	0CZZTAB001F SHL-BP SYE / SWE 50V 3.3UF 20%
			C720	0CK27101515 270P 1KV K B TS
			C722	181-303R 304J 31.0*21.0*13.0*20.0 250V
			C723	181-305C 154J 19.0*14.0*8.0*10.0 250V J
			C724	0CK1040K945 0.1UF 50V Z F TR
			C725	0CK1510W515 150PF 500V K B TR
			C726	181-305H 394J 19.0*19.0*12.0*10.0 250V
			C727	0CN1040K949 0.1M 50V Z F TA52
			C728	0CQ5621N419 5600P 100V J POLY NI TP
			C729	181-305L 684J 26.0*19.0*12.5*15.0 250V
			C730	0CN1040K949 0.1M 50V Z F TA52
	⚠		C731	0CBZTBU004H 5600PF D 2.5KV H M/PP NI FM20
			C732	181-288N MKT 100V 103JTR PHS86103
			C733	0CBZTBU003H 362J 20.0*12.0*7.0*10.0 800V J
			C734	0CE2266F618 22M SMS 16V M FM5 TP(5)
			C736	0CQ2721N419 2700PF 100V J PE NI TP
			C737	0CK10102515 100PF D 2KV 10% B(Y5P) TR
			C738	181-302L 682J 19.5*12.0*7.0*10.0 250V J
			C739	0CE106EK638 10UF KMG 50V M FM5 TP 5
			C740	0CE227CL630 220U SHL 63V M FM5
			C741	0CZZTFT002B ECQV1H154JZ3 154J 50V TP5.0 MA
			C742	181-288K MKT 100V 683JTR PHS26683
			C743	0CE334CK638 0.33UF SHL,SD 50V 20% TP 5 FM5
			C744	0CZZTAB005A SMSHR SYE / SWE 160V 47UF 20%
			C745	0CK5610W515 560P 500V K B TS
			C746	0CK3310W515 330P 500V K B TS
			C747	181-288D MKT 100V 473JTR PHS26473
			C748	0CK1510W515 150PF 500V K B TR
			C749	0CE2256R638 2.2000UF SMS 250V M FM5 TP5
			C750	0CK1040K945 0.1UF 50V Z F TR
			C751	181-288J MKT 100V 563JTR PHS26563
			C752	0CQ4721N419 0.0047U 100V J POLY NI TP5
			C753	0CQ1021N419 1000P 100V J POLY NI TP
			C754	0CC4700W405 47PF 500V J SL TP
			C759	0CQ1821N419 1800P 100V J POLY NI TP
			C767	0CK10301945 10000PF D 1KV Z F(Y5V) TR
			C771	0CK10301945 10000PF D 1KV Z F(Y5V) TR
			C781	0CK1030K945 0.01UF 50V Z F TR
			C801	0CK1040K945 0.1UF 50V Z F TR
			C802	0CE106CK638 10UF SHL,SD 50V M FM5 TP 5
			C805	0CE106CK638 10UF SHL,SD 50V M FM5 TP 5
			C901	0CZZTFB001A BULK MPX 224K2YL (X2) BULK 22
			C902	0CZZTFB001A BULK MPX 224K2YL (X2) BULK 22
			C903	0CZZTCB003D BULK 7.5 CS E 102M 8.0 250V TD
			C904	0CZZTCB003A BULK 7.5 CS E 222M 10.5 250V T



DATE: 2002. 12. 10.				
*S	*AL	LOC. NO.	PART NO.	DESCRIPTION / SPECIFICATION
		C904	0CZZTCB003A	BULK 7.5 CS E 222M 10.5 250V T
		C905	0CZZTCB003A	BULK 7.5 CS E 222M 10.5 250V T
		C905	0CZZTCB003A	BULK 7.5 CS E 222M 10.5 250V T
		C906	0CZZTCB003D	BULK 7.5 CS E 102M 8.0 250V TD
		C907	0CZZTCB003C	BULK 7.5 CS E 472M 14.5 250V T
		C908	0CEZTBU002D	180UF 25.4*35 SMH/HC 400V M VN
		C909	0CK10301510	0.01M 1KV K B S
		C910	0CK27101515	270P 1KV K B TS
		C911	0CE475CK638	4.7UF SHL,SD 50V M FM5 TP 5
		C913	0CE476CK638	47UF SHL,SD 50V M FM5 TP 5
		C914	0CZZTFT001P	ECQB1H153JM3 153J 50V TP5.0 MA
		C915	0CK6810K515	680P 50V K B TS
		C917	0CK1020K515	1000PF 50V K B TR
		C918	0CN1040K949	0.1M 50V Z F TA52
		C941	0CE108CD618	1000UF SHL 10V M FL TP5
		C942	0CE107CF638	100UF SHL,SD 16V M FM5 TP 5
		C943	0CK56101515	560P 1KV K B TS
		C944	0CZZTCB003C	BULK 7.5 CS E 472M 14.5 250V T
		C946	0CK1010W515	100P 500V K B TS
		C951	0CE108CF630	1000UF SHL 16V M FM5 BULK
		C952	0CE227CF638	220UF SHL,SD 16V M FM5 TP 5
		C953	0CE107CF638	100UF SHL,SD 16V M FM5 TP 5
		C954	0CE108CF630	1000UF SHL 16V M FM5 BULK
		C971	0CE476CN618	47UF SHL 100V M FL TP5
		C999	0CE227CL630	220U SHL 63V M FM5
<b>DIODEs</b>				
		D201	0DLGP0010AB	XIAMEN G&P GP32052ME/512-ZY-1
		D301	0DS141489AB	1N4148 TP GRANDE DO-34 500MW 1
		D302	0DS141489AB	1N4148 TP GRANDE DO-34 500MW 1
		D303	0DS141489AB	1N4148 TP GRANDE DO-34 500MW 1
		D304	0DS141489AB	1N4148 TP GRANDE DO-34 500MW 1
		D305	0DS141489AB	1N4148 TP GRANDE DO-34 500MW 1
		D306	0DS141489AB	1N4148 TP GRANDE DO-34 500MW 1
		D307	0DS141489AB	1N4148 TP GRANDE DO-34 500MW 1
		D308	0DS141489AB	1N4148 TP GRANDE DO-34 500MW 1
		D309	0DS141489AB	1N4148 TP GRANDE DO-34 500MW 1
		D310	0DS124409AA	1SS244 TP ROHM KOREA
		D311	0DS124409AA	1SS244 TP ROHM KOREA
		D312	0DS124409AA	1SS244 TP ROHM KOREA
		D313	0DS141489AB	1N4148 TP GRANDE DO-34 500MW 1
		D399	0DR140059DA	1N4005TB52 TP LITEON DO41 600V
		D402	0DS141489AB	1N4148 TP GRANDE DO-34 500MW 1
		D404	971-0016	TIN HDC 0.60H
		D512	0DS141489AB	1N4148 TP GRANDE DO-34 500MW 1
		D602	0DRGF00069A	SB140 GULF TP DO41 40V 1A 40A
		D610	0DR100009CA	RGP10G TP GULF SEMICONDUCTOR L
		D610	0DR100009CA	RGP10G TP GULF SEMICONDUCTOR L
		D701	0DS141489AB	1N4148 TP GRANDE DO-34 500MW 1
		D702	0DS124409AA	1SS244 TP ROHM KOREA
		D703	0DRTW00050A	MUR460L-1121 TIWAN SEMI BK DO2
		D704	0DR150001AA	DTV1500MFP ST SGS-THOMSON TO22
		D705	0DRGF00069A	SB140 GULF TP DO41 40V 1A 40A
		D706	0DRGS00380B	GRD07-17L-5705 GENERAL SEMICON
		D709	971-0016	TIN HDC 0.60H
		D710	0DR400409AB	UF4004 TP G.I DO204AL 400V 1A
		D711	0DS141489AB	1N4148 TP GRANDE DO-34 500MW 1
		D712	0DR100009CA	RGP10G TP GULF SEMICONDUCTOR L
		D712	0DR100009CA	RGP10G TP GULF SEMICONDUCTOR L
		D713	0DS141489AB	1N4148 TP GRANDE DO-34 500MW 1
		D714	0DS141489AB	1N4148 TP GRANDE DO-34 500MW 1

DATE: 2002. 12. 10.				
*S	*AL	LOC. NO.	PART NO.	DESCRIPTION / SPECIFICATION
		D715	0DS141489AB	1N4148 TP GRANDE DO-34 500MW 1
		D716	0DR140059DA	1N4005TB52 TP LITEON DO41 600V
		D717	0DR140059DA	1N4005TB52 TP LITEON DO41 600V
		D718	0DR140059DA	1N4005TB52 TP LITEON DO41 600V
		D719	0DR100009DA	RGP10J TP GULF SEMICONDUCTOR L
		D720	0DS141489AB	1N4148 TP GRANDE DO-34 500MW 1
		D721	0DS141489AB	1N4148 TP GRANDE DO-34 500MW 1
		D723	0DS141489AB	1N4148 TP GRANDE DO-34 500MW 1
		D724	0DR140059DA	1N4005TB52 TP LITEON DO41 600V
		D767	0DR100009DA	RGP10J TP GULF SEMICONDUCTOR L
		D768	971-0016	TIN HDC 0.60H
		D801	0DS141489AB	1N4148 TP GRANDE DO-34 500MW 1
		D802	0DS141489AB	1N4148 TP GRANDE DO-34 500MW 1
		D803	0DS141489AB	1N4148 TP GRANDE DO-34 500MW 1
		D900	0DRTW00071A	TS4B05G-1021 TIWAN SEMI ST NON
		D902	0DR153979AA	1N5397GP TP G.I DO201AD 600V 1
		D904	0DR100009CA	RGP10G TP GULF SEMICONDUCTOR L
		D904	0DR100009CA	RGP10G TP GULF SEMICONDUCTOR L
		D905	0DD400709CB	UF4007 TP G.I DO204AL 1000V 1
		D906	0DR100009CA	RGP10G TP GULF SEMICONDUCTOR L
		D906	0DR100009CA	RGP10G TP GULF SEMICONDUCTOR L
		D908	0DS141489AB	1N4148 TP GRANDE DO-34 500MW 1
		D910	0DS141489AB	1N4148 TP GRANDE DO-34 500MW 1
		D911	0DS141489AB	1N4148 TP GRANDE DO-34 500MW 1
		D941	0DR100009LA	UG1D TP G.I DO204AL 200V 1A 40
		D942	0DR400409AB	UF4004 TP G.I DO204AL 400V 1A
		D951	0DRTW00044B	UG2DL-1021 TIWAN SEMI BK DO15
		D952	0DS141489AB	1N4148 TP GRANDE DO-34 500MW 1
		D961	0DRTW00060A	SF38GL-1121 TIWAN SEMI BK DO20
		D971	0DR100009DA	RGP10J TP GULF SEMICONDUCTOR L
		ZD402	0DZ560009AG	GDZJ5.6B TP GRANDE DO-34 500MW
		ZD403	0DZ560009AG	GDZJ5.6B TP GRANDE DO-34 500MW
		ZD404	0DZ560009AG	GDZJ5.6B TP GRANDE DO-34 500MW
		ZD405	0DZ560009AG	GDZJ5.6B TP GRANDE DO-34 500MW
		ZD407	0DZ560009AG	GDZJ5.6B TP GRANDE DO-34 500MW
		ZD408	0DZ560009AG	GDZJ5.6B TP GRANDE DO-34 500MW
		ZD409	0DZ560009AG	GDZJ5.6B TP GRANDE DO-34 500MW
		ZD410	0DZ560009AG	GDZJ5.6B TP GRANDE DO-34 500MW
		ZD701	0DZ120009BF	GDZJ12B TP GRANDE DO34 0.5W 12
		ZD702	971-0016	TIN HDC 0.60H
		ZD902	0DZ510009BE	GDZ5.1B TP GRANDE DO34 500MW 5
<b>ICs</b>				
		IC301	0IPRPWL001A	6805-N160WT-87A WELTREND 16, P
		IC302	0IPRPSG014A	STV9211 SGS-THOMSON 20P,DIP ST
		IC303	0IPRPSG004B	STV9556 SGS-THOMSON 11P,CLIPWA
		IC401	0IZZTSZ223A	"SS 42PIN SDIP ST OTP 17" H4 ST"
		IC402	0ISG240860A	M24C08-BN6 8DIP BK 8K SERIAL I
		IC601	0IPRPSG016A	STV9302A SGS-THOMSON TO220,7P
		IC701	0IPRPSG017A	STV6888 SGS-THOMSON 32P,SDIP S
		IC901	0ISS384200A	KA3842B (PWM)
<b>COILs &amp; COREs</b>				
		L301	0LA0560K119	0.56UH K 2.3*3.4 TP
		L302	0LA0560K119	0.56UH K 2.3*3.4 TP
		L303	0LA0560K119	0.56UH K 2.3*3.4 TP
		L304	0LA1000K119	100UH K 2.3*3.4 TP
		L702	6140TBZ025C	DR14*20 150UH 0.12*25MM 51T H-
		L703	6140TYZ010G	LX31 GET DR14*15-C5.2,16.5T,4.
		L705	6140TBZ026C	DR15*18-C9.8 100UH 0.1*30MM 40
		L901	6200TZZ004A	SQE2626 NAMYANG BK L/FILTER 15

DATE: 2002. 12. 10.				
*S	*AL	LOC. NO.	PART NO.	DESCRIPTION / SPECIFICATION
		L903	6200J00003A	RH3.5*5.0 BOSUNG TP
		FB303	6210TCE003A	BRD3510B BO SUNG 3510MM RADIAL
		FB304	6210TCE003J	BAS2550T BO SUNG 2550MM AXIAL5
		FB305	6210TCE003A	BRD3510B BO SUNG 3510MM RADIAL
		FB306	6210TCE003A	BRD3510B BO SUNG 3510MM RADIAL
		FB314	6210TCZ001J	BAS3550T0(125-022J) BO SUNG RH
		FB315	6210TCZ001J	BAS3550T0(125-022J) BO SUNG RH
		FB316	6210TCZ001J	BAS3550T0(125-022J) BO SUNG RH
		FB401	971-0016	TIN HDC 0.60H
		FB402	6210TCE003L	BAS3580T BO SUNG 3580MM AXIAL5
		FB403	6210TCE003J	BAS2550T BO SUNG 2550MM AXIAL5
		FB501	6210TCE003P	BRS2550B BO SUNG 2550MM RADIAL
		FB502	6210TCE003J	BAS2550T BO SUNG 2550MM AXIAL5
		FB701	6210TCE003L	BAS3580T BO SUNG 3580MM AXIAL5
		FB703	6210TCE003B	BRS3580B BO SUNG 3580MM RADIAL
		FB705	971-0016	TIN HDC 0.60H
		FB903	6210TCE003P	BRS2550B BO SUNG 2550MM RADIAL
		FB904	6210TCE003K	BAS3550T BO SUNG 3550MM AXIAL5
		FB905	6210TCE003P	BRS2550B BO SUNG 2550MM RADIAL
		FB921	6210TCE003A	BRD3510B BO SUNG 3510MM RADIAL
		FB922	6210TCE003L	BAS3580T BO SUNG 3580MM AXIAL5
		FB951	971-0016	TIN HDC 0.60H
		FB952	6210TCE003G	BRS3550B BO SUNG 3550MM RADIAL
<b>TRANSISTOR</b>				
		Q301	0TR100809AA	KSC1008C-Y TP SAMSUNG TO92 NP
		Q501	0TR320209AA	KTC3202-Y(KTC1959) TP KEC TO92
		Q502	0TR127009AA	KTA1270-Y(KTA562TM) TP KEC TO9
		Q503	0TR319809AA	KTC3198-Y(KTC1815) TP KEC TO92
		Q701	0TR319809AA	KTC3198-Y(KTC1815) TP KEC TO92
		Q703	0TR127009AA	KTA1270-Y(KTA562TM) TP KEC TO9
		Q704	0TR320209AA	KTC3202-Y(KTC1959) TP KEC TO92
		Q705	0TR100809AA	KSC1008C-Y TP SAMSUNG TO92 NP
		Q706	0TRTH10005B	2SC5855(LG1) TOSHIBA ST TO3P 1
		Q707	0TR127009AA	KTA1270-Y(KTA562TM) TP KEC TO9
		Q708	0TR127009AA	KTA1270-Y(KTA562TM) TP KEC TO9
		Q709	0TR141300AB	KTD1413 BK KEC TO220I S NPN
		Q710	0TR440009CA	KSP44 TP SAMSUNG
		Q711	0TF630000DA	IRF630A BK SAMSUNG 200V 9A TO2
		Q712	0TF630000DA	IRF630A BK SAMSUNG 200V 9A TO2
		Q713	0TF630000DA	IRF630A BK SAMSUNG 200V 9A TO2
		Q714	0TR319809AA	KTC3198-Y(KTC1815) TP KEC TO92
		Q715	0TR319809AA	KTC3198-Y(KTC1815) TP KEC TO92
		Q716	0TR319809AA	KTC3198-Y(KTC1815) TP KEC TO92
		Q717	0TR100809AA	KSC1008C-Y TP SAMSUNG TO92 NP
		Q719	0TF630000DA	IRF630A BK SAMSUNG 200V 9A TO2
		Q799	0TR920009AB	KSP92 TP SAMSUNG TO92 HIGH VOL
		Q901	0TF760000AD	SSS7N60B FAIRCHILD ST TO220F 6
		Q903	0TR100809AA	KSC1008C-Y TP SAMSUNG TO92 NP
		Q941	0TR319809AA	KTC3198-Y(KTC1815) TP KEC TO92
		Q942	0TR928009AB	KSA928A-Y TP SAMSUNG TO92L PNP
		Q951	0TR319809AA	KTC3198-Y(KTC1815) TP KEC TO92
		Q952	0TR928009AB	KSA928A-Y TP SAMSUNG TO92L PNP
		Q953	0TR319809AA	KTC3198-Y(KTC1815) TP KEC TO92
<b>RESISTORS</b>				
		R301	0RD0752Q609	75 1/4W(3 5% TA52
		R302	0RD0752Q609	75 1/4W(3 5% TA52
		R303	0RD0752Q609	75 1/4W(3 5% TA52
		R304	0RD3001Q609	3K 1/4W(3 5% TA52

DATE: 2002. 12. 10.				
*S	*AL	LOC. NO.	PART NO.	DESCRIPTION / SPECIFICATION
		R305	0RD1001Q609	1K 1/4W(3 5% TA52
		R307	0RD1001Q609	1K 1/4W(3 5% TA52
		R309	0RN6201F409	6.20K 1/6W 1% TA52
		R311	0RD0271Q609	2.70 1/4W(3 5% TA52
		R312	0RD2001Q609	2K 1/4W(3 5% TA52
		R313	0RD1000Q609	100 1/4W(3 5% TA52
		R314	0RD6800Q609	680 1/4W(3 5% TA52
		R317	0RD2001Q609	2K 1/4W(3 5% TA52
		R319	0RD1000Q609	100 1/4W(3 5% TA52
		R320	0RD1000Q609	100 1/4W(3 5% TA52
		R321	0RD0152Q609	15 1/4W(3 5% TA52
		R322	0RD0152Q609	15 1/4W(3 5% TA52
		R323	0RD0152Q609	15 1/4W(3 5% TA52
		R324	0RD3300Q609	330 1/4W(3 5% TA52
		R325	0RD3300Q609	330 1/4W(3 5% TA52
		R326	0RD3300Q609	330 1/4W(3 5% TA52
		R327	0RD3300Q609	330 1/4W(3 5% TA52
		R331	0RD0512Q609	51 1/4W(3 5% TA52
		R332	0RD0512Q609	51 1/4W(3 5% TA52
		R333	0RD0512Q609	51 1/4W(3 5% TA52
		R335	0RD0271Q609	2.70 1/4W(3 5% TA52
		R336	0RD1000Q609	100 1/4W(3 5% TA52
		R337	0RD1000Q609	100 1/4W(3 5% TA52
		R341	0RD1800Q609	180 1/4W(3 5% TA52
		R342	0RD1300Q609	130 1/4W(3 5% TA52
		R343	0RD1300Q609	130 1/4W(3 5% TA52
		R344	971-0016	TIN HDC 0.60H
		R351	0RD2200A609	220 OHM 1/2 W (7.0) 5% TA52
		R352	0RD2200A609	220 OHM 1/2 W (7.0) 5% TA52
		R353	0RD2200A609	220 OHM 1/2 W (7.0) 5% TA52
		R354	0RD0392A609	39 OHM 1/2 W (7.0) 5% TA52
		R382	0RD1000Q609	100 1/4W(3 5% TA52
		R383	0RD1000Q609	100 1/4W(3 5% TA52
		R401	0RD1000Q609	100 1/4W(3 5% TA52
		R402	0RD5600Q609	560 1/4W(3 5% TA52
		R403	0RD1002Q609	10K 1/4W(3 5% TA52
		R404	0RD3002Q609	30K 1/4W(3 5% TA52
		R405	0RD2001Q609	2K 1/4W(3 5% TA52
		R406	0RD2001Q609	2K 1/4W(3 5% TA52
		R407	0RD1300Q609	130 1/4W(3 5% TA52
		R408	0RD1300Q609	130 1/4W(3 5% TA52
		R409	0RD1000Q609	100 1/4W(3 5% TA52
		R410	0RD1000Q609	100 1/4W(3 5% TA52
		R412	0RD1004Q609	1M OHM 1/4 W (3.4) 5% TA52
		R414	0RD4701Q609	4.70K 1/4W(3 5% TA52
		R417	0RD1000Q609	100 1/4W(3 5% TA52
		R418	0RD1002Q609	10K 1/4W(3 5% TA52
		R419	0RD1004Q609	1M OHM 1/4 W (3.4) 5% TA52
		R424	0RD2200Q609	220 1/4W(3 5% TA52
		R425	0RD4701Q609	4.70K 1/4W(3 5% TA52
		R426	0RD4701Q609	4.70K 1/4W(3 5% TA52
		R429	0RD1000Q609	100 1/4W(3 5% TA52
		R430	0RD1000Q609	100 1/4W(3 5% TA52
		R431	0RD4701Q609	4.70K 1/4W(3 5% TA52
		R432	0RD1000Q609	100 1/4W(3 5% TA52
		R433	0RD1000Q609	100 1/4W(3 5% TA52
		R434	0RD1000Q609	100 1/4W(3 5% TA52
		R438	0RD1001Q609	1K 1/4W(3 5% TA52
		R439	0RD1001Q609	1K 1/4W(3 5% TA52
		R441	0RD2200Q609	220 1/4W(3 5% TA52
		R442	0RD2200Q609	220 1/4W(3 5% TA52
		R443	0RD0912Q609	91 OHM 1/4 W (3.4) 5% TA52

DATE: 2002. 12. 10.				
*S	*AL	LOC. NO.	PART NO.	DESCRIPTION / SPECIFICATION
		R446	ORD1002Q609	10K 1/4W(3 5% TA52
		R447	ORD1001Q609	1K 1/4W(3 5% TA52
		R448	ORD1801Q609	1.80K 1/4W(3 5% TA52
		R490	ORD9100Q609	910 1/4W(3 5% TA52
		R491	ORD2200Q609	220 1/4W(3 5% TA52
		R492	ORD4300Q609	430 OHM 1/4 W(3.4) 5.00% TA52
		R493	ORD7500Q609	750 OHM 1/4 W (3.4) 5% TA52
		R494	ORD1001Q609	1K 1/4W(3 5% TA52
		R495	ORD1001Q609	1K 1/4W(3 5% TA52
		R501	ORD0102A609	10 OHM 1/2 W (7.0) 5% TA52
		R508	ORD4702Q609	47K 1/4W(3 5% TA52
		R515	ORD1502Q609	15K 1/4W(3 5% TA52
		R597	ORD3902Q609	39K 1/4W(3 5% TA52
		R598	ORD5601Q609	5.60K 1/4W(3 5% TA52
		R599	ORD0202A609	20 OHM 1/2 W (7.0) 5% TA52
		R602	ORN3300F409	330 1/6W 1% TA52
		R604	ORN1801F409	1.80K 1/6W 1% TA52
		R607	ORN5101F409	5.10K 1/6W 1% TA52
		R608	ORN2002F409	20K 1/6W 1% TA52
		R609	ORN1102F409	11K 1/6W 1% TA52
		R611	ORD0151A609	1.5 OHM 1/2 W (7.0) 5% TA52
		R612	ORD2700A609	270 OHM 1/2 W (7.0) 5% TA52
		R614	ORD0111A609	1.1 OHM 1/2 W (7.0) 5% TA52
		R615	ORN1202F409	12K 1/6W 1% TA52
		R619	ORN2001F409	2K OHM 1/6 W 1.00% TA52
		R700	971-0016	TIN HDC 0.60H
		R701	ORN6201F409	6.20K 1/6W 1% TA52
		R702	ORD2001Q609	2K 1/4W(3 5% TA52
		R703	ORD1001Q609	1K 1/4W(3 5% TA52
		R704	ORD6202Q609	62K OHM 1/4 W (3.4) 5% TA52
		R705	ORD3003Q609	300K 1/4W(3 5% TA52
		R706	ORD1002Q609	10K 1/4W(3 5% TA52
		R707	ORD1001Q609	1K 1/4W(3 5% TA52
		R708	ORD1102Q609	11K 1/4W(3 5% TA52
△		R709	ORN1002F409	10K 1/6W 1 TA52
		R710	ORD1000Q609	100 1/4W(3 5% TA52
		R711	ORD1000Q609	100 1/4W(3 5% TA52
		R712	ORD1501Q609	1.50K 1/4W(3 5% TA52
△		R713	ORN8202F409	82K 1/6W 1% TA52
△		R714	ORN1102F409	11K 1/6W 1% TA52
		R716	ORD1002Q609	10K 1/4W(3 5% TA52
		R717	ORD2701Q609	2.70K 1/4W(3 5% TA52
		R718	ORD0242Q609	24 1/4W(3 5% TA52
△		R719	ORD1001Q609	1K 1/4W(3 5% TA52
		R720	ORD1803Q609	180K 1/4W(3 5% TA52
		R721	971-0016	TIN HDC 0.60H
		R722	ORD1001Q609	1K 1/4W(3 5% TA52
		R723	ORD1001Q609	1K 1/4W(3 5% TA52
		R724	ORD1001Q609	1K 1/4W(3 5% TA52
		R726	ORD7502A609	75K OHM 1/2 W (7.0) 5% TA52
		R727-1	ORX0911K665	9.1 OHM 2 W 5% SF
		R728	ORD1001Q609	1K 1/4W(3 5% TA52
		R729	ORD1002Q609	10K 1/4W(3 5% TA52
		R731	ORD1002Q609	10K 1/4W(3 5% TA52
		R732	ORD6802Q509	68K OHM 1/4 W (3.4) 2% TA52
		R733	971-0016	TIN HDC 0.60H
		R735	ORD1002Q609	10K 1/4W(3 5% TA52
		R736	ORX2201J609	2.2KOHM 1 W 5% TA52
		R737	ORN0560H609	0.56 1/2W 5 TA52
		R738	ORN0560H609	0.56 1/2W 5 TA52
		R739	ORD1503Q609	150K 1/4W(3 5% TA52
		R740	ORD0271A609	2.7 OHM 1/2 W (7.0) 5% TA52

DATE: 2002. 12. 10.				
*S	*AL	LOC. NO.	PART NO.	DESCRIPTION / SPECIFICATION
		R741	ORD1000Q609	100 1/4W(3 5% TA52
		R742	ORD3601Q609	3.60K 1/4W(3 5% TA52
		R743	ORD4701Q609	4.70K 1/4W(3 5% TA52
		R744	ORD2700A609	270 OHM 1/2 W (7.0) 5% TA52
		R745	ORD4702Q609	47K 1/4W(3 5% TA52
		R746	ORD2201Q609	2.20K 1/4W(3 5% TA52
		R747	ORD3001Q609	3K 1/4W(3 5% TA52
		R748	ORD4702Q609	47K 1/4W(3 5% TA52
		R749	ORD2201Q609	2.20K 1/4W(3 5% TA52
		R750	ORD3001Q609	3K 1/4W(3 5% TA52
		R751	ORD2001Q609	2K 1/4W(3 5% TA52
		R752	ORD2201Q609	2.20K 1/4W(3 5% TA52
		R753	ORD3001Q609	3K 1/4W(3 5% TA52
		R754	ORD1002Q609	10K 1/4W(3 5% TA52
		R755	ORD3301Q609	3.30K 1/4W(3 5% TA52
		R756	ORD2202A609	22K OHM 1/2 W (7.0) 5% TA52
		R757	ORD2402Q609	24K 1/4W(3 5% TA52
		R758	ORN1303F409	130K 1/6W 1% TA52
		R759	ORD1302Q509	13K OHM 1/4 W (3.4) 2% TA52
		R760	ORD5103Q609	510K 1/4W(3 5% TA52
		R761	ORD3001Q609	3K 1/4W(3 5% TA52
		R762	ORD3001Q609	3K 1/4W(3 5% TA52
		R763	ORD3001Q609	3K 1/4W(3 5% TA52
		R764	971-0016	TIN HDC 0.60H
		R765	ORD3000A609	300 OHM 1/2 W (7.0) 5% TA52
		R766	ORD6200A609	620 OHM 1/2 W(7.0) 5.00% TA52
		R767	971-0016	TIN HDC 0.60H
		R768	ORD5103A609	510K OHM 1/2 W (7.0) 5% TA52
		R769	971-0016	TIN HDC 0.60H
		R771	ORN2001F409	2K OHM 1/6 W 1.00% TA52
		R772	ORN2401F409	2.40K 1/6W 1% TA52
		R773	ORD6202A609	62K OHM 1/2 W (7.0) 5% TA52
		R779	ORD3601Q509	3.6K OHM 1/4 W(3.4) 2% TA52
		R782	ORD3301A609	3.3K OHM 1/2 W(7.0) 5.00% TA52
		R783	971-0016	TIN HDC 0.60H
		R784	971-0016	TIN HDC 0.60H
		R786	ORD4302Q609	43K 1/4W(3 5% TA52
		R789	OCK3310W515	330P 500V K B TS
		R790	ORD1002Q609	10K 1/4W(3 5% TA52
		R793	ORD4702Q609	47K 1/4W(3 5% TA52
		R797	ORD1501Q609	1.50K 1/4W(3 5% TA52
		R798	ORD2001Q609	2K 1/4W(3 5% TA52
		R799	ORD1502Q609	15K 1/4W(3 5% TA52
		R801	ORD4702Q609	47K 1/4W(3 5% TA52
		R802	ORD1502Q609	15K 1/4W(3 5% TA52
		R803	ORD2001Q609	2K 1/4W(3 5% TA52
		R804	971-0016	TIN HDC 0.60H
		R808	971-0016	TIN HDC 0.60H
		R809	ORX0101K665	1 OHM 2 W 5% SF
		R813	ORD6802Q609	68K 1/4W(3 5% TA52
		R814	ORD1202Q609	12K 1/4W(3 5% TA52
△		R816	ORN1801F409	1.80K 1/6W 1% TA52
△		R818	ORN3602F409	36K 1/6W 1 TA52
		R824	ORD2400A609	240 OHM 1/2 W (7.0) 5% TA52
		R901	ORD4703A609	470K OHM 1/2 W (7.0) 5% TA52
		R902	ORD0511Q609	5.1 OHM 1/4 W (3.4) 5% TA52
		R904	ORX3902K665	39K OHM 2 W 5% SF
		R906	ORD6200Q609	620 1/4W(3 5% TA52
		R908	ORN0220H609	0.22 1/2W 5% TA52
		R910	ORX4702J609	47K OHM 1 W 5% TA52
		R911	ORD0202Q609	20 1/4W(3 5% TA52
△		R912	ORD1802Q609	18K 1/4W(3 5% TA52



# PIN CONFIGURATION

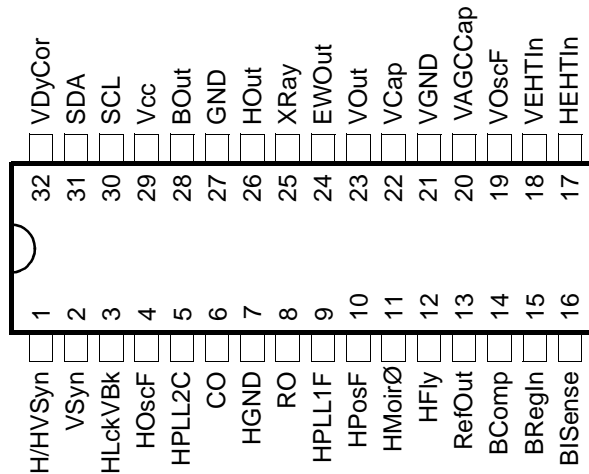

Pin	Name	Function
1	H/HV <sub>Syn</sub>	TTL compatible <b>H</b> orizontal / <b>H</b> orizontal and <b>V</b> ertical <b>S</b> ync. input
2	VS <sub>yn</sub>	TTL compatible <b>V</b> ertical <b>S</b> ync. input
3	HL <sub>ckVBk</sub>	<b>H</b> orizontal PLL1 <b>L</b> ock detection and <b>V</b> ertical early <b>B</b> lanking composite output
4	HO <sub>scF</sub>	High <b>H</b> orizontal <b>O</b> scillator sawtooth threshold level <b>F</b> ilter input
5	HP <sub>LL2C</sub>	<b>H</b> orizontal <b>P</b> LL2 loop <b>C</b> apacitive filter input
6	CO	Horizontal <b>O</b> scillator <b>C</b> apacitor input
7	H <sub>GND</sub>	<b>H</b> orizontal section <b>G</b> rou <b>N</b> D
8	RO	Horizontal <b>O</b> scillator <b>R</b> esistor input
9	HP <sub>LL1F</sub>	<b>H</b> orizontal <b>P</b> LL1 loop <b>F</b> ilter input
10	HP <sub>osF</sub>	<b>H</b> orizontal <b>P</b> osition <b>F</b> ilter and soft-start time constant capacitor input
11	HM <sub>oir</sub> Ø	<b>H</b> orizontal <b>M</b> oirØ output
12	HF <sub>ly</sub>	<b>H</b> orizontal <b>F</b> lyback input
13	Re <sub>fOut</sub>	<b>R</b> eference voltage <b>O</b> utput
14	BC <sub>omp</sub>	<b>B</b> + DC/DC error amplifier ( <b>C</b> omparator) output
15	BR <sub>egIn</sub>	<b>R</b> egulation feedback <b>I</b> nput of the <b>B</b> + DC/DC converter controller
16	BI <sub>Sense</sub>	<b>B</b> + DC/DC converter current ( <b>I</b> ) <b>S</b> ense input
17	HEHT <sub>In</sub>	<b>I</b> nput for compensation of <b>H</b> orizontal amplitude versus <b>E</b> HT variation
18	VEHT <sub>In</sub>	<b>I</b> nput for compensation of <b>V</b> ertical amplitude versus <b>E</b> HT variation
19	V <sub>OscF</sub>	<b>V</b> ertical <b>O</b> scillator sawtooth low threshold <b>F</b> ilter (capacitor to be connected to V <sub>GND</sub> )
20	V <sub>AGCCap</sub>	<b>I</b> nput for storage <b>C</b> apacitor for <b>A</b> utomatic <b>G</b> ain <b>C</b> ontrol loop in <b>V</b> ertical oscillator
21	V <sub>GND</sub>	<b>V</b> ertical section <b>G</b> rou <b>N</b> D
22	V <sub>Cap</sub>	<b>V</b> ertical sawtooth generator <b>C</b> apacitor
23	V <sub>Out</sub>	<b>V</b> ertical deflection drive <b>O</b> utput for a DC-coupled output stage
24	E <sub>WOut</sub>	<b>E</b> / <b>W</b> <b>O</b> utput
25	X <sub>Ray</sub>	<b>X</b> - <b>R</b> ay protection input
26	H <sub>Out</sub>	<b>H</b> orizontal drive <b>O</b> utput
27	GND	Main <b>G</b> rou <b>N</b> D
28	B <sub>Out</sub>	<b>B</b> + DC/DC converter controller <b>O</b> utput
29	V <sub>cc</sub>	Supply voltage
30	SCL	I <sup>2</sup> C bus <b>S</b> erial <b>C</b> lock <b>I</b> nput
31	SDA	I <sup>2</sup> C bus <b>S</b> erial <b>D</b> Ata input/output
32	V <sub>DyCor</sub>	<b>V</b> ertical <b>D</b> ynamic <b>C</b> orrection output

Block Diagram

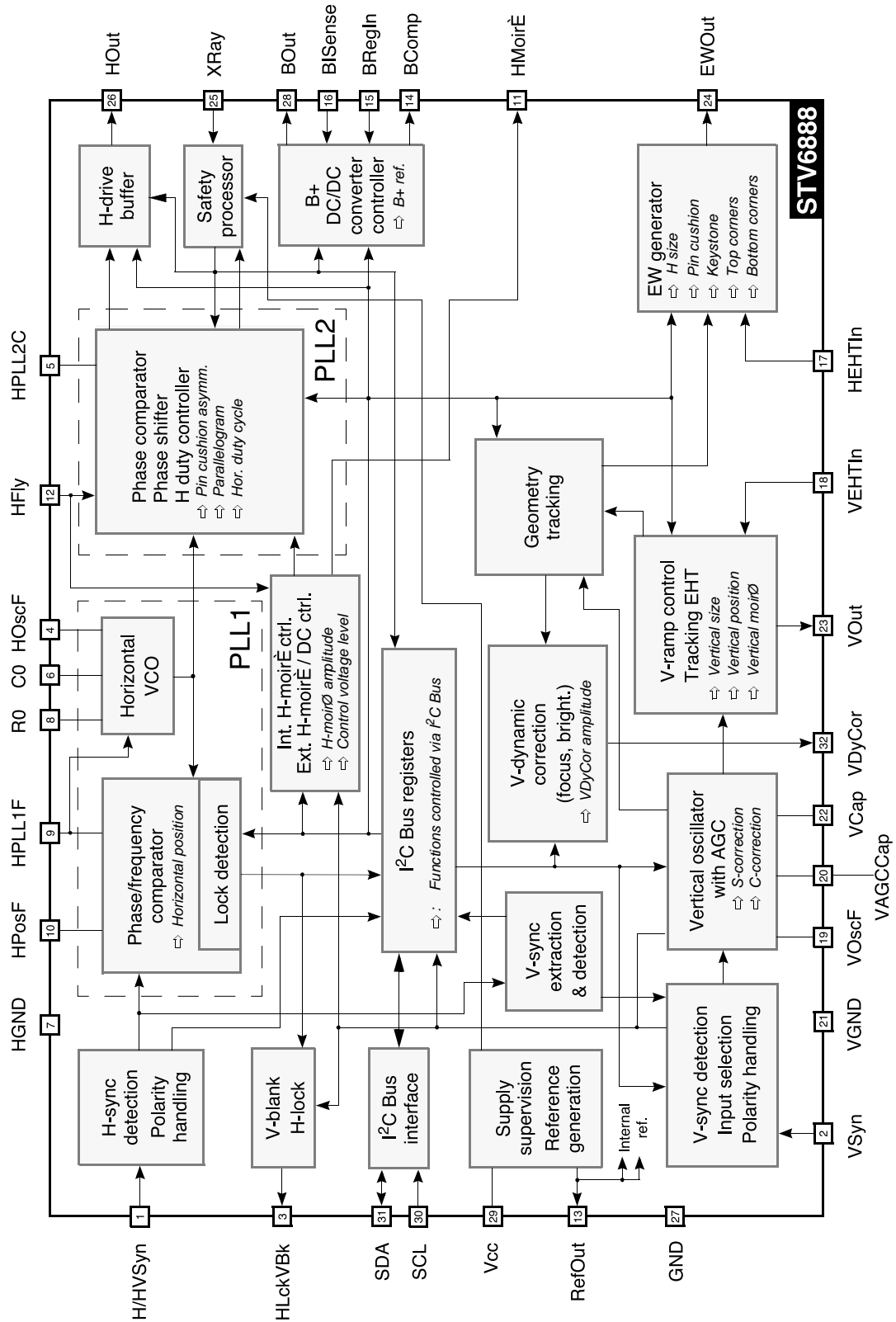

## STV9211

### Pin Configuration

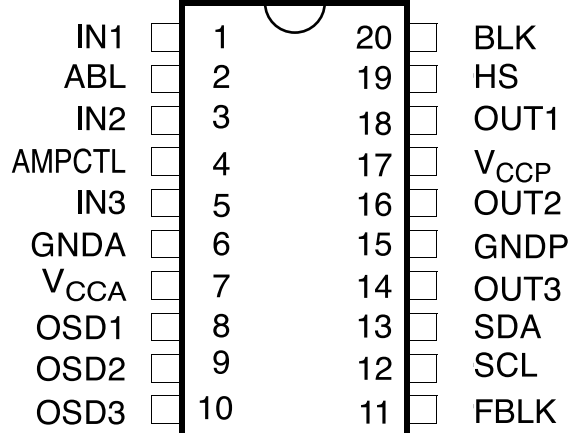

### Pin Description

Pin number	symbol	description
1	IN1	Video input (channel 1, red)
2	ABL	ABL input
3	IN2	Video input (channel 2, green)
4	AMPCTL	Amplifier control (bandwidth and stand-by). Only applicable with amplifiers with the CTL or STDBY pins. To be connected to ground if not used.
5	IN3	Video input (channel 3, blue)
6	GNDA	Analog ground
7	V <sub>CCA</sub>	Analog supply (5V)
8	OSD1	OSD input (channel 1, red)
9	OSD2	OSD input (channel 2, green)
10	OSD3	OSD input (channel 3, blue)
11	FBLK	Fast blanking
12	SCL	SCL
13	SDA	SDA
14	OUT3	Video output (channel 3, blue)
15	GNDP	Power ground
16	OUT2	Video output (channel 2, green)
17	V <sub>CCP</sub>	Output stage supply (5 V to 8 V)
18	OUT1	Video output (channel 1, red)
19	HS	Horizontal synchro or BPCP pulse
20	BLK	Blanking input

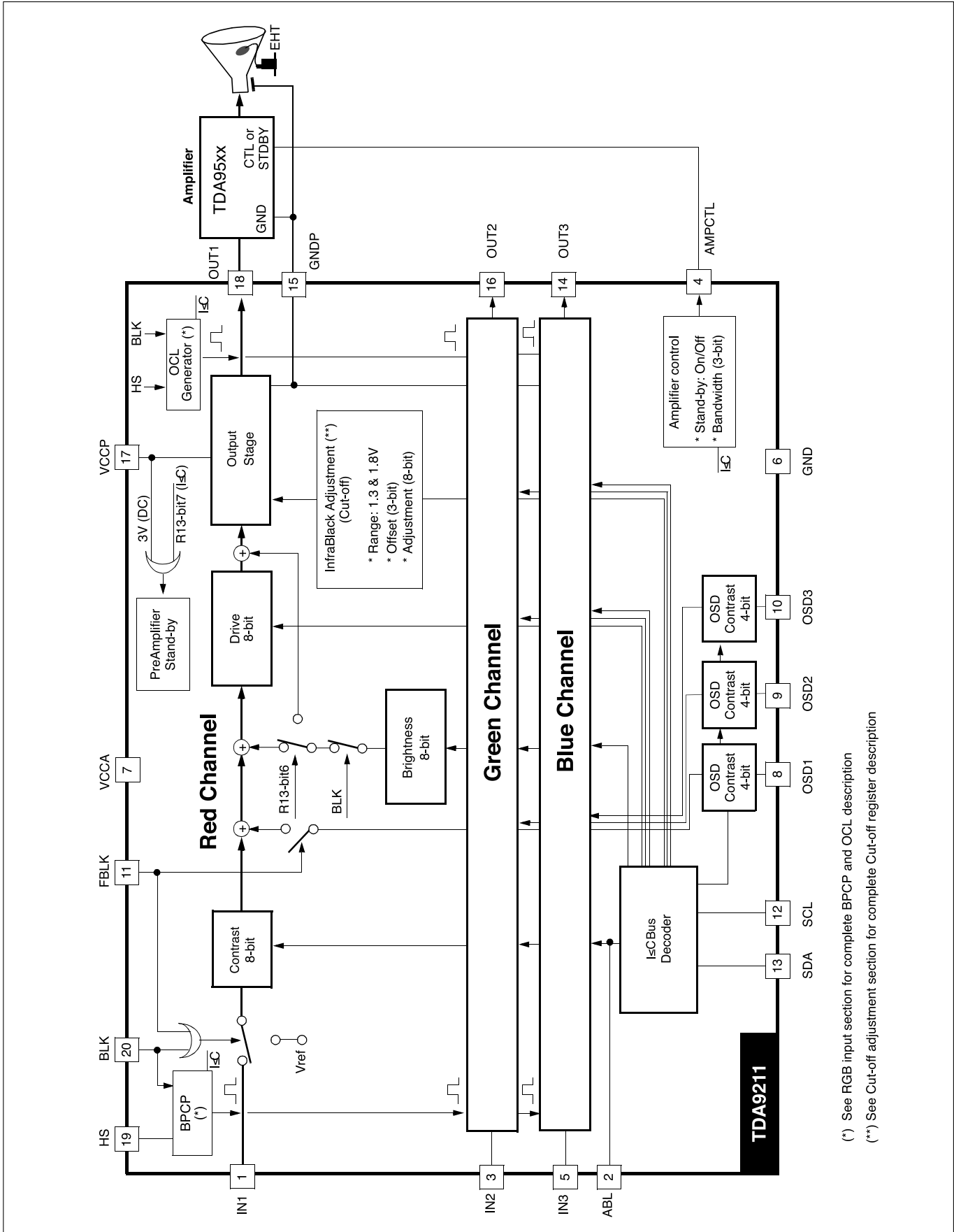

(\*) See RGB input section for complete BPCP and OCL description

(\*\*) See Cut-off adjustment section for complete Cut-off register description



# STV9556

## Pin Configuration

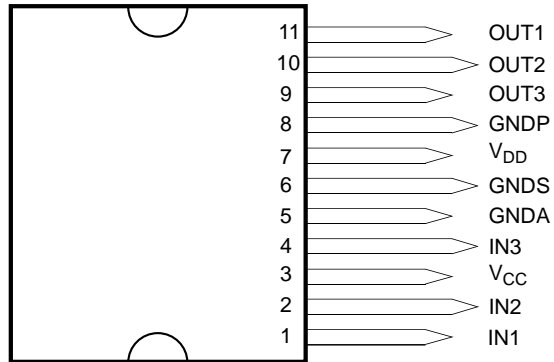

## BLOCK DIAGRAM

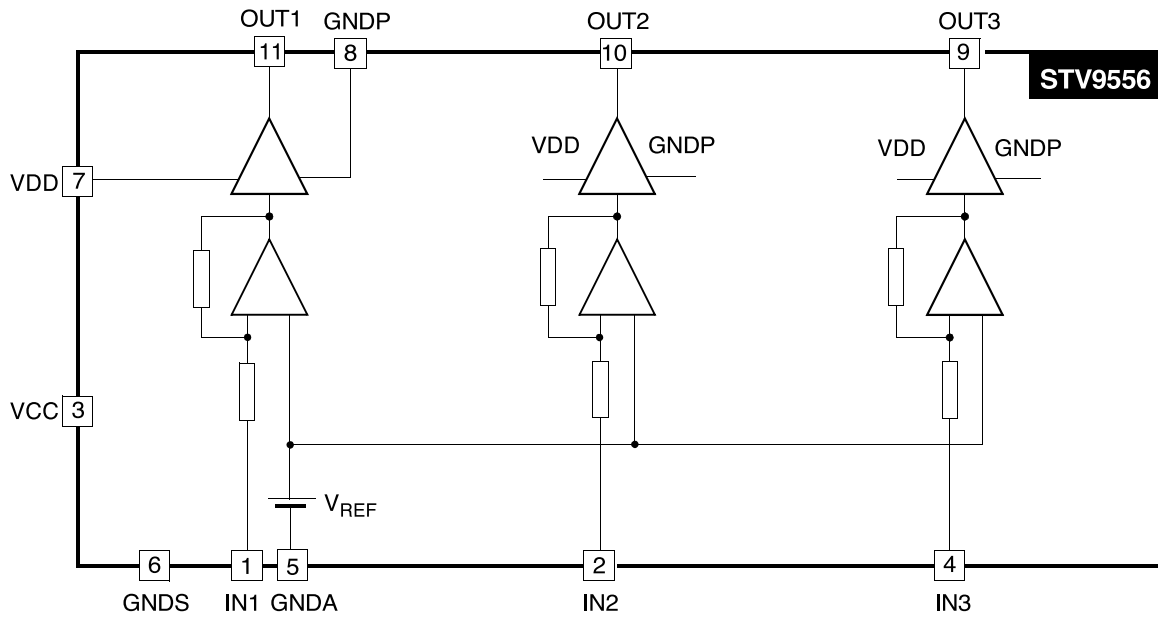

# SCHEMATIC DIAGRAM

----- DDC-SDA    ----- IIC-SDA  
----- DDC-SCL    ----- IIC-SCL

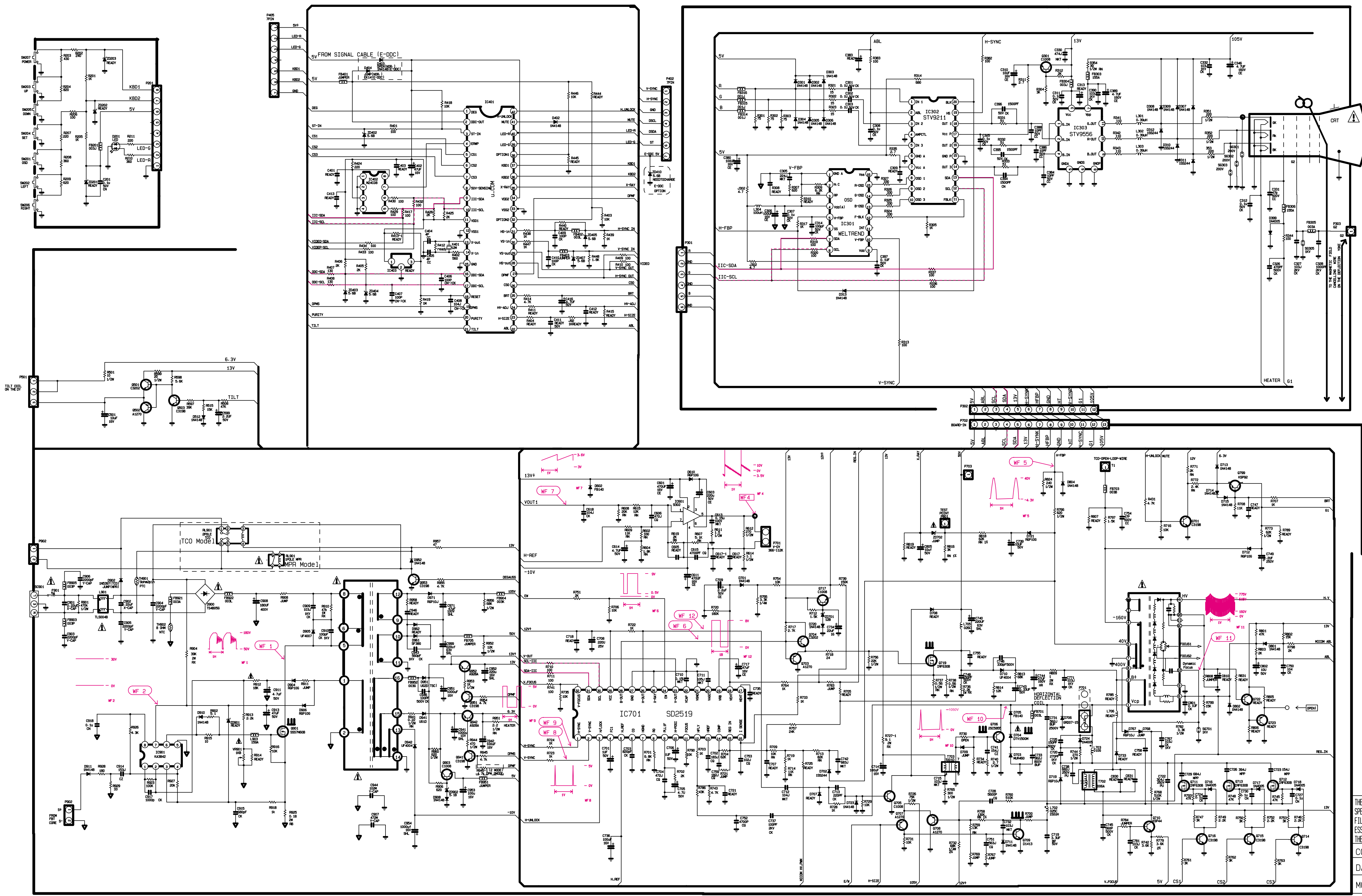

CONDITION 1. 110V  
 2. 60KHZ / 75HZ

THE SYMBOL MARK OF THIS SCHEMATIC DIAGRAM INCORPORATES SPECIAL FEATURES IMPORTANT FOR PROTECTION FROM X-RADIATION, FILTRATION AND ELECTRICAL SHOCK HAZARDS. WHEN SERVICING IT IS ESSENTIAL THAT ONLY MANUFACTURER SPECIFIED PARTS BE USED FOR THE CRITICAL COMPONENTS IN THE SYMBOL MARK OF THE SCHEMATIC.

COMPANY CONFIDENTIAL DO NOT COPY!  
 DATE 2002.08.26    REV 01  
 MODEL CB777H-1enchang Sheet 1 / 1 Page



# PRINTED CIRCUIT BOARD

## 1. MAIN BOARD (Component Side)

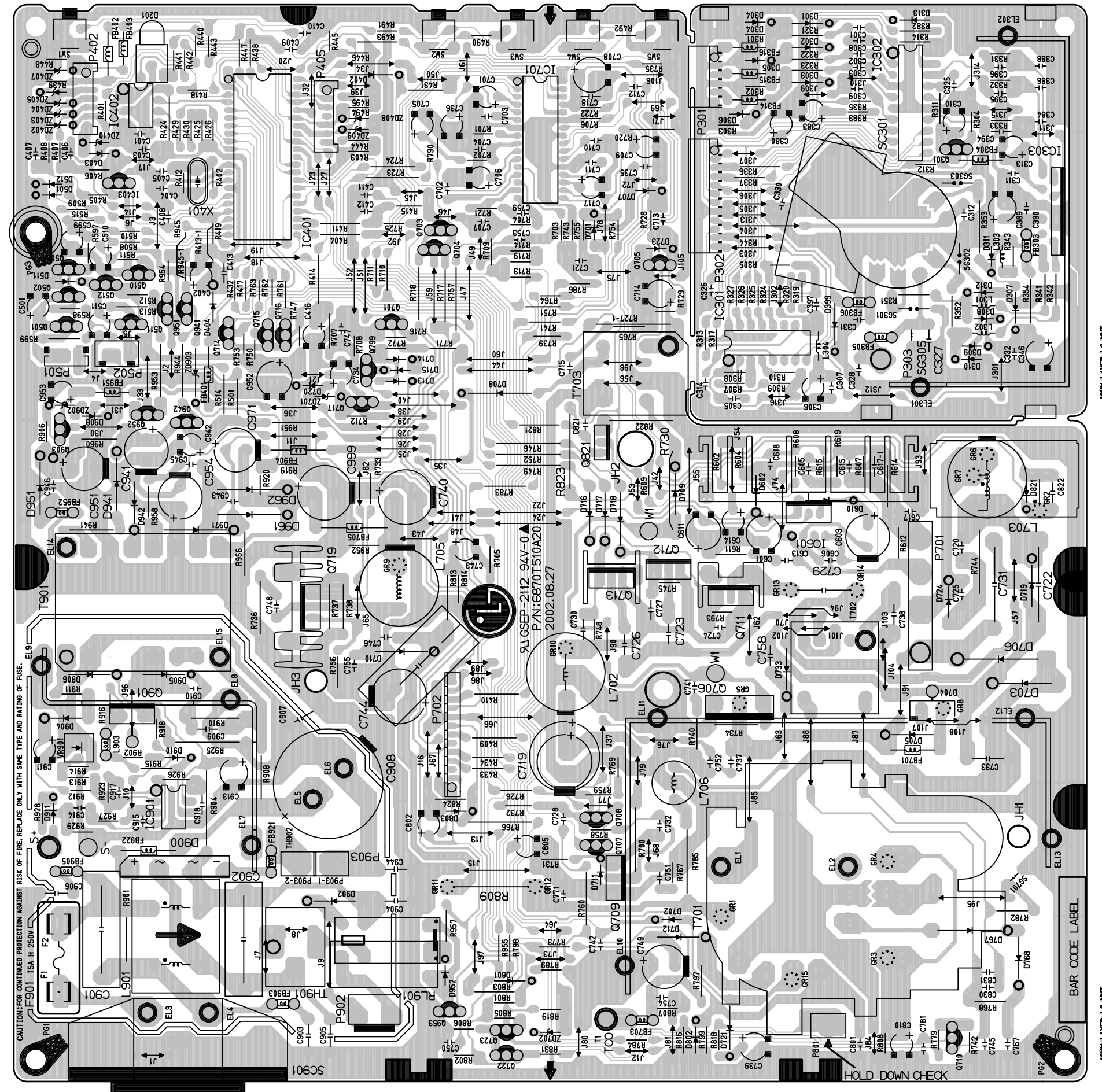

## 2. MAIN BOARD (Solder Side)

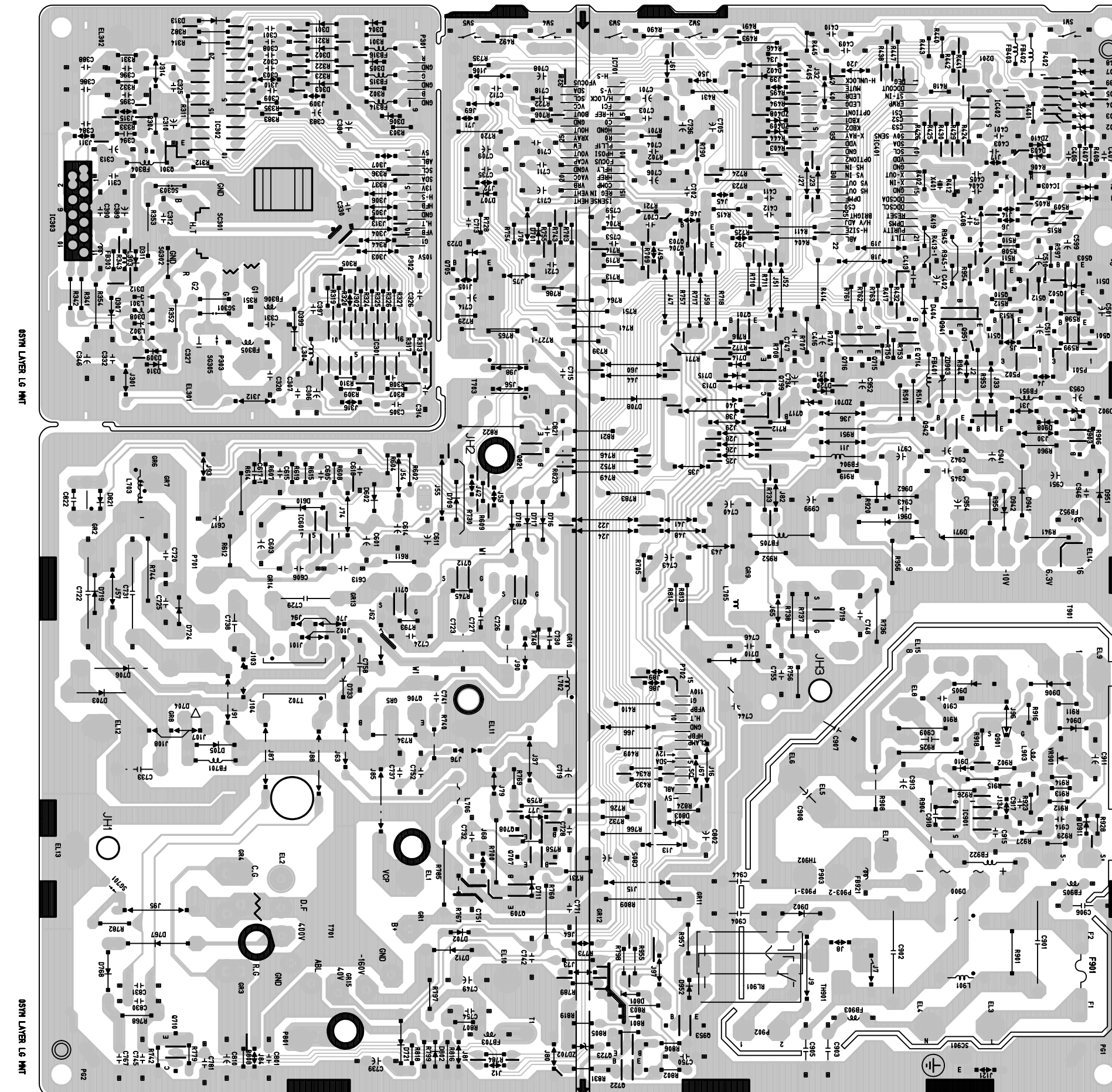



P/NO : 3828TSL091J

Dec. 2002  
Printed in Korea

## Free Manuals Download Website

<http://myh66.com>

<http://usermanuals.us>

<http://www.somanuals.com>

<http://www.4manuals.cc>

<http://www.manual-lib.com>

<http://www.404manual.com>

<http://www.luxmanual.com>

<http://aubethermostatmanual.com>

Golf course search by state

<http://golfingnear.com>

Email search by domain

<http://emailbydomain.com>

Auto manuals search

<http://auto.somanuals.com>

TV manuals search

<http://tv.somanuals.com>