



# DVD RECEIVER OWNER'S MANUAL

MODEL: LHT754

Main Unit - LHT754  
Speakers - SH92SB-S  
SH92SB-C  
SH92SB-W



Before connecting, operating or adjusting this product, please read this instruction booklet carefully and completely.



© Copyright 2007, LG Electronics U.S.A., Inc.



**CAUTION:** TO REDUCE THE RISK OF ELECTRIC SHOCK DO NOT REMOVE COVER (OR BACK) NO USER-SERVICEABLE PARTS INSIDE REFER SERVICING TO QUALIFIED SERVICE PERSONNEL.



This lightning flash with arrowhead symbol within an equilateral triangle is intended to alert the user to the presence of uninsulated dangerous voltage within the product's enclosure that may be of sufficient magnitude to constitute a risk of electric shock to persons.



The exclamation point within an equilateral triangle is intended to alert the user to the presence of important operating and maintenance (servicing) instructions in the literature accompanying the product.

**WARNING:** TO PREVENT FIRE OR ELECTRIC SHOCK HAZARD, DO NOT EXPOSE THIS PRODUCT TO RAIN OR MOISTURE.

**WARNING:** Do not install this equipment in a confined space such as a book case or similar unit.

**CAUTION:** Do not block any ventilation openings. Install in accordance with the manufacturer's instructions.

Slots and openings in the cabinet are provided for ventilation and to ensure reliable operation of the product and to protect it from overheating.

The openings should never be blocked by placing the product on a bed, sofa, rug or other similar surface. This product should not be placed in a built-in installation such as a bookcase or rack unless proper ventilation is provided or the manufacturer's instruction have been adhered to.

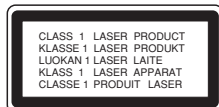

**CAUTION:**

This product employs a Laser System.

To ensure proper use of this product, please read this owner's manual carefully and retain it for future reference. Should the unit require maintenance, contact an authorized service center.

Use of controls, adjustments or the performance of procedures other than those specified herein may result in hazardous radiation exposure.

To prevent direct exposure to laser beam, do not try to open the enclosure. Visible laser radiation when open. DO NOT STARE INTO BEAM.

**CAUTION:** The apparatus should not be exposed to water (dripping or splashing) and no objects filled with liquids, such as vases, should be placed on the apparatus.

**CAUTION concerning the Power Cord**

**Most appliances should be placed on a dedicated circuit;**

That is, a single outlet circuit which powers only that appliance and has no additional outlets or branch circuits. Check the specification page of this owner's manual to be certain.

Do not overload wall outlets. Overloaded wall outlets, loose or damaged wall outlets, extension cords, frayed power cords, or damaged or cracked wire insulation are dangerous. Any of these conditions could result in electric shock or fire. Periodically examine the cord of your appliance, and if its appearance indicates damage or deterioration, unplug it, discontinue use of the appliance, and have the cord replaced with an exact replacement part by an authorized servicer.

Protect the power cord from physical or mechanical abuse, such as being twisted, kinked, pinched, closed in a door, or walked upon. Pay particular attention to plugs, wall outlets, and the point where the cord exits the appliance.

To disconnect power from the unit, unplug the unit from the outlet. When installing the product, ensure that the plug is easily accessible.

**FCC WARNING:** This equipment may generate or use radio frequency energy. Changes or modifications to this equipment may cause harmful interference unless the modifications are expressly approved in the instruction manual. The user could lose the authority to operate this equipment if an unauthorized change or modification is made.

**REGULATORY INFORMATION: FCC Part 15**

This equipment has been tested and found to comply with the limits for a Class B digital device, pursuant to Part 15 of the FCC Rules. These limits are designed to provide reasonable protection against harmful interference when the product is operated in a residential installation. This product generates, uses, and can radiate radio frequency energy and, if not installed and used in accordance with the instruction manual, may cause harmful interference to radio communications. However, there is no guarantee that interference will not occur in a particular installation. If this product does cause harmful interference to radio or television reception, which can be determined by turning the product off and on, the user is encouraged to try to correct the interference by one or more of the following measures:

- Reorient or relocate the receiving antenna.
- Increase the separation between the product and receiver.
- Connect the product into an outlet on a circuit different from that to which the receiver is connected.
- Consult the dealer or an experienced radio/TV technician for help.

**FCC COMPLIANCE:** The responsible party for this product's compliance is:

Marketed and Distributed by LG Electronics U.S.A., Inc.,  
1000 Sylvan Avenue, Englewood Cliffs, NJ.  
Phone: 1-201-816-2000.

## IMPORTANT SAFETY INSTRUCTIONS

**CAUTION: PLEASE READ AND OBSERVE ALL WARNINGS AND INSTRUCTIONS IN THIS OWNER'S MANUAL. AND THOSE MARKED ON THE PRODUCT. RETAIN THIS MANUAL FOR FUTURE REFERENCE.**

This product has been designed and manufactured to assure personal safety. Improper use can result in electric shock or fire hazard. The safeguards incorporated in this product will protect you if you observe the following procedures for installation, use, and servicing.

This product does not contain any parts that can be repaired by the user.

**DO NOT REMOVE THE CABINET COVER, OR YOU MAY BE EXPOSED TO DANGEROUS VOLTAGE. REFER SERVICING TO QUALIFIED SERVICE PERSONNEL ONLY.**

- 1. Read these instructions.** - All these safety and operating instructions should be read before the product is operated.
- 2. Keep these instructions.** - The safety, operating and use instructions should be retained for future reference.
- 3. Heed all warnings.** - All warnings on the product and in the operating instructions should be adhered to.
- 4. Follow all instructions.** - All operating and use instructions should be followed.
- 5. Do not use this apparatus near water.** - For example: near a bath tub, wash bowl, kitchen sink, laundry tub, in a wet basement; or near a swimming pool; and other areas located near water.
- 6. Clean only with dry cloth.** - Unplug this product from the wall outlet before cleaning. Do not use liquid cleaners.
- 7. Do not block any ventilation openings. Install in accordance with the manufacturer's instructions.** - Slots and openings in the cabinet are provided for ventilation and to ensure reliable operation of the product and to protect it from over-heating. The openings should never be blocked by placing the product on a bed, sofa, rug or other similar surface. This product should not be placed in a built-in installation such as a bookcase or rack unless proper ventilation is provided or the manufacturer's instructions have been adhered to.
- 8. Do not install near any heat sources such as radiators, heat registers, stoves, or other apparatus (including amplifiers) that produce heat.**
- 9. Do not defeat the safety purpose of the polarized or grounding-type plug.** A polarized plug has two blades with one wider than the other. A grounding type plug has two blades and a third grounding prong. The wide blade or the third prong are provided for your safety. If the provided plug does not fit into your outlet, consult an electrician for replacement of the obsolete outlet.
- 10. Protect the power cord from being walked on or pinched particularly at plugs, convenience receptacles, and the point where they exit from the apparatus.**
- 11. Only use attachments/accessories specified by the manufacturer.**
- 12. Use only with the cart, stand, tripod, bracket, or table specified by the manufacturer, or sold with the apparatus. When a cart is used, use caution when moving the cart/apparatus combination to avoid injury from tip-over.**
- 13. Unplug this apparatus during lightning storms or when unused for long periods of time.**
- 14. Refer all servicing to qualified service personnel.** Servicing is required when the apparatus has been damaged in any way, such as power-supply cord or plug is damaged, liquid has been spilled or objects have fallen into the apparatus, the apparatus has been exposed to rain or moisture, does not operate normally, or has been dropped.



<b>Introduction</b>	
Maintenance and Service	.4
Before use	.5
Front Panel/Rear Panel	.6
Remote Control	.7

## Installation and Setup

TV Connection	.8
Optional Equipment Connection	.9
USB connection	.9
AUX IN connection	.9
OPTICAL IN connection	.9
AUDIO IN connection	.9
iPod connection	.9
Antenna Connection	.10
Speaker System Connection	.10
HDMI Connection	.11
Displaying Disc Information on-screen	.12
Initial Settings	.12
General Operation	.12-14
LANGUAGE	.12
DISPLAY	.12
AUDIO	.13
5.1 Speaker Setup	.13
LOCK (Parental Control)	.14
OTHERS	.14

## Operation

General features	.15
Additional features	.16
Playing an Audio CD or MP3/WMA file	.17
Programmed Playback	.17
Viewing a JPEG file	.18
Playing a DivX Movie file	.19
Using iPod	.20-21
DVD Audio Discs	.22
Presetting the Radio Stations	.23
Listening to the Radio	.23
Sleep Timer Setting	.24
Dimmer	.24
Mute	.24
Selecting input source	.24
XTS/XTS pro	.24
VIRTUAL sound	.24
Sound Mode	.24
XM Satellite Radio Operation	.25-26
Controlling your TV with the Supplied Remote Control	.27
Controlling other TVs with the Supplied Remote Control	.27-28

## Reference

Language Codes	.29
Area Codes	.29
Troubleshooting	.30-31
Specifications	.32

## Maintenance and Service

Refer to the information in this chapter before contacting a service technician.

### Handling the unit

#### When shipping the unit

Please save the original shipping carton and packing materials. If you need to ship the unit, for maximum protection, re-pack the unit as it was originally packed at the factory.

#### Keeping the exterior surfaces clean

- Do not use volatile liquids such as insecticide spray near the unit.
- Do not leave rubber or plastic products in contact with the unit for a long period of time. since they leave marks on the surface.

#### Cleaning the unit

To clean the player, use a soft, dry cloth. If the surfaces are extremely dirty, use a soft cloth lightly moistened with a mild detergent solution.

Do not use strong solvents such as alcohol, benzene, or thinner, as these might damage the surface of the unit.

#### Maintaining the Unit

The DVD/CD Receiver is a high-tech, precision device. If the optical pick-up lens and disc drive parts are dirty or worn, the picture quality could be diminished.

Depending on the operating environment, regular inspection and maintenance are recommended after every 1,000 hours of use.

For details, please contact your nearest authorized service center.



#### What is SIMPLINK?

Some functions of this unit are controlled by TV's remote control when this unit and LG TV with SIMPLINK are connected through HDMI connection.

- Controllable functions by LG TV's remote control; Play, Pause, Scan, Skip, Stop, Power Off, etc.
- Refer to the TV owner's manual for the details of SIMPLINK function.
- LG TV with SIMPLINK function has the logo as shown above.

# Introduction

## Before use

To ensure proper use of this product, please read this owner's manual carefully and retain it for future reference.

This manual provides information on the operation and maintenance of your DVD/CD Receiver. Should the unit require service, contact an authorized service location.

### About the Symbol Display

" " may appear on your TV display during operation and indicates that the function explained in this owner's manual is not available on that specific DVD video disc.

### Symbol Used in this Manual

#### Note:

Indicates special notes and operating features.

#### Tip:

Indicates tips and hints for making the task easier.



A section whose title has one of the following symbols is applicable only to the disc represented by the symbol.

	DVD
	Audio CDs
	MP3 files
	WMA files
	JPEG files
	DivX files

*Manufactured under license from Dolby Laboratories. "Dolby", "Pro Logic", and the double-D symbol are trademarks of Dolby Laboratories. Confidential Unpublished works. Copyright 1992-1997 Dolby Laboratories. All rights reserved.*

*Manufactured under license from Digital Theater Systems, Inc. U.S. Pat. No's. 5,451,942; 5,956,674; 5,974,380; 5,978,762; 6,226,616; 6,487,535 and other U.S. and world-wide patents issued and pending. "DTS" and "DTS Digital Surround" are registered trademarks of Digital Theater Systems, Inc. Copyright 1996, 2003 Digital Theater Systems, Inc. All Rights Reserved.*

### Types of Playable Discs

	DVD (8 cm / 12 cm disc)
	Audio CD (8 cm / 12 cm disc)

In addition, this unit can play a DVD±R, DVD±RW, and CD-R or CD-RW that contains audio titles, MP3, WMA, JPEG or DivX files.

#### Notes:

- Depending on the conditions of the recording equipment or the CD-R/RW (or DVD-RW, DVD+RW) disc itself, some CD-R/RW (or DVD-RW, DVD+RW) discs may not be played on the unit.
- Do not attach any seal or label to either side (the labeled side or the recorded side) of a disc.
- Do not use irregularly shaped CDs (e.g., heart-shaped or octagonal). It may result in malfunctions.

#### Regional Code

This unit has a regional code printed on the rear of the unit. This unit can play only DVD discs labelled as the same as the rear of the unit or "ALL".

#### Notes on Regional Codes

- Most DVD discs have a globe with one or more numbers in it clearly visible on the cover. This number must match your DVD player's regional code or the disc cannot play.
- If you try to play a DVD with a different regional code from your player, the message "Check Regional Code" appears on the TV screen.



#### Remote Control Operation Range

Point the Remote Control at the Remote Sensor and press the buttons.

- **Distance:** About 23 ft (7 m) from the front of the Remote Sensor
- **Angle:** About 30° in each direction in front of the Remote Sensor

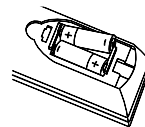
#### Remote Control battery installation



Remove the battery cover on the rear of the Remote Control, and insert two R06 (size AA) batteries with  and  aligned correctly.

## Front Panel/Rear Panel

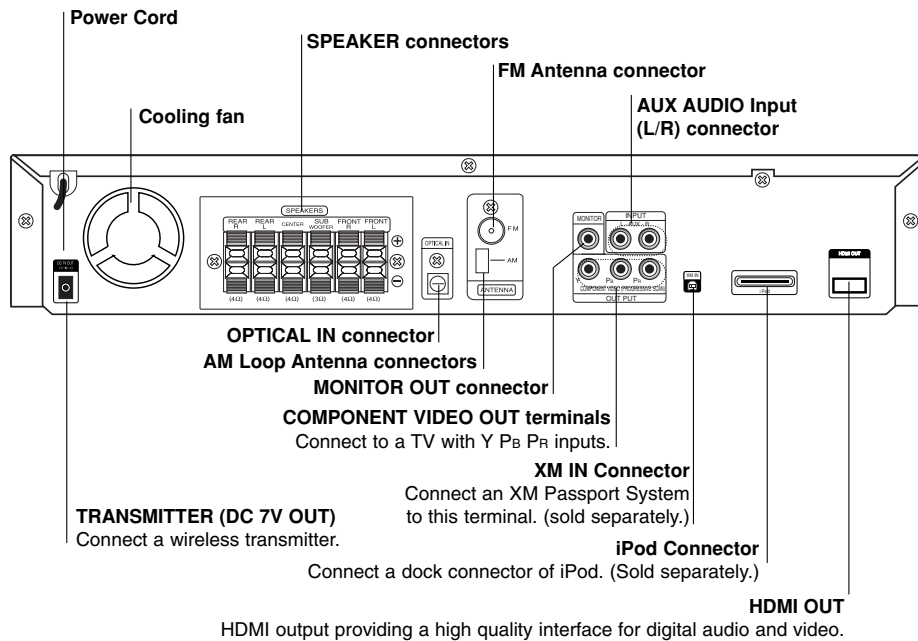
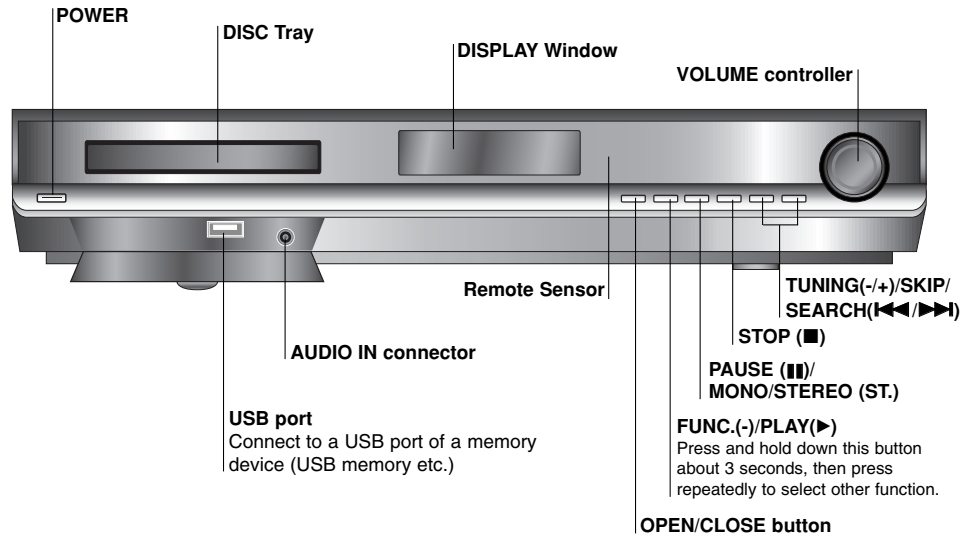

- Do not touch the inner pins of the jacks on the rear panel. Electrostatic discharge may cause permanent damage to the unit.
- Wireless transmitter receiver kit not supplied. We urge you to purchase such a kit to avoid cumbersome wires running front to back on the floor.

## Remote Control

- POWER**  
Selects the System's tuner (FM, AM and XM bands).
- AUX**  
Selects input source.
- USB**  
Plays the multimedia files.
- DIMMER**  
Changes brightness of the display window on the front panel during in power-on status.
- AUDIO**  
Selects an audio language (DVD) or an audio channel (CD).
- SOUND**  
Selects the sound mode.
- REPEAT**  
Repeats chapter, track, title, all
- REPEAT A-B**  
Repeats sequence.
- MENU**  
Accesses the menu on a DVD disc.
- ZOOM**  
Enlarges video image.
- SETUP**  
Accesses or removes setup menu.
- DISPLAY**  
Accesses On-Screen display.
- RETURN**  
Removes the menu.
- ◀/▶/▲/▼ (left/right/up/down)**  
Selects an option in the menu.
- ENTER**  
Acknowledges the menu selection.
- PRESET (-/+)**  
Selects programme of Radio.
- XM CH (-/+)**  
Tunes in the desired XM station.
- TUN. (-/+)**  
Tunes in the desired radio station.
- 0-9 numerical buttons**  
Selects a service, program number directly or selects numbered options in a menu.
- CAT**  
Selects the Category Search.
- HDMI**  
Switches the HDMI mode to HDMI (active) and OFF (inactive).
- OPEN/CLOSE (▲)**  
Opens and closes the disc tray.
- DVD**  
Selects the output source (CD/DVD).
- iPod**  
Selects the iPod source.
- S-TITLE**  
Selects a subtitle language (DVD).
- CLEAR**  
Removes a track number on the program menu or a mark on the MARKER SEARCH menu.
- MARKER**  
Marks a point during playback.
- SEARCH**  
Displays MARKER SEARCH menu.
- SCAN/SLOW(◀◀/▶▶)**  
Searches backward or forward. Reverse/Forward slow playback.
- SKIP (◀◀/▶▶)**  
Moves to the previous or next chapter or track.
- TITLE**  
Displays the disc's Title menu, if available.
- STOP (■), PLAY (▶)**
- PAUSE/STEP (⏸)**
- VSM**  
**XTS pro**  
Supplies more natural and realistic sound. Supplies great sound effect.
- SLEEP**  
Sets the System to turn off automatically at a specified time.
- MUTE**  
Turns the sound on and off temporarily.
- VOLUME (-/+)**  
Adjusts speaker volume.
- XM MODE**  
Selects a XM display mode.
- RESOL.**  
Changes the resolution depending on your TV.
- PROG./MEMO.**  
Accesses or removes Program menu. Enter a radio station's frequency into the tuner.
- TV Control Buttons**
- POWER: Switches TV ON and OFF.
  - CHANNEL ▲/▼: Selects TV's channel.
  - VOLUME +/-: Adjusts TV's volume.
  - INPUT: Selects the TV's source.

# Installation and Setup

## TV Connection

Make one of the following connections, depending on the capabilities of your existing equipment.

### Tips:

- Depending on your TV and other equipment you wish to connect, there are various ways you could connect the DVD/CD Receiver. Use one of the connections described below.
- Please refer to the manuals of your TV, VCR, Stereo System or other devices as necessary to make the best connections.

### Caution:

- Make sure the DVD/CD Receiver is connected directly to the TV. Select the correct AV input on your TV.
- Do not connect your DVD/CD Receiver to the TV via your VCR. The DVD image could be distorted by the copy protection system.

### Rear of DVD/CD Receiver

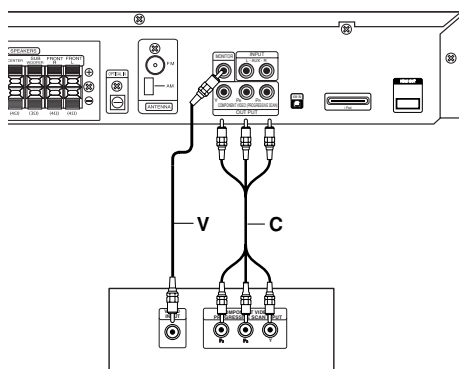

Rear of TV

### Video connection

Connect the MONITOR OUT jack from the DVD/CD Receiver to the VIDEO IN jack on the TV using the video cable supplied (V).

### Component Video (Color Stream®) connection

Connect the COMPONENT VIDEO OUT jacks from the DVD/CD Receiver to the corresponding jacks on the TV using a Y P B cable (C).

- If your television is a high-definition or "digital ready" television, you may take advantage of the DVD/CD Receiver's progressive scan output for the highest video resolution.
- If your TV does not accept your resolution setting, abnormal picture appears on the screen. Please read owner's manual for TV then set the resolution that your TV can accept.

### Note:

The HDMI mode must be set to OFF for VIDEO OUT and Component video connections.



## Optional Equipment Connection

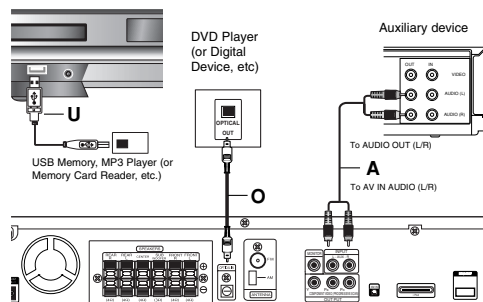

Rear of DVD/CD Receiver

### USB connection (U)

Connect the USB port of USB Memory (or MP3 player, etc.) to the USB port on the front of the unit.

#### Removing the USB Device from the unit

1. Choose a different function mode or press STOP (■) twice in a row.
2. Remove the USB device from the unit.

#### Notes:

- Don't extract the USB device while operating.
- Music files (MP3/WMA), image files (JPEG) and video files can be played.
- This unit cannot use a USB HUB.
- Recommended Memory Cards.  
Compact Flash Card (CFC), Micro Drive (MD), Smart Media Card (SMC), Memory Stick (MS), Secure Digital Card (SD), Multimedia Card (MMC), Memory Stick Pro (MS-Pro)  
- Compatible with: FAT16, FAT32  
- Only use the memory cards recommended.
- Devices which require additional program installation when you have connected the unit to a computer are not supported.
- In case of a USB HDD, make sure to connect an auxiliary power cord to the USB HDD for proper operation. Up to four primary partitions of a drive are supported. If there is an extension partition, it will not be supported.
- If the drive of USB device is two or more, a drive folder is displayed on the screen. If you want to move to the initial menu after you select a folder, press RETURN.
- Digital cameras and mobile phones are not supported.

### AUX IN connection (A)

Connect a Output of auxiliary device to the AUX AUDIO Input (L/R) Connector.

### OPTICAL IN connection (O)

Connect an optical output of DVD Player (or Digital Device etc) to the OPTICAL IN connector.

### AUDIO IN connection (D)

Connect a output of portable device (MP3 or PMP etc) to the AUDIO input connector.

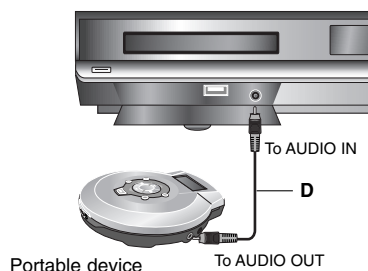

Portable device

### iPod connection

Connect the iPod connector on the rear of the DVD/CD Receiver to the dock connector of iPod using an iPod cable (I).

#### Rear of DVD/CD Receiver

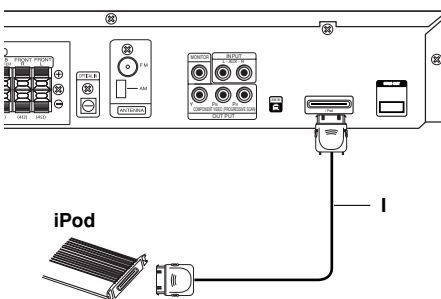

#### Notes:

- Depending on the type of iPod, you may need to insert one of the dock adapters into the dock slot before you station your iPod.
- Adjust the volume to a moderate level before you connect your iPod and this unit.

## Antenna Connection

Connect the supplied FM/AM antenna for listening to the radio.

- Connect the AM Loop antenna to the AM antenna connector.
- Connect the FM Wire antenna to the FM antenna connector.

### Notes:

- To prevent noise pickup, keep the AM Loop antenna away from the DVD/CD Receiver and other components.
- Be sure to fully extend the FM wire antenna.
- After connecting the FM Wire antenna, keep it as horizontal as possible.

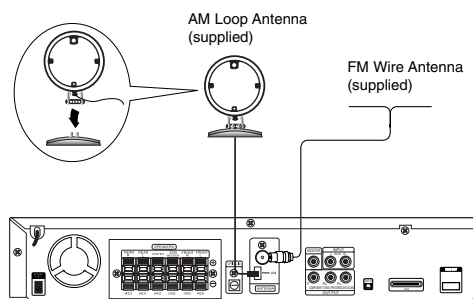

## Speaker System Connection

Connect the speakers using the supplied speaker wires.

To obtain the best possible surround sound, adjust the speaker parameters (volume, distance, etc.).

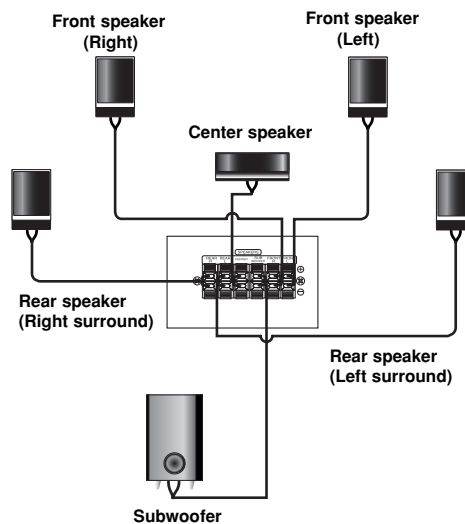

### Notes:

- Be sure to match the speaker wire to the appropriate terminal on the components: + to + and - to -. If the cables are reversed, the sound will be distorted and will lack bass.
- If you use front speakers with low maximum input rating, adjust the volume carefully to avoid excessive output on the speakers.

## HDMI Connection

### About HDMI

HDMI (High Definition Multimedia Interface) supports both video and audio on a single digital connection for an easy all-digital output to an HDMI or DI-equipped TV.

Connection to an HDMI TV requires an HDMI cable while connection to a DVI-equipped TV requires a DVI adapter besides a HDMI cable.

HDMI has the capability to support standard, enhanced, or high-definition video plus standard to multi-channel surround-sound audio. HDMI features include uncompressed digital video, a bandwidth of up to 5 gigabytes per second, one connector (instead of several cables and connector), and communication between the AV source and AV devices such as DTVs.

*HDMI, the HDMI logo and High-Definition Multimedia Interface are trademarks or registered trademarks of HDMI licensing LLC.*

**If you have a HDMI TV or monitor, you can connect it to this DVD/CD Receiver using a HDMI cable.**

1. Connect the HDMI OUT jack on the DVD/CD Receiver to the HDMI jack on a HDMI compatible TV or monitor (H).
2. Set the TV's source to HDMI (refer to owner's manual for TV).
3. In the stop mode, select HDMI mode by pressing HDMI. Press RESOL. repeatedly to select the resolution you wish to change.

### Notes:

- The arrow on the cable connector body should face up for correct alignment with the connector on the DVD/CD Receiver.
- If HDMI cable is not connected, the HDMI button does not operate.
- If there is noise or there are lines on the screen, please check the HDMI cable.
- Not all HDCP-compatible DVI devices will work with this DVD/CD Receiver.
- If TV does not support HDCP, snow noise appears on the screen, or picture may be vibrated.

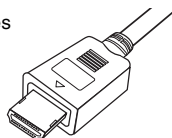

### Tip :

When you use HDMI connection, you can change the resolution (480p, 720p, 1080i) for the HDMI output by pressing RESOL. on the Remote Control.

### Important Note

If you turn off the TV or disconnect the HDMI cable during playback of the device, playback will pause.

**You have to click on the play button to play back again.**

For some TVs, when you change the TV mode, such condition specified above may happen.

### Rear of DVD/CD Receiver

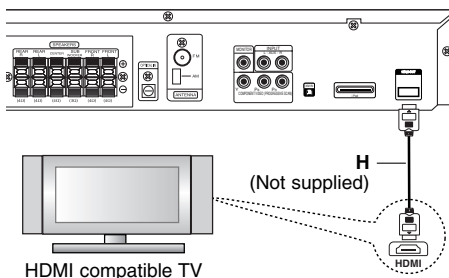

### Resolution setting

You can change the resolution for the COMPONENT VIDEO OUT by pressing RESOL. on the Remote Control. Available resolution settings are as shown below.

OUTPUT CONNECTION	Available Resolution
HDMI VIDEO OUT	920 x 1080i 1280 x 720p 720 x 480p
COMPONENT VIDEO OUT	1920 x 1080i 1280 x 720p 720 x 480p 720 x 480i
MONITOR OUT	720 x 480i

### Notes:

- If the picture does not appear on the screen with the analog video connections, change the resolution to 480i.
- For 720p and 1080i resolution on the component video out, only non-copy protected discs can be played back. If the disc is copy protected, it will be displayed at the 480p resolution.
- 1080i, 720p, and 480p does not work with the analog video connections (MONITOR OUT).
- The component (Y/P<sub>B</sub>/P<sub>R</sub>) will output to black picture in the RGB mode.
- If you change the resolution, the display MENU (MP3/JPEG/DivX) size is changed.
- If your TV does not accept your resolution setting, abnormal picture appears on the screen. Please read owner's manual for TV, and then set the resolution that your TV can accept.

### Caution:

Changing the resolution when the DVD/CD Receiver is connected with HDMI connector may result in malfunctions. To solve the problem, turn off the DVD/CD Receiver and then turn it on again.

## Displaying Disc Information On - screen

You can display various information about the disc loaded on-screen.

1. Press DISPLAY to show various playback information.  
The displayed items differ depending on the disc type or playing status.
2. You can select an item by pressing ▲ / ▼ and change or select the setting by pressing ◀ / ▶.
  - Title (Track) – Current title (or track) number/ total number of titles (or tracks).
  - Chapter – Current chapter number/total number of chapters.
  - Time – Elapsed playing time.
  - Audio – Selected audio language or channel.
  - Subtitle – Selected subtitle.
  - Angle – Selected angle/total number of angles.
  - Sound – Selected sound mode.

### Note:

If any button is not pressed for a few seconds, the on-screen display disappears.

## Initial Settings

By using the Setup menu, you can make various adjustments to items such as picture and sound. You can also set a language for the subtitles and the Setup menu, among other things. For details on each Setup menu item, see the pages 12 to 14.

### To display and exit the Menu:

Press SETUP to display the menu. A second press of SETUP will take you back to initial screen.

### To go to the next level:

Press ▶ on the Remote Control.

### To go back to the previous level:

Press ◀ on the Remote Control.

## GENERAL OPERATION

1. Press SETUP. The Setup menu appears.
2. Use ▲ / ▼ to select the desired option then press ▶ to move to the second level. The screen shows the current setting for the selected item, as well as alternate setting(s).
3. Use ▲ / ▼ to select the second desired option and then press ▶ to move to the third level.
4. Use ▲ / ▼ to select the desired setting then press ENTER to confirm your selection. Some items require additional steps.
5. Press SETUP or PLAY to exit the Setup menu.

## LANGUAGE

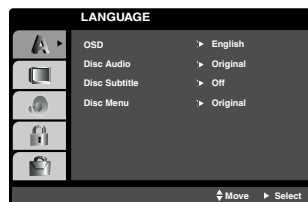

### OSD

Select a language for the Setup menu and then on-screen display.

### Disc Audio / Subtitle / Menu

Select the language you prefer for the audio track (disc audio), subtitles, and the disc menu.

**Original** – Refers to the original language in which the disc was recorded.

**Other** – To select another language, press numeric buttons and then ENTER to enter the corresponding 4-digit number according to the language code list on the page 29. If you enter the wrong language code, press CLEAR.

## DISPLAY

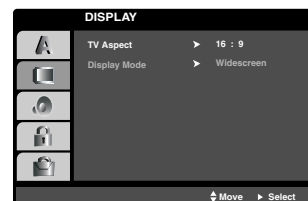

### TV Aspect

**4:3** – Select when a standard 4:3 TV is connected.

**16:9** – Select when a 16:9 wide TV is connected.

### Display Mode

The display Mode setting works only when the TV Aspect mode is set to "4:3".

**Letterbox** – Displays a wide picture with bands on the upper and lower portions of the screen.

**Panscan** – Automatically displays the wide picture on the entire screen and cuts off the portions that do not fit.

## AUDIO

Each DVD disc has a variety of audio output options. Set the receiver's AUDIO options according to the type of audio system you use.

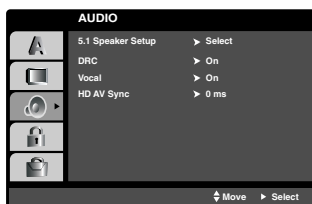

### Dynamic Range Control (DRC)

With the DVD\*1 format, you can hear a program's soundtrack in the most accurate and realistic presentation, thanks to digital audio technology. However, you may wish to compress the dynamic range of the audio output (the difference between the loudest sounds and the quietest ones). Then, you may listen to a movie at a lower volume without losing clarity of sound. Set DRC to On for this effect.  
\*1: Dolby Digital only

### Vocal

Set Vocal to On only when a multi-channel karaoke DVD is playing. The karaoke channels on the disc will mix into normal stereo sound.

### HD AV Sync

When using Digital TV.

Sometimes AV signal could not be transmitted simultaneously because of later transmission of video signal compared to audio signal.

Because it takes some time to convert analog video signal to digital one in the Digital TV.

And It means that you may not enjoy picture on the screen and sound from speaker at the same time even though it is one scene.

In the HD AV Sync menu, you could adjust delay time to audio signal for simultaneous AV signal transmission

- Delay time could be set up with 10msec unit. (0 ~ 300ms)
- Delay time is different according to each TV Brand. So you need to adjust optimal delay time complying with your TV.

## 5.1 Speaker Setup

Make the following settings for the built-in 5.1 channel surround decoder.

1. Press ENTER, and the 5.1 Speaker Setup menu appears.

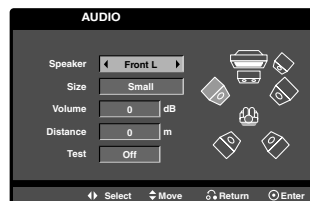

2. Use ◀ / ▶ to select the desired speaker.
3. Adjust options using ▲ / ▼ / ◀ / ▶ buttons.
4. Press ENTER to confirm your selection. Returns to the previous menu.

### Speaker selection

Select a speaker that you want to adjust. [Front speaker (Front L), Front speaker (Front R), Center Speaker (Center), Subwoofer (SubWoofer), Rear speaker (Rear L), Rear speaker (Rear R)]

### Note:

Certain speaker settings are prohibited by the Dolby Digital licensing agreement.

### Size

Since the speaker settings are fixed, you cannot change the settings.

### Volume

Press ◀ / ▶ to adjust the output level of the selected speaker. (-5dB ~ 5dB)

### Distance

If you connected speakers to your DVD/CD Receiver, setting the Distance lets the speakers know how far the sound has to travel to reach your set listening point. This allows the sound from each speaker to reach the listener at the same time.

Press ◀ / ▶ to adjust the Distance of the selected speaker. (You can't adjust front / Woofer speakers)

### Test

Press ◀ / ▶ to test the signals of each speaker. Adjust the volume to match the volume of test signals memorized in the system.

Front Left (Front L) → Center → Front Right (Front R)  
→ Rear Right (Rear R) → Rear Left (Rear L) → SubWoofer

## LOCK (Parental Control)



### Rating

Blocks playback of rated DVDs based on their contents. Not all discs are rated.

1. Select "Rating" on the LOCK menu then press ►.
2. To access the LOCK options, you must input the password you have created. If you have not yet entered password, you are prompted to do so. Input a password and press ENTER. Enter it again and press ENTER to verify. If you make a mistake before pressing ENTER, press CLEAR.
3. Select a rating from 1 to 8 using the ▲ / ▼ buttons.  
**Rating 1-8:** Rating one (1) has the most restrictions and rating eight (8) is the least restrictive.  
**Unlock:** If you select unlock, parental control is not active and the disc plays in full.
4. Press ENTER to confirm your rating selection, then press SETUP to exit the menu.

### Password

You can enter or change password.

1. Select Password on the LOCK menu and then press ►.
2. Follow the step 2 as shown above (Rating). To change the password, press ENTER when the "Change" option is highlighted. Input a password and press ENTER. Enter it again and press ENTER to verify.
3. Press SETUP to exit the menu.

### **If you forget your password**

If you forget your password, you can clear it using the following steps:

1. Press SETUP to display the Setup menu.
2. Input the 6-digit number "210499" and press ENTER. The password is cleared.

### Area Code

Enter the code of the area whose standards were used to rate the DVD video disc, based on the list on page 29.

1. Select "Area Code" on the LOCK menu then press ►.
2. Follow step 2 as shown in the rating section.
3. Select the first character using ▲ / ▼ buttons.
4. Press ► and select the second character using ▲ / ▼ buttons.
5. Press ENTER to confirm your Area code selection.

## OTHERS

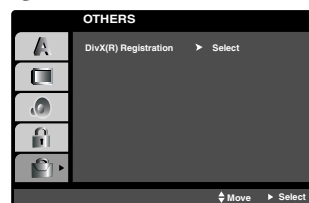

### DivX(R) Registration

We provide you the DivX® VOD (Video On Demand) registration code that allows you to rent and purchase videos based on the DivX® VOD service. For more information, visit [www.divx.com/vod](http://www.divx.com/vod).

1. Select "DivX(R) Registration" option and then press ►.
2. Press ENTER while "Select" is selected and the registration code will appear. Use the registration code to purchase or rent the videos from DivX® VOD service at [www.divx.com/vod](http://www.divx.com/vod). Follow the instructions and download the video onto a disc for playback on this unit.
3. Press ENTER to exit.

### **Note:**

All the downloaded videos from DivX® VOD can only be played back on this unit.

# Operation

## General features

Buttons	Operations	Discs
▲ (OPEN / CLOSE)	Opens or closes the disc tray.	ALL
⏸ (PAUSE)	During playback, press ⏸ to pause playback. Press ⏸ repeatedly to play Frame-by-Frame.	ALL DVD DivX
SKIP (⏮ / ⏭)	During playback, press SKIP (⏮ or ⏭) to go to the next chapter/track or to return to the beginning of the current chapter/track. Press SKIP ⏮ twice briefly to step back to the previous chapter/track.	ALL
SCAN (⏪ / ⏩)	During playback, press SCAN (⏪ or ⏩) repeatedly to select the required scan speed. DVD : ⏪, ⏪⏪, ⏪⏪⏪, ⏪⏪⏪⏪, ⏪⏪⏪⏪⏪ or ▶▶, ▶▶▶, ▶▶▶▶, ▶▶▶▶▶, ▶▶▶▶▶▶ DivX disc : ⏪, ⏪⏪, ⏪⏪⏪, ⏪⏪⏪⏪ or ▶▶, ▶▶▶, ▶▶▶▶, ▶▶▶▶▶ WMA/MP3, Audio CD : ⏪ (X2, X4, X8) or ▶▶ (X2, X4, X8)	DVD DivX ACD MP3 WMA
REPEAT	During playback, press REPEAT repeatedly to select a desired repeat mode. DVD Video discs: Chapter/Title/Off Audio CD, DivX/MP3/WMA discs: Track/All/Off	ALL
REPEAT A-B	During playback, press REPEAT A-B to select a point A and a point B and repeats a sequence from point A (Starting point) to point B (End point). Press REPEAT A-B to exit.	DVD
ZOOM	During playback or in the pause mode, press ZOOM to enlarge the video image (3 steps). You can move through the zoomed picture using ◀▶▲▼ buttons.	DVD
TITLE	If the current DVD title has a menu, the title menu appears on the screen. Otherwise, the disc menu may appear.	DVD
MENU	The disc menu appears on the screen.	DVD
⌨ (SUBTITLE)	During playback, press S-TITLE repeatedly to select a desired subtitle language.	DVD DivX
🔊 (AUDIO language)	During playback, press AUDIO repeatedly to hear a different audio language or audio track.	DVD DivX
SLOW	In the pause mode, press SCAN (⏪ or ⏩) to select the required speed. DVD : ◀ (1/2, 1/4, 1/8, 1/16) or ▶ (1/2, 1/4, 1/8, 1/16)	DVD

### Notes on general features:

- Zoom may not work on some DVDs.
- The A-B repeat function is available only in the current title.

## Additional features

### 1.5 times speed playback

**DVD ACD MP3 WMA**

You can play at 1.5 times speed. The 1.5 speed allows you to watch the pictures and listen to the sound quicker than playing at a normal speed on the disc.

1. During playback, press PLAY(▶) to play at 1.5 times speed. "▶X1.5" appears on the screen.
2. Press PLAY(▶) again to exit.

### Time Search **DVD DivX**

To start playing at any chosen time on the disc:

1. Press DISPLAY during playback.
2. Press ▲ / ▼ to select the time clock icon and "--:--:--" appears.
3. Input the required start time in hours, minutes, and seconds from left to right. If you enter the wrong numbers, press CLEAR to remove the numbers you entered. Then input the correct numbers.
4. Press ENTER to confirm. Playback starts from the selected time.

### Marker Search **DVD DivX**

#### To enter a Marker

You can start playback from up to nine memorized points. To enter a marker, press MARKER at the desired point on the disc. The Marker icon appears on the TV screen briefly. Repeat to enter up to nine markers.

#### To Recall or Clear a Marked Scene

1. During disc playback, press SEARCH. The marker search menu appears on the screen.
2. Within 10 seconds, press ◀ / ▶ to select a marker number that you want to recall or clear.
3. Press ENTER and playback starts from the marked scene. Or press CLEAR and the marker number is erased from the list.
4. You can play any marker by inputting its number on the marker search menu.

### Screen Saver

The screen saver appears when you leave the unit in Stop mode for about five minutes.

### Last Scene Memory **DVD**

This receiver memorizes the last scene from the last disc that is viewed. The last scene remains in the memory even if you remove the disc from the receiver or switch off the receiver. If you load a disc that has the scene memorized, the scene is automatically recalled.

#### Note:

This receiver does not memorize the scene of a disc if you switch off the receiver before commencing to play the disc.



## Playing an Audio CD or MP3/WMA file

This unit can play Audio CDs or MP3/WMA files.

### MP3/ WMA/ Audio CD

Once you insert a CD with MP3/WMA files or Audio, a menu appears on the TV screen.

Press ▲ / ▼ to select a track/file and then press PLAY or ENTER, and playback starts. You can use variable playback functions. Refer to the page 15.

### ID3 TAG

When playing a file containing information such as track titles, you can see the information by pressing DISPLAY. (Song, Artist, Album, Genre, Comment)

### Tips:

- Press MENU to move to the next page.
- On a CD with MP3/WMA and JPEG, you can switch MP3/WMA and JPEG. Press TITLE, and MUSIC or PHOTO top of the menu is highlighted.

### MP3 / WMA disc compatibility with this player is limited as follows:

- Sampling frequency: within 32 - 48 kHz (MP3), within 24 - 48kHz (WMA)
- Bit rate: within 32 - 320kbps (MP3), 40 - 192kbps (WMA)
- The DVD/CD Receiver cannot read an MP3/WMA file that has a file extension other than ".mp3" / ".wma".
- CD-R physical format should be ISO 9660
- If you record MP3 / WMA files using software that cannot create a file system (eg. Direct-CD) it is impossible to playback MP3 / WMA files. We recommend that you use Easy-CD Creator, which creates an ISO 9660 file system.
- File names should have a maximum of 8 letters and must incorporate an .mp3 or .wma extension.
- They should not contain special letters such as / ? \* : " < > | etc.
- The total number of files on the disc should be less than 999.

This DVD/CD Receiver requires discs and recordings to meet certain technical standards in order to achieve optimal playback quality. Pre-recorded DVDs are automatically set to these standards. There are many different types of recordable disc formats (including CD-R containing MP3 or WMA files) and these require certain pre-existing conditions (see above) to ensure compatible playback.

**Customers should note that permission is required in order to download MP3 / WMA files and music from the Internet. Our company has no right to grant such permission. Permission should always be sought from the copyright owner.**

## Programmed Playback

The program function enables you to store your favorite tracks from any disc in the receiver memory. A program can contain 300 tracks.

1. Insert a disc.  
Audio CD and MP3/WMA Discs:
2. Select a track on the "List" and then press PROG. or select "➕" (Add)" icon and then press ENTER to place the selected track on the "Program" list. Repeat to place additional tracks on the list.

### Note:

You can add all tracks in the disc. Select "➕" (Add All)" icon then press ENTER.

3. Select the track you want to start playing on the "Program" list. Press MENU to move to the next page.
4. Press PLAY or ENTER to start. Playback begins in the order in which you programmed the tracks. Playback stops after all of the tracks on the "Program" list have played once.
5. To resume normal playback from programmed playback, select a track of AUDIO CD (or MP3/WMA) list and then press PLAY.

### Repeat Programmed Tracks

1. Press REPEAT when playing a disc. The repeat icon appears.
2. Press REPEAT to select a desired repeat mode.
  - TRACK: repeats the current track
  - ALL: repeats all the tracks on programmed list.
  - Off (No display): does not play repeatedly.

### Erasing a Track from "Program" List

1. Use ▲ ▼ to select the track that you wish to erase from the Program list.
2. Press CLEAR. Alternatively, select "⊖" (Delete)" icon then press ENTER to place the selected track on the Program list. Repeat to erase additional tracks on the list.

### Erasing the Complete Program List

Use ▲ / ▼ to select "⊖" (Del all)" and then press ENTER.

### Note:

The programs are also cleared when the disc is removed.

## Viewing a JPEG file **JPEG**

This unit can play discs with JPEG files.

Before playing JPEG recordings, read the notes on JPEG Recordings on the right.

1. Insert a disc and close the tray.  
The PHOTO menu appears on the TV screen.

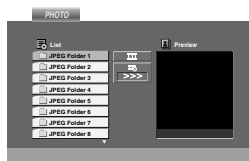

2. Press ▲ / ▼ to select a folder, and then press ENTER. A list of files in the folder appears.  
If you are in a file list and want to return to the previous Folder list, use the ▲ / ▼ buttons on the Remote Control to highlight and press ENTER.
3. If you want to view a particular file, press ▲ / ▼ to highlight a file and press ENTER or PLAY. While viewing a file, you can press STOP to move to the previous menu (JPEG menu).

### **Note:**

When viewing a JPEG file, the resolution is changed 480p if the resolution set to 1080i. You can change the resolution for 720p or 480p.

### **Tips:**

- There are four Slide Speed options :  
> (Slow), >> (Normal), >>> (Fast) and II (off).  
Use ▲ / ▼ / ◀ / ▶ to highlight the Speed. Then, use ◀ / ▶ to select the option you want to use and then press ENTER.
- If you set Speed option to Off, the slide is not active.

### **Slide Show**

Use ▲ ▼ ◀ ▶ to highlight the (Slide Show) then press ENTER.

### **Still Picture**

1. Press PAUSE/STEP during the slide show.  
The DVD/CD Receiver will now go into the PAUSE mode.
2. To return to the slide show, press PLAY or press PAUSE/STEP again.

### **Moving to another File**

Press SKIP (◀◀ or ▶▶) once during viewing a picture to advance to the next or previous file.

### **Rotating the picture**

Press ▲ ▼ ◀ ▶ during showing a picture to rotate the picture clockwise or counter-clockwise.

### **JPEG disc compatibility with this player is limited as follows:**

- Depending upon the size and the number of JPEG files, it could take a long time for the DVD/CD Receiver to read the disc's contents. If you don't see an on-screen display after several minutes, some of the files may be too large — reduce the resolution of the JPEG files to less than 2M pixels as 2760 x 2048 pixels and burn another disc.
- The total number of files and folders on the disc should be less than 999.
- Some discs may not operate due to a different recording format or the condition of disc.
- Ensure that all the selected files have the ".jpg" extensions when copying into the CD layout.
- If the files have ".jpe" or ".jpeg" extensions, please rename them as ".jpg" file.
- File names without ".jpg" extension will not be able to be read by this DVD/CD Receiver. Even though the files are shown as JPEG image files in Windows Explorer.

## Playing a DivX Movie file

Using this DVD/CD Receiver you can play DivX disc.

1. Insert a disc and close the tray. The MOVIE menu appears on the TV screen.

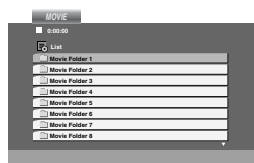

2. Press ▲ / ▼ to select a folder and then press ENTER. A list of files in the folder appears. If you are in a file list and want to return to the Folder list, use the ▲ / ▼ buttons on the Remote Control to highlight  and press ENTER.
3. If you want to view a particular file, press ▲ / ▼ to highlight a file and press ENTER or PLAY.
4. Press STOP to exit.

### Notice for displaying the Divx subtitle

If the subtitle does not display properly during playback, press and hold S-TITLE for about 3 seconds then press S-TITLE to select another language code until the subtitle is displayed properly

### Tips:

- Press MENU to move to the next page.
- On a CD with MP3/WMA, JPEG and MOVIE file, you can switch MUSIC, PHOTO and MOVIE menu. Press TITLE, and MUSIC, PHOTO and MOVIE word on top of the menu is highlighted.

### Notes:

- Be sure to select "SUBTITLE ON" mode by pressing the subtitle file every time before playing a DivX file .
- When the subtitle has more than two languages in the file, original subtitle is only available.
- You can not adjust sound mode and VIRTUAL sound during the DivX file playing.

### DivX disc compatibility with this player is limited as follows:

- Available resolution size of the DivX file is under 800x600 (W x H) pixel.
- The file name of the DivX subtitle is available by 45 characters.
- If there is impossible code to express in the DivX file, it may be displayed as " \_ " mark on the display.
- If the number of the screen frame is over 30 per 1 second, this unit may not operate normally.
- If the video and audio structure of recorded files are not interleaved, either video or audio is outputted.

### Playable DivX file

- ".avi ", ".mpg ", ".mpeg ", ".divx"

### Playable Subtitle format

- SubRip(\*.srt/\* .txt)
- SAMI(\*.smi)
- SubStation Alpha(\*.ssa/\* .txt)
- MicroDVD(\*.sub/\* .txt)
- SubViewer 2.0(\*.sub/\* .txt)
- VobSub(\*.sub)

### Playable Codec format

- "DIVX3.xx ", "DIVX4.xx ", "DIVX5.xx ", "MP43 ", "3IVX "

### Playable Audio format

- "AC3 ", "DTS ", "PCM ", "MP3 ", "WMA "
- Sampling frequency: within 32 - 48 kHz (MP3), within 24 - 48kHz (WMA)
- Bit rate: within 32 - 320kbps (MP3), 40 - 192kbps (WMA)

## Using iPod

You can enjoy playback of your iPod using the supplied remote control.

iPod is a trademark of Apple Computer, Inc, registered in the U.S. and other countries.

### General operation

1. Connect your iPod and the unit with iPod cable. Refer to the page 13.
2. Turn the unit on.  
Your iPod is automatically turned on.
3. Press iPod on the remote control to enter the iPod mode.  
The iPod menu appears on the TV screen.  
The initial screen of iPod menu is the OSD iPod mode.
4. Use ▲ / ▼ and ENTER on the Remote Control to display the list of menu.
5. Press ENTER to play.

### General features

Remote Control buttons	iPod buttons	Operations
▶ (PLAY)	▶	During pause, press ▶ to resume playback.
(PAUSE)	▶	During playback, press    to pause playback.
■ (STOP)	-	During playback, press ■ to stop playback. Press ENTER to resume playback.
SKIP (I◀◀/▶▶I)	I◀◀/▶▶I	During playback, press SKIP (I◀◀ or ▶▶I) to go to the next track or to return to the beginning of the current track. Press SKIP I◀◀ twice briefly to step back to the previous track. Music file: During playback, press and hold SCAN (◀◀ or ▶▶) and then release at a point you want. Video file: During playback, press and hold SKIP (I◀◀ or ▶▶I) and then release at a point you want.
REPEAT	REPEAT	During playback, press REPEAT repeatedly to select a desired repeat mode. (Track/All/Off)
MENU	MENU	Moves to the previous menu.

### Notes:

- It works with all iPod models that have a dock connector.
- Compatibility with your iPod may vary depending on the type of your iPod.
- Depending on your iPod's software version, it may not be possible to control your iPod from the unit. We recommend installing the latest software version.
- Adjust the volume to a moderate level before you connect your iPod and this unit.

### Playing the iPod in the Remote iPod mode

You can operate your iPod by using the supplied remote control and controls on your iPod.

1. Press iPod on the Remote Control until "IPOD" appears in the display window.

### Note:

You can select the Remote iPod mode or OSD iPod mode by pressing repeatedly iPod on the remote control.

2. Use ▲ / ▼ and ENTER on the Remote Control or controls on your iPod to display the list of menu by viewing your iPod.
3. Press ENTER to play.

### Notes:

- When you connect the unit and TV to MONITOR IN/OUT, TV screen is turned off temporarily.
- Connect the MONITOR OUT jack on the rear of the unit to the VIDEO IN jack on the TV using the video cable if you want to view the video or photo file.  
The images of video or photo files are outputted only when you connect the unit to the MONITOR OUT connector.

### Playing the iPod in the OSD iPod mode

You can operate your iPod by controlling OSD menu on the TV screen with the supplied remote control. The controls on your iPod are not operational in the OSD iPod mode.

1. Press iPod on the Remote Control until "OSD IPOD" appears in the display window.
2. Use ▲ / ▼ and ENTER on the Remote Control to display the list of menu.
3. Press ENTER to play.



#### Music

Classifies and plays the files by Playlists, Artists, Albums, Genres, Songs, and Composers.

#### Photos / Videos

The video or photo file is not played in the OSD iPod mode.

If you want to play the video or photo file, change to the Remote iPod mode.

#### Now Playing

Displays and plays the last played music file.

### iPod message



When you connect the unit and TV to COMPONENT VIDEO IN/OUT or HDMI IN/OUT in the Remote iPod mode, the screen on the left appears. Connect the unit and TV to MONITOR IN/OUT.



When you select the Photos or Videos menu in the OSD iPod mode, the screen on the left appears. Change the unit to the Remote iPod mode.



When you connect the iPod that is not supported on this unit, the screen on the left appears.



If the power of your iPod is insufficient or the iPod is misconnected or unknown device, the screen on the left appears.

## DVD Audio Discs

DVD Audio is a new disc format building on the success of DVD to provide high quality, uncompressed, multi-channel audio for a new experience in audio quality. A DVD Audio disc can be identified by the DVD audio logo on the disc jacket or on the disc itself.

DVD Audio can provide higher quality stereo than Audio CDs with a sampling rate of up to 192kHz (compared to 44.1kHz for CDs). DVD Audio digital sound can be delivered with up to 24 bits of data (compared to 16 bits for a standard CD).

A typical DVD Audio disc contains up to seven times the data capacity of a CD. This additional space is used for music, either Advanced Resolution multi-channel sound quality that is closer to the artist's master recording or for longer recordings. Many DVD Audio discs contain on-screen text, such as artist biographies, playlists, or lyrics. Some DVD Audio discs contain photo galleries or video clips.

### **Note:**

To enjoy maximum sound quality and surround effect of DVD Audio, you must use 5.1 channel analog audio output (5.1CH AUDIO OUT jacks on the DVD/CD Receiver).

### Moving to another GROUP

Some DVD Audio discs divide content into different groups. Your player enables you to quickly access different groups during playback via the on-screen display.

1. Press DISPLAY during playback on in stop mode.
2. Press ▲/▼ to select Group icon.
3. Press ◀▶ or the numbered buttons (0-9) to select a group number.

### **Note:**

Sometimes the author of the disc creates hidden content that can only be accessed by entering a password. If the lock icon appears on the TV screen, enter the password (sometimes you'll find it on the disc's jacket cover or on a web site). This password control isn't dictated by your DVD/CD Receiver — it is a function of the disc.

Since the authoring of DVD Audio Discs varies, some of the on-screen display choices might not be available for the disc you're playing.

### Viewing another PAGE

Since DVD Audio discs can hold a lot of content, there are various ways to see what's available on the disc.

1. Press DISPLAY during playback.
2. Press ▲/▼ to select Page icon.
3. Press ◀▶ to select a page number.

What appears on the screen will vary from disc to disc because the information available depends upon the way the disc was created.

### **Note:**

Since the authoring of DVD Audio Discs varies, some of the on-screen display choices might not be available for the disc you're playing.

## Presetting the Radio Stations

You can preset 50 stations for FM and AM (MW). Before tuning, make sure that you have turned down the volume.

1. Press TUNER on the Remote Control until FM or AM (MW) appears in the display window.
2. And then every time you press TUNER, FM and AM (MW) changes alternately.
3. Press and hold TUN.(-/+) for about two seconds until the frequency indication starts to change, then release.  
Scanning stops when the DVD/CD Receiver tunes in a station.
4. Press PROG./MEMO. on the Remote Control. A preset number will flash in the display window.
5. Press PRESET (-/+) on the Remote Control to select the preset number you want.
6. Press PROG./MEMO. on the Remote Control again.  
The station is stored.
7. Repeat steps 3 to 6 to store other stations.

### To tune in a station with a weak signal

Press TUN.(-/+) repeatedly in step 3 to tune in the station manually.

### To clear all the stored stations

Press and hold PROG./MEMO. for about two seconds and "ERASE ALL" appears in the display window and then press PROG./MEMO. again, the stations are cleared.

- If you have accidentally entered into the "ERASE ALL" mode and you do not wish to clear the memory, do not press any key. After a few seconds, "ERASE ALL" will go off by itself and change to normal mode.

### Note:

If all stations have already been entered, the FULL message will appear in the display window for a moment and then a preset number will flash.

To change the preset number, follow steps 5-6 as above.

## Listening to the Radio

Preset radio stations in the DVD/CD Receiver's memory first (see "Presetting radio stations" on the left).

1. Press TUNER until FM or AM (MW) appears in the display window.  
The last received station is tuned in.
2. Press PRESET (-/+) repeatedly on the Remote Control to select the preset station you want.  
Each time you press the button, the DVD/CD Receiver tunes in one preset station at a time.
3. Adjust the volume by rotating VOLUME on the front panel or by pressing VOLUME + or - on the Remote Control repeatedly.

### To turn off the radio

Press POWER to turn the DVD/CD Receiver off or select another function mode (DVD/CD, AUX, USB).

### To listen to non-preset radio stations

- Use manual or automatic tuning.
- For manual tuning, press TUN.(-/+) repeatedly.
- For automatic tuning, press and hold TUN.(-/+) for about two seconds on the front panel.

### To select a preset radio station directly

You can use the number buttons on the Remote Control to select a preset radio station directly. For example, to listen to the preset station 4, press 4 on the Remote Control. To listen to the preset station 19, press 1 and then 9 (within 3 seconds).

### For your reference

- **If an FM program is noisy**  
Press MONO/ST. on the front panel to make "STEREO" disappear in the display window. There will be no stereo effect, but the reception will improve. Press the button again to restore the stereo effect.
- **To improve reception**  
Reorient the supplied antennas.

## Sleep Timer Setting

You can set the DVD/CD Receiver to turn off automatically at a specified time.

1. **Press SLEEP to set the desired sleep time.**  
The SLEEP indicator and the sleep time appears in the display window.
2. **Each time you press SLEEP the setting changes in the following order.**  
SLEEP 180 → 150 → 120 → 90 → 80 → 70 → 60 → 50 → 40 → 30 → 20 → 10 → OFF (No display)

### Note:

You can check the remaining time before the DVD/CD Receiver turns off.  
Press SLEEP. The remaining time appears in the display window.

## Dimmer

This function will change the brightness of the display window on the front panel during in power-on status.  
Press the DIMMER repeatedly.

## Mute

Press MUTE to mute your unit.  
You can mute your unit in order, for example, to answer the telephone, the "MUTE" indicator flashes in the display window.

## Selecting input source

You can use VCRs or other units connected to the AV IN or Optical connector. Refer to the Owner's Manual supplied with the unit for further information on the operation.

**Press AUX repeatedly on the Remote Control to select the desired input source.**

Each time you press this button, the mode of the function changes in the following sequence:

- **AUX** : for selecting the analog signal from AUX AUDIO Input (L/R) Connector.
- **AUX OPT**: for selecting the optical digital signal from OPTICAL IN Connector.
- **AUDIO IN**: for selecting the analog signal from AUDIO IN Connector.

### Notes

- The Optical input function is available only when the sampling frequency of other unit is 32 - 96kHz.
- You can also select the input source by pressing FUNC. button on the front panel.  
Press and hold this button for about 3 seconds, then press repeatedly to select other function.

## XTS/XTS pro

Each time you press **XTS pro** the setting changes in the following order.

XTS ON → NORMAL → XTS-P ON...

- **XTS-P ON**  
The unique sound quality of the LG Technology creates the optimum sound for you to play the perfect playback of the original sound and to feel the living sound source.
- **XTS ON**  
When playing a movie with weak bass relative to the general music, it forces sound to the woofer. In the mode of 2 CH BYPASS, It creates the high display effect by playing the sound source via the rear speakers same as the front speakers.

### Note

The XTS mode is temporarily disabled when changing from 2.1 CH to 5.1 CH and it is enabled when changing it to 2.1 CH.

- **NORMAL**  
XTS-P and XTS mode tune off

## VIRTUAL sound

Press **VSM** to set the VIRTUAL sound.

Source	Display	Effect
2.1 ch.	VIRTUAL	3D STEREO
5.1 ch	VIRTUAL	Multichannel sound

- **3D STEREO**  
Realtime 3D positioned sound rendering technology with stereo sources, optimized for stereo speakers. Listeners may experience amazing virtual surround effects with their own multimedia players.
- **Multichannel sound**  
The Multichannel sound changes the sound in 5.1 ch into a virtual one in the 10.1 ch so that it provides such a feeling that you listen to the sound simultaneously from the right and left speakers and center speaker.

## Sound Mode

You can enjoy surround sound simply by selecting one of the pre-programmed sound fields according to the program you want to listen to. (2 ch. sound only)

**Press SOUND button repeatedly.**

The sound mode is changed in the display window in the following order.

BYPASS → ON STAGE → STUDIO → CLUB → HALL → THEATER 1 → CHURCH → PL II MOVIE → PL II MUSIC → PL II MTRX → BYPASS...

### Note:

Initial sound mode is BYPASS.



## XM Satellite Radio Operation

### What is XM Satellite Radio?

XM Radio is the satellite radio service with millions of listeners across the U.S.

Broadcasting live daily, XM Radio offers 160 digital radio channels offering music, news, sports, comedy, talk, entertainment, traffic and weather reports, with high quality digital sound.

XM service subscription sold separately. XM Passport System required to receive XM service (sold separately). Installation costs and other fees and taxes, including a one-time activation fee may apply. XM service only available in the 48 contiguous United States. Residents in Canada please see information about Canadian Satellite Radio at the following webpage: ([www.cdnsatrad.com](http://www.cdnsatrad.com)). XM Connect-and-Play is a trademark of XM Satellite Radio Inc. ©2006 XM Satellite Radio Inc. All rights reserved.

### What is XM Ready?

An audio system labeled "XM Ready" means that the system with the addition of an XM Passport Antenna has everything you need to play XM. Everything else is built inside.

### XM Satellite Radio connections

Connect the XM Digital Antenna to the XM passport system on the unit.

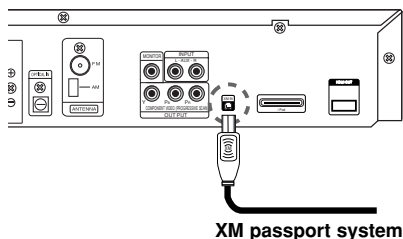

### Activating Your Service

A one-time activation fee is required to establish an account and activate service with XM Satellite Radio. Applicable activation changers will be added to your first bill.

1. Before activating XM service, make sure your XM equipment is tuned to the XM Preview Channel (Channel 1).
2. Determine your eight-character XM Satellite Radio ID number by referencing the label on your XM Passport System packaging, rear cover, or by selecting channel 0. The ID number will appear on the display.

#### Note:

Carefully check your XM Satellite Radio ID. The letter I, O, S, and F are not used

3. Activate your XM Satellite Radio service. Make sure you have a major credit card and your XM Satellite Radio ID number handy.

**To activate via the internet: Visit <http://www.xmradio.com/activation>**

**To activate via phone: Call 1-800-XM-RADIO (967-2346)**  
**A one-time activation fee will apply.**

### Selecting the XM Satellite Radio

Press TUNER on the Remote Control until "ANTENNA" appears in the display window.

#### XM information

When receiving the XM Satellite Radio containing, you can see the information in the display window.

Press XM MODE to change XM display mode.

Channel Number → Channel Label →  
Song Name/Artist Name → Signal Strength →  
Channel Number → ...

- **Channel Number :**  
**Display current XM Channel Number**  
Channel Number shows 3 seconds regardless its display mode when channel is changed.  
When user edits or change preset, it works on channel number display mode.
- **Channel Label**  
Display name of current channel.
- **Song Name & Artist Name**  
Display song name & artist name as scroll.
- **Signal Strength**  
Signal Strength is showed by 3 bars with antenna shape.  
No Bar: No Signal.  
One Bar: Weak Signal  
Two Bar: Marginal Signal  
Three Bar: Good Signal

### Presetting the XM Satellite Radio Stations

You can preset 50 stations for XM. Before tuning, make sure that you have turned down the volume.

1. Press TUNER to select XM band.
2. Use XM CH (-/+) on the Remote Control to select the desired channel.
3. Press PROG/MEMO. on the Remote Control.
4. Press PRESET (-/+) on the Remote Control to select the preset number you want.
5. Press PROG/MEMO. on the Remote Control again.  
The station is stored.
6. Repeat steps 2 to 5 to store other stations.

#### To clear all the stored stations

Press and hold PROG/MEMO. for about two seconds and "ERASE XM" is shown in the display window and then press PROG/MEMO. again, the stations are cleared.

- If you have accidentally entered into the "ERASE XM" mode and you do not wish to clear the memory, do not press any key. After a few seconds, the "ERASE XM" display will go off by itself and change to normal mode.

### Channel Selection

#### Preset Search

Use PRESET (-/+) on the Remote Control repeatedly to select the preset station you want.

#### Direct Tuning

1. Using Numeric button on Remote Control, select channel number directly.
2. Press ENTER after more than one numeric key input, system moves to new channel immediately.

#### Channel up/down

Use XM CH (-/+) repeatedly to select the channel you want.

#### Category Search

1. Select the Category Search mode using the CAT key on the Remote Control.  
(CAT Icon Blinking in Category Search mode.)
2. PRESET (-/+) changes target of category for search, XM CH - or XM CH + selects next channel of selected category in category search mode.

#### Note:

Category type of current channel displays for 3 seconds when category key is inputted in not category display mode

#### Category search mode is released below case.

- CAT is inputted in Category search mode.
- No input of PRESET (-/+) , XM CH - or XM CH + key for 15 seconds.

#### Advisory Message

ANTENNA	XM Passport System is not connected • Check the connection of XM Passport System
SVC ANT	XM Passport System does not work properly • Need service of XM Passport System
UPDATING	XM Passport System is not activated, or User does not have authorization for specific channel • Subscribe activation of XM Passport System
NO SIGNAL	Receiving signal is too weak • XM Passport System to south window for best reception
OFF AIR	Selected channel is not broadcasting currently. • Check programming list, select another channel.
LOADING	XM Passport System is now decoding channel. • Wait completion of decoding process
XM---	Selected channel is not available. • Check programming list, select another channel.
----- ---/--- -----	Channel label or Song name/Artist name or Category name is not available

## Controlling your TV with the Supplied Remote Control

You can control the sound level, input source, and power switch of your LG TV with the supplied Remote Control.

You can control your TV using the buttons below.

By pressing	You can
TV POWER	Turn the TV on or off.
CHANNEL(▲ / ▼)	Scans up or down through memorized channels.
VOLUME +/-	Adjust the volume of the TV.
TV INPUT	Switch the TV's input source between the TV and other input sources.

### Note:

Depending on the unit being connected, you may not be able to control your TV using some of the buttons.

## Controlling other TVs with the Supplied Remote Control

You can control the sound level, input source, and power switch of non-LG TVs as well. If your TV is listed in the table below, set the appropriate manufacturer code. (refer to page 28)

1. While holding down TV POWER button, press the number buttons to select the manufacturer code for your TV (Refer to table on the right column).
2. Release TV POWER button.

TV Control Buttons

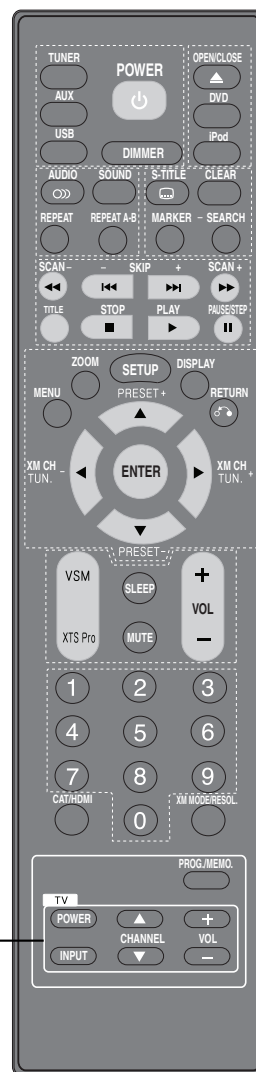

Operation

## Controlling other TVs with the Supplied Remote Control (Continued)

If more than one code number is listed, try entering them one at a time until you find the one that works with your TV.

Manufacturer	Code Number	Manufacturer	Code Number
ADMIRAL	16,33,37,44,45	MONTGOMERY	01,06,08,09
AIWA	70	WARD	23,24,32,33,34
AKAI	01	NEC	01,08
AMARK	09	NOBLEX	07
AOC	01	PACKARD BELL	43
BELL & HOWELL	33	PANASONIC	07,11,13,25,35,36
BROKSONIC	18,19	PHILCO	01,06,07,08,09, 15,38,43,58
CANDLE	51	PHILIPS	06,07,43,61,62,65
CCE	07	PIONEER	30
CENTURION	08	PORTLAND	09
CINERAL	43	PROSCAN	03,37,44
CITIZEN	49,50,51,52,53,54,55	QUASAR	11,13
CORONADO	09	RADIO SHACK	16,17,23
CROWN	09	RCA	01,03,37,44,69
CURTIS MATHES	01,03,08,33,35,37,44	REALISTIC	16,17,23
DAEWOO	16,38,39,40,41,42,43	SAMPO	08
DAYTRON	01,08	SAMSUNG	01,08,09,25,68
EMERSON	01,09,16,17,18,19	SANYO	28,29
FISHER	28,29	SCOTT	01,08
FUNAI	46,47	SEARS	09,25,26,27,28,29
GENERAL ELECTRIC	03,10,11,13,37,44	SEMP	64
GRADIENTE	01,56,57,63,67	SHARP	09,22,23,24,60,66
HITACHI	09,14,15,43	SIGNATURE 2000	01,06,08,09,10, 23,24,33,34
JC PENNEY	01,08,10,27,35	SONY	12,62
JVC	20,21,63,67	SOUNDESIGN	51
KIOTE	43	SYLVANIA	01,04,05,06,07, 08,35,51
KMC	09	SYMPHONIC	46,47
KTV	01,08,09,31	TATUNG	11
LG (GOLDSTAR)	01,07,08,09,35,39,40	TEKNIKA	07,09,16,33,51
LODGENET	33	TELERENT	09,33
LOGIK	33	THOMSON	69
LXI	09,24,25,26,27,28,29	YORX	08
MAGNAVOX	01,02,04,05,06, 07,08,09,20, 34,35,43,51,61,62,65	TOSHIBA	01,25,26,27,64
MAJESTIC	33	WARDS	01,06,08,09,10,33,34
MARANTZ	01,32	XR1000	48
MEMOREX	33	ZENITH	01, 02,33,59
MGA/MITSUBISHI	01,08,32,34		

### Notes:

- Depending on your TV, some or all buttons may not function on the TV, even after entering the correct manufacturer code.
- If you enter a new code number, the code number previously entered will be erased.
- When you replace the batteries of the remote, the code number you have set may be reset to the default setting. Set the appropriate code number again.

# Reference

## Language Codes

Use this list to input your desired language for the following initial settings:  
Disc Audio, Disc Subtitle, Disc Menu.

Language	Code	Language	Code	Language	Code	Language	Code
Abkhazian	6566	Fiji	7074	Lingala	7678	Singhalese	8373
Afar	6565	Finnish	7073	Lithuanian	7684	Slovak	8375
Afrikaans	6570	French	7082	Macedonian	7775	Slovenian	8376
Albanian	8381	Frisian	7089	Malagasy	7771	Somali	8379
Ameharic	6577	Galician	7176	Malay	7783	Spanish	6983
Arabic	6582	Georgian	7565	Malayalam	7776	Sudanese	8385
Armenian	7289	German	6869	Maltese	7784	Swahili	8387
Assamese	6583	Greek	6976	Maori	7773	Swedish	8386
Aymara	6588	Greenlandic	7576	Marathi	7782	Tagalog	8476
Azerbaijani	6590	Guarani	7178	Moldavian	7779	Tajik	8471
Bashkir	6665	Gujarati	7185	Mongolian	7778	Tamil	8465
Basque	6985	Hausa	7265	Nauru	7865	Tatar	8484
Bengali; Bangla	6678	Hebrew	7387	Nepali	7869	Telugu	8469
Bhutani	6890	Hindi	7273	Norwegian	7879	Thai	8472
Bihari	6672	Hungarian	7285	Oriya	7982	Tibetan	6679
Breton	6682	Icelandic	7383	Panjabi	8065	Tigrinya	8473
Bulgarian	6671	Indonesian	7378	Pashto, Pushto	8083	Tonga	8479
Burmese	7789	Interlingua	7365	Persian	7065	Turkish	8482
Byelorussian	6669	Irish	7165	Polish	8076	Turkmen	8475
Cambodian	7577	Italian	7384	Portuguese	8084	Twi	8487
Catalan	6765	Japanese	7465	Quechua	8185	Ukrainian	8575
Chinese	9072	Javanese	7487	Rhaeto-Romance	8277	Urdu	8582
Corsican	6779	Kannada	7578	Rumanian	8279	Uzbek	8590
Croatian	7282	Kashmiri	7583	Russian	8285	Vietnamese	8673
Czech	6783	Kazakh	7575	Samoan	8377	Volapük	8679
Danish	6865	Kirghiz	7589	Sanskrit	8365	Welsh	6789
Dutch	7876	Korean	7579	Scots Gaelic	7168	Wolof	8779
English	6978	Kurdish	7585	Serbian	8382	Xhosa	8872
Esperanto	6979	Laotian	7679	Serbo-Croatian	8372	Yiddish	7473
Estonian	6984	Latin	7665	Shona	8378	Yoruba	8979
Faroese	7079	Latvian, Lettish	7686	Sindhi	8368	Zulu	9085

## Area Codes

Choose a area code from this list.

Area	Code	Area	Code	Area	Code	Area	Code
Afghanistan	AF	Ethiopia	ET	Malaysia	MY	Saudi Arabia	SA
Argentina	AR	Fiji	FJ	Maldives	MV	Senegal	SN
Australia	AU	Finland	FI	Mexico	MX	Singapore	SG
Austria	AT	France	FR	Monaco	MC	Slovak Republic	SK
Belgium	BE	Germany	DE	Mongolia	MN	Slovenia	SI
Bhutan	BT	Great Britain	GB	Morocco	MA	South Africa	ZA
Bolivia	BO	Greece	GR	Nepal	NP	South Korea	KR
Brazil	BR	Greenland	GL	Netherlands	NL	Spain	ES
Cambodia	KH	Heard and McDonald Islands	HM	Netherlands Antilles	AN	Sri Lanka	LK
Canada	CA	Hong Kong	HK	New Zealand	NZ	Sweden	SE
Chile	CL	Hungary	HU	Nigeria	NG	Switzerland	CH
China	CN	India	IN	Norway	NO	Taiwan	TW
Colombia	CO	Indonesia	ID	Oman	OM	Thailand	TH
Congo	CG	Israel	IL	Pakistan	PK	Turkey	TR
Costa Rica	CR	Italy	IT	Panama	PA	Uganda	UG
Croatia	HR	Jamaica	JM	Paraguay	PY	Ukraine	UA
Czech Republic	CZ	Japan	JP	Philippines	PH	United States	US
Denmark	DK	Kenya	KE	Poland	PL	Uruguay	UY
Ecuador	EC	Kuwait	KW	Portugal	PT	Uzbekistan	UZ
Egypt	EG	Libya	LY	Romania	RO	Vietnam	VN
El Salvador	SV	Luxembourg	LU	Russian Federation	RU	Zimbabwe	ZW

## Troubleshooting

Check the following guide for the possible cause of a problem before contacting service.

Symptom	Cause	Correction
No power.	<ul style="list-style-type: none"> <li>The power cord is disconnected.</li> </ul>	<ul style="list-style-type: none"> <li>Plug the power cord securely into the wall outlet.</li> </ul>
The power is on, but the DVD/CD Receiver does not work.	<ul style="list-style-type: none"> <li>No disc is inserted.</li> </ul>	<ul style="list-style-type: none"> <li>Insert a disc. (Check that the DVD or, audio CD indicator in the DVD display is lit.)</li> </ul>
No picture.	<ul style="list-style-type: none"> <li>The TV is not set to receive DVD signal output.</li> </ul>	<ul style="list-style-type: none"> <li>Select the appropriate video input mode on the TV so the picture from the DVD/CD Receiver appears on the TV screen.</li> </ul>
	<ul style="list-style-type: none"> <li>The video cable is not connected securely.</li> </ul>	<ul style="list-style-type: none"> <li>Connect the video cable into the jacks securely.</li> </ul>
	<ul style="list-style-type: none"> <li>The connected TV power is turned off.</li> </ul>	<ul style="list-style-type: none"> <li>Turn on the TV.</li> </ul>
There is no sound or only a very low-level sound is heard.	<ul style="list-style-type: none"> <li>The equipment connected with the audio cable is not set to receive DVD signal output.</li> </ul>	<ul style="list-style-type: none"> <li>Select the correct input mode of the audio receiver so you can hear the sound from the DVD/CD Receiver.</li> </ul>
	<ul style="list-style-type: none"> <li>The audio cables are not connected securely.</li> </ul>	<ul style="list-style-type: none"> <li>Connect the audio cable into the jacks securely.</li> </ul>
	<ul style="list-style-type: none"> <li>The power of the equipment connected with the audio cable is turned off.</li> </ul>	<ul style="list-style-type: none"> <li>Turn on the equipment connected with the audio cable.</li> </ul>
	<ul style="list-style-type: none"> <li>The audio connecting cable is damaged.</li> </ul>	<ul style="list-style-type: none"> <li>Replace it with new one.</li> </ul>
The playback picture is poor.	<ul style="list-style-type: none"> <li>The disc is dirty.</li> </ul>	<ul style="list-style-type: none"> <li>Clean the disc.</li> </ul>
The DVD/CD Receiver does not start playback.	<ul style="list-style-type: none"> <li>No disc is inserted.</li> </ul>	<ul style="list-style-type: none"> <li>Insert a disc. (Check that the DVD, or audio CD indicator in the DVD display is lit.)</li> </ul>
	<ul style="list-style-type: none"> <li>An unplayable disc is inserted.</li> </ul>	<ul style="list-style-type: none"> <li>Insert a playable disc. (Check the disc type, colour system and Regional code.)</li> </ul>
	<ul style="list-style-type: none"> <li>The disc is placed upside down.</li> </ul>	<ul style="list-style-type: none"> <li>Place the disc with the playback side down.</li> </ul>
	<ul style="list-style-type: none"> <li>The disc is not placed within the guide.</li> </ul>	<ul style="list-style-type: none"> <li>Place the disc on the disc tray correctly inside the guide.</li> </ul>
	<ul style="list-style-type: none"> <li>The disc is dirty.</li> </ul>	<ul style="list-style-type: none"> <li>Clean the disc.</li> </ul>
	<ul style="list-style-type: none"> <li>A menu is on the TV screen.</li> </ul>	<ul style="list-style-type: none"> <li>Press the SETUP button to turn off the menu screen.</li> </ul>
	<ul style="list-style-type: none"> <li>The Rating level is set.</li> </ul>	<ul style="list-style-type: none"> <li>Cancel the Rating function or change the rating level.</li> </ul>
Loud hum or noise is heard.	<ul style="list-style-type: none"> <li>The disc is dirty.</li> </ul>	<ul style="list-style-type: none"> <li>Clean the disc.</li> </ul>
	<ul style="list-style-type: none"> <li>The speakers and components are connected poorly.</li> </ul>	<ul style="list-style-type: none"> <li>Connect the speakers and components securely.</li> </ul>
	<ul style="list-style-type: none"> <li>The DVD/CD Receiver is located too close to the TV.</li> </ul>	<ul style="list-style-type: none"> <li>Move your TV away from the audio components.</li> </ul>

Symptom	Cause	Correction
Radio stations cannot be tuned in.	<ul style="list-style-type: none"> <li>The antenna is positioned or connected poorly.</li> </ul>	<ul style="list-style-type: none"> <li>Connect the antenna securely.</li> <li>Adjust the antennas and connect an external antenna if necessary.</li> </ul>
	<ul style="list-style-type: none"> <li>The signal strength of the stations is too weak (when tuning in with automatic tuning).</li> </ul>	<ul style="list-style-type: none"> <li>Tune in the station manually.</li> </ul>
	<ul style="list-style-type: none"> <li>No stations have been preset or preset stations have been cleared (when tuning by scanning preset stations).</li> </ul>	<ul style="list-style-type: none"> <li>Preset the stations (page 23).</li> </ul>
The Remote Control does not work properly.	<ul style="list-style-type: none"> <li>The Remote Control is not pointed at the remote sensor of the DVD/CD Receiver.</li> </ul>	<ul style="list-style-type: none"> <li>Point the Remote Control at the Remote Sensor of the DVD/CD Receiver.</li> </ul>
	<ul style="list-style-type: none"> <li>The Remote Control is too far from the DVD/CD Receiver.</li> </ul>	<ul style="list-style-type: none"> <li>Use the Remote Control within about 23 ft (7 m).</li> </ul>
	<ul style="list-style-type: none"> <li>There is an obstacle in the path of the Remote Control and the DVD/CD Receiver.</li> </ul>	<ul style="list-style-type: none"> <li>Remove the obstacle.</li> </ul>
	<ul style="list-style-type: none"> <li>The batteries in the Remote Control are flat.</li> </ul>	<ul style="list-style-type: none"> <li>Replace the batteries with new ones.</li> </ul>
The front panel display is too dim.	<ul style="list-style-type: none"> <li>Nothing is displayed on the front panel display.</li> </ul>	<ul style="list-style-type: none"> <li>Press DIMMER on the Remote Control.</li> </ul>

## Specifications

General	Power supply	Refer to main label.		
	Power consumption	Refer to main label.		
	Net Weight	3.9 kg		
	External dimensions (W x H x D)	430 x 70 x 310 mm		
	Operating conditions	Temperature: 5°C to 35°C, Operation status: Horizontal		
	Operating humidity	5% to 85%		
	Laser	Semiconductor laser, wavelength 650 nm		
CD/DVD	Signal system	NTSC 525/60		
	Frequency response (audio)	200 Hz to 18 kHz		
	Signal-to-noise ratio (audio)	More than 75 dB (1 kHz, NOP -6 dB, 20 kHz LPF/A-Filter)		
	Dynamic range (audio)	More than 70 dB		
Video	Harmonic distortion (audio)	0.5 % (1 kHz, at 1W position) (20 kHz LPF)		
	Video input	1.0 V (p-p), 75 Ω, negative sync., RCA jack x 1		
	Video output	1.0 V (p-p), 75 Ω, negative sync., RCA jack x 1		
Tuner	COMPONENT VIDEO OUT	(Y) 1.0 V (p-p), 75 ohms, negative sync, RCA jack x 1 (P <sub>B</sub> )/(P <sub>R</sub> ) 0.7 V (p-p), 75 ohms, RCA jack x 1		
	FM	Tuning Range	87.5 - 108.0 MHz or 65.0 - 74.0 MHz, 87.5 - 108.0 MHz	
		Intermediate Frequency	10.7 MHz	
		Signal-to Noise Ratio	60 dB (Mono)	
	AM [MW]	Frequency Response	140 - 10,000 Hz	
		Tuning Range	522 - 1,620 kHz or 520 - 1,720 kHz	
	Amplifier	Intermediate Frequency	450 kHz	
Stereo mode		155 W + 155 W (4Ω at 1 kHz, THD 10 %)		
Surround mode (* Depending on the sound mode settings and the source, there may be no sound output.)		Front: 155 W + 155 W (THD 10 %) Center*: 155 W Surround*: 155 W + 155 W (4Ω at 1 kHz, THD 10 %) Subwoofer*: 225 W (3Ω at 30 Hz, THD 10 %)		
Inputs		AUDIO IN, OPTICAL IN		
Outputs		MONITOR OUT, HDMI OUT, COMPONENT VIDEO OUT		
Speakers		Front/Rear Speaker (SH92SB-S)	Center speaker (SH92SB-C)	Passive Subwoofer (SH92SB-W)
	Type	1 Way 1 Speaker	2 Way 3 Speaker	1 Way 1 Speaker
	Impedance	4 Ω	4 Ω	3 Ω
	Frequency Response	120 - 18000 Hz	120 - 18000 Hz	40 - 1500 Hz
	Sound Pressure Level	83 dB/W (1m)	83 dB/W (1m)	82 dB/W (1m)
	Rated Input Power	155 W	155 W	225 W
	Max. Input Power	310 W	310 W	450 W
	Net Dimensions (W x H x D)	113 x 209 x 83 mm	301 x 118 x 83 mm	258 x 440 x 401 mm
Net Weight	0.83 kg	1.8 kg	6.8 kg	





## LG Electronics, Inc. Limited Warranty - USA

This LG Electronics product, will be repaired or replaced, at LG's option, if it proves to be defective in material or workmanship, under normal use, during the warranty period ("Warranty Period") listed below, effective from the date ("Date of Purchase") of original consumer purchase of the product. This warranty is good only to the original purchaser of the product and effective only when used in the United States, excluding U.S. Territories.

<b>WARRANTY PERIOD:</b> <b>LABOR: 90 days</b> from the Date of Purchase. <b>PARTS: One Year</b> from the Date of Purchase.  * Parts replaced are warranted for the remaining portion of the original warranty period.	<b>HOW SERVICE IS HANDLED:</b> <b>Call 1-800-243-0000</b> for instructions on getting the defective unit repaired or replaced. <b>Please retain dated sales receipt and your box</b> to return the unit to LG for repair or replacement.  Shipping both ways will be paid by LG during the first 90 days of the Warranty Period. During the remainder of the Warranty Period (91-365 days), you pay inbound shipping charges and LG pays return shipping charges.  Visit our website at: <a href="http://www.lgservice.com">http://www.lgservice.com</a>
---	--

**THIS WARRANTY IS IN LIEU OF ANY OTHER WARRANTIES, EXPRESS OR IMPLIED, INCLUDING WITHOUT LIMITATION, ANY WARRANTY OF MERCHANTABILITY OR FITNESS FOR A PARTICULAR PURPOSE. TO THE EXTENT ANY IMPLIED WARRANTY IS REQUIRED BY LAW, IT IS LIMITED IN DURATION TO THE EXPRESS WARRANTY PERIOD ABOVE. LG ELECTRONICS WILL NOT BE LIABLE FOR ANY INCIDENTAL, CONSEQUENTIAL, INDIRECT, SPECIAL OR PUNITIVE DAMAGES OF ANY NATURE, EVEN IF ADVISED OF THE POSSIBILITY OF SUCH DAMAGES, INCLUDING WITHOUT LIMITATION, LOST REVENUES OR PROFITS, LOST OR CORRUPTED PROGRAMMING OR DATA, OR ANY OTHER DAMAGE WHETHER BASED IN CONTRACT, TORT OR OTHERWISE.** Some states do not allow the exclusion or limitation of incidental or consequential damages or limitation on how long an implied warranty lasts, so the above exclusion or limitation may not apply to you. This warranty gives you specific legal rights and you may also have other rights that may vary from state to state.

#### **THIS LIMITED WARRANTY DOES NOT APPLY TO:**

- Damages or operating problems that result from shipping, installation, adjustment of user controls, calibration, maintenance or failure to maintain, or separate system components; and
- Damages or operating problems that result from normal wear and tear, misuse, abuse, operation outside environmental specifications or contrary to the requirements or precautions in the Operating Guide, accident, lightning strikes or other natural causes, unauthorized modification or alteration, incorrect electrical current or voltage, reception problem caused by inadequate home antenna or faulty antenna connections, computer software, institutional or commercial use, or other causes not arising out of defect in material or workmanship.

Therefore, the cost of repair or replacement of such defective product shall be borne by the consumer.

#### **CUSTOMER INTER-ACTIVE CENTER NUMBERS:**

<b>For nearest Authorized Service Center, Where to buy, Product Assistance, or Customer Assistance</b>	<b>Call 1-800-243-0000</b> (24 hours a day, 365 days per year) and select appropriate options from the menu.  Or visit our website at <a href="http://www.lgservice.com">http://www.lgservice.com</a>
--	---

LG ELECTRONICS U.S.A., INC.  
1000 SYLVAN AVENUE  
ENGLEWOOD CLIFFS, NJ.

P/NO : MFL34656568  
Issue O  
Printed in Indonesia

## Free Manuals Download Website

<http://myh66.com>

<http://usermanuals.us>

<http://www.somanuals.com>

<http://www.4manuals.cc>

<http://www.manual-lib.com>

<http://www.404manual.com>

<http://www.luxmanual.com>

<http://aubethermostatmanual.com>

Golf course search by state

<http://golfingnear.com>

Email search by domain

<http://emailbydomain.com>

Auto manuals search

<http://auto.somanuals.com>

TV manuals search

<http://tv.somanuals.com>