



**5 Disc DVD COMBI
HOME THEATER SYSTEM
OWNER'S MANUAL
MODEL: LHX-557**



**Before connecting up, operating or repairing this product,
please read this instruction booklet carefully and
completely.**



WARNING: TO REDUCE THE RISK OF ELECTRIC SHOCK, DO NOT REMOVE COVER (OR BACK) NO USER-SERVICEABLE PARTS INSIDE REFER SERVICING TO QUALIFIED SERVICE PERSONNEL.



This lightning flash with arrowhead symbol within an equilateral triangle is intended to alert the user to the presence of uninsulated dangerous voltage within the product's enclosure that may be of sufficient magnitude to constitute a risk of electric shock to persons.



The exclamation point within an equilateral triangle is intended to alert the user to the presence of important operating and maintenance (servicing) instructions in the literature accompanying the appliance.

WARNING: TO REDUCE THE RISK OF FIRE OR ELECTRIC SHOCK, DO NOT EXPOSE THIS PRODUCT TO RAIN OR MOISTURE.

WARNING: Do not install this equipment in a confined space such as a book case or similar unit.

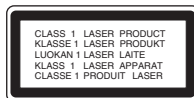

CAUTION:

This Digital Video Disc Receiver employs a Laser System.

To ensure proper use of this product, please read this owner's manual carefully and retain for future reference. Should the unit require maintenance, contact an authorized service location-see service procedure.

Use of controls, adjustments or the performance of procedures other than those specified herein may result in hazardous radiation exposure.

To prevent direct exposure to laser beam, do not try to open the enclosure. Visible laser radiation when open. **DO NOT STARE INTO BEAM.**

CAUTION: The apparatus shall not be exposed to water, dripping or splashing and that no objects filled with liquids, such as vases, shall be placed on the apparatus.

CAUTION concerning the Power Cord
Most appliances recommend they be placed upon a dedicated circuit;

That is, a single outlet circuit which powers only that appliance and has no additional outlets or branch circuits. Check the specification page of this owner's manual to be certain.

Do not overload wall outlets. Overloaded wall outlets, loose or damaged wall outlets, extension cords, frayed power cords, or damaged or cracked wire insulation are dangerous. Any of these conditions could result in electric shock or fire.

Periodically examine the cord of your appliance, and if its appearance indicates damage or deterioration, unplug it, discontinue use of the appliance, and have the cord replaced with an exact replacement part by an authorized servicer.

Protect the power cord from physical or mechanical abuse, such as being twisted, kinked, pinched, closed in a door, or walked upon. Pay particular attention to plugs, wall outlets, and the point where the cord exits the appliance.

REGULATORY INFORMATION:

FCC Part 15

This product has been tested and found to comply with the limits for a Class B digital device, pursuant to Part 15 of the FCC Rules. These limits are designed to provide reasonable protection against harmful interference when the product is operated in a residential installation. This product generates, uses and can radiate radio frequency energy and, if not installed and used in accordance with the instruction manual, may cause harmful interference to radio communications. However, there is no guarantee that interference will not occur in a particular installation. If this product does cause harmful interference to radio or television reception, which can be determined by turning the product off and on, the user is encouraged to try to correct the interference by one or more of the following measures:

- Reorient or relocate the receiving antenna.
- Increase the separation between the product and receiver.
- Connect the product into an outlet on a circuit different from that to which the receiver is connected.
- Consult the dealer or an experienced radio/TV technician for help.

FCC WARNING: This equipment may generate or use radio frequency energy. Changes or modifications to this equipment may cause harmful interference unless the modifications are expressly approved in the instruction manual. The user could lose the authority to operate this equipment if an unauthorized change or modification is made.

Notes on copyrights:

It is forbidden by law to copy, broadcast, show, broadcast via cable, play in public, or rent copyright material without permission.

This product is equipped with copy protection measures developed by Macrovision. Copy protection signals are recorded on some discs. When recording these discs on a VCR, picture noise will appear during playback.

This product incorporates copyright protection technology that is protected by certain U.S. patent claims and other intellectual property rights owned by Macrovision Corporation and other rights owners. Use of this copyright protection technology must be authorized by Macrovision Corporation, and is intended for home and other limited viewing uses only unless otherwise authorized by Macrovision Corporation. Reverse engineering or disassembly is prohibited.

SERIAL NUMBER: The serial number is found on the back of this unit. This number is unique to this unit and not available to others. You should record requested information here and retain this guide as a permanent record of your purchase.

Model No. _____

Serial No. _____

IMPORTANT SAFETY INSTRUCTIONS

CAUTION: PLEASE READ AND OBSERVE ALL WARNINGS AND INSTRUCTIONS IN THIS OWNER'S MANUAL AND THOSE MARKED ON THE UNIT. RETAIN THIS MANUAL FOR FUTURE REFERENCE.

This set has been designed and manufactured to assure personal safety. Improper use can result in electric shock or fire hazard. The safeguards incorporated in this unit will protect you if you observe the following procedures for installation, use, and servicing.

This unit does not contain any parts that can be repaired by the user.

DO NOT REMOVE THE CABINET COVER, OR YOU MAY BE EXPOSED TO DANGEROUS VOLTAGE. REFER SERVICING TO QUALIFIED SERVICE PERSONNEL ONLY.

1. **Read these instructions.** - All these safety and operating instructions should be read before the product is operated.
2. **Keep these instructions.** - The safety, operating and use instructions should be retained for future reference.
3. **Heed all warnings.** - All warnings on the product and in the operating instructions should be adhered to.
4. **Follow all instructions.** - All operating and use instructions should be followed.
5. **Do not use this apparatus near water.** - For example: near a bath tub, wash bowl, kitchen sink, laundry tub, in a wet basement; or near a swimming pool; and like.
6. **Clean only with dry cloth.** - Unplug this product from the wall outlet before cleaning. Do not use liquid cleaners.
7. **Do not block any ventilation openings. Install in accordance with the manufacturer's instructions.** - Slots and openings in the cabinet are provided for ventilation and to ensure reliable operation of the product and to protect it from over- heating. The openings should never be blocked by placing the product on a bed, sofa, rug or other similar surface. This product should not be placed in a built-in installation such as a bookcase or rack unless proper ventilation is provided or the manufacturer's instructions have been adhered to.
8. **Do not install near any heat sources such as radiators, heat registers, stoves, or other apparatus (including amplifiers) that produce heat.**
9. **Do not defeat the safety purpose of the polarized or grounding-type plug.** A polarized plug has two blades with one wider than the other. A grounding type plug has two blades and a third grounding prong. The wide blade or the third prong are provided for your safety. If the provided plug does not fit into your outlet, consult an electrician for replacement of the obsolete outlet.
10. **Protect the power cord from being walked on or pinched particularly at plugs, convenience receptacles, and the point where they exit from the apparatus.**
11. **Only use attachments/accessories specified by the manufacturer.**
12. **Use only with the cart, stand, tripod, bracket, or table specified by the manufacturer, or sold with apparatus. When a cart is used, use caution when moving the cart/apparatus combination to avoid injury from tip-over.**
13. **Unplug this apparatus during lightning storms or when unused for long periods of time.**
14. **Refer all servicing to qualified service personnel.** Servicing is required when the apparatus has been damaged in any way, such as power-supply cord or plug is damaged, liquid has been spilled or objects have fallen into the apparatus, the apparatus has been exposed to rain or moisture, does not operate normally, or has been dropped.



Contents

Introduction3-12

IMPORTANT SAFETY INSTRUCTIONS	3
Symbol used in this Manual	6
About the  Symbol Display	6
Notes on Discs	6
HANDLING DISCS	6
STORING DISCS	6
CLEANING DISCS	6
Types of Playable Discs	7
Regional code	7
Disc-related terms	8
REMOTE CONTROL OPERATION RANGE	8
REMOTE CONTROL BATTERY INSTALLATION	8
Front Panel	9
Display Window	10
Remote Control	11
Rear Panel	12

System Setup13-28

Connections	13-18
CONNECTING ANTENNA/CABLE TV TO COMBI RECEIVER	13
Cable Service Without Cable Box	13
Cable Service With Cable Box	13
CONNECTING TO A TV	14
RF coaxial connection	14
Audio/Video connection	14
S-Video connection	14
Component Video (ColorStream) connection	14
Progressive Scan (ColorStream pro) connection	14
ANTENNA CONNECTIONS	15
ACCESSORY AUDIO/VIDEO (A/V) CONNECTIONS TO COMBI RECEIVER	16
HDMI CONNECTION	17
About HDMI	17
SPEAKER SYSTEM CONNECTION	18
Speaker Positioning	19
Mini Glossary	20
Sound Mode	20
VCR Operation Setup	21-23
ON-SCREEN DISPLAY (OSD)	21
Easy Information	21
ON-SCREEN MENUS SETUP	21
Menu Selection	21
VCR SETUP MENU OPTIONS	22
CHANNEL SELECTION	22
Auto Channel Programming	22
To Add or Erase Channels from Memory	22
SETTING THE CLOCK	23
Auto Clock Set	23
Manual Clock Set	23

DVD Operation Setup24-28

ON-SCREEN DISPLAY	24
Playback Status/Restrictions	24
INITIAL SETTINGS	25
GENERAL OPERATION	25
LANGUAGE	25
Menu Language	25
Disc Audio / Subtitle / Menu	25
DISPLAY	25
TV Aspect	25
Display Mode	25
Progressive Scan	25
AUDIO	26
5.1 Speaker Setup	26
Dynamic Range Control (DRC)	26
Vocal	26
LOCK (Parental Control)	27
Rating	27
Password (Security Code)	27
Country Code	27
OTHERS	28
Auto Play	28
B.L.E. (Black Level Expansion)	28

Operation29-49

VCR Operation	29-34
TRACKING CONTROL	29
TRACKING CONTROL	29
Auto Tracking	29
Manual Tracking	29
Special Effects Playbacks	29
SEARCH	29
STILL P[LAYBACK AND FRAME-BY-FRAME PLAYBACK	29
SLOW MOTION	29
CM SKIP (COMMERCIAL SKIP)	29
Normal Recording	30
PAUSING THE RECORDING TO RECORD ONE TV PROGRAMME WHILE WATCHING ANOTHER	30
Timer Recording	30-31
CHECKING (ERASING) TIMER RECORD PROGRAMMING	31
PROGRAM PRIORITY	31
Instant Timer Recording	32
CHECKING THE RECORDING TIME TO EXTEND THE RECORDING TIME	32
Dubbing and Editing	32
Copying from DVD to VCR	32
VHS Hi-Fi Stereo System/MTS Broadcast	33
MTS (MULTICHANNEL TV SOUND)	33
MULTICHANNEL TV SOUND INDICATOR	33
SAP (SECOND AUDIO SOUND PROGRAM)	33
Tape Counter Memory Feature	34
REAL-TIME COUNTER	34
COUNTER MEMORY FEATURE	34
TAPE REMAINING	34
Additional Information	34
Auto Play System	34

Operation (Continued)	29-49
DVD Operation	35-49
PLAYING A DVD	35
• To Insert Discs	35
• To Open All Discs	35
• To Select a Playback Discs	35
• To Replace Discs During Playback	35
• To Play All Discs on the Disc Trays	35
General Features	36
MOVING TO ANOTHER TITLE/GROUP	36
MOVING TO ANOTHER CHAPTER/TRACK	36
SEARCH	36
STILL PICTURE AND FRAME-BY-FRAME PLAYBACK	36
SLOW SCAN	36
REPEAT A-B	36
REPEAT	37
3D SURROUND	37
TIME SEARCH	37
ZOOM	37
MARKER SEARCH	37
PAUSE	37
Special DVD Features	38
CHECKING THE CONTENTS OF DVD DISCS: MENUS	38
TITLE MENU	38
DISC MENU	38
CAMERA ANGLE	38
CHANGING THE AUDIO LANGUAGE	38
SUBTITLES	38
DVD Audio Discs	39
MOVING TO ANOTHER GROUP	39
VIEWING ANOTHER PAGE	39
Playing an Audio CD or MP3/WMA Disc	40
AUDIO CD	40
MP3/WMA	40
Audio CD and MP3 / WMA Disc Features	41
PAUSE	41
MOVING TO ANOTHER TRACK	41
REPEAT TRACK/ALL/OFF	41
SEARCH	41
REPEAT A-B	41
3D SURROUND	41
Programmed Playback	42
REPEAT PROGRAMMED TRACKS	42
ERASING A TRACK FROM PROGRAM LIST	42
ERASING THE COMPLETE PROGRAM LIST	42
Viewing a JPEG Disc	43
SLIDE SHOW	43
STILL PICTURE	43
MOVING TO ANOTHER FILE	43
ZOOM	43
TO ROTATE PICTURE	43
TO LISTEN TO MP3/WMA MUSIC WATCHING PICTURE	43
Playing a DVD VR format Disc	44
Maintenance and Service	44
HANDLING THE UNIT	44
Playing a DivX Movie Disc	45
5.1 Speaker Setup	46
SPEAKER SETUP	46
Additional Features	47
SCREEN SAVER	47
VIDEO MODE SETTING	47
XTS (EXCELLENT TRUE SOUND)	47
DVD Operation	48-49
PRESETTING THE RADIO STATIONS	48
LISTENING TO THE RADIO	48
TO CLEAR THE STORED RADIO STATIONS	48
TUNING STATIONS MANUALLY	49
FOR YOUR REFERENCE	49
TUNING STATIONS AUTOMATICALLY	49
LABELING STATIONS	49
Reference	50-55
Controlling your TV with the Supplied Remote	50
Controlling other TVs with the Supplied Remote	50
Code Numbers of Controllable TVs	50
Language Codes	51
Country Codes	51
Troubleshooting	52-53
Specifications	54-55

Introduction

To ensure proper use of this product, please read this Owner's Manual carefully and retain for future reference.

This manual provides information on the operation and maintenance of your Combi Home Theater System. Should the unit require service, contact an Authorized Service Center.

Symbols Used in this Manual



The lightning flash symbol alerts you to the presence of dangerous voltage within the product enclosure that may constitute a risk of electric shock.



The exclamation point alerts you to the presence of important operating and maintenance / servicing instructions.



Indicates hazards likely to cause harm to the unit itself or other material damage.

Note:

Indicates special notes and operating features.

Tip:

Indicates tips and hints for making the task easier.

A section whose title has one of the following symbols is applicable only to the disc represented by the symbol.

- DVD-V** DVD and finalized DVD±R/RW
- DVD-A** DVD Audio discs
- CD** Audio CDs
- MP3** MP3 Discs
- WMA** WMA Discs
- JPEG** JPEG Discs
- DivX** DivX Discs

About the Symbol Display

"" may appear on your TV display during operation and indicates that the function explained in this owner's manual is not available on that specific DVD video disc, or at the moment.

Notes on Discs

HANDLING DISCS

Do not touch the playback side of the disc. Hold the disc by the edges so that fingerprints do not get on the surface. Never stick paper or tape on the disc.

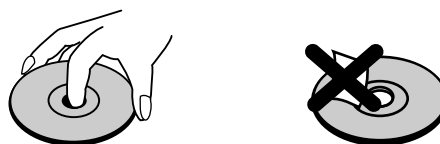

STORING DISCS

After playing, store the disc in its case. Do not expose the disc to direct sunlight or sources of heat and never leave it in a parked car exposed to direct sunlight.

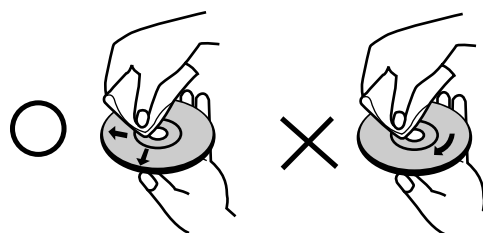

CLEANING DISCS

Fingerprints and dust on the disc can cause poor picture quality and sound distortion. Before playing, clean the disc with a clean cloth. Wipe the disc from the center out.



Do not use strong solvents such as alcohol, benzene, thinner, commercially available cleaners, or anti-static spray intended for older vinyl records.

Types of Playable Discs

	DVD (8 cm / 12 cm disc)
	DVD audio discs (8 cm / 12 cm disc)
	Audio CD (8 cm / 12 cm disc)

In addition, this unit plays DivX files, DVD -R, DVD +R, DVD -RW, DVD +RW, and CD-R / CD-RW that contains audio titles, MP3, WMA, and/or JPEG files.

Notes:

- Depending on the conditions of the recording equipment or the CD-R/RW (or DVD -R, DVD +R, DVD -RW, DVD +RW) disc itself, some CD-R/RW (or DVD -R, DVD +R, DVD -RW, DVD +RW) discs cannot be played on the unit.
- Do not attach any seal or label to either side (the labeled side or the recorded side) of a disc.
- Do not use irregularly shaped CDs (e.g., heart-shaped or octagonal) since they may result in malfunctions.

Notes on DVDs

Some playback operations of DVDs may be intentionally programmed by software manufacturers. This unit plays DVDs according to disc content designed by the software manufacturer, therefore some playback features may not be available or other functions may be added.

Regional code

This Home Theater System is designed and manufactured for playback of region "1" encoded DVD software. This unit can play only DVD discs labeled "1" or "ALL".



Notes on Regional Codes

- Most DVD discs have a globe with one or more numbers in it clearly visible on the cover. This number must match your Home Theater System's regional code or the disc cannot play.
- If you try to play a DVD with a different region code from your receiver, the message "Check Regional Code" appears on the TV screen.

Manufactured under license from Dolby Laboratories. "Dolby", "Pro Logic", and the double-D symbol are trademarks of Dolby Laboratories. Confidential Unpublished works. Copyright 1992-1997 Dolby Laboratories. All rights reserved.

Manufactured under license from Digital Theater Systems, Inc. US Pat. No's. 5,451,942; 5,956,674; 5,974,380; 5,978,762; 6,487,535 and other US and world-wide patents issued and pending. "DTS" and "DTS Digital Surround" are registered trademarks of Digital Theater Systems, Inc. Copyright 1996, 2003 Digital Theater Systems, Inc. All rights reserved.

Disc-related terms

DVD \pm R / DVD \pm RW

DVD -R and DVD +R are two different standards for recordable DVD drives and discs. This format allows information to be recorded onto the DVD disc only once. DVD +RW and DVD -RW are two standards for re-writable media, meaning the DVD content can be erased and re-recorded. Single-sided discs can hold 4.38 Gigabytes and double-sided discs hold twice as much. There are no dual layer single sided recordable discs.

MPEG

MPEG is an international standard for video and audio compression. MPEG-1 is used in encoding video for VCD and provides for multichannel surround sound coding such as PCM, Dolby Digital, DTS and MPEG audio.

MP3

MP3 is a popular compression format used for digital audio files that yields very high near-CD quality.

WMA

Windows media audio file. A type of coding / decoding developed by Microsoft Corp.

JPEG

Joint Pictures Expert Group. JPEG is a compressed file format that allows you to save images with no limit on the number of colors.

DivX

DivX is the name of a revolutionary new video codec which is based on the new MPEG-4 compression standard for video. You will be able to play DivX movies using this Combi Receiver.

Title (DVD video discs only)

A title is generally a distinct section of a DVD disc. For example the main feature could be title 1, a documentary describing how the film was made could be title 2, and cast interviews could be title 3. Each title is assigned a reference number enabling you to locate it easily.

Chapter (DVD video discs only)

A chapter is a segment of a title such as a scene in a film or one interview in a series. Each chapter is assigned a chapter number, enabling you to locate the chapter you want. Depending on the disc, chapters may not be recorded.

Group (DVD audio discs only)

The main audio content or accompanying feature content or additional feature content, or music album. Each group is assigned a group reference number enabling you to locate it easily.

Track

A distinct element of audio/visual information, such as the picture or sound track for a specific language (DVD), or a musical piece on a video or audio CD. Each track is assigned a track number, enabling you to locate the track you want. DVD discs allow one track of video (with multiple angles) and several tracks of audio.

Remote Control Operation Range

Point the Remote Control at the remote sensor and press the buttons.

- **Distance:** About 23 ft (7 m) from the front of the remote sensor.
- **Angle:** About 30° in each direction of the front of the remote sensor.

Remote Control Battery Installation

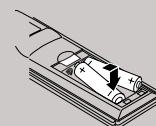

Detach the battery cover on the rear of the Remote Control, and insert two AAA batteries with \oplus and \ominus aligned correctly.

Caution

Do not mix old and new batteries. Never mix different types of batteries (standard, alkaline, etc.).

Front Panel

POWER button and indicator

Switches the Home Theater System ON and OFF.
Lights blue when the Home Theater System is turned off.

Drawer (DVD deck)

Insert discs here.

▲ EJECT ALL

Press to open all disc trays.

Cassette Compartment (VCR deck)

Insert a video cassette here.

Display window

Shows the current status of the Unit.

VOLUME Control

Turn the knob clockwise to increase sound level, counterclockwise to decrease sound level.

▲ EJECT

Ejects the tape in the VCR deck.

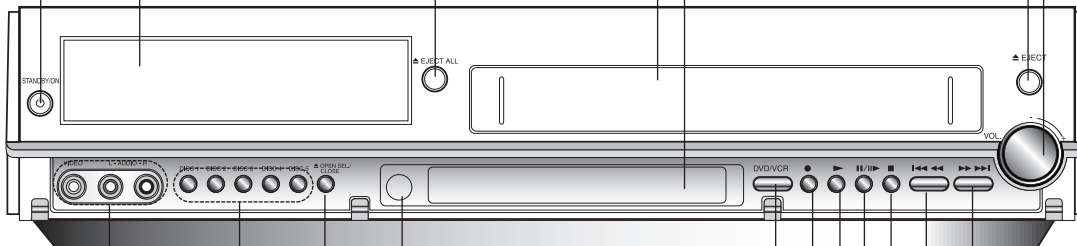

DVD/VCR

Toggles control between the DVD deck and the VCR deck.
You can also select the desired function (DVD, VCR or FM/AM).

● (REC) button

Starts recording.
Press repeatedly to set the recording time.

▶ (PLAY)

To play back a disc or tape.

PAUSE/STEP (II/II▶)

Pause playback of a tape or a disc in the DVD or VCR deck temporarily/press repeatedly for frame-by-frame playback.

Remote Sensor

Point the Unit.
Remote Control here.

■ (STOP)

Stops playback.

Reverse SKIP/SCAN (◀◀◀◀)

DVD: Goes to the beginning of current chapter/track or to the previous chapter/track.
Press and hold for two seconds for a fast reverse search.

VCR: Rewinds the tape from the STOP mode or for fast reverse picture search.

▲ OPEN SEL/CLOSE

Opens or closes the disc tray.

Disc buttons (DISC 1 - DISC 5)

Press to select the disc directly.

L 2 (VIDEO / AUDIO (Left/Right))

Connect the audio/video output of an external source (Audio system, TV/ Monitor, VCR, Camcorder, etc.).

Forward SKIP/SCAN (▶▶▶▶)

DVD: Goes to NEXT chapter/track.
Press and hold for two seconds for a fast forward search.
VCR: Advances the tape from the STOP mode or for fast forward picture search.

Display Window

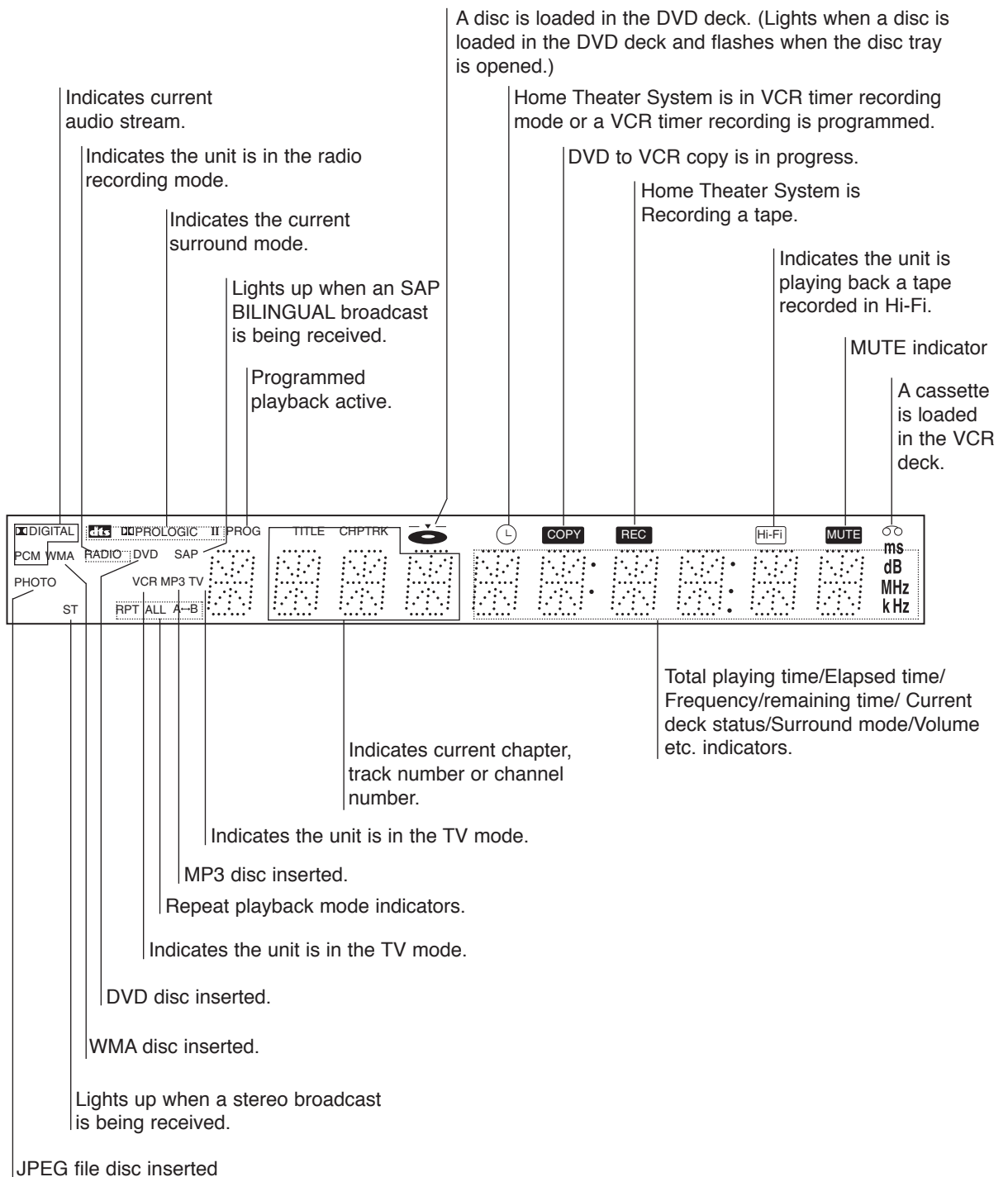

Remote Control

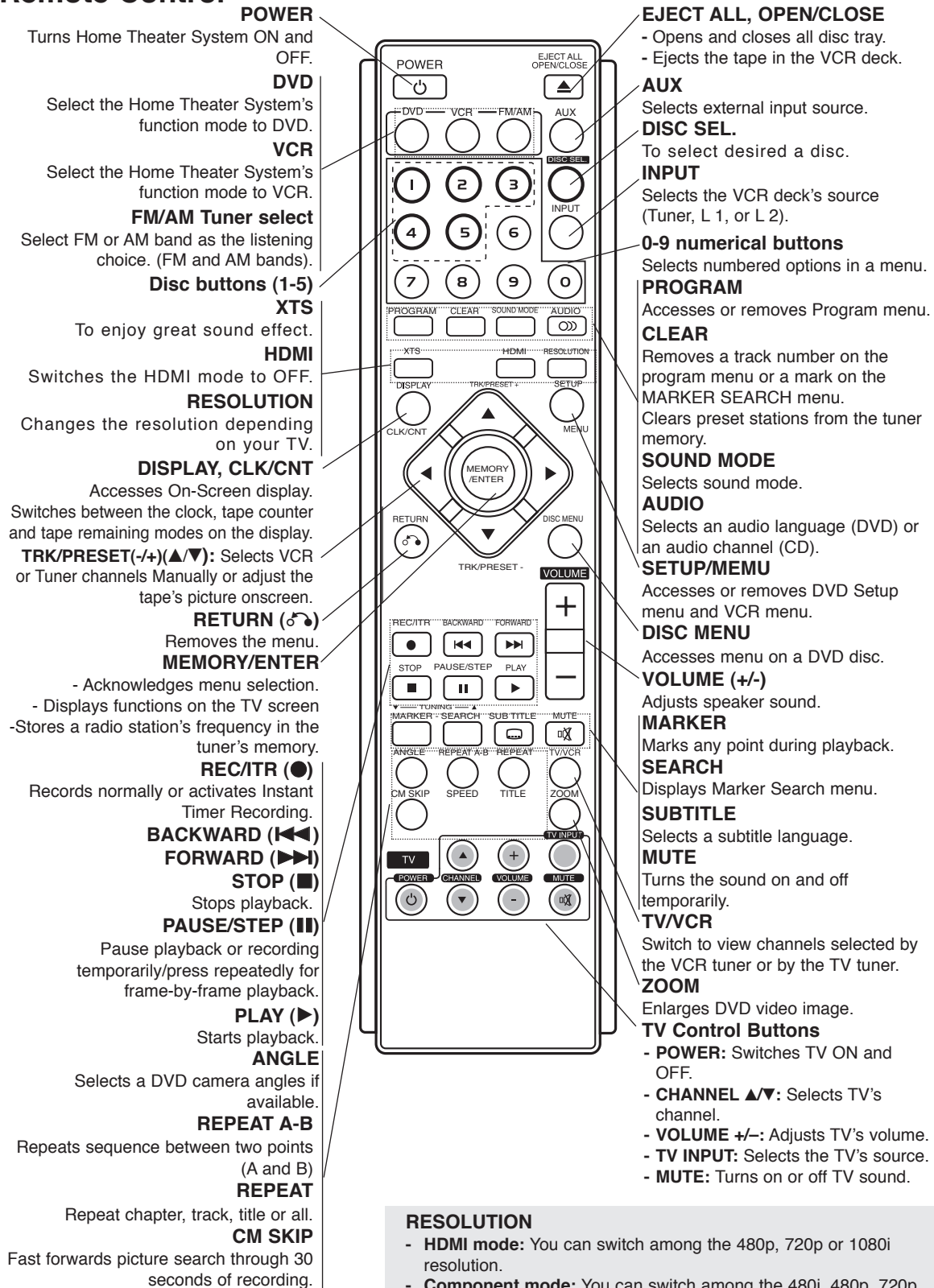

Rear Panel

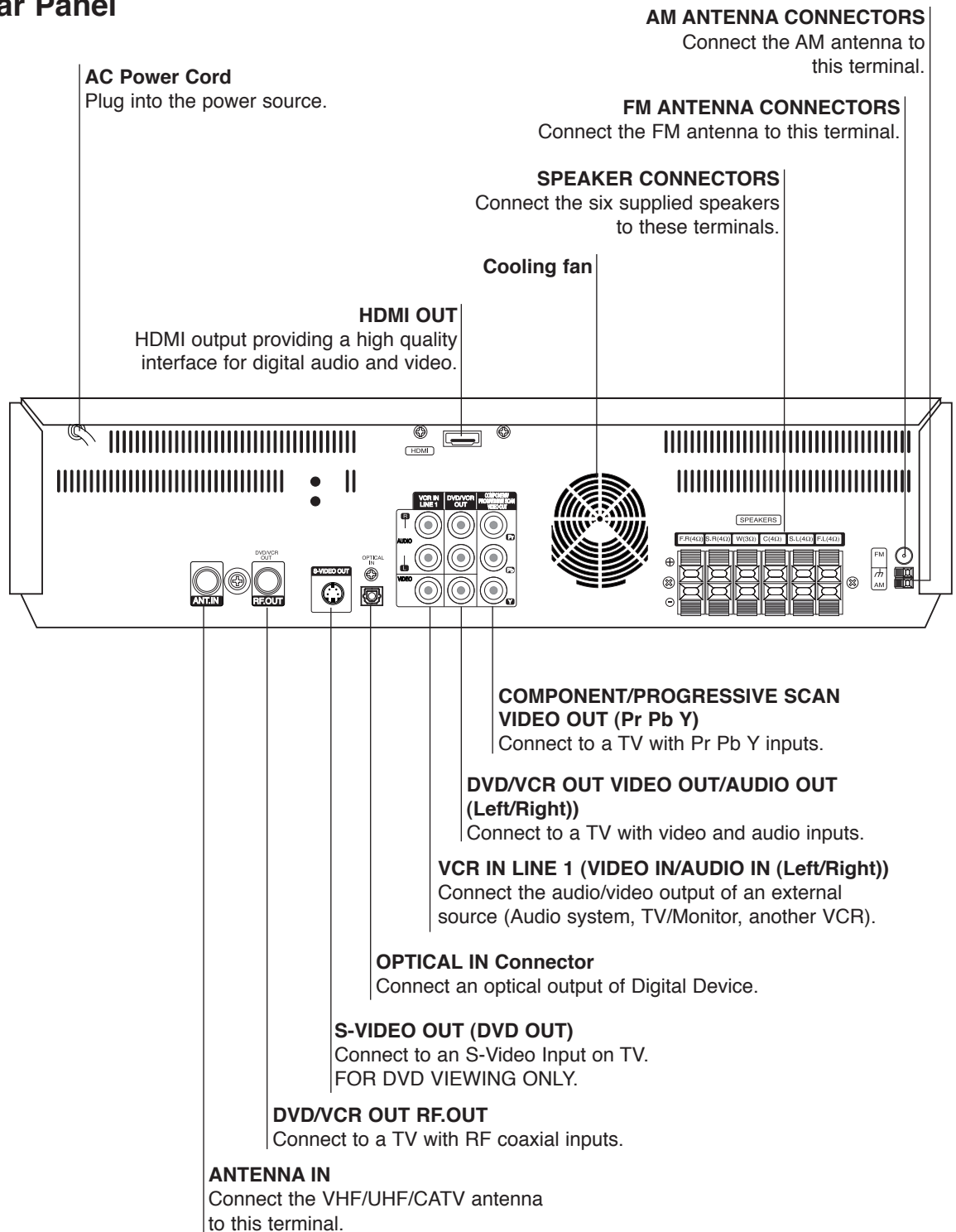

Do not touch the inner pins of the jacks on the rear panel. Electrostatic discharge may cause permanent damage to the unit.

Connections

Tips:

- Depending on your TV and other equipment you wish to connect, there are various ways you could connect the Home Theater System. Use only one of the connections described below.
- Please refer to the manuals of your TV, VCR, Stereo System or other devices as necessary to make the best connections.

Caution:

- Make sure the Home Theater System is connected directly to the TV. Tune the TV to the correct video input channel.
- Do not connect the Home Theater System's AUDIO OUT jack to the phono in jack (record deck) of your audio system.
- Do not connect your Home Theater System via your VCR. The DVD image could be distorted by the copy protection system.

Connecting Antenna/Cable TV to Home Theater System

1. Disconnect the antenna leads from the rear of the TV.
2. Identify the type of cable from your antenna. If it is a round cable as illustrated, it is a 75 ohm coaxial antenna cable. This cable will connect directly to the jack marked ANT.IN on your Recorder Combi Receiver.

Tips:

If your antenna lead wire is a flat type antenna cable, connect it to an Antenna Adapter (300-ohm to 75-ohm) (not supplied) and slip the Adapter onto the jack. The Adapter does not screw on to the Recorder Combi Receiver, it just slips over the jack.

Cable Service Without Cable Box

If your cable wire is connected to your TV without a converter or descrambler box, unscrew the wire from your TV and attach it to the ANT.IN jack on the Combi Receiver. Use the supplied round coaxial cable to connect between the Combi Receiver's RF.OUT jack and the 75 ohm antenna input jack on the TV. With this connection, you can receive all midband, super band, and hyperband channels. (All cable channels.)

Cable Service With Cable Box

If a converter is required in your cable system, follow the instruction below:

The cable hookup permits both TV and Combi Receiver operation.

To view or record a CATV channel

1. Tune the TV to the correct video input channel.
2. Set the Home Theater System channel selector to the output channel of the Cable Converter box using TRK/PRESET(-/+) (▲ / ▼) or number (0-9) of your Combi Receiver. (Example: CH3)
3. Select the channel to view at the Cable Converter Box.

Note:

If you are using a cable box to tune channels, it is not necessary to do Auto Channel Set as indicated on page 22.

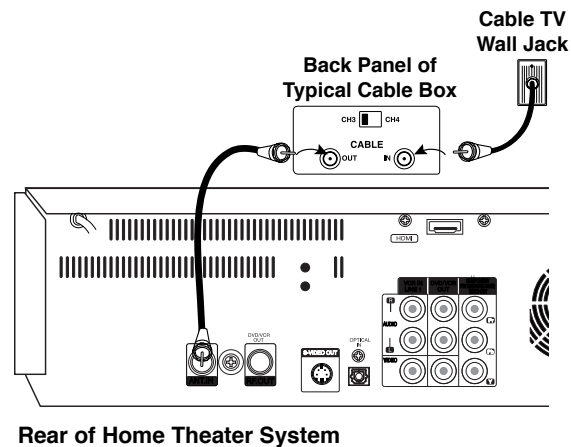

Connecting to a TV

Make one of the following connections, depending on the capabilities of your existing equipment.

RF COAXIAL CONNECTION

Connect the RF.OUT jack on the Home Theater System to the antenna in jack on the TV using the 75-ohm Coaxial Cable supplied (**R**).

Note:

If you use this connection, tune the TV to the Home Theater System's RF output channel (CH 3 or 4).

How to set the Home Theater System's RF output channel

When the Home Theater System is turned off, press and hold TRK/PRESET(-/+) (▲ or ▼) on the remote control for about five seconds to change the RF output channel (CH 03 or CH 04). "RF-03" or "RF-04" appears in the display window.

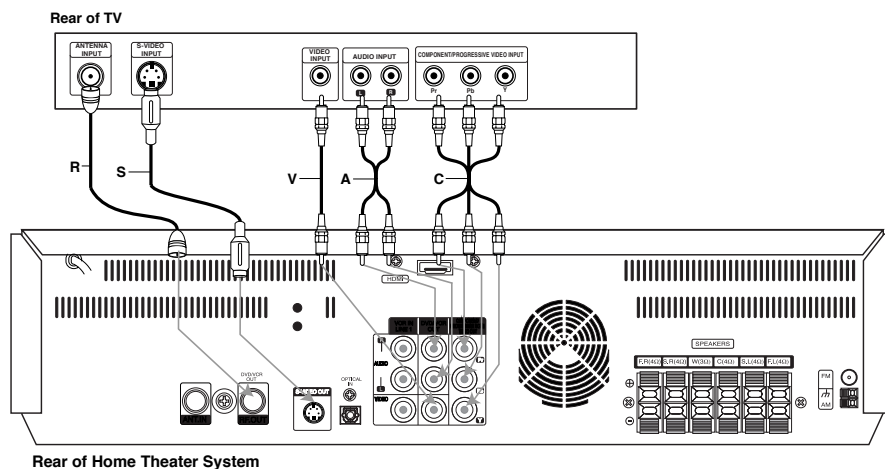

AUDIO/VIDEO CONNECTION

1. Connect the VIDEO OUT jack on the Home Theater System to the video in jack on the TV using the video cable (**V**).
2. Connect the Left and Right AUDIO OUT jacks from the Home Theater System to the audio left/right in jacks from the TV using the audio cables (**A**).

S-VIDEO CONNECTION

Connect the S-VIDEO OUT jack on the Home Theater System to the S-Video in jack on the TV using the S-Video cable (**S**).

Notes:

- For VIDEO OUT and S-VIDEO OUT jack connection, resolution must be set to 480i or 480p by pressing RESOLUTION on the remote control, however VIDEO OUT and S-VIDEO OUT is always at 480i standard resolution.
- HDMI mode must be set to OFF for VIDEO OUT and S-VIDEO OUT jack connection.

COMPONENT VIDEO (Color Stream®) CONNECTION

Connect the COMPONENT/PROGRESSIVE SCAN VIDEO OUT jacks on the Home Theater System to the corresponding in jacks on the TV using an Y Pb Pr cable (**C**).

PROGRESSIVE SCAN (ColorStream® pro) CONNECTION

- If your television is a high-definition or "digital ready" television, you may take advantage of the Combi Receiver's progressive scan output for the highest video resolution possible.
- If your TV does not accept the Progressive Scan format, the picture will appear scrambled if you try Progressive Scan on the Home Theater System.

Notes:

- You can change the resolution (480i, 480p, 720p, 1080i) for the component/progressive scan video output by pressing RESOLUTION on the remote control.
- For 720p and 1080i resolution, only non-copy protected discs can be played back. If the disc is copy protected, it will be displayed at the 480p resolution.
- HDMI mode must be set to OFF for Component video connections.
- Progressive scan does not work with the analog video connections (VIDEO OUT & S-VIDEO).

Antenna Connections

Connect the supplied FM/AM antenna for listening to the radio.

- Connect the AM Loop antenna to the AM antenna connector.
- Connect the FM Wire antenna to the FM antenna connector.

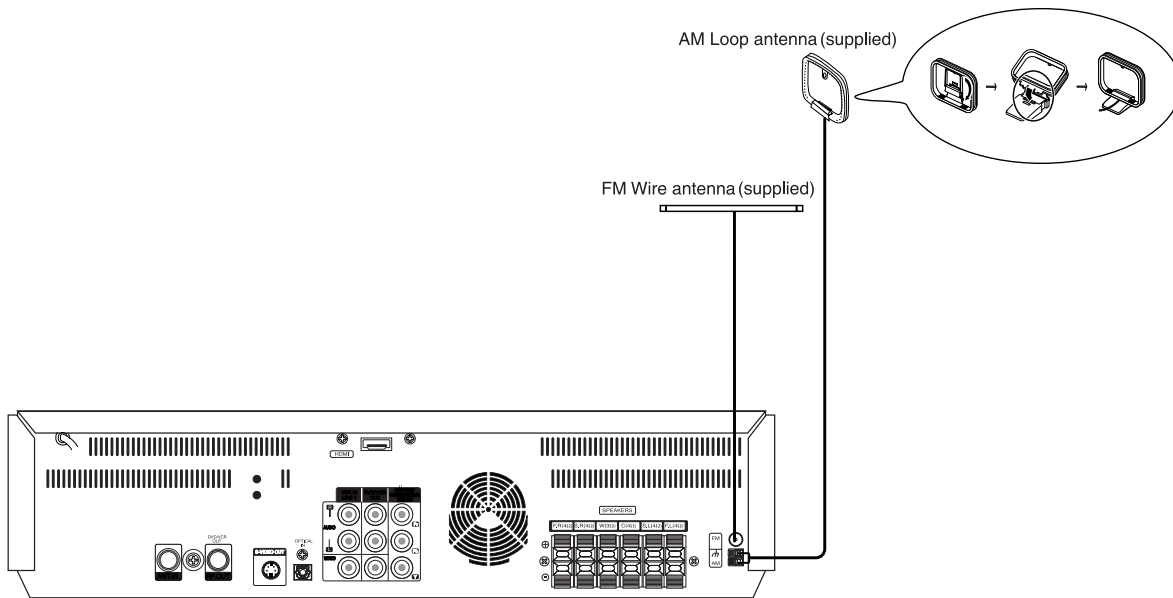

Notes:

- To prevent noise pickup, keep the AM Loop antenna away from the Combi Receiver and other components.
- Be sure to fully extend the FM wire antenna.
- After connecting the FM Wire antenna, keep it as horizontal as possible.

Accessory Audio/Video (A/V) Connections to Home Theater System

Connect the VCR IN LINE 1 or VIDEO/AUDIO(L/R) jacks on the Home Theater System to the AUDIO/VIDEO OUT jacks on your accessory component, using the optional audio/video cables.

If the auxiliary devices (e.g. DVD) are equipped with OPTICAL OUT jack, connect them to the OPTICAL IN jack of the Home Theater System.

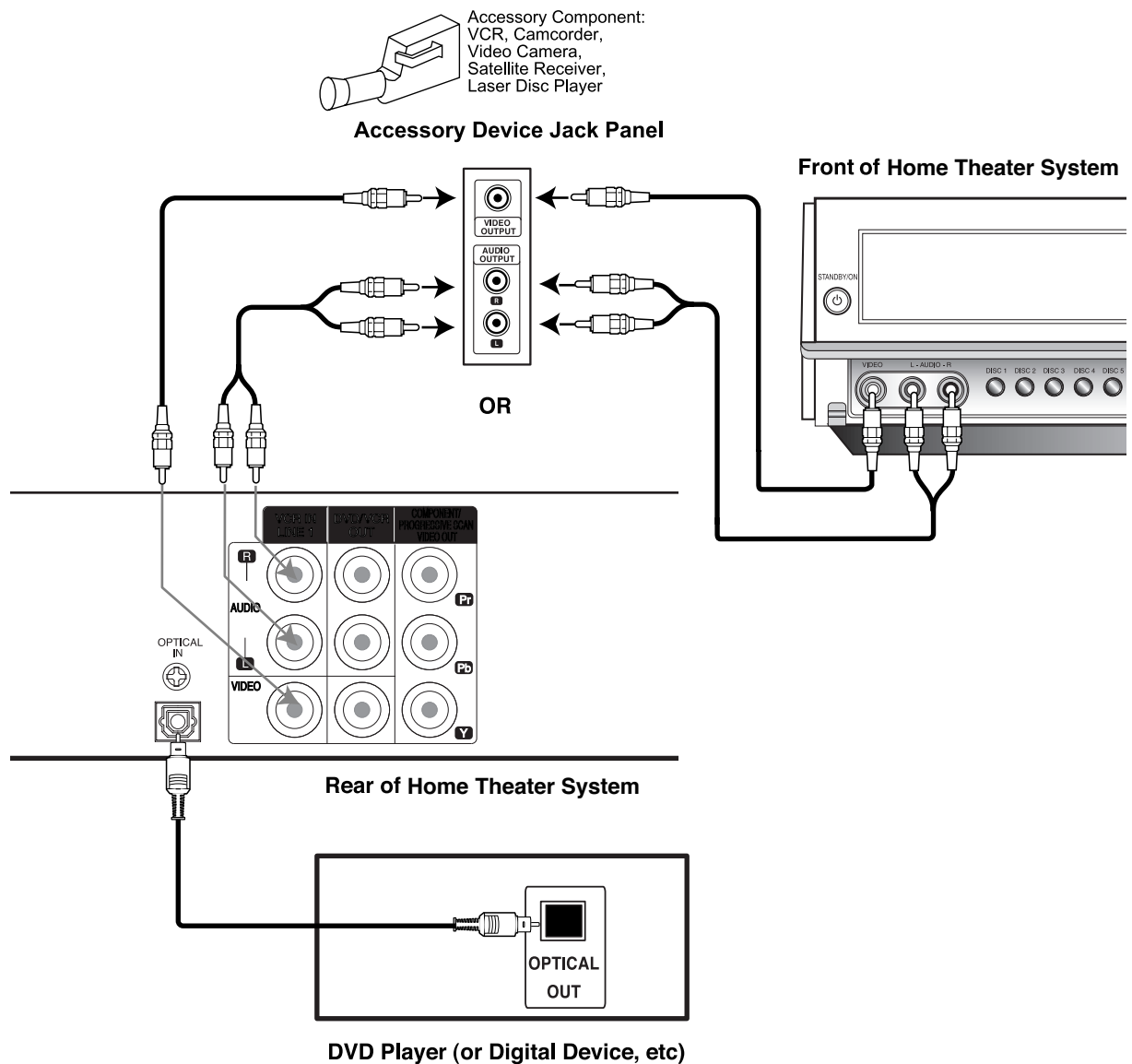

Note:

If you use the S-VIDEO IN jack on the front panel, the VIDEO jack on the front panel is not available.

HDMI Connection

If you have a HDMI TV or monitor, you can connect it to this Home Theater System using a HDMI cable.

1. Connect the HDMI OUT jack on the Home Theater System to the HDMI jack on a HDMI compatible TV or monitor (H).
2. Set the TV's source to HDMI (refer to TV's Owner's manual).
3. In stop mode, select HDMI mode by pressing HDMI on the remote control. Press RESOLUTION repeatedly to select the resolution you wish to change to then press PLAY. The DVD disc must not be playing in order to set the resolution.

Notes:

- No sound will be output from HDMI cable if the AUDIO setup is not set to PCM.
- The arrow on the cable connector body should face up for correct alignment with the connector on the Home Theater System.

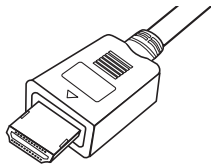

- When you use HDMI, the other connections (Yellow VIDEO OUT, S-Video and Component Video (Pr Pb Y)) will not work.
- If there is noise or lines on the screen, please check the HDMI cable.

Tip :

When you use HDMI connection, you can change the resolution (480p, 720p, 1080i) for the HDMI output by pressing RESOLUTION on the remote control. 480i is not available. You can only change the resolution within your TV's and Monitor's resolution capabilities.

- For S-VIDEO OUT connection, black and white scramble signal will appear if you select an incompatible resolution.

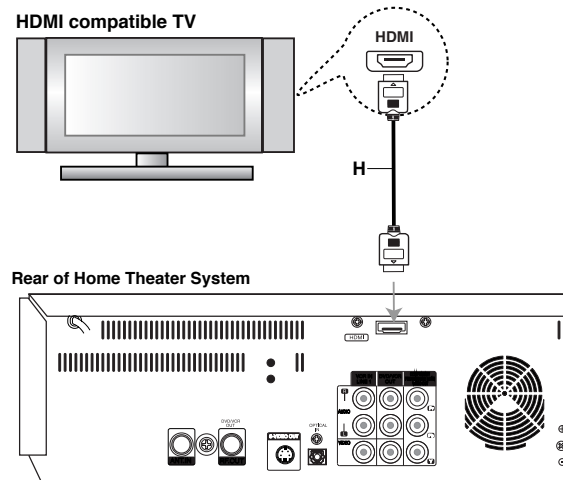

ABOUT HDMI

HDMI (High Definition Multimedia Interface) supports both video and audio on a single digital connection for use with DVD Players, Set-Top Boxes, and other AV devices.

HDMI was developed to provide the technologies of HDCP (High Definition Contents Protection). HDCP is used to protect digital content transmitted and received.

HDMI has the capability to support standard, enhanced, or high-definition video plus standard to multi-channel surround-sound audio, HDMI features include uncompressed digital video, a bandwidth of up to 5 gigabytes per second, one connector (instead of several cables and connectors), and communication between the AV source and AV devices such as DTVs.

HDMI, the HDMI logo and High-Definition Multimedia Interface are trademarks or registered trademarks of HDMI licensing LLC.

Speaker System Connection

Connect the speakers using the supplied speaker cables.

To obtain the best possible surround sound, adjust the speaker parameters (volume, distance, etc.).

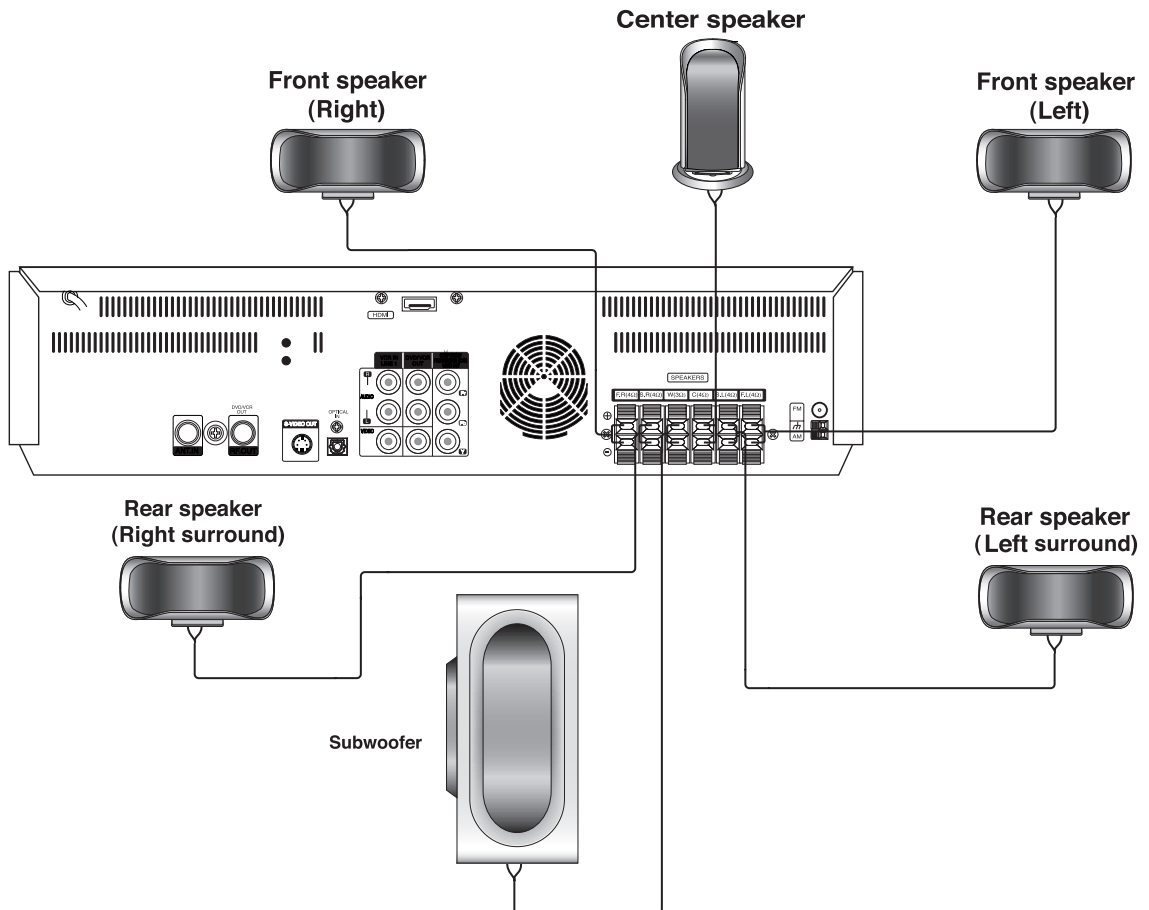

Notes:

- Be sure to match the speaker cable to the appropriate terminal on the components: + to + and – to –. If the cables are reversed, the sound will be distorted and will lack bass.
- If you use front speakers with low maximum input rating, adjust the volume carefully to avoid excessive output on the speakers.

Speaker Positioning

In the case of normal position use the 6 speakers (2 front speakers, 1 center speaker, 2 rear speakers and subwoofer).

If you want to play the excellent bass sound, DTS digital surround or Dolby Digital surround, you should connect a subwoofer.

- **Front speakers**

According to your listening position set up the speakers for equal distance. And by hearing position set up the interval between speakers to 45 degree.

- **Center speaker**

The center speakers and front speakers are ideally the same height, and placed above or below the television.

- **Rear speakers**

Place left and right behind the listening area. These speakers recreate sound motion and atmosphere required for surround sound playback. For best results, do not install the rear speakers too far behind the listening position and install them at or above the level of the listener's ears. It is also effective to direct the rear speakers towards a wall or ceiling to further disperse the sound.

In the case of a smaller room size, if the audience is near to the rear wall set the rear speakers opposite each other, and set the rear speakers above 60 - 90 cm than the listener's ears.

- **Subwoofer**

This can be placed in any front position.

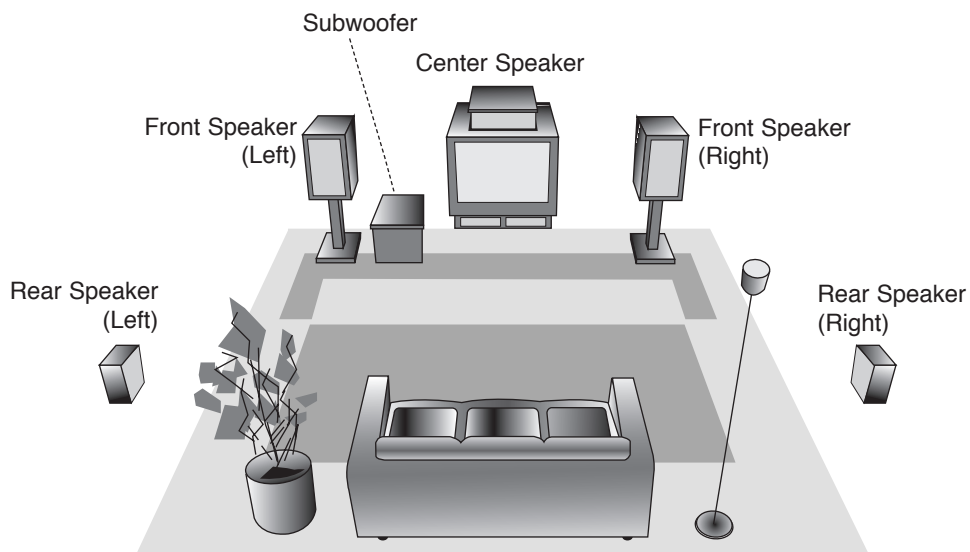

Speaker Positioning Example

Mini Glossary



Allows you to enjoy 5.1 (or 6) discrete channels of high quality digital audio from DTS program sources such as discs, DVD and compact discs, etc. bearing the trademark. DTS Digital Surround delivers up to 6 channels of transparent audio and results in exceptional clarity throughout a true 360 degree sound field. The term DTS is a trademark of DTS Technology, LLC. Manufactured under license from DTS Technology, LLC.

DIGITAL

The Dolby Digital surround format lets you enjoy up to 5.1 channels of digital surround sound from a Dolby Digital program source. If you play DVDs with “” mark, you can enjoy even better sound quality, greater spatial accuracy, and improved dynamic range.

PRO LOGIC

Use this mode when playing movie or Dolby Digital 2 channel which carries the “” mark. This mode provides the effect of being in a movie theatre or live concert house—an effect with an intensity which can only be obtained through DOLBY PRO LOGIC SURROUND. The effect of the front/back/left/right movement of the sound image, as well as the sense of fixed position in the sound image, is much clearer and more dynamic than before.

PRO LOGIC (II)

Dolby Pro Logic II creates five full-bandwidth output channels from two-channel sources. This is done using an advanced, high-purity matrix surround decoder that extracts the spatial properties of the original recording without adding any new sounds or tonal colorations.

MOVIE mode:

The Movie mode is for use with stereo television shows and all programs encoded in Dolby Surround. The result is enhanced soundfield directionality that approaches the quality of discrete 5.1-channel sound.

MUSIC mode:

The Music mode is for use with any stereo music recordings.

MATRIX mode:

The Matrix mode is the same as the Music mode except that the directional enhancement logic is turned off. It may be used to enhance mono signals by making them seem “larger.” The Matrix mode may also find use in auto systems, where the fluctuations from poor FM stereo reception can otherwise cause disturbing surround signals from a logic decoder. The ultimate “cure” for poor FM stereo reception may be simply to force the audio to mono.

3D SURROUND

This unit can produce a 3D Surround effect, using 3D Surround Sound technology, which simulates multi-channel audio playback from two conventional stereo speakers instead of the five or more speakers normally required to listen to multi-channel audio from a home theatre. This feature works with DVD discs encoded with Dolby Pro Logic and Dolby Digital audio tracks.

BYPASS

Software with multichannel surround audio signals is played according to the way it was recorded.

Sound Mode

You can enjoy surround sound simply by selecting one of the pre-programmed sound fields according to the program you want to listen to.

Each time you press the **SOUND MODE** button, the sound mode is changed in the following order;

PRO LOGIC → PLII MOVIE → PLII MUSIC → PLII MATRIX → ROCK → POP → LIVE → DANCE → TECHNO → CLASSIC → SOFT → 3D SURROUND → BYPASS ...

(This function available 2-channel mode only)

For DVD Operation

You can change the sound mode of DVD (Dolby Digital, DTS, PRO LOGIC, etc.) by pressing the **AUDIO** button repeatedly on the remote during playback. Although DVD contents differ from disc to disc, the following explains the basic operation when this feature is used.

Each time you press **AUDIO**, the Combi Receiver sound mode is changed in the following order;

DIGITAL → → → DIGITAL



For your reference

- **The Home Theater System memorizes the last mode setting for each source individually.**
- **You can identify the encoding format of program software by looking at its packaging.**
 - Dolby Digital discs are labeled with the logo.
 - Dolby Surround encoded programs are labeled with the logo.
 - DTS Digital Surround discs are marked with DTS.

Note:

- When you play sound tracks with 96kHz sampling frequency, the output signals will be converted to 48kHz (sampling frequency).

VCR Operation Setup

On-Screen Display (OSD)

Some of these functions appear during VCR operation.

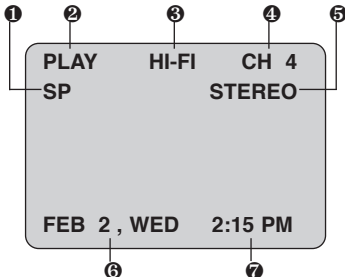

1 TAPE SPEED DISPLAY

Shows the current tape speed.

2 FUNCTION DISPLAY

Indicates the function in progress.

3 HI-FI DISPLAY

Indicates the unit is playing back tape recorded in Hi-Fi.

4 CHANNEL DISPLAY

Indicates the selected channel (or LINE1, LINE2).

5 STEREO/SAP DISPLAY (MONO is not displayed)

Shows the type of audio signal received by the VCR tuner.

6 DATE DISPLAY

Shows the current date. (Month/Date/Day of the week format)

7 CLOCK/COUNT/REMAIN DISPLAY

Shows the current time, the tape counter and remaining time on the tape.

Each press of **MEMORY/ENTER** changes the TV on-screen displays in the following sequence.

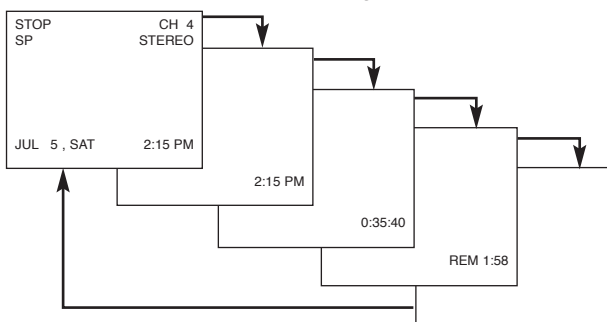

Notes:

- The function displays remain on the TV screen for 5 seconds.
- The clock (or tape counter, tape remaining) mode will continue to be shown until you press **MEMORY/ENTER**.
- The tape counter and the remaining tape length indicator appear only when a cassette is inserted. Also, the remaining tape length indicator appears after any tape operation.

EASY INFORMATION

If the Extended Data Service (XDS) signals are provided along with normal TV signal in your area or during playback of a tape recorded with Extended Data Service (XDS) signals, the station ID, program title, and program details are shown on the TV screen. When viewing a channel with Extended Data Service (XDS) signals, press **MEMORY/ENTER** and the station ID will appear on the TV screen. Press **MEMORY/ENTER** again and the program details will appear on the TV screen.

When viewing a tape recorded with Extended Data Service (XDS) signals, press **MEMORY/ENTER** twice and the program title and program details will appear on the TV screen.

PROGRAM DETAILS

LENGTH: Indicates the run length of a program.

TIME REMAINING: Indicates the remaining time of a program.

RATING: Indicates the rating of the current program (N/A, G, PG, PG-13, R, NC-17, X and Not Rated). The rating N/A means that the motion picture ratings are not applicable to this program.

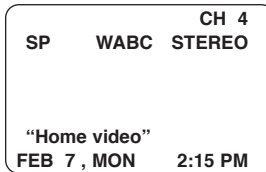

Easy Information Screen (Station ID)

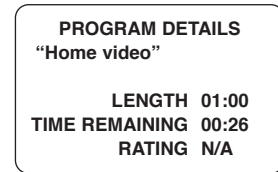

Easy Information Screen (Program details)

On-Screen Menu Setup

The SETUP, clock setting (CLOCK), and timer recordings (PROGRAM) functions are accessed conveniently with the on-screen menus, that lead you through each step. The following pages describe the on-screen menu selections available.

MENU SELECTION

Your VCR allows remote control adjustment of several features.

1. Press MENU and the MAIN menu will appear.
2. Select the desired menu with **▲/▼** button and then press **MEMORY/ENTER**.

Note:

Menus remain on-screen for 3 minutes.

MAIN MENU

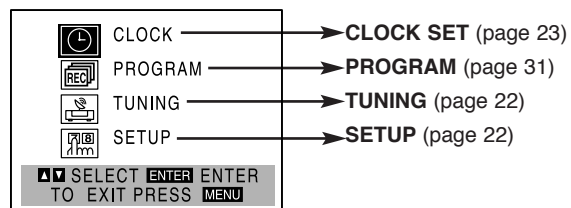

3. Press MENU when finished.

VCR Setup Menu Options

1. Press MENU and the MAIN menu will appear.
2. Use ▲/▼ to select the SETUP menu, then press MEMORY/ENTER.
The SETUP menu will appear.

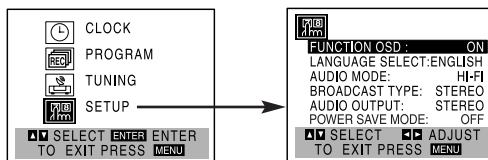

3. Use ▲/▼ to choose a desired option on the SETUP menu. Then use ◀/▶ to choose a desired setting.

FUNCTION OSD

The on-screen display of this Combi Receiver can be turned on or off.

- **FUNCTION OSD:** Choose ON and OFF with ◀/▶.

LANGUAGE SELECT

The on-screen programming of this Combi Receiver can be displayed in either English, Spanish, or French.

- **LANGUAGE SELECT:** Choose ENGLISH, SPANISH, or FRENCH with ◀/▶.

AUDIO MODE

The Home Theater System has two separate audio playback systems, the high quality VHS Hi-Fi system and standard NORMAL mono system. The same audio is generally recorded on both systems. The VHS Hi-Fi system plays on separate (left and right) channels, and the NORMAL system plays monaural sound. The normal track is always played so the cassette can be played on a Combi Receiver that does not have VHS Hi-Fi.

- **AUDIO MODE:** Choose Hi-Fi or NORMAL with ◀/▶.

BROADCAST TYPE (STEREO/SAP/MONO)

Multichannel Television Sound (MTS) carries stereo and/or Second Audio Program (SAP) bilingual signals. Set this display to the desired position when both MTS stereo and SAP signals are received. When only one of the MTS signal is received, the Combi Receiver automatically selects the corresponding receiving mode (Stereo or SAP) regardless of the selected position. For normal operation, the display should be in the STEREO position. The Combi Receiver will then record a STEREO program when available, and record a mono program IF the program is NOT IN STEREO.

For weak STEREO and/or SAP broadcasts, changing the display to mono may give clearer sound.

- **BROADCAST TYPE:** Choose STEREO, SAP, or MONO with ◀/▶.

AUDIO OUTPUT (STEREO/LEFT/RIGHT)

Used during playback [when AUDIO MODE (HI-FI/NORMAL) is in HI-FI position] for selecting the audio output signals from the AUDIO OUT terminals (L ch and R ch), and RF.OUT.

This display setting should normally be left in the stereo position, so that when a stereo tape is played, the stereo sound will be heard through the left and right channels. If a mono tape is played and the audio output is set to stereo, the same mono sound will be heard from both left and right channels.

- **AUDIO OUTPUT:** Choose STEREO, LEFT, or RIGHT with ◀/▶.

POWER SAVE MODE

Set POWER SAVE MODE to ON to your Home Theater System into an economic power saving mode.

- The display turns off when the unit is in standby mode.

4. Press MENU when finished.

Channel Selection

This Home Theater System is equipped with a frequency synthesized tuner capable of receiving up to 181 channels. These include VHF channels 2-13, UHF channels 14-69 and CATV channels 1-125.

Preparation:

- Connect the Home Theater System to the desired type of antenna or cable TV system, as shown in Connecting Antenna/Cable TV to Home Theater System on page 13.

AUTO CHANNEL PROGRAMMING

1. Press MENU and the MAIN menu will appear.
2. Use ▲/▼ to select the TUNING menu, then press MEMORY/ENTER.
The TUNING menu will appear.

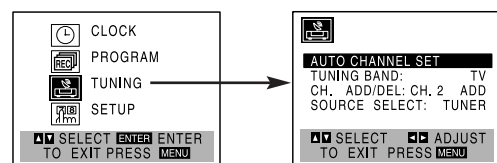

3. Use ▼ to choose the SOURCE SELECT option, then use ◀/▶ to select TUNER.
Press ◀/▶ repeatedly to switch among TUNER, LINE1 or LINE2.
4. Use ▲/▼ to choose the AUTO CHANNEL SET option, then use ◀/▶ to search for channels.
The tuner will automatically cycle through all available channels in the area and place them in the tuner's memory.
5. After the AUTO CHANNEL SET PROCEEDING is complete, make sure the TUNING BAND is set appropriately (TV or CATV). Choose the correct TUNING BAND (TV or CATV) with ◀/▶ while in the TUNING menu.
Remember, TV is for the air antenna reception, CATV is for cable or wireless cable connection.
6. Press MENU to return to the TV screen.
7. Use TRK/PRESET(-/+) (▲/▼) on the remote control to cycle the Home Theater System through the channels in memory.

TO ADD OR ERASE CHANNELS FROM MEMORY

This feature allows you to add or erase channels from memory manually.

- 1 Use ▼ to choose the CH. ADD/DEL option on the TUNING menu. Use ◀/▶ to select a channel to add or erase.
- 2 Use MEMORY/ENTER to add or erase the channel.
Repeat steps 1 and 2 to add or erase channels.
- 3 Press MENU to remove menu.

Setting the Clock

The Home Theater System gives you two ways to set the time and date: the Auto Clock Feature or manually. The Auto Clock feature enables the Home Theater System to set up the clock while the Home Theater System is turned off.

Things to know before starting

- The clock uses the 12-hour system. (Be sure to set AM and PM correctly.) (AM does not appear.)
- The initial Clock Setting is **JANUARY 1, 2005, 12:00 AM**.

AUTO CLOCK SET

The Auto Clock Set feature is set to ON at the factory. In the ON setting, the Combi Receiver looks for a channel carrying XDS (Extended Data Services) information. XDS updates the clock using the Coordinated Universal Time.

The Auto Clock feature enables the Combi Receiver to set up the clock while the Combi Receiver is turned off.

1. Press MENU and the MAIN menu will appear.
2. Use ▲/▼ to choose the CLOCK menu. Press MEMORY/ENTER and the CLOCK menu will appear.

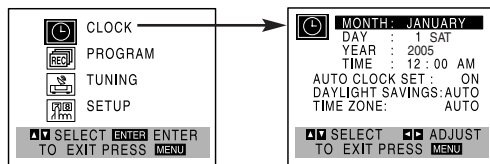

3. Use ▼ to choose the AUTO CLOCK SET option. Use ◀/▶ to choose ON. The Auto Clock Set feature is set to ON at the factory. In the ON setting, the Combi Receiver looks for a channel carrying XDS (Extended Data Services) information. XDS updates the clock using the Coordinated Universal Time.
4. Use ▼ to choose the DAYLIGHT SAVINGS option. Use ◀ or ▶ to choose AUTO, ON, or OFF. If you choose AUTO, the VCR sets the clock using the DST information broadcast in the signal (channel). If you choose ON, the VCR adjusts the clock for Daylight Saving Time automatically.
5. Use ▼ to choose the TIME ZONE option. Use ◀ or ▶ to choose the correct time zone (AUTO, EASTERN, CENTRAL, MOUNTAIN, PACIFIC, ALASKA or HAWAII). If "AUTO" is selected as the time zone, the VCR sets the clock using the first Coordinated Universal Time information it finds in a broadcast signal.
6. Press MENU when finished.
7. Turn off the Home Theater System and the auto clock set feature sets the time.

Note:

There are cases where the TV station does not send or sends wrong date and/or time information and the Home Theater System sets the incorrect time.

If this happens we recommend that you set the clock manually.

MANUAL CLOCK SET

1. Press MENU and the MAIN menu will appear.
2. Use ▲/▼ to choose the CLOCK menu. Press MEMORY/ENTER and the CLOCK menu will appear.

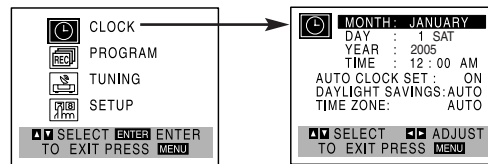

3. Use ◀/▶ to choose the month.
4. Use ▼ to choose the DAY option. Use ◀/▶ to choose the date. The day of the week will display automatically.
5. Use ▼ to choose the YEAR option. Use ◀/▶ to choose the year.
6. Use ▼ to choose the TIME option. Use ◀/▶ to choose the time. Press and hold ◀/▶ to advance clock continuously.
7. Use ▼ to choose the DAYLIGHT SAVINGS option. Use ◀ or ▶ to choose AUTO, ON, or OFF. If you choose AUTO, the VCR sets the clock using the DST information broadcast in the signal (channel). If you choose ON, the VCR adjusts the clock for Daylight Saving Time automatically.

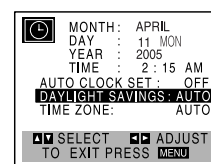

8. Press MENU when finished.

Note:

If setting the clock manually, "AUTO CLOCK SET" must set to "OFF".

If set to "ON", an incorrect date and/or time will be entered again when the Home Theater System is turned off.

DVD Operation Setup

On-Screen Display

You can display the general playback status on the TV screen. Some items can be changed using the menu.







To use the on-screen display:

1. Press DISPLAY during playback.
2. Press ▲ / ▼ to select an item. The selected item is highlighted.
3. Press ◀ / ▶ to change the setting. You can also use the number buttons if appropriate (e.g. inputting the title number). For some functions, press ENTER to execute the setting.







Notes:

- Some discs may not provide all of the features shown below.
- If no button is pressed for 10 seconds, the on-screen display disappears.

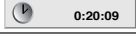
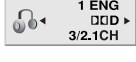

PLAYBACK STATUS/RESTRICTIONS

	Title	Repeat title
	A - B	Repeat sequence
	1 / 9	Enter a Marker
	MARKER SEARCH	Marker Search menu
		Resume play from this point
		Action prohibited or not available



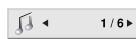
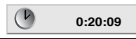
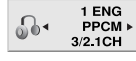

Example: On-Screen Display during playing DVD Video

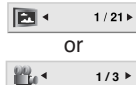
Items	Selection Method
Title Number 	◀ / ▶, Numbers ENTER
Chapter Number 	◀ / ▶, Numbers ENTER
Time search 	Numbers, ENTER
Audio language and Digital Audio Output mode 	◀ / ▶ or AUDIO
Subtitle language 	◀ / ▶ or SUBTITLE
Angle 	◀ / ▶ or ANGLE
Sound 	◀ / ▶

Example: On-Screen Display during playing DVD Audio

Items	Selection Method
Group Number 	◀ / ▶, Numbers ENTER
Track Number 	◀ / ▶, Numbers ENTER
Time search 	Display only
Audio language and Digital Audio Output mode 	◀ / ▶ or AUDIO
Subtitle language 	Display only
Page (or Angle) 	◀ / ▶ or ANGLE

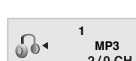
Example: On-Screen Display during playing divx movie disc

Items	Selection Method
Track Number 	◀ / ▶, Numbers ENTER
Time search 	Numbers, ENTER
Audio language and Digital Audio Output mode 	◀ / ▶ or AUDIO
Subtitle language 	◀ / ▶ or SUBTITLE
Sound 	◀ / ▶

Initial Settings

By using the Setup menu, you can make various adjustments to items such as picture and sound. You can also set a language for the subtitles and the Setup menu, among other things. For details on each Setup menu item, see pages 25 to 28.

To display and exit the Menu:

Press **SETUP** to display the menu. A second press of **SETUP** will take you back to initial screen.

To go to the next level:

Press **▶** on the Remote Control.

To go back to the previous level:

Press **◀** on the Remote Control.

General Operation

1. Press **SETUP**. The Setup menu appears.
2. Use **▲ / ▼** to select the desired option then press **▶** to move to the second level. The screen shows the current setting for the selected item, as well as alternate setting(s).
3. Use **▲ / ▼** to select the second desired option then press **▶** to move to the third level.
4. Use **▲ / ▼** to select the desired setting then press **ENTER** to confirm your selection. Some items require additional steps.
5. Press **SETUP** or **PLAY** to exit the Setup menu.

Language

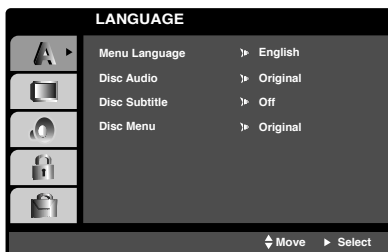

MENU LANGUAGE

Select a language for the Setup menu and on-screen display.

DISC AUDIO / SUBTITLE / MENU **DVD-V** **DVD-A**

Select the language you prefer for the audio track (disc audio), subtitles, and the disc menu.

Original: Refers to the original language in which the disc was recorded.

Other: To select another language, press number buttons then **ENTER** to enter the corresponding 4-digit number according to the language code list in the reference chapter. If you enter the wrong language code, press **CLEAR**.

Display

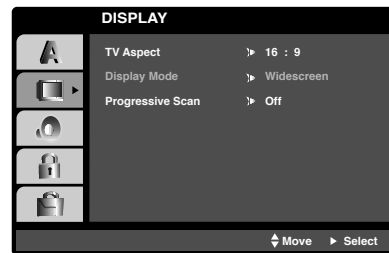

TV ASPECT **DVD-V** **DVD-A**

4:3: Select when a standard 4:3 TV is connected.

16:9 Wide: Select when a 16:9 wide TV is connected.

DISPLAY MODE **DVD-V** **DVD-A**

Display Mode setting works only when the TV Aspect mode is set to "4:3".

Letterbox: Displays a wide picture with bands on the upper and lower portions of the screen.

Panscan: Automatically displays the wide picture on the entire screen and cuts off the portions that do not fit.

PROGRESSIVE SCAN

Progressive Scan Video provides the highest quality pictures with less flickering.

If you are using the Component Video jacks for connection to a TV or monitor that is compatible with a progressive scan signal, set Progressive Scan to On.

To Turn ON progressive scan:

Connect component out of the DVD to the input of your monitor/television, set your television or monitor to Component Input.

1. Select "Progressive Scan" on the DISPLAY menu then press **▶**.

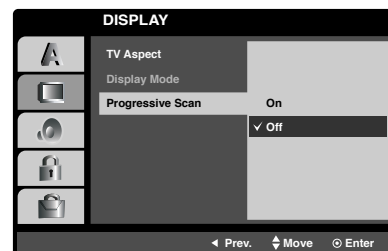

2. Select "On" using the **▲ / ▼** buttons.

3. Press **ENTER** to confirm your selection. The confirm menu will appear.

Note:

- If your TV does not accept the Progressive Scan format, the picture will appear scrambled if you try Progressive Scan on the Home Theater System .
4. When the confirm menu appears on your screen Cancel is highlighted as default. Use the ◀ / ▶ buttons to highlight Enter.
 5. Pressing ENTER will set the receiver to Progressive scan mode.

Caution:

Once the setting for progressive scan output is entered, an image will only be visible on a progressive scan compatible TV or monitor. If you set Progressive Scan to On in error, you must reset the unit. First, remove the disc in the Home Theater System. Next, press STOP (■) and hold it for five seconds before releasing it. The video output will be restored to the standard setting, and a picture will once again be visible on a conventional analog TV or monitor.

Audio

Each DVD disc has a variety of audio output options. Set the receiver's AUDIO options according to the type of audio system you use.

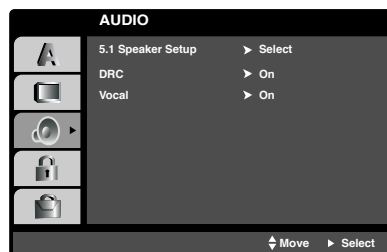

5.1 SPEAKER SETUP **DVD-V** **DVD-A**

Select speaker settings, including volume balance and distance, or test the speaker settings. Speaker settings are only active on the Analog Multi-Channel Output. (See "5.1 Speaker Setup", page 33.)

DYNAMIC RANGE CONTROL (DRC)

DVD-V **DVD-A**

With the DVD*1 format, you can hear a program's soundtrack in the most accurate and realistic presentation possible, thanks to digital audio technology. However, you may wish to compress the dynamic range of the audio output (the difference between the loudest sounds and the quietest ones). Then, you may listen to a movie at a lower volume without losing clarity of sound. Set DRC to On for this effect.

*1: Dolby Digital only

VOCAL **DVD-V**

Set Vocal to On only when a multi-channel karaoke DVD is playing. The karaoke channels on the disc will mix into normal stereo sound.

Lock (Parental Control)

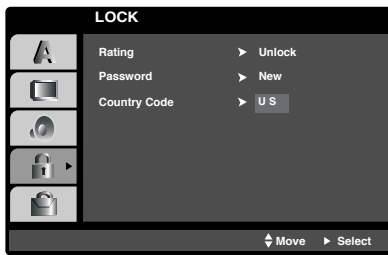

RATING DVD-V

Some movies contain scenes that may not be suitable for children to view. Many of these discs contain parental control information that applies to the complete disc or to certain scenes on the disc. Movies and scenes are rated from 1 to 8, depending on the country. Some discs offer more suitable scenes as an alternative.

The parental control feature allows you to block access to scenes below the rating you input, thereby preventing your children from being able to view material you believe is unsuitable.

1. Select "Rating" on the LOCK menu then press ►.
2. To access the Rating, Password and Country Code features, you must input the 4-digit security code you created. If you have not yet entered a security code you are prompted to do so.

Input a 4-digit code and press ENTER. Enter it again and press ENTER to verify. If you make a mistake before pressing ENTER, press CLEAR.

3. Select a rating from 1 to 8 using the ▲ / ▼ buttons.

Rating 1-8: Rating one (1) has the most restrictions and rating eight (8) is the least restrictive.

Unlock

If you select unlock, parental control is not active and the disc plays in full.

Notes:

If you set a rating for the receiver, all disc scenes with the same rating or lower are played. Higher rated scenes are not played unless an alternate scene is available on the disc. The alternative must have the same rating or a lower one. If no suitable alternative is found, playback stops. You must enter the 4-digit password or change the rating level in order to play the disc.

4. Press ENTER to confirm your rating selection, then press SETUP to exit the menu.

PASSWORD (SECURITY CODE)

You can enter or change password.

1. Select Password on the LOCK menu then press ►.
2. Follow step 2 as shown left (Rating). "Change" or "New" is highlighted.
3. Enter the new 4-digit code, then press ENTER. Input it again to verify.
4. Press SETUP to exit the menu.

If you forget your Security Code

If you forget your security code you can clear it using the following steps:

1. Press SETUP to display the Setup menu.
2. Input the 6-digit number "210499" and the security code is cleared.
3. Enter a new code as described above.

COUNTRY CODE DVD-V

Enter the code of the country/area whose standards were used to rate the DVD video disc, based on the list in the reference chapter.

1. Select "Country Code" on the LOCK menu then press ►.
2. Follow step 2 as shown left (Rating).
3. Select the first character using ▲ / ▼ buttons.
4. Press ENTER and select the second character using ▲ / ▼ buttons.
5. Press ENTER to confirm your country code selection.

Others

The Auto Play, B.L.E. and DivX(R) VOD settings can be changed.

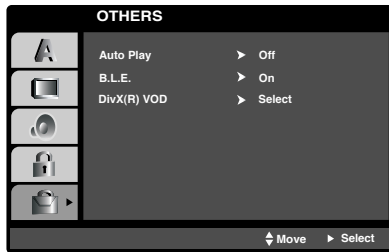

AUTO PLAY **DVD-V**

You can set up the Home Theater System so a DVD disc automatically starts playing whenever the DVD is inserted.

If Auto Play mode is set to On, this Home Theater System will search for title that has the longest playback time and then play back the title automatically.

On: Auto Play function is active.

Off: Auto Play function is not active.

Note:

- The Auto Play function may not work for some DVDs.

B.L.E. (BLACK LEVEL EXPANSION)

To select the black level of playback pictures. Set your preference and monitor's ability.

On: Expanded grey scale. (0 IRE cut off)

Off: Standard grey scale. (7.5 IRE cut off)

DIVX(R) VOD **DivX**

You can show the DivX DRM (Digital Right Management) Registration code for your unit only.

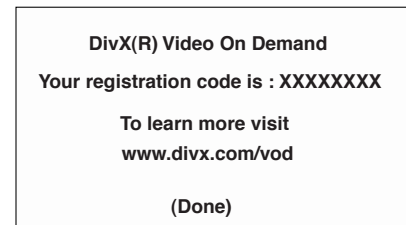

The Registration code is used for VOD (Video-On-Demand) service agent. You can purchase or rent an encrypt move file.

Notes:

If you rent the DivX VOD file, it has several options of viewing limits as shown below.

- Display the number which you can watch the file.

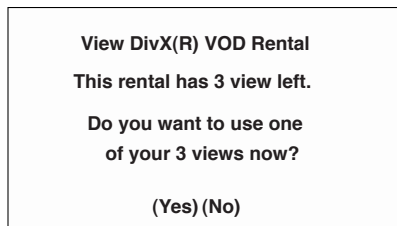

- The rental has been expired.

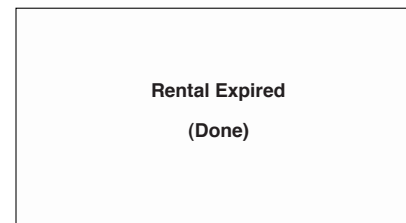

- Display the authorization error.

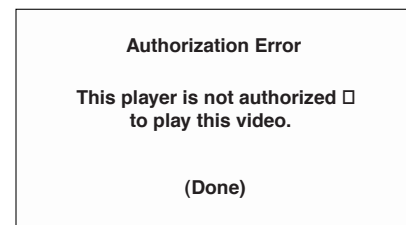

VCR Operation

Normal Playback

Preparation:

- Turn on the TV.
- Tune the TV to the Combi Receiver output channel (CH 3 or 4) or set the TV's source selector to VIDEO.
- If a direct VIDEO connection is made between the Combi Receiver and the TV, set the TV's source selector to VIDEO.
- Set the Output Source to VCR as shown in Setting the Output Source on page 6.

1. Insert a prerecorded video cassette.

The  indicator will light and the Combi Receiver will power-up automatically.

- Make sure that the  indicator in the display window is not lighted. If it is, press POWER once.
- If a tape without a safety tab is inserted, the unit will start playback automatically.

2. Press PLAY (▶) once.

PLAY appears on the TV screen .

- It is not necessary to select the tape speed for playback. It will be automatically selected by the Combi Receiver.
- In playback, the TV/VCR selector switches to VCR mode automatically.

3. Press STOP (■) to stop playback.

STOP appears on the TV screen.

- If the tape reaches the end before STOP (■) is pressed, the Combi Receiver will automatically stop, rewind and eject the tape, and it will turn itself off.

Tracking Control



AUTO TRACKING

The automatic tracking function adjusts the picture to remove snow or streaks.

The AUTO TRACKING function works in the following cases:

- A tape is played back for the first time.
- Tape speed (SP, LP, SLP) changes.
- Streaks or snow appear because of scratches on the tape.

MANUAL TRACKING

If noise appears on the screen during playback, press either **TRK/PRESET (-/+)**   on the remote control until the noise on the screen is reduced.

- If vertical jitter is present, adjust tracking controls very carefully.
- Tracking is automatically reset to normal when the tape is ejected or the power cord is unplugged for more than 3 seconds.

Note:

- Only 2-channel stereo (Front Left, Front Right & Subwoofer) is available for VCR mode, thus sound might not be heard from center or rear speakers during VCR playback. (For further details about sound mode, please refer to page 20)

Special Effect Playbacks

Notes:

- Horizontal lines (noise bars) will appear on the TV screen. This is normal.
- The audio is automatically muted during special effect modes, so there is no sound during search.
- During high-speed picture search mode, a short period is needed to stabilize tape speed when re-entering the PLAY mode. Slight interference may be observed during this period.

Search

This function lets you quickly and visually search for a desired tape section in either direction: forward or reverse.

1. Press BACKWARD (◀◀) or FORWARD (▶▶) during playback.

The Home Theater System will be activated in the SEARCH mode.



- If the Home Theater System is left in the SEARCH mode for more than 3 minutes, the Home Theater System will automatically enter the PLAY mode, to protect the tape and video heads.

2. To return to playback, press PLAY (▶).

Still Picture & Frame-by-Frame Playback

1. Press PAUSE/STEP (||) during playback.

Picture movement will stop on one frame.

- If the still picture vibrates vertically, stabilize it using   on the remote control.
- If the Combi Receiver is left in the STILL mode for more than 5 minutes, the Combi Receiver will automatically enter the STOP mode to protect the tape and video heads.



2. Press PAUSE/STEP (||) repeatedly to advance the video one frame at a time while viewing a still picture in Still mode.

3. To return to playback, press PLAY (▶).

Slow Motion

1. While in Still mode, press FORWARD (▶▶).

The tape will be played back at a speed 1/19 times slower than the normal speed.

- During slow playback, use   on the Remote Control to minimize noise bands.
- If slow motion mode continues for more than 3 minutes, the Home Theater System will automatically change to playback mode.

2. To return to playback, press PLAY (▶).

CM Skip (Commercial Skip)

This is useful for skipping commercials or short program segments.

1. Press CM SKIP during playback.

The tape will fast forward picture search through 30 seconds of recording.

- Skipping time can be extended by pressing **CM SKIP** repeatedly.
- Subsequent presses result in advancing the fast forward picture search time by 30-second increments (maximum 3 minutes).

2. When the search is complete, the Home Theater System will go into playback mode automatically.

Normal Recording

Preparation:

- Turn on the power of both the Home Theater System and TV.
- Tune the TV to the Home Theater System output channel (CH 3 or 4) or set the TV's source selector to VIDEO.
- If a direct VIDEO/AUDIO connection is made between the Home Theater System and the TV, set the TV's source selector to VIDEO.

1. Insert a video cassette with the anti erasure safety tab intact.
2. Select the desired channel with ▲/▼.
 - If you are recording from another source via audio/video input jacks (at the Rear or Front panel), select LINE1 or LINE2 with INPUT.
3. Set the desired recording speed (SP or SLP) with SPEED.
 - This Combi Receiver is not designed to record in LP mode.
4. Set the MTS mode as desired (See page 22, 23).
5. Press REC/ITR (●) once.
Recording will start. (The REC indicator will light in the display window.)
 - REC indicator appears only when the Output Source is set to VCR.
 - If a cassette with no anti erasure safety tab is loaded, the cassette will be ejected automatically.
6. Press STOP (■) twice to stop recording.
If the tape reaches the end before STOP (■) is pressed, the Home Theater System will automatically stop, rewind, eject the tape and turn itself off.

Pausing the recording

1. Press PAUSE/STEP (||) to pause the tape during recording.
The REC indicator will flash in the display window.
2. When you want to continue recording, press PAUSE/STEP (||) or REC/ITR (●).
 - After 5 minutes in Pause mode, the tape will be stopped automatically to protect the tape and the video heads.

To record one TV program while watching another

1. Use TV/VCR to select the TV mode while recording.
The TV indicator appears.
2. Using the TV, select the channel to be viewed.

Tip:

Always use PAUSE/STEP (||) for best results when making changes while recording.
For example: To change channels while recording, first press PAUSE/STEP (||) to put the unit in pause mode. Select the desired channel on the Home Theater System, then press PAUSE/STEP (||) again to resume recording.

Timer Recording

This Home Theater System can be programmed to record up to 8 programs within a period of 1 year. For unattended recording, the timer needs to know the channels to be recorded and the starting and ending times.

Things to know before starting

- If you try to set the program timer before setting the clock, PLEASE SET THE CLOCK appears for a moment and then CLOCK menu appears on the TV screen. Set the time and date before proceeding.
- Make sure a tape is in the Combi Receiver and the anti erasure safety tab is in place or the tape will be automatically ejected.

Preparation:

- Turn on the power of both the Home Theater System and the TV.
- Be sure the TV is set to the Home Theater System output channel (3 or 4).
- Make sure the TUNING BAND in the TUNING menu is set appropriately (TV or CATV).

1. Press MENU and the MAIN menu will appear.
2. Use ▲/▼ to choose the PROGRAM menu.
3. Press MEMORY/ENTER to go to the PROGRAM menu.
The PROGRAM menu will appear.
 - If all 8 programs have been entered, FULLY PROGRAMMED message will appear for a moment and then PROGRAM 1 will appear on the TV screen.

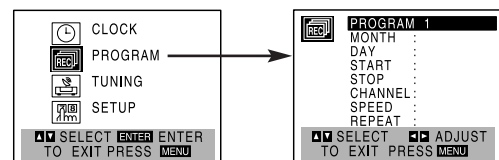

4. Use ◀/▶ to choose the PROGRAM No. (1-8).
5. Use ▼ to choose the MONTH option.
Use ◀/▶ to choose the desired month.
6. Use ▼ to choose the DAY option.
Use ◀/▶ to choose the desired day.
7. Use ▼ to choose the START option.
Use ◀/▶ to choose the desired start time.
8. Use ▼ to choose the STOP option.
Use ◀/▶ to choose the desired stop time.
9. Use ▼ to choose the CHANNEL option.
Use ◀/▶ to choose the desired channel (Channel, LINE1 or LINE2).

Cable Users: If you have CABLE TV and used Cable Box in Connecting Antenna/Cable TV to Home Theater System (page 11), using a cable box converter, you must set the channel in this step to match the cable box output channel (usually CH 3 or 4). Change channels on the cable box instead of with the Home Theater System.

10. Use ▼ to choose the SPEED option.
Use ◀/▶ to choose the desired recording speed (AUTO, SP or SLP).
 - AUTO mode determines how much tape is left and switches speed from SP to SLP, if necessary, to complete recording the program. There will be some picture and sound distortion at the point of the speed change.
11. Use ▼ to choose the REPEAT option.
Use ◀/▶ to choose the desired repeat (ONCE, WEEKLY or DAILY).

ONCE event....for recording up to 8 programs on a single day or over the days within a period of 1 year.

WEEKLY event....for recording up to 8 programs on a certain day of every week.

DAILY event....for recording up to 8 programs at the same time(s) Monday through Friday.

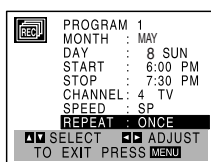

Tip:

If the input data is wrong, use ▲ to select the data and correct it using ◀/▶.

12. Press MENU, the program will be memorized by the Home Theater System.
 - Ⓞ indicator lights in the display window.
 - If the program preset time has past, the PAST TIME PROGRAMMED message will appear on the TV screen. Return to the incorrect program and program it with the correct time.
 - If you had entered a past date, timer recording will be performed on that date of the next year.
 - Additional programs may be entered by repeating steps 1-12.

Cable Users: If your cable hookup is via a TV converter box, you can program multiple recordings only on the converter box output channel. This is because the converter determines what channel you view through your Home Theater System.

Tip:

If you are finished programming and you want to set the Home Theater System to record the programs you have entered, **MAKE SURE YOU HAVE INSERTED A TAPE INTO THE HOME THEATER SYSTEM.** The Home Theater System is now set to record the preset programs.

After setting up a timer recording, recording will start if no other timer recordings overlap the start time, see next column.

Notes:

- If the power fails or the Home Theater System is unplugged from the AC outlet, the correct clock time and timer settings are kept in memory for approximately 3 seconds. After 3 seconds, the clock and program timer must be reset when power is restored. Reset the clock according to instructions.
- After timer recording is completed, the Home Theater System will turn off automatically.
- To watch a TV program while timer recording is in progress, select Tuner mode by pressing TV/VCR repeatedly.
- If you wish to stop timer recording which has already started, press STOP or POWER twice.

Checking (Erasing) Timer Record Programming

Programming can be checked whenever the Home Theater System is turned on.

1. Press MENU and the MAIN menu will appear.
2. Use ▲/▼ to choose the PROGRAM menu.
Press MEMORY/ENTER and the PROGRAM menu will appear.

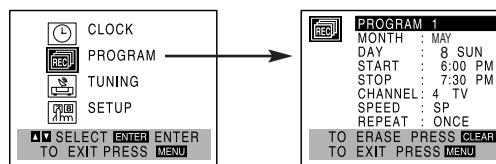

3. Use ◀/▶ to select a program you want to check or erase. If you want to erase the program, press CLEAR.
4. Press MENU to return to the TV screen.

Program Priority

If the recording start and end times of preset programs overlap on the same day (see the example and diagram left), program number 2 will not be recorded until program number 1 is finished.

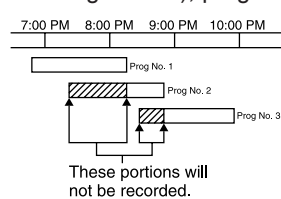

The first part of program number 2 will not be recorded. The same thing will happen to program number 3.

Instant Timer Recording

Instant Timer Recording allows you to make a recording easily of a preset length without using the programmable timer.

Preparation:

- Turn on the power of both the Home Theater System and the TV.
- Be sure the TV is tuned to the Home Theater System output channel (3 or 4).
- If a direct VIDEO/AUDIO connection is made between the Home Theater System and the TV, set the TV's source selector to VIDEO.

1. Insert a video cassette with the anti erasure safety tab intact.
2. Select the desired channel with ▲/▼ or number (0-9).

The channel number appears on the TV screen.

- If you are recording from another source via audio/video input jacks (at the Rear or Front panel), select LINE1 or LINE2. with **INPUT**.
3. Select the desired recording speed (SP or SLP) with **SPEED**.

The tape speed will appear on the TV screen.

4. Press **REC/ITR** (●) twice.
The menu as illustrated, will appear on the TV screen.
- Recording will start. (The ☺ indicator will light)

5. Press **REC/ITR** (●) repeatedly to select the recording time length.

At the end of the recording, the Home Theater System will stop recording and shut off.

- While Instant Timer Recording is active, changing the channel on the Home Theater System will not be possible.
- To stop the recording, press **STOP** or **POWER** twice.

INSTANT TIMER RECORD	
CHANNEL	2
SPEED	SP
START LENGTH	NOW 0H30M

0H30M 9H00M → 0H00M
↑
Length Display
(each additional press of
REC/ITR (●) increases recording
time 30 minutes)

Checking the Recording Time

Press **REC/ITR** (●) once to check the recording time. The recalled setting will automatically return to the TV screen after 6 seconds.

To extend the Recording Time

The recording time can be extended anytime by pressing **REC/ITR** (●).

Subsequent presses result in advancing the recording time by 30-minute increments.

Notes:

- If you press **PAUSE/STEP** (||) while in instant timer recording mode, the Home Theater System will enter the recording pause mode. Instant timer recording is cancelled.
- If the Home Theater System is set to "0H00M", the Home Theater System goes to normal recording mode.

Dubbing and Editing

If you wish to edit or dub your camcorder (or another VCR) recordings to this Home Theater System, the rear (or Front) panel mounted Audio and Video (A/V) input jacks make the connections quick and easy. These direct A/V jacks will also provide better picture results than using the RF jack on the rear panel.

1. **Connect the camcorder's (or another VCR's) A/V outputs to your Home Theater System as illustrated on page 14.**
2. Set the input channel "LINE2". (Use **INPUT** to select LINE2.)
 - If you have connected your Home Theater System to the A/V input jacks on the rear of Home Theater System, you should select the input channel LINE1 by pressing **INPUT** twice.
3. Play the tape in the camcorder (or another VCR). If you have a TV attached to your Home Theater System, you can see the video playing.
4. When you desire the recording to begin, press Home Theater System's **REC/ITR** (●) once to start.

Notes:

- Before recording, please confirm the recording start position.
- To stop the editing, press **STOP** (■) twice.

Copying from DVD to VCR

This unit is capable of copying the contents of a DVD to a VHS tape.

Note:

If the DVD you are attempting to copy is copy protected, you will not be able to copy the disc. It is not permitted to copy Macrovision encoded DVDs. "LOCK" is displayed in the display window.

1. **Insert Disc**
Insert the disc you wish to copy in the DVD deck and close the disc tray.
2. **Insert VHS Tape**
Insert a blank VHS video tape into the VCR deck.
3. Press **PLAY** (▶) on the DVD deck.
The DVD will go into play mode
 - If the DVD disc menu appears, you may need to press **PLAY** (▶) manually to begin copying.
4. Press **REC/ITR** (●) on the front panel or remote control.
 - The Home Theater System will go into Record mode.
 - "COPY" indicator will light.
5. **Stop the Copy Process**
When the DVD is finished playing, press **STOP** (■) or **POWER** twice to end copying.
You must stop the Copy process manually when the DVD movie ends, or the unit may replay and record over and over again.

Note:

When you stop the DVD playback during copying, VCR recording mode also stops automatically.

VHS Hi-Fi Stereo System/ MTS Broadcast

This Home Theater System is equipped with the VHS Hi-Fi audio sound system for recording and playback. The information below gives a brief description of Hi-Fi audio and how to record and play a tape in the Hi-Fi audio mode.

1. Set the AUDIO MODE option to Hi-Fi on the SETUP menu .

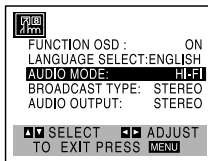

2. Set the AUDIO OUTPUT option to STEREO position.

- (STEREO) POSITION:** The left channel sound (L) is heard from the left speaker and the right channel sound (R) is heard from the right speaker.
- (LEFT) POSITION:** The left channel sound (L) is heard from both speakers.
- (RIGHT) POSITION:** The right channel sound (R) is heard from both speakers.

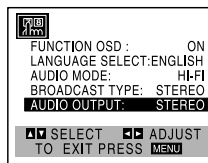

3. Press MENU.
4. Insert a cassette and press PLAY (▶).
Adjust volume at your stereo system.

MTS (Multichannel TV Sound)

This Home Theater System will decode MTS stereo and bilingual (SAP) off-the-air broadcast sound signals. It also decodes stereo TV sound from local cable companies, as long as they operate on assigned cable frequencies and use the EIA-recommended MTS stereo/bilingual TV sound system.

Multichannel TV Sound Indicator

Shows onscreen as illustrated below when **MEMORY/ENTER** is pressed.

- One or both of the indicators will light, depending on the MTS broadcast.

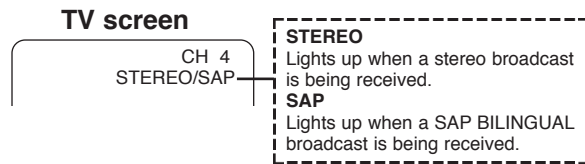

If only STEREO appears on the TV screen.

The Home Theater System can record in stereo onto the VHS Hi-Fi audio tracks when the BROADCAST TYPE option is in the STEREO position. The Home Theater System will also record mono audio onto the mono audio track.

If only SAP appears on the TV screen.

Set the BROADCAST TYPE option to SAP.

If STEREO/SAP appears on the TV screen

Use the BROADCAST TYPE option to select the desired recording mode (STEREO or SAP).

SAP (Second Audio Program) Recording

Some stations transmit a Second Audio Program, which is used for a second language or additional information. When the station broadcasts a Second Audio Program, follow the procedure below to record the SAP.

1. Insert a video cassette with the anti erasure safety tab intact.
2. Set the BROADCAST TYPE option to SAP (SETUP menu).
Do this if only the SAP appears on the TV screen or you know the program will use the SAP.

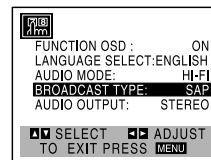

3. Press MENU.
4. Select the desired recording speed (SP or SLP) with SPEED.
5. Select the desired channel. SAP should appear on the TV screen.
6. Press REC/ITR (●) once
You are now recording the program you see and hear on the TV.
7. Press STOP (■) twice to stop recording.

Tape Counter Memory Feature

Real-Time Counter

Shows length of tape run in hours, minutes, and seconds. Press **CLK/CNT** to select the real-time counter display.

Every press of **CLK/CNT** changes the TV screen display as illustrated below.

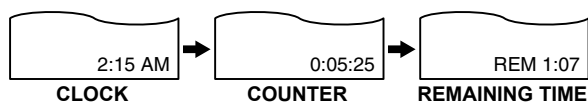

- Counter changes to "0:00:00" when the cassette is ejected.
- The real-time counter does not operate if nothing is recorded on the tape.
- The real-time counter will not work unless a tape is inserted.

Counter Memory Feature

This is useful if there is a section of tape you want to view immediately after recording or if you want to return to the same point several times.

1. Begin recording or playing a tape.
 2. Press **CLK/CNT** repeatedly to display the real-time counter on the TV screen.
 3. At the point that you want to locate later, reset the real-time counter to "0:00:00" by pressing **CLEAR**.
 4. Continue to play or record.
 5. Press **STOP** (■) once or twice when recording or playback finishes.
 6. Press **BACKWARD** (◀◀).
- The tape automatically stops when the tape counter returns to about "0:00:00".

Tape Remaining

This function shows the remaining time on the tape during recording or playback.

Press **CLK/CNT** repeatedly until the **REM** indicator appears on the TV screen during recording or playback.

Note:

The remaining tape length indicator may not be displayed correctly depending on the condition of the tape and the kind of the tape (T-140, T-160, or T-210 etc.)

Additional Information

- In manual recording, Timer recording, Instant Timer Recording, playback, or fast forward modes, the Combi Receiver automatically starts rewinding the tape at the end of the tape. The cassette will stop at the beginning of the tape and be ejected, and the Home Theater System will turn itself off.
- After you have finished using the Home Theater System, rewind, eject, and remove the cassette. Place the cassette in its protective sleeve to protect it from dust. It is not necessary to rewind the cassette before removing it, but if you do, it will be ready to play or record the next time you use it.
- Be sure the Home Theater System Channel Selector is on the correct channel you wish to record. The channel that is being recorded can always be checked by tuning the television to the Home Theater System channel (3 or 4) and using the **TV/VCR** selector to turn the Combi Receiver's TV indicator off.
- Do not attempt to hook up more than one television set to the Home Theater System for either recording or playback.

Auto Play System

This Home Theater System features automatic playback.

Load a cassette (with the safety tab removed).

- The Output Source is changed to VCR mode automatically.
- The power turns on automatically and playback begins.
- At the end of the tape, the Home Theater System stops and rewinds the tape.
- The cassette is ejected after rewinding and the VCR turns itself off automatically.



Note:

Auto power off does not function during regular DVD play mode. (Home Theater System power stays on.)

DVD Operation

Playing a DVD

PLAYBACK SETUP

Turn on the TV and select the video input source connected to the Home Theater System.

TO INSERT DISCS

1. Press OPEN SEL./CLOSE on the unit.
"OPEN SEL" will appear in the display window.
2. Press the desired DISC (1-5) on the unit.
The selected disc tray number will appear in the display window and on the TV screen.
The drawer comes out and selected disc tray slides out.

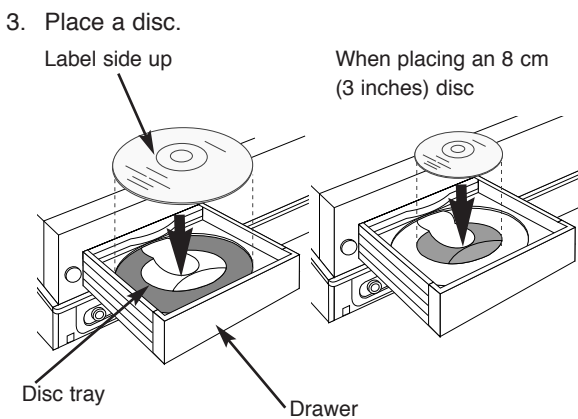

4. Press OPEN SEL./CLOSE to close the tray.
Playback starts automatically. If playback does not start, press PLAY(▶).
In some cases, the disc menu might appear instead:

DVD-V

Use the ◀ ▶ ▲ ▼ buttons to select the title/chapter you want to view, then press ENTER to start. Press TITLE or MENU to return to the menu screen.

DVD-A

Use the ◀ ▶ ▲ ▼ buttons to select an option you want, then press ENTER to view the option.

Notes:

- If parental control is set and the disc is not within the rating settings you must input the password. (See "Lock Menu" on page 27).
- DVDs may have a region code. Your Home Theater System does not play discs that have a region code different from your receiver. The region code for this receiver is 1 (one).

TO OPEN ALL DISCS

Press EJECT ALL on the unit to open all disc tray in the drawer during playback or stop.

"EJECT ALL" will appear in the display window.

You can check a disc in the disc tray.

TO SELECT A PLAYBACK DISC

Press DISC SEL. and press desired disc button (DISC 1-5) on the remote control.

Tip:

You can also use the disc number play buttons on the unit.

Notes:

- To ensure good system performance, wait until the disc tray completely read the disc(s) before proceeding.
- The Home Theater System is only able to read the status of the current selected disc tray.

TO REPLACE DISCS DURING PLAYBACK

You are able to replace or load a disc into the other four trays without interrupting current playback.

While playback, press OPEN SEL./CLOSE and press the desired DISC (1-5) on the unit to open disc tray (refer to "TO INSERT DISCS").

Notes:

- If you press OPEN SEL./CLOSE of the active disc tray, the disc will stop playing and the disc tray will slide out.
- Once the disc tray is opened, it will be deselected.
- Do not place more than one compact disc on one disc tray at the same time.
- Do not push the drawer to close the one, as you may damage the unit.

TO PLAY ALL DISCS ON THE DISC TRAYS **CD**

Press PLAY(▶) on the remote control or on the unit.

All the available discs will play once, then stop.

Tip:

During playback, track number and elapsed playing time of the current track will appear in the display window.

Note:

- This function is not available during Repeat playback or Programmed playback mode.

General Features

Note:

- Unless stated otherwise, all operations described use the remote control. Some features may also be available on the Setup menu.

MOVING TO ANOTHER TITLE/GROUP

DVD-V DVD-A

When a disc has more than one title/group, you can move to another title/group. Press DISPLAY while playback is stopped then the appropriate number (0-9) or use ◀ / ▶ to move to another title/group. You can play any title by inputting its number while playback is stopped.

MOVING TO ANOTHER CHAPTER/TRACK

DVD-V DVD-A DivX

When a title on a disc has more than one chapter or a disc has more than one track, you can move to another chapter/track as follows:

- Press BACKWARD ◀◀ or FORWARD ▶▶ briefly during playback to select the next chapter/track or to return to the beginning of the current chapter/track.
- Press BACKWARD ◀◀ twice briefly to step back to the previous chapter/track.
- To go directly to any chapter during DVD playback, press DISPLAY and press ▲ / ▼ to select the chapter/track icon. Then, input the chapter/track number or use ◀ / ▶.

SEARCH DVD-V DVD-A DivX

1. Press and hold BACKWARD ◀◀ or FORWARD ▶▶ for about two seconds during playback.
2. Press and hold BACKWARD ◀◀ or FORWARD ▶▶ repeatedly to select the required speed.
DVD, DivX disc; X2, X4, X16 or X100
3. To exit SEARCH mode, press PLAY ▶.

Note:

- When using a DVD audio disc that includes pictures, this operation may be permitted in some picture segments.

STILL PICTURE AND FRAME-BY-FRAME PLAYBACK DVD-V DVD-A DivX

1. Press PAUSE/STEP(II) on the remote control during playback. Advance the picture frame-by-frame by pressing PAUSE/STEP(II) repeatedly.
2. To exit still motion mode, press PLAY▶.

Note:

When using a DVD audio disc that includes pictures, this operation may be permitted in some picture segments.

SLOW SCAN DVD-V DVD-A DivX

1. Press PAUSE/STEP(II) during playback.
The Home Theater System will now go into PAUSE mode.
2. Use the BACKWARD ◀◀ or FORWARD ▶▶ to select the required speed: ◀◀ 1/16, ◀◀ 1/8, ◀◀ 1/4, or ◀◀ 1/2 (backward), or ▶▶ 1/16, ▶▶ 1/8, ▶▶ 1/4, or ▶▶ 1/2 (forward).

With a DivX Disc, the Slow speed changes: ▶▶ 1/16, ▶▶ 1/8, ▶▶ 1/4 or ▶▶ 1/2 (forward).

3. To exit Slow Motion mode, press PLAY ▶.

Notes:

- Slow motion playback in reverse is not possible with DivX Discs.
- When using a DVD audio disc that includes pictures, this operation may be permitted in some picture segments.

REPEAT A-B DVD-V DVD-A DivX

To repeat a sequence.

1. Press A-B at your chosen starting point. "A * " appears briefly on the TV screen.
2. Press A-B again at your chosen end point.
"A B" appears briefly on the TV screen and the repeat sequence begins.
3. Press A-B again to cancel.

REPEAT DVD-V DVD-A DivX

You can play a title/chapter/all/track/group on a disc. Press REPEAT during playback to select a desired repeat mode.

DVD Video Discs - Repeat Chapter/Title/Off

- Chapter: repeats the current chapter.
- Title: repeats the current title.
- Off : does not play repeatedly.

DivX discs - Repeat Track/All/Off

- Track : repeats the current track
- All : repeats all the tracks on a disc.
- Off : does not play repeatedly.

DVD Audio Discs - Repeat Track/Group/Off

- Track: repeats the current track.
- Group: repeats the current Group.
- Off : does not play repeatedly.

Note:

- If you press FORWARD ►► once during Repeat Chapter (Track) playback, the repeat playback cancels.

3D SURROUND DVD-V DivX

To produce a 3D surround effect that simulates multi-channel audio from two stereo speakers (instead of the five+ speakers normally required for multi-channel audio from a home theater system).

1. Press DISPLAY during playback.
2. Use ▲ or ▼ to select the sound option. The sound option will be highlighted.
3. Use ◀ or ▶ to select "3D SURR.". To turn off the 3D Surround effect, select "BYPASS".

TIME SEARCH DVD-V DivX

To start playing at any chosen time on the disc:

1. Press DISPLAY during playback. The time search box shows the elapsed playing time.
2. Press ▲ / ▼ to select the time clock icon and "--:--" appears.
3. Input the required start time in hours, minutes, and seconds from left to right. If you enter the wrong numbers, press CLEAR to remove the numbers you entered. Then input the correct numbers.
4. Press MEMORY/ENTER to confirm. Playback starts from the selected time.

ZOOM DVD-V DVD-A DivX

Use zoom to enlarge the video image.

1. Press ZOOM during playback or still playback to activate the Zoom function. The square frame appears briefly in the right bottom of the picture.
2. Each press of the ZOOM button changes the TV screen in the sequence: 100% size → 400% size → 1600% size → screen fit mode → 100% size
Screen fit mode:
You can change the way the image appears on the screen when you're playing a DVD movie. Press ▲/▼ to select between Normal, Enhanced, and Maximum.
3. Use the ◀ ▶ ▲ ▼ buttons to move through the zoomed picture.
4. To resume normal playback, press CLEAR.

Notes:

- Zoom may not work on some DVDs.
- Screen fit mode is available for playing the DVD disc, VR disc and movie file.

MARKER SEARCH DVD-V DivX**To enter a Marker**

You can start playback from up to nine memorized points. To enter a marker, press MARKER at the desired point on the disc. The Marker icon appears on the TV screen briefly. Repeat to enter up to nine markers.

To Recall or Clear a Marked Scene

1. During disc playback, press SEARCH. The marker search menu appears on the screen.
2. Within 10 seconds, press ◀ / ▶ to select a marker number that you want to recall or clear.
3. Press MEMORY/ENTER and playback starts from the marked scene. Or, Press CLEAR and the marker number is erased from the list.
4. You can play any marker by inputting its number on the marker search menu.

PAUSE DVD-V DVD-A DivX

1. Press PAUSE/STEP(II) during playback.
2. To return to playback, press PLAY(▶).

Special DVD Features

CHECKING THE CONTENTS OF DVD DISCS: MENUS

DVDs may offer menus that allow you to access special features. To use the disc menu, press DVD MENU. Input the corresponding number or use the ◀ ▶ ▲ ▼ buttons to highlight your selection. Then press MEMORY/ENTER.

TITLE MENU DVD-V DVD-A

1. Press TITLE. If the current title has a menu, the menu appears on the screen. Otherwise, the disc menu may appear.
2. The menu offers features such as camera angles, spoken language and subtitle options, and chapters for the title.
3. Press TITLE to exit.

DISC MENU DVD-V DVD-A

Press DISC MENU and the disc menu is displayed. Press DISC MENU again to exit.

CAMERA ANGLE DVD-V DVD-A

If the disc contains scenes recorded at different camera angles, you can change to a different camera angle during playback. Press ANGLE repeatedly during playback to select a desired angle. Note that the number of the current angle appears on the display.

Tip:

The angle indicator will blink on the TV screen during scenes recorded at different angles as an indication that angle switching is possible.

CHANGING THE AUDIO LANGUAGE

DVD-V DVD-A DivX

Press AUDIO repeatedly during playback to hear a different audio language or audio track.

With DVD-RW discs recorded in VR mode that have both a main and a Bilingual audio channel, you can switch between Main (L), Bilingual (R), or a mix of both (Main + Bilingual) by pressing AUDIO.

SUBTITLES DVD-V DivX

Press SUBTITLE repeatedly during playback to see the different subtitle languages.

Note:

- The subtitle file of the DivX file is displayed only smi, srt and sub.
- If there is no information or there is a code that can not read in the DivX file, " 1 " etc are displayed.

DVD Audio Discs

DVD Audio is a new disc format building on the success of DVD to provide high quality, uncompressed, multi-channel audio for a new experience in audio quality. A DVD Audio disc can be identified by the DVD audio logo on the disc jacket or on the disc itself.

DVD Audio can provide higher quality stereo than Audio CDs with a sampling rate of up to 192kHz (compared to 44.1kHz for CDs). DVD Audio digital sound can be delivered with up to 24 bits of data (compared to 16 bits for a standard CD).

A typical DVD Audio disc contains up to seven times the data capacity of a CD. This additional space is used for music, either Advanced Resolution multi-channel sound quality that is closer to the artist's master recording or for longer recordings. Many DVD Audio discs contain on-screen text, such as artist biographies, playlists, or lyrics. Some DVD Audio discs contain photo galleries or video clips.

Note:

To enjoy maximum sound quality and surround effect of DVD Audio, you must use 5.1 channel analog audio output (5.1CH AUDIO OUT jacks on the Combi Receiver). If you use the DIGITAL OUT (OPTICAL or COAXIAL) for your audio connection, the sound will only be similar to CD-quality sound even though you're playing a DVD Audio disc.

Moving to another GROUP

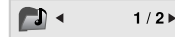

Some DVD Audio discs divide content into different groups. Your player enables you to quickly access different groups during playback via the on-screen display.

1. Press DISPLAY during playback on in stop mode.
2. Press ▲▼ to select Group icon.
3. Press ◀▶ or the numbered buttons (0-9) to select a group number.

Note:

Sometimes the author of the disc creates hidden content that can only be accessed by entering a password. If the lock icon appears on the TV screen, enter the password (sometimes you'll find it on the disc's jacket cover or on a web site). This password control isn't dictated by your Combi Receiver — it is a function of the disc.

Since the authoring of DVD Audio Discs varies, some of the on-screen display choices might not be available for the disc you're playing.

Viewing another PAGE

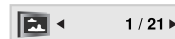

Since DVD Audio discs can hold a lot of content, there are various ways to see what's available on the disc.

1. Press DISPLAY during playback.
2. Press ▲▼ to select Page icon.
3. Press ◀▶ to select a page number.

What appears on the screen will vary from disc to disc because the information available depends upon the way the disc was created.

Note:

Since the authoring of DVD Audio Discs varies, some of the on-screen display choices might not be available for the disc you're playing.

Playing an Audio CD or MP3/WMA Disc

The Home Theater System can play MP3/WMA formatted recordings on CD-ROM, CD-R, or CD-RW discs.

Audio CD

Once you insert an audio CD a menu appears on the TV screen. Press ▲ / ▼ to select a track then press PLAY (▶) or MEMORY/ENTER and playback starts.

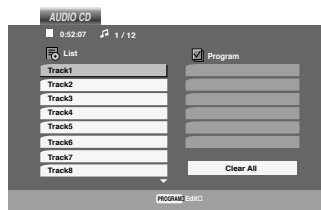

MP3/WMA

1. Press ▲ / ▼ to select a folder, and press ENTER to see the folder contents.
2. Press ▲ / ▼ to select a track then press PLAY (▶) or MEMORY/ENTER and playback starts.

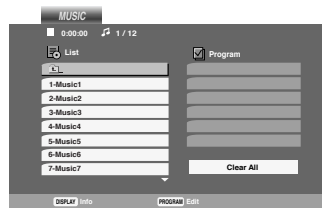

ID3 TAG

- When playing a file containing information such as track titles, you can see the information by pressing DISPLAY. [Title, Artist, Album, Year, Comment]
- If there is no information, "NO ID3 TAG" appear on the display.

Tip:

- If you are in a file list on the MUSIC menu and want to return to the Folder list, use the ▲ / ▼ to highlight  and press MEMORY/ENTER.
- Press MENU to move to the next page.
- On a CD with MP3/WMA and JPEG you can switch MP3/WMA and JPEG. Press TITLE and MUSIC or PHOTO word on top of the menu is highlighted.

MP3 / WMA disc compatibility with this receiver is limited as follows:

- Sampling frequency: within 8 - 48 kHz (MP3), within 32 - 48kHz (WMA)
- Bit rate: within 8 - 320kbps (MP3), 32 - 192kbps (WMA)
- The player cannot read an MP3/WMA file that has a file extension other than ".mp3" / ".wma".
- CD-R physical format should be ISO 9660
- If you record MP3 / WMA files using software that cannot create a file system (eg. Direct-CD) it is impossible to playback MP3 / WMA files. We recommend that you use Easy-CD Creator, which creates an ISO 9660 file system.
- File names should have a maximum of 8 letters and must incorporate an .mp3 or .wma extension.
- They should not contain special letters such as / ? * : " < > | etc.
- The total number of files on the disc should be less than 650.

This Home Theater System requires discs and recordings to meet certain technical standards in order to achieve optimal playback quality. Pre-recorded DVDs are automatically set to these standards. There are many different types of recordable disc formats (including CD-R containing MP3 or WMA files) and these require certain pre-existing conditions (see above) to ensure compatible playback.

Customers should note that permission is required in order to download MP3 / WMA files and music from the Internet. Our company has no right to grant such permission. Permission should always be sought from the copyright owner.

Audio CD and MP3 / WMA Disc Features

PAUSE **CD** **MP3** **WMA**

1. Press PAUSE/STEP(II) during playback.
2. To return to playback, press PLAY (▶) , MEMORY/ENTER or press PAUSE/STEP(II) again.

MOVING TO ANOTHER TRACK **CD**

MP3 **WMA**

1. Press PLAY (▶) briefly during playback to go to the next track or to return to the beginning of the current track.
2. Press BACKWARD I◀◀ twice briefly to go back to the previous track.
3. You can play any track by inputting its number.

REPEAT TRACK/ALL/OFF **CD** **MP3**

WMA

You can play a track/all on a disc.

1. Press REPEAT when playing a disc. The repeat icon appears.
2. Press REPEAT to select a desired repeat mode.
 - Track: repeats the current track
 - All: repeats all the tracks on a disc.
 - Off(No display): does not play repeatedly.

Note:

If you press FORWARD ▶▶I once during Repeat Track playback, the repeat playback cancels.

SEARCH **CD** **MP3** **WMA**

1. Press and hold BACKWARD I◀◀ or FORWARD ▶▶I for about two seconds during playback.
2. Press and hold BACKWARD I◀◀ or FORWARD ▶▶I repeatedly to select the required speed: X2, X4, X8 backward or forward.
3. To exit SEARCH mode, press PLAY (▶).

REPEAT A-B **CD**

1. To repeat a sequence during disc playback press A-B at your chosen starting point. The Repeat icon and "A" appear on the menu screen.
2. Press A-B again at your chosen end point. The Repeat icon and "A-B" appear on the menu screen, and the sequence begins to play repeatedly.
3. To exit the sequence and return to normal play, press A-B again. The Repeat icon disappears from the menu screen.

3D SURROUND **CD**

To produce a 3D surround effect that simulates multi-channel audio from two stereo speakers (instead of the five+ speakers normally required for multi-channel audio from a home theater system).

1. Press AUDIO during playback. "3D SURR." appears on the menu screen.
2. To return to normal playback, press AUDIO repeatedly until "3D SURR." disappears from the menu screen.

Programmed Playback

The program function enables you to store your favorite tracks from any disc in the receiver memory. A program can contain 30 tracks.

1. Insert a disc.
Audio CD or MP3/WMA Discs:
AUDIO CD or MUSIC menu appears.

2. Press PROGRAM.
The  mark will appear to the right of the word "Program" on the right side of the menu screen.

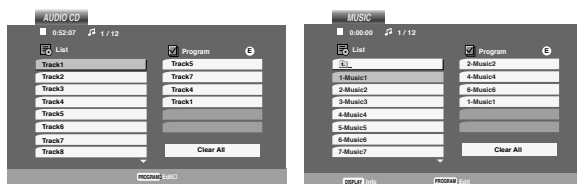

Note:

Press PROGRAM again, then the  mark will disappear to exit the Program Edit mode.



Audio CD Menu

MP3/WMA Menu

3. Select a track on the "List", then press ENTER to place the selected track on the "Program" list. Repeat to place additional tracks on the list.
4. Press .
Select the track you want to start playing on the "Program" list.
5. Press PLAY () or MEMORY/ENTER to start. Playback begins in the order in which you programmed the tracks. Playback stops after all of the tracks on the "Program" list have played once.
6. To resume normal playback from programmed playback, select a track of AUDIO CD (or MUSIC) list and then press PLAY ().



REPEAT PROGRAMMED TRACKS

1. Press REPEAT when playing a disc. The repeat icon appears.
2. Press REPEAT to select a desired repeat mode.
 - Track: repeats the current track
 - All: repeats all the tracks on programmed list.
 - Off(No display): does not play repeatedly.



Note:

If you press FORWARD () once during Repeat Track playback, the repeat playback cancels.

ERASING A TRACK FROM "PROGRAM" LIST

1. Use    to select the track that you wish to erase from the Program list.
2. Press CLEAR. Repeat to erase additional tracks on the list.

ERASING THE COMPLETE PROGRAM LIST

1. Press  to move to the "Program" list.
2. Use  /  to select "Clear All", then press MEMORY/ENTER.

Note:

The programs are also cleared when the disc is removed.

Viewing a JPEG Disc

Using this Home Theater System you can view discs with JPEG files.

1. Insert a disc and close the tray. The PHOTO menu appears on the TV screen.

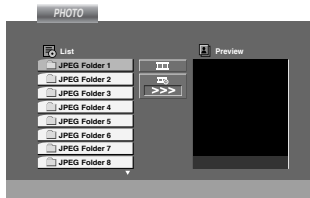

2. Press ▲ / ▼ to select a folder, and press MEMORY/ENTER. A list of files in the folder appears. If you are in a file list and want to return to the previous Folder list, use the ▲ / ▼ buttons on the remote to highlight [Left Arrow] and press MEMORY/ENTER.
3. If you want to view a particular file, press ▲ / ▼ to highlight a file and press MEMORY/ENTER or PLAY (▶). Viewing the file proceeding starts. While viewing a file, you can press STOP to move to the previous menu (PHOTO menu).

Tips:

- Press MENU to move to the next page.
- There are three Slide Speed options [Fast] : >>> (Fast), >> (Normal), and > (Slow). Use ▲ ▼ ◀ ▶ to highlight the Speed. Then, use ◀ / ▶ to select the option you want to use then press MEMORY/ENTER.
- On a disc with MP3/WMA and JPEG you can switch MP3/WMA and JPEG. Press TITLE and MUSIC or PHOTO word on top of the menu is highlighted.
- Press RETURN, information of file is hidden.

SLIDE SHOW [JPEG]

Use ▲ ▼ ◀ ▶ to highlight the [Slide Show] then press MEMORY/ENTER.

STILL PICTURE [JPEG]

1. Press PAUSE/STEP(⏏) during slide show. The player will now go into PAUSE mode.
2. To return to the slide show, press PLAY (▶) or press PAUSE/STEP(⏏) again.

MOVING TO ANOTHER FILE [JPEG]

Press BACKWARD ◀◀ or FORWARD ▶▶ or cursor (◀ or ▶) once while viewing a picture to advance to the next or previous file.

ZOOM [JPEG]

Use zoom to enlarge the photo image. (see page 37)

TO ROTATE PICTURE [JPEG]

Press ▲ / ▼ during showing a picture to rotate the picture clockwise or counter clockwise.

TO LISTEN TO MP3/WMA MUSIC

WATCHING PICTURE [JPEG]

You can display files while listening to MP3/WMA music files recorded on the same disc.

1. Insert the disc containing the two types of file in the player.
2. Press TITLE to display PHOTO menu.
3. Press ▲ / ▼ to select a photo file.
4. Use ▶ to select [Picture] icon then press MEMORY/ENTER. Playback starts. The playback will continue until STOP is pressed.

Tip:

To listen to only the desired music watching picture, programmed the desired tracks from the "MUSIC" menu and then proceed as above.

JPEG disc compatibility with this unit is limited as follows:

- Depending upon the size and number of JPEG files, it could take a long time for the Home Theater System to read the disc's contents. If you don't see an on-screen display after several minutes, some of the files may be too large — reduce the resolution of the JPEG files to less than 2M pixels as 2760 x 2048 pixels and burn another disc.
- The total number of files and folders on the disc should be less than 650.
- Some discs may be incompatible due to a different recording format or the condition of disc.
- Ensure that all the selected files have the ".jpg" extensions when copying into the CD layout.
- If the files have ".jpe" or ".jpeg" extensions, please rename them as ".jpg" file.
- File names without ".jpg" extension will not be able to be read by this Home Theater System. Even though the files are shown as JPEG image files in Windows Explorer.

Playing a DVD VR format Disc

This unit will play DVD-R/RW discs recorded using the DVD-Video format that have been finalized using a DVD-recorder.

- This unit will play DVD-RW discs recorded using the Video Recording (VR) format.

1. Insert a disc and close the tray. The DVD-VR menu appears on the TV screen.

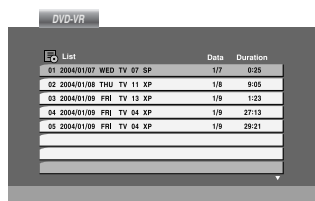

2. Press ▲ / ▼ to select a track then press PLAY (▶) or MEMORY/ENTER and playback starts.

Notes:

- Unfinalized DVD-R/RW discs cannot be played in this player.
- Some DVD-VR disc are made with CPRM data by DVD RECORDER. Player does not support these kinds of discs and display the "CHECK DISC".

What is 'CPRM'?

CPRM is a copy protection system (with scramble system) only allowing the recording of 'copy once' broadcast programs. CPRM stands for Content Protection for Recordable Media.

This player is CPRM compatible, which means that you can record copy-once broadcast programs, but you cannot then make a copy of those recordings. CPRM recordings can only be made on DVD-RW discs formatted in VR mode, and CPRM recordings can only be played on players that are specifically compatible with CPRM.

Maintenance and Service

Refer to the information in this chapter before contacting a service technician.

HANDLING THE UNIT

When shipping the unit

Please save the original shipping carton and packing materials. If you need to ship the unit, for maximum protection, re-pack the unit as it was originally packed at the factory.

Keeping the exterior surfaces clean

- Do not use volatile liquids such as insecticide spray near the unit.
- Do not leave rubber or plastic products in contact with the unit for a long period of time. since they leave marks on the surface.

Cleaning the unit

To clean the receiver, use a soft, dry cloth. If the surfaces are extremely dirty, use a soft cloth lightly moistened with a mild detergent solution.

Do not use strong solvents such as alcohol, benzene, or thinner, as these might damage the surface of the unit.

Maintaining the Unit

The Combi Receiver is a high-tech, precision device. If the optical pick-up lens and disc drive parts are dirty or worn, the picture quality could be diminished.

Depending on the operating environment, regular inspection and maintenance are recommended after every 1,000 hours of use.

For details, please contact your nearest authorized service center.

Playing a DivX Movie Disc

Using this Home Theater System you can play DivX disc.

1. Insert a disc and close the tray. The MOVIE menu appears on the TV screen.

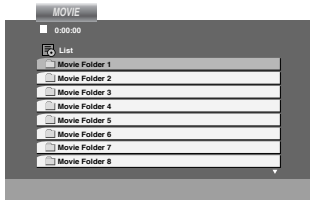

2. Press ▲ / ▼ to select a folder, and press MEMORY/ENTER. A list of files in the folder appears. If you are in a file list and want to return to the Folder list, use the ▲ / ▼ buttons on the remote to highlight and press MEMORY/ENTER.
3. If you want to view a particular file, press ▲ / ▼ to highlight a file and press MEMORY/ENTER or PLAY (▶).
4. Press STOP to exit.

Tips:

- Press DISC MENU to move to the next page.
- On a CD with MP3/WMA, JPEG and MOVIE file, you can switch MUSIC, PHOTO and MOVIE menu. Press TITLE and MUSIC, PHOTO and MOVIE word on top of the menu is highlighted.

DivX disc compatibility with this player is limited as follows:

- Available resolution size of the DivX file is under 720x576 (W x H) pixel.
- The file name of the DivX subtitle is available by 56 characters.
- If there is impossible code to express in the DivX file, it may be displayed as " _ " mark on the display.
- **If the number of the screen frame is over 30 per 1 second, this unit may not operate normally.**
- **If the video and audio structure of recorded file is not interleaved, either video or audio is outputted.**
- **If the file is recorded with GMC, the unit supports only 1-point of the record level.**
 - * GMC?

GMC is the acronym for Global Motion Compensation. It is an encoding tool specified in MPEG4 standard. Some MPEG4 encoders, like DivX or Xvid, have this option. There are different levels of GMC encoding, usually called 1-point, 2-point, or 3-point GMC.

Playable DivX file

- ".avi ", ".mpg ", ".mpeg "

Playable Codec format

- "DIVX3.xx ", "DIVX4.xx ", "DIVX5.xx ", "XVID ", "MP43 ", "3IVX "

Playable Audio format

- "AC3 ", "DTS ", "PCM ", "MP3 ", "WMA "
 - Sampling frequency: within 8 - 48 kHz (MP3), within 32 - 48kHz (WMA)
 - Bit rate: within 8 - 320kbps (MP3), 32 - 192kbps (WMA)

5.1 Speaker Setup

This chapter includes important reference information to help you set your Home Theater System.

Speaker Setup

Make the following settings for the built-in 5.1 channel surround decoder.

1. Press SETUP. The setup menu appears.
2. Use ▲ / ▼ to select the AUDIO option then press ► to move to the second level.
3. Use ▲ / ▼ to select the Speaker Setup option then press ► to move to the third level. "Select" is highlighted.
4. Press MEMORY/ENTER and 5.1 Speaker Setup menu appears.

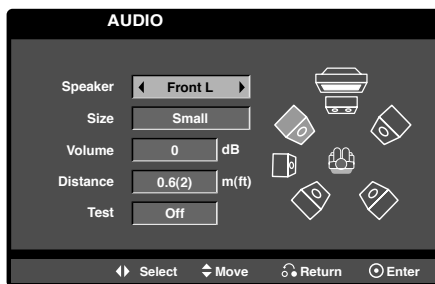

5. Use ◀ / ▶ to select the desired speaker.
6. Adjust options using ▲ / ▼ / ◀ / ▶ buttons.
7. Press ENTER to confirm your selection. Returns to the previous menu.

Speaker selection

Select a speaker that you want to adjust. (Front speakers (Left), Center Speaker, Front speakers (Right), Rear speakers (Right), Rear speakers (Left), or SubWoofer)

Note:

Certain speaker settings are prohibited by the Dolby Digital licensing agreement.

Size

Since the speaker settings are fixed, you cannot change the settings.

Volume

Press ◀ / ▶ to adjust the output level of the selected speaker. (-6dB ~ +6dB)

Distance

If you connected speakers to your Home Theater System, setting the Distance lets the speakers know how far the sound has to travel to reach your set listening point. This allows the sound from each speaker to reach the listener at the same time.

Press ◀ / ▶ to adjust the Distance of the selected speaker.

[0.3(1)m(ft) - 6.0(20)m(ft)]

Test

Press ◀ / ▶ to test the signals of each speaker. Adjust the volume to match the volume of test signals memorized in the system.

Front Left (L) → Center → Front Right (R) →
Rear Right (R) → Rear Left (L) → SubWoofer

You can adjust the volume during operating the test tone, first use ▲ / ▼ to select Volume or Speaker option then use ◀ / ▶ buttons to select volume or speaker, so that all speaker's volume is same from the listener's position.

During operating the test tone, if you adjust the volume, it will be paused in the current speaker channel.

Additional Features

SCREEN SAVER

The screen saver appears when you leave the Home Theater System in Stop mode for about five minutes. If the Screen Saver is displayed for five minutes, the Home Theater System automatically turns itself off.

VIDEO MODE SETTING

The video mode setting only works when the Progressive Scan mode is set to "On" in the Setup menu.

- With certain discs, the playback picture may be flickering or Dot Crawl is shown on straight lines. That means Vertical interpolation or De-interlace is not perfectly matched with the disc. In this case, the picture quality may be improved by changing the video mode.
- To change the video mode, press and hold DISPLAY about 3 seconds during disc playback. The new video mode number selected is displayed on the TV screen. Check whether the video quality has improved. If not, repeat the above procedure until picture quality is improved.
- Video mode change sequence:
MODE1 → MODE2 → MODE3 → MODE1
- If you turn off the power, the video mode will be back to initial state (MODE1).

Tip:

Detailed Descriptions for Video Modes

MODE1: The source material of the DVD video (film material or video material) is determined from disc information.

MODE2: Suitable for playing film based content or video based material recorded by the progressive scan method.

MODE3: Suitable for playing video based content with comparatively little motion.

XTS (EXCELLENT TRUE SOUND)

You can enjoy the vivid stereophonic sound of the digital original source without any signal distortion.

Each time you press XTS during 2 channel mode, the setting changes in the following order.

XTS- 1 → XTS- 2 → XTS- 3 → XTS OFF ...

Tips:

- XTS- 1: When playing the movie with the weak bass sound relatively to the general music, it enforces the sense of sound at woofer for you to satisfy with.
- XTS- 2: In the mode of 2 CH BYPASS, It creates the high display effect by playing the sound source via the rear speakers same as the front speakers.
- XTS- 3: You can operate both XTS- 1 and XTS- 2 simultaneously and it can complement the relative degrading of the sound pitch of the woofer at the XTS- 2 mode.

Note:

The XTS- 2 mode is temporarily disabled when changing from 2.1 CH to 5.1 CH and it is enabled when changing it to 2.1 CH.

RADIO Operation

Presetting the Radio Stations

You can preset 50 stations for FM and AM. Before tuning, make sure that you have turned down the volume.

1. Press FM/AM on the remote control until the frequency band appears on the display and TV screen.

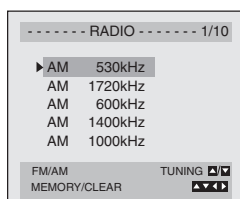

2. Use ▲/▼ on the remote control to select the desired Station.
If you select a blank column, R-SKIP appears in the display window.

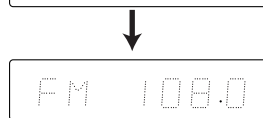
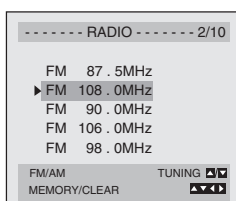

3. Press FM/AM on the remote control to select the desired band.
4. Hold down TUNING (▼/▲) on the remote control for 1 or 2 seconds, and a station is searched for automatically.
5. Press MEMORY/ENTER on the remote control. The station is stored.



6. Repeat steps 2 to 5 to store other stations.

Listening to the Radio

Preset radio stations in the Combi Receiver memory first (see "Presetting Radio Stations" on the left).

1. Press FM/AM on the remote control until the frequency band appears on the display and TV screen.

The last received station is tuned in.

2. Use ▲/▼ on the remote control repeatedly to select the preset station you want.
Each time you press the button, the DVD/VCR Receiver tunes in one preset station at a time.
3. Adjust the volume by rotating VOLUME on the front panel or by pressing VOLUME + or - on the remote control repeatedly.

To Clear the Stored Radio Stations

1. Press FM/AM on the remote control until the frequency band appears on the display and TV screen.

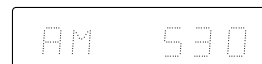
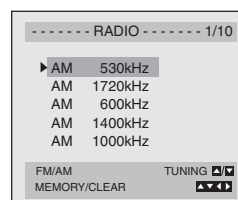

2. Use ▲/▼ on the remote control to select your desired station.

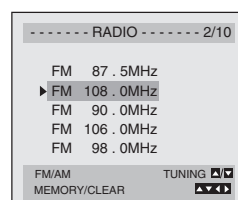

3. Press CLEAR the remote control to clear the stored radio station.

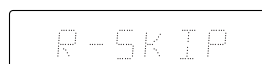
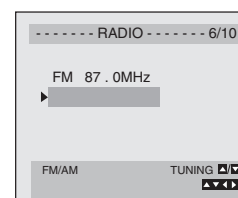

Note:

While record or record pause mode, the CLEAR function may not be operated.

Tuning Stations Manually

1. Press FM/AM on the remote control until the frequency band appears on the display and TV screen.
2. Use FM/AM on the remote control to select the desired band.
3. Use ▼ TUNING ▲ on the front panel or press ◀ and ▶ on the remote control to tune in the desired station.

FOR YOUR REFERENCE

To turn the radio off

Press POWER to turn the Combi Receiver off or select another function mode (DVD, VCR, L 1 or L 2).

Tuning Stations Automatically

Hold down ▼ TUNING ▲ on the front panel for 1 or 2 seconds, and the next station is searched for automatically.

Note:

The search may not tune in or stop at a station with a very weak signal.

Mute

1. Press MUTE to remove the sound.
You can mute your unit in order, for example, to answer the telephone, "MUTE" indicator appears in the display.
2. Press MUTE again to restore sound.

Labeling Stations

You can enter a name of up to 5 characters for preset stations. The names (for example, "ABCD") appears in the system's Display window when a station is selected.

Note that no more than one name can be entered for each preset station.

1. Press ▶ to move to the station name column.

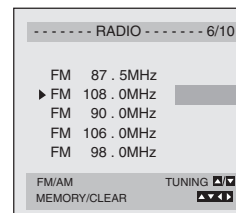

2. Use the ▲/▼ buttons to select the character then use the ◀/▶ buttons to shift to the next or previous character.
3. Press MEMORY/ENTER to confirm the station name.
4. Press MEMORY/ENTER on the remote control. The station name is stored.

Controlling your TV with the Supplied Remote

You can control the sound level, input source, and power switch of your LG TV with the supplied remote.

You can control your TV using the buttons below.

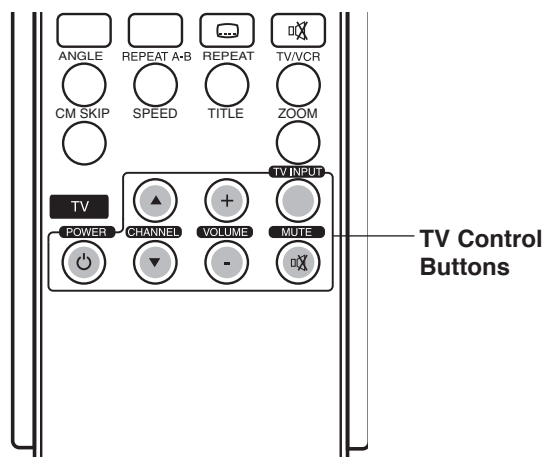

By pressing	You can
TV POWER	Turn the TV on or off.
CHANNEL(▲ / ▼)	Scans up or down through memorized channels.
VOLUME +/-	Adjust the volume of the TV.
TV INPUT	Switch the TV's input source between the TV and other input sources.
MUTE	Turns on or off TV sound.

Note:

Depending on the unit being connected, you may not be able to control your TV using some of the buttons.

Controlling other TVs with the Supplied Remote

You can control the sound level, input source, and power switch of non-LG TVs as well. If your TV is listed in the table below, set the appropriate manufacturer code.

1. While holding down TV POWER button, press the number buttons to select the manufacturer code for your TV (Refer to table on the right column).
2. Release TV POWER button.

Code Numbers of Controllable TVs

If more than one code number is listed, try entering them one at a time until you find the one that works with your TV.

Manufacturer	Code Number	Manufacturer	Code Number
ADMIRAL	16,33,37,44,45	MONTGOMERY	01,06,08,09
AIWA	70	WARD	23,24,32,33,34
AKAI	01	NEC	01,08
AMARK	09	NOBLEX	07
AOC	01	PACKARD BELL	43
BELL & HOWELL	33	PANASONIC	07,11,13,25,35,36
BROKSONIC	18,19	PHILCO	01,06,07,08,09,
CANDLE	51		15,38,43,58
CCE	07	PHILIPS	06,07,43,61,62,65
CENTURION	08	PIONEER	30
CINERAL	43	PORTLAND	09
CITIZEN	49,50,51,52,53,54,55	PROSCAN	03,37,44
CORONADO	09	QUASAR	11,13
CROWN	09	RADIO SHACK	16,17,23
CURTIS MATHES	01,03,08,33,35,37,44	RCA	01,03,37,44,69
DAEWOO	16,38,39,40,41,42,43	REALISTIC	16,17,23
DAYTRON	01,08	SAMPO	08
EMERSON	01,09,16,17,18,19	SAMSUNG	01,08,09,25,68
FISHER	28,29	SANYO	28,29
FUNAI	46,47	SCOTT	01,08
GENERAL ELECTRIC	03,10,11,13,37,44	SEARS	09,25,26,27,28,29
GRADIENTE	01,56,57,63,67	SEMP	64
HITACHI	09,14,15,43	SHARP	09,22,23,24,60,66
JC PENNEY	01,08,10,27,35	SIGNATURE 2000	01,06,08,09,10,
JVC	20,21,63,67		23,24,33,34
KIOTE	43	SONY	12,62
KMC	09	SOUNDESIGN	51
KTV	01,08,09,31	SYLVANIA	01,04,05,06,07,
LG (GOLDSTAR)	01,07,08,09,35,39,40		08,35,51
LODGENET	33	SYMPHONIC	46,47
LOGIK	33	TATUNG	11
LXI	09,24,25,26,27,28,29	TEKNIKA	07,09,16,33,51
MAGNAVOX	01,02,04,05,06,	TELERENT	09,33
	07,08,09,20,	THOMSON	69
	34,35,43,51,61,62,65	YORX	08
MAJESTIC	33	TOSHIBA	01,25,26,27,64
MARANTZ	01,32	WARDS	01,06,08,09,10,33,34
MEMOREX	33	XR1000	48
MGAMITSUBISHI	01,08,32,34	ZENITH	01,02,33,59

Notes:

- Depending on your TV, some or all buttons may not function on the TV, even after entering the correct manufacturer code.
- If you enter a new code number, the code number previously entered will be erased.
- When you replace the batteries of the remote, the code number you have set may be reset to the default setting. Set the appropriate code number again.

Language Codes

Use this list to input your desired language for the following initial settings:
Disc Audio, Disc Subtitle, Disc Menu.

Language	Code	Language	Code	Language	Code	Language	Code
Abkhazian	6566	Fiji	7074	Lingala	7678	Singhalese	8373
Afar	6565	Finnish	7073	Lithuanian	7684	Slovak	8375
Afrikaans	6570	French	7082	Macedonian	7775	Slovenian	8376
Albanian	8381	Frisian	7089	Malagasy	7771	Somali	8379
Ameharic	6577	Galician	7176	Malay	7783	Spanish	6983
Arabic	6582	Georgian	7565	Malayalam	7776	Sudanese	8385
Armenian	7289	German	6869	Maltese	7784	Swahili	8387
Assamese	6583	Greek	6976	Maori	7773	Swedish	8386
Aymara	6588	Greenlandic	7576	Marathi	7782	Tagalog	8476
Azerbaijani	6590	Guarani	7178	Moldavian	7779	Tajik	8471
Bashkir	6665	Gujarati	7185	Mongolian	7778	Tamil	8465
Basque	6985	Hausa	7265	Nauru	7865	Tatar	8484
Bengali; Bangla	6678	Hebrew	7387	Nepali	7869	Telugu	8469
Bhutani	6890	Hindi	7273	Norwegian	7879	Thai	8472
Bihari	6672	Hungarian	7285	Oriya	7982	Tibetan	6679
Breton	6682	Icelandic	7383	Panjabi	8065	Tigrinya	8473
Bulgarian	6671	Indonesian	7378	Pashto, Pushto	8083	Tonga	8479
Burmese	7789	Interlingua	7365	Persian	7065	Turkish	8482
Byelorussian	6669	Irish	7165	Polish	8076	Turkmen	8475
Cambodian	7577	Italian	7384	Portuguese	8084	Twì	8487
Catalan	6765	Japanese	7465	Quechua	8185	Ukrainian	8575
Chinese	9072	Javanese	7487	Rhaeto-Romance	8277	Urdu	8582
Corsican	6779	Kannada	7578	Rumanian	8279	Uzbek	8590
Croatian	7282	Kashmiri	7583	Russian	8285	Vietnamese	8673
Czech	6783	Kazakh	7575	Samoan	8377	Volapük	8679
Danish	6865	Kirghiz	7589	Sanskrit	8365	Welsh	6789
Dutch	7876	Korean	7579	Scots Gaelic	7168	Wolof	8779
English	6978	Kurdish	7585	Serbian	8382	Xhosa	8872
Esperanto	6979	Laothian	7679	Serbo-Croatian	8372	Yiddish	7473
Estonian	6984	Latin	7665	Shona	8378	Yoruba	8979
Faroese	7079	Latvian, Lettish	7686	Sindhi	8368	Zulu	9085

Country Codes

Choose a country code from this list.

Country	Code	Country	Code	Country	Code	Country	Code
Afghanistan	AF	Ethiopia	ET	Malaysia	MY	Saudi Arabia	SA
Argentina	AR	Fiji	FJ	Maldives	MV	Senegal	SN
Australia	AU	Finland	FI	Mexico	MX	Singapore	SG
Austria	AT	France	FR	Monaco	MC	Slovak Republic	SK
Belgium	BE	Germany	DE	Mongolia	MN	Slovenia	SI
Bhutan	BT	Great Britain	GB	Morocco	MA	South Africa	ZA
Bolivia	BO	Greece	GR	Nepal	NP	South Korea	KR
Brazil	BR	Greenland	GL	Netherlands	NL	Spain	ES
Cambodia	KH	Islands	HM	Netherlands Antilles	AN	Sri Lanka	LK
Canada	CA	Hong Kong	HK	New Zealand	NZ	Sweden	SE
Chile	CL	Hungary	HU	Nigeria	NG	Switzerland	CH
China	CN	India	IN	Norway	NO	Taiwan	TW
Colombia	CO	Indonesia	ID	Oman	OM	Thailand	TH
Congo	CG	Israel	IL	Pakistan	PK	Turkey	TR
Costa Rica	CR	Italy	IT	Panama	PA	Uganda	UG
Croatia	HR	Jamaica	JM	Paraguay	PY	Ukraine	UA
Czech Republic	CZ	Japan	JP	Philippines	PH	United States	US
Denmark	DK	Kenya	KE	Poland	PL	Uruguay	UY
Ecuador	EC	Kuwait	KW	Portugal	PT	Uzbekistan	UZ
Egypt	EG	Libya	LY	Romania	RO	Vietnam	VN
El Salvador	SV	Luxembourg	LU	Russian Federation	RU	Zimbabwe	ZW

Troubleshooting

Check the following guide for the possible cause of a problem before contacting service.

Symptom	Cause	Correction
No power.	<ul style="list-style-type: none"> The power cord is disconnected. 	<ul style="list-style-type: none"> Plug the power cord into the wall outlet securely.
The power is on, but the Home Theater System does not work.	<ul style="list-style-type: none"> No disc is inserted. No tape is inserted. 	<ul style="list-style-type: none"> Insert a disc or tape. (Check that the disc or tape indicator in the display window is lit.)
No picture.	<ul style="list-style-type: none"> The TV is not set to receive Combi Receiver signal output. 	<ul style="list-style-type: none"> Select the appropriate video input mode on the TV so the picture from the Home Theater System appears on the TV screen.
	<ul style="list-style-type: none"> TV/VCR mode for Home Theater System is set to TV. 	<ul style="list-style-type: none"> Press the TV/VCR button on the remote control repeatedly to choose VCR mode. TV indicator disappears from the display window.
	<ul style="list-style-type: none"> The video cable is not connected securely. 	<ul style="list-style-type: none"> Connect the video cable securely.
	<ul style="list-style-type: none"> The connected TV power is turned off. 	<ul style="list-style-type: none"> Turn on the TV.
No sound.	<ul style="list-style-type: none"> The Digital Audio Output is set to the wrong position. 	<ul style="list-style-type: none"> Set the Digital Audio Output to the correct position, then turn on the Home Theater System again by pressing POWER.
The playback picture is poor.	<ul style="list-style-type: none"> The disc is dirty. Tape heads are dirty. Tape is a rental or was recorded on another VCR. 	<ul style="list-style-type: none"> Clean the disc. Clean video heads. Use TRK/PRESET (▲/▼) for manual tracking adjustment while tape is playing.
The Home Theater System does not start playback.	<ul style="list-style-type: none"> No disc is inserted. No tape is inserted. 	<ul style="list-style-type: none"> Insert a disc or tape. (Check that the disc or tape indicator in the display window is lit.)
	<ul style="list-style-type: none"> An unplayable disc is inserted. 	<ul style="list-style-type: none"> Insert a playable disc. (Check the disc type, color system, and Regional code.)
	<ul style="list-style-type: none"> The disc is placed upside down. 	<ul style="list-style-type: none"> Place the disc with the playback side down.
	<ul style="list-style-type: none"> The disc is not placed within the guide. 	<ul style="list-style-type: none"> Place the disc on the disc tray correctly inside the guide.
	<ul style="list-style-type: none"> The disc is dirty. 	<ul style="list-style-type: none"> Clean the disc.
The remote control does not work properly.	<ul style="list-style-type: none"> The remote control is not pointed at the remote sensor of the Home Theater System. 	<ul style="list-style-type: none"> Point the remote control at the remote sensor of the Home Theater System.
	<ul style="list-style-type: none"> The remote control is too far from the Combi Receiver. 	<ul style="list-style-type: none"> Operate the remote control within 23 ft (7 m).
	<ul style="list-style-type: none"> There is an obstacle in the path of the remote sensor of the Home Theater System. 	<ul style="list-style-type: none"> Remove the obstacle.
	<ul style="list-style-type: none"> The batteries in the remote control are exhausted. 	<ul style="list-style-type: none"> Replace the batteries with new ones.
	<ul style="list-style-type: none"> This remote control uses the same buttons for VCR and DVD functions (ex. PLAY). 	<ul style="list-style-type: none"> When using a VCR tape, first press the VCR button. When using a DVD, first press the DVD button.

Symptom	Cause	Correction
Some channels are skipped over when using TRK/PRESET (▲/▼)	<ul style="list-style-type: none"> Those channels were deleted with the CH. ADD/DEL option. 	<ul style="list-style-type: none"> Use CH. ADD/DEL. to restore channels. See "Channel Selection" on page 22.
Picture and sound of broadcasting channel are weak or missing.	<ul style="list-style-type: none"> Antenna or cables are loose. 	<ul style="list-style-type: none"> Tighten connections or replace cable.
	<ul style="list-style-type: none"> Wrong TUNING BAND option is being used. 	<ul style="list-style-type: none"> Try all TUNING BAND options. See "Channel Selection" on page 22 for details.
Camcorder image via A/V input to Home Theater System is not shown on TV screen.	<ul style="list-style-type: none"> Home Theater System SOURCE SELECT is not set to L 1 or L 2. 	<ul style="list-style-type: none"> Use INPUT to select LINE input source (L 1 or L 2).
Timer recording is not possible.	<ul style="list-style-type: none"> Clock in Home Theater System is not set to correct time. 	<ul style="list-style-type: none"> Set clock to correct time. See "Setting the Clock" on page 23.
	<ul style="list-style-type: none"> Timer has been programmed incorrectly. 	<ul style="list-style-type: none"> Reprogram Timer. See "Timer Recording" on pages 30 and 31.
	<ul style="list-style-type: none"> Ⓢ indicator does not appear after programming timer. 	<ul style="list-style-type: none"> Reprogram Timer.
Ⓢ indicator appears after Home Theater System is turned off.	<ul style="list-style-type: none"> Home Theater System is in Timer Recording mode. 	<ul style="list-style-type: none"> This is the normal indication that the Home Theater System is in TIMER mode.
Stereo Audio Record and/or Playback is not present.	<ul style="list-style-type: none"> TV is not Stereo-compatible. Broadcast program is not in stereo format. 	<ul style="list-style-type: none"> No action is possible. No action is possible.
	<ul style="list-style-type: none"> Home Theater System BROADCAST TYPE mode is set to SAP or MONO. 	<ul style="list-style-type: none"> Set BROADCAST TYPE mode to STEREO. See "Setting the VCR Setup Menu" on page 22.

Moisture Condensation

Moisture condensation can occur:	In locations where moisture condensation may occur:
<ul style="list-style-type: none"> When the Home Theater System is moved from a cold place to a warm place. Under extremely humid conditions. 	<ul style="list-style-type: none"> Keep the Home Theater System plugged into an AC power outlet with POWER On. This will help prevent condensation. When condensation has occurred, wait a few hours for the Home Theater System to dry before using it.

Specifications

General

Power requirements	AC 120V, 60 Hz
Power consumption	145W
Dimensions (approx.)	430 X 90 X 350 mm (16.9 x 3.5 x 13.8 inches) (w x h x d)
Weight (approx.)	8 kg (17.6 lbs)
Operating temperature	5°C to 35°C
Operating humidity	5 % to 90 %
Signal system	NTSC

Inputs

ANTENNA IN	Antenna or CATV input, 75 ohms
VHS VIDEO IN(LINE1, 2)	1 Vp-p 75 ohms, sync negative, RCA jack x 2
VHS AUDIO IN(LINE1, 2)	-6.0 dBm more than 47 ohms, RCA jack (L, R) x 2

Outputs

MONITOR OUT	1 Vp-p 75 ohms, sync negative
S-VIDEO OUT	(Y) 1.0 V (p-p), 75 ohms, negative sync, Mini DIN 4-pin x 1 (C) 0.3 V (p-p) 75 ohms
Component Video output	(Y) 1.0 V (p-p), 75 Ω, negative sync., RCA jack x 1 (Pb)/(Pr) 0.7 V (p-p), 75 Ω, RCA jack x 1

VCR Specifications

Head system	Four head helical scan azimuth system
Timer	12-hour display type with AM, PM
Tape speed	SP: 33.35 mm/sec, LP: 16.67 mm/sec, SLP: 11.12 mm/sec
Tape width	12.7 mm
Maximum recording time	SP: 2 HOURS (T-120), SLP: 6 HOURS (T-120)/8 HOURS (T-160)
Rewind time	About 3 minutes (T-120)
Antenna	75 ohms (VHF/UHF)
VHF output signal	Channel 3 or 4
Channel coverage	VHF: 2-13, UHF: 14-69, CATV: 1-125 (4A, A-W, W+1 - W+84, A-5 - A-1)
Frequency range	200Hz to 8kHz
Signal-to-noise ratio	More than 65 dB (EE mode)
Dynamic range	More than 70 dB (EE mode)
Channel separation	More than 45 dB (EE mode)

DVD Specifications

Laser system	Semiconductor laser, wavelength 650 nm
Frequency response	DVD (PCM 96 kHz): 20 Hz to 44 kHz, DVD (PCM 48 kHz): 20 Hz to 22 kHz CD: 20 Hz to 18 kHz
Signal-to-noise ratio	More than 70 dB
Harmonic distortion	Less than 0.5 %
Dynamic range	More than 65 dB (DVD/CD)

Tuner section

System	PLL quartz-locked digital synthesizer system
Tuning range	87.5 ~ 108.0 MHz (FM) 520 ~ 1720 KHz (AM)
Antenna	Wire antenna (FM) Loop antenna (AM)

Amplifier

Stereo mode	180W + 180W (4Ω at 1 kHz, THD 10 %)
Surround mode	Front: 180W + 180W (THD 10 %)
(* Depending on the sound mode settings and the source, there may be no sound output.)	Center*: 180W
	Surround*: 180W + 180W (4Ω at 1 kHz, THD 10 %)
	Subwoofer*: 300W (3Ω at 30 Hz, THD 10 %)
Antenna	Wire antenna (FM)
	Loop antenna (AM)

Speakers

Satellite (LHS-95SBS)

Type	1 Way 1 Speaker
Impedance	4 Ω
Frequency Response	110 - 20,000 Hz
Sound Pressure Level	83 dB/W (1m)
Max Input Power	180W
Net Dimensions (W x H x D)	140 x 222 x 153 mm
Net Weight	0.95 kg

Center (LHS-95SBC)

Type	1 Way 1 Speaker
Impedance	4 Ω
Frequency Response	110 - 20,000 Hz
Sound Pressure Level	83 dB/W (1m)
Max Input Power	180W
Net Dimensions (W x H x D)	300 x 116 x 91 mm
Net Weight	1.0 kg

Subwoofer (LHS-95SBW)

Type	1 Way 1 Speaker
Impedance	3 Ω
Frequency Response	40 - 1,500 Hz
Sound Pressure Level	82 dB/W (1m)
Max Input Power	300W
Net Dimensions (W x H x D)	180 x 400 x 355 mm
Net Weight	5.6 kg

Accessories:

Video cable x 1, Audio cable x 1, RF 75-ohm Coaxial Cable x 1, Speaker cable x 6, FM Antenna cable x 1, AM Antenna cable x 1, Remote control x 1, Batteries (AAA) x 2

- Design and specifications are subject to change without prior notice.



**LG Electronics, Inc.
Combi Receiver -LHX-557
Limited Warranty - USA**

This LG Electronics product, marketed by Zenith, will be repaired or replaced, at LG's option, if it proves to be defective in material or workmanship, under normal use, during the warranty period ("Warranty Period") listed below, effective from the date ("Date of Purchase") of original consumer purchase of the product. This warranty is good only to the original purchaser of the product and effective only when used in the United States, excluding U.S. Territories.

WARRANTY PERIOD: LABOR: 90 days from the Date of Purchase. PARTS: One Year from the Date of Purchase. * Parts replaced are warranted for the remaining portion of the original warranty period.	HOW SERVICE IS HANDLED: Call 1-800-243-0000 for instructions on getting the defective unit repaired or replaced. Please retain dated sales receipt and your box to return the unit to LG for repair or replacement. Shipping both ways will be paid by LG during the first 90 days of the Warranty Period. During the remainder of the Warranty Period (91-365 days), you pay inbound shipping charges and LG pays return shipping charges. Visit our website at: http://www.lgservice.com
---------------------------------------------------------------------------------------------------------------------------------------------------------------------------------------------------------------------------------------	------------------------------------------------------------------------------------------------------------------------------------------------------------------------------------------------------------------------------------------------------------------------------------------------------------------------------------------------------------------------------------------------------------------------------------------------------------------------------------------------------------------------------------------------------------------------------------

THIS WARRANTY IS IN LIEU OF ANY OTHER WARRANTIES, EXPRESS OR IMPLIED, INCLUDING WITHOUT LIMITATION, ANY WARRANTY OF MERCHANTABILITY OR FITNESS FOR A PARTICULAR PURPOSE. TO THE EXTENT ANY IMPLIED WARRANTY IS REQUIRED BY LAW, IT IS LIMITED IN DURATION TO THE EXPRESS WARRANTY PERIOD ABOVE. LG ELECTRONICS WILL NOT BE LIABLE FOR ANY INCIDENTAL, CONSEQUENTIAL, INDIRECT, SPECIAL OR PUNITIVE DAMAGES OF ANY NATURE, EVEN IF ADVISED OF THE POSSIBILITY OF SUCH DAMAGES, INCLUDING WITHOUT LIMITATION, LOST REVENUES OR PROFITS, LOST OR CORRUPTED PROGRAMMING OR DATA, OR ANY OTHER DAMAGE WHETHER BASED IN CONTRACT, TORT OR OTHERWISE. Some states do not allow the exclusion or limitation of incidental or consequential damages or limitation on how long an implied warranty lasts, so the above exclusion or limitation may not apply to you. This warranty gives you specific legal rights and you may also have other rights that may vary from state to state.

THIS LIMITED WARRANTY DOES NOT APPLY TO:

- Damages or operating problems that result from shipping, installation, adjustment of user controls, calibration, maintenance or failure to maintain, or separate system components; and
- Damages or operating problems that result from normal wear and tear, misuse, abuse, operation outside environmental specifications or contrary to the requirements or precautions in the Operating Guide, accident, lightning strikes or other natural causes, unauthorized modification or alteration, incorrect electrical current or voltage, reception problem caused by inadequate home antenna or faulty antenna connections, computer software, institutional or commercial use, or other causes not arising out of defect in material or workmanship.

Therefore, the cost of repair or replacement of such defective product shall be borne by the consumer.

CUSTOMER INTER-ACTIVE CENTER NUMBERS:

For nearest Authorized Service Center, Where to buy, Product Assistance, or Customer Assistance	Call 1-800-243-0000 (24 hours a day, 365 days per year) and select appropriate options from the menu. Or visit our website at http://www.lgservice.com
--------------------------------------------------------------------------------------------------------	-------------------------------------------------------------------------------------------------------------------------------------------------------------------------------------------------------------

LG Electronics U.S.A., Inc.
1000 Sylvan Avenue, Englewood Cliffs, NJ.

GS# 3834RH0075E
Printed in Indonesia
Issue O

Free Manuals Download Website

<http://myh66.com>

<http://usermanuals.us>

<http://www.somanuals.com>

<http://www.4manuals.cc>

<http://www.manual-lib.com>

<http://www.404manual.com>

<http://www.luxmanual.com>

<http://aubethermostatmanual.com>

Golf course search by state

<http://golfingnear.com>

Email search by domain

<http://emailbydomain.com>

Auto manuals search

<http://auto.somanuals.com>

TV manuals search

<http://tv.somanuals.com>