



# HD Receiver / DVD Player

## OWNER'S MANUAL

MODEL : LST-3510A



**MP3**



Before connecting, operating or adjusting this product,  
please read this instruction manual carefully and completely.

HIGH DEFINITION TELEVISION  
**HDTV**  
TUNER

## Safety Precautions



**CAUTION**  
RISK OF ELECTRIC SHOCK  
DO NOT OPEN



**CAUTION:** TO REDUCE THE RISK OF ELECTRIC SHOCK DO NOT REMOVE COVER (OR BACK) NO USER-SERVICEABLE PARTS INSIDE REFER SERVICING TO QUALIFIED SERVICE PERSONNEL.



This lightning flash with arrowhead symbol within an equilateral triangle is intended to alert the user to the presence of uninsulated dangerous voltage within the product's enclosure that may be of sufficient magnitude to constitute a risk of electric shock to persons.



The exclamation point within an equilateral triangle is intended to alert the user to the presence of important operating and maintenance (servicing) instructions in the literature accompanying the product.

**WARNING:** TO REDUCE THE RISK OF FIRE OR ELECTRIC SHOCK, DO NOT EXPOSE THIS PRODUCT TO RAIN OR MOISTURE.

**CAUTION:** TO PREVENT ELECTRIC SHOCK, MATCH WIDE BLADE OF PLUG TO WIDE SLOT, FULLY INSERT.

**ATTENTION:** POUR ÉVITER LES CHOC ÉLECTRIQUES, INTRODUIRE LA LAME LA PLUS LARGE DE LA FICHE DANS LA BORNE CORRESPONDANTE DE LA PRISE ET POUSSER JUSQU'AU FOND.

**WARNING:** Do not install this equipment in a confined space such as a book case or similar unit.

CLASS 1 LASER PRODUCT  
KLASSE 1 LASER PRODUKT  
LUOKAN 1 LASER LAITE  
KLASS 1 LASER APPARAT  
CLASSE 1 PRODUIT LASER

### CAUTION:

This DVD/HDTV Receiver employs a Laser System.

To ensure proper use of this product, please read this owner's manual carefully and retain for future reference, should the unit require maintenance, contact an authorized service location-see service procedure.

Use of controls, adjustments or the performance of procedures other than those specified herein may result in hazardous radiation exposure.

To prevent direct exposure to laser beam, do not try to open the enclosure. Visible laser radiation when open. DO NOT STARE INTO BEAM.

**CAUTION:** The apparatus shall not be exposed to water, dripping or splashing and that no objects filled with liquids, such as vases, shall be placed on the apparatus.

**FCC WARNING:** This equipment may generate or use radio frequency energy. Changes or modifications to this equipment may cause harmful interference unless the modifications are expressly approved in the instruction manual. The user could lose the authority to operate this equipment if an unauthorized change or modification is made.

### NOTE TO CABLE/TV INSTALLER

This reminder is provided to call the cable TV system installer's attention to Article 820-40 of the National Electric Code (U.S.A.). The code provides guidelines for proper grounding and, in particular, specifies that the cable ground shall be connected to the grounding system of the building, as close to the point of the cable entry as practical.

### REGULATORY INFORMATION: FCC Part 15

This product has been tested and found to comply with the limits for a Class B digital device, pursuant to Part 15 of the FCC Rules. These limits are designed to provide reasonable protection against harmful interference when the product is operated in a residential installation. This product generates, uses and can radiate radio frequency energy and, if not installed and used in accordance with the instruction manual, may cause harmful interference to radio communications. However, there is no guarantee that interference will not occur in a particular installation. If this product does cause harmful interference to radio or television reception, which can be determined by turning the product off and on, the user is encouraged to try to correct the interference by one or more of the following measures:

- Reorient or relocate the receiving antenna.
- Increase the separation between the product and receiver.
- Connect the product into an outlet on a circuit different from that to which the receiver is connected.
- Consult the dealer or an experienced radio/TV technician for help.

### CAUTION

DO NOT ATTEMPT TO MODIFY THIS PRODUCT IN ANY WAY WITHOUT WRITTEN AUTHORIZATION FROM ZENITH ELECTRONICS CORPORATION. UNAUTHORIZED MODIFICATION COULD VOID THE USER'S AUTHORITY TO OPERATE THIS PRODUCT.

THIS EQUIPMENT IS INTENDED TO RECEIVE AND DECODE SIGNALS TRANSMITTED ACCORDING TO ATSC DIGITAL TELEVISION STANDARD A/53, SPECIFICATION AND IS INTENDED TO BE USED WITH AN APPROPRIATE ANTENNA AND DISPLAY DEVICE THAT YOU MUST PROVIDE.

### Notes on copyrights:

It is forbidden by law to copy, broadcast, show, broadcast via cable, play in public, or rent copyright material without permission.

This product features the copy protection function developed by Macrovision. Copy protection signals are recorded on some discs. When recording and playing the pictures of these discs on a VCR, the picture noise will appear.

This product incorporates copyright protection technology that is protected by method claims of certain U.S. patents and other intellectual property rights owned by Macrovision Corporation and other rights owners. Use of this copyright protection technology must be authorized by Macrovision Corporation, and is intended for home and other limited viewing uses only unless otherwise authorized by Macrovision Corporation. Reverse engineering or disassembly is prohibited.

**SERIAL NUMBER:** Locate the serial number on the back of the unit. This number is only used on this unit. You should write in requested information below and retain this guide as a permanent record of your purchase.

Model No. LST-3510A

Serial No. \_\_\_\_\_

Date of Purchase \_\_\_\_\_

# IMPORTANT SAFETY INSTRUCTIONS

**CAUTION: PLEASE READ AND OBSERVE ALL WARNINGS AND INSTRUCTIONS IN THIS INSTALLATION AND OPERATING GUIDE AND THOSE MARKED ON THE UNIT. RETAIN THIS GUIDE FOR FUTURE REFERENCE.**

This set has been designed and manufactured to assure personal safety. Improper use can result in electric shock or fire hazard. The safeguards incorporated in this unit will protect you if you observe the following procedures for installation, use, and servicing.

This unit does not contain any parts that can be repaired by the user.

**DO NOT REMOVE THE CABINET COVER, OR YOU MAY BE EXPOSED TO DANGEROUS VOLTAGE. REFER SERVICING TO QUALIFIED SERVICE PERSONNEL ONLY.**

- 1. Read these instructions.** - All these safety and operating instructions should be read before the product is operated.
- 2. Keep these instructions.** - The safety, operating and use instructions should be retained for future reference.
- 3. Heed all warnings.** - All warnings on the product and in the operating instructions should be adhered to.
- 4. Follow all instructions.** - All operating and use instructions should be followed.
- 5. Do not use this apparatus near water.** - For example: near a bath tub, wash bowl, kitchen sink, laundry tub, in a wet basement; near a swimming pool; etc.
- 6. Clean only with dry cloth.** - Unplug this product from the wall outlet before cleaning. Do not use liquid cleaners.
- 7. Do not block any ventilation openings. Install in accordance with the manufacturer's instructions.** - Slots and openings in the cabinet are provided for ventilation, to ensure reliable operation of the product, and to protect it from over-heating. The openings should never be blocked by placing the product on a bed, sofa, rug or other similar surface. This product should not be placed in a built-in installation such as a bookcase or rack unless proper ventilation is provided and the manufacturer's instructions have been adhered to.
- 8. Do not install near any heat sources such as radiators, heat registers, stoves, or other apparatus (including amplifiers) that produce heat.**
- 9. Do not defeat the safety purpose of the polarized or grounding-type plug.** A polarized plug has two blades with one wider than the other. A grounding type plug has two blades and a third grounding prong. The wide blade or the third prong are provided for your safety. If the provided plug does not fit into your outlet, consult an electrician for replacement of the obsolete outlet.
- 10. Protect the power cord from being walked on or pinched particularly at plugs, convenience receptacles, and the point where they exit from the apparatus.**
- 11. Only use attachments/accessories specified by the manufacturer.**
- 12. Use only the cart, stand, tripod, bracket, or table specified by the manufacturer, or sold with apparatus. When a cart is used, use caution when moving the cart/ apparatus combination to avoid injury from tip-over.**
- 13. Unplug this apparatus during lightning storms or when unused for long periods of time.**
- 14. Refer all servicing to qualified service personnel. Servicing is required when the apparatus has been damaged in any way, such as power-supply cord or plug is damaged, liquid has been spilled or objects have fallen into the apparatus, the apparatus has been exposed to rain or moisture, does not operate normally, or has been dropped.**



# Table of Contents

## INTRODUCTION

Safety Precautions .....	2
<b>IMPORTANT SAFETY INSTRUCTIONS</b> .....	<b>3</b>
<b>Table of Contents</b> .....	<b>4</b>
<b>Pre-operation Overview</b> .....	<b>5-6</b>
Playable Discs .....	5
Precautions .....	6
Notes on Discs .....	6
About Symbols .....	6
<b>Front Panel Controls</b> .....	<b>7</b>
<b>Display Window</b> .....	<b>8</b>
<b>Remote Control Key Functions</b> .....	<b>9</b>
<b>Unpacking DVD/HDTV Receiver and Accessories/Connection Overview</b> .....	<b>10</b>
<b>Connection Panel Overview</b> .....	<b>11</b>

## INSTALLATION

<b>Connections</b> .....	<b>12-18</b>
Antenna Connections .....	12
Analog Monitor Connections .....	13
HD Monitor Component (YPbPr) Connections ..	14
HD Monitor RGB Connections .....	15
HD Monitor DVI-HDTV Connections .....	16
VCR Connections .....	17
Amplifier (Receiver) Connections .....	18
<b>Display Format Setup</b> .....	<b>19</b>

## DTV MENU OPERATION

<b>Pre-operation Setup</b> .....	<b>20</b>
General Operation .....	20
<b>Setup Menu Options</b> .....	<b>21-23</b>
EZ Scan (Channel Search) .....	21
Ch. Edit (Channel Edit) .....	22
DTV Signal .....	22
EZ Demo .....	23
Channel Labels .....	23
<b>Option Menu Features</b> .....	<b>24-27</b>
Clock .....	24
Menu Language .....	24
Audio Language .....	24
Aspect Ratio .....	25
Choosing the Aspect Ratio .....	26
Digital Audio Output .....	27
<b>Caption Menu</b> .....	<b>28-30</b>
Caption (DTV) .....	28
Caption Style (DTV) .....	29
Caption (Analog) .....	30
<b>Lock (Parental Control) Menu Options</b> .....	<b>31-35</b>
Lock System .....	31
Set Password .....	31
Block Ch. (Channel) .....	32
Movie Rating .....	33
TV Rating-Children .....	34
TV Rating-General .....	35
<b>GUIDE Options</b> .....	<b>36</b>
Program Guide .....	36
Station Guide .....	36
<b>Information Displays</b> .....	<b>37-38</b>
Channel Banner Display .....	37
Program Information Display .....	38

## DTV OPERATION

<b>Program and Station Guide</b> .....	<b>39</b>
<b>Normal Operation</b> .....	<b>40</b>
Channel Selection .....	40
Volume Adjustment .....	40
Signal .....	40

## DVD MENU OPERATION

<b>DVD On-screen Display</b> .....	<b>41</b>
General Explanation .....	41
On-Screen Displays .....	41
<b>Initial Settings</b> .....	<b>42-43</b>
Initial Settings General Operation .....	42
Language .....	42
Picture .....	42
Sound .....	43
Others .....	43
Parental Control .....	44

## DVD OPERATION

<b>DVD and Video CD Operation</b> .....	<b>45-48</b>
Playing a DVD or Video CD .....	45
General Features .....	45-47
Special DVD Features .....	47
<b>Audio CD and MP3/WMA Disc Operation</b> .....	<b>48-49</b>
Playing an Audio CD or MP3/WMA Disc .....	48
Notes on MP3/WMA Recordings .....	48
General Features .....	49
<b>JPEG File Operation</b> .....	<b>50</b>
Viewing JPEG files on a disc .....	50
<b>Programmed Playback</b> .....	<b>51</b>
Audio CD Programmed Playback MP3/WMA Discs ..	51
Video CD Programmed Playback .....	51
<b>DVD Additional Information</b> .....	<b>52</b>
Last Condition Memory .....	52
Video Mode Setting .....	52
HDCD Playback .....	52

## REFERENCE

<b>Programming the Remote Control to Operate Other Devices</b> .....	<b>53</b>
<b>Remote Control Codes for Other Devices</b> .....	<b>54-55</b>
<b>DTV Troubleshooting</b> .....	<b>56</b>
<b>DVD Troubleshooting</b> .....	<b>57</b>
<b>Language Code List</b> .....	<b>58</b>
<b>Country Code List</b> .....	<b>59</b>
<b>Specifications</b> .....	<b>60</b>
<b>Notes</b> .....	<b>61-63</b>
<b>Warranty</b> .....	<b>Back Cover</b>

## About the symbols for instructions



 Indicates hazards likely to cause harm to the unit itself or other material damage.

 Indicates special operating features of this unit.

 Indicates tips and hints for making the task easier.

## Pre-operation Overview

### Playable Discs

	DVD (8 cm / 12 cm disc)
	Video CD (VCD) (8 cm / 12 cm disc)
	Audio CD (8 cm / 12 cm disc)

In addition, this unit can play HDCD, DVD-R, DVD±RW, Kodak PICTURE CD, SVCD, CD-R, or CD-RW that contain audio titles, MP3, WMA, or JPEG files.

#### Notes

- Depending on the conditions of the recording equipment or the CD-R/RW (or DVD-R/±RW) disc itself, some CD-R/RW (or DVD-R/±RW) discs cannot be played on the unit.
- Do not attach any seal or label to either side (the labeled side or the recorded side) of a disc.
- Do not use irregularly shaped CDs (e.g., heart-shaped or octagonal). The unit may malfunction.

#### Notes on DVDs and Video CDs

Some playback operations of DVDs and Video CDs may be intentionally fixed by software manufacturers. As this unit plays DVDs and Video CDs according to disc content designed by the software manufacturer, some playback features of the unit may not be available or other functions may be added.

Refer also to the instructions supplied with the DVDs and Video CDs. Some DVDs made for business purposes may not be played on the unit.

#### Regional code of the DVD/HDTV Receiver and DVDs

This DVD/HDTV Receiver is designed and manufactured for playback of region “1” encoded DVD software. The regional code on the labels of some DVD discs indicates which type of DVD player can play those discs. This unit can play only DVD discs labeled “1” or “ALL”. If you try to play any other discs, the message “Check Regional Code” will appear on the TV screen. Some DVD discs may not have a region code label even though their playback is prohibited by area limits.



### Disc-related terms

#### Title (DVD video discs only)

The main film content, accompanying feature content, additional feature content, or music album. Each title is assigned a title reference number enabling you to locate it easily.

#### Chapter (DVD only)

Sections of a picture or a musical piece that are smaller than titles. A title is composed of one or several chapters. Each chapter is assigned a chapter number, enabling you to locate the chapter you want. Depending on the disc, chapters may not be recorded.

#### Track (Video CD and audio CD only)

Sections of a picture or a musical piece on a video CD or an audio CD. Each track is assigned a track number, enabling you to locate the track you want.

#### Scene

On a video CD with PBC (Playback control) functions, moving pictures and still pictures are divided into sections called “Scenes”. Each scene is displayed on the menu display and assigned a scene number, enabling you to locate the scene you want.

A scene is composed of one or several tracks.

#### Types of video CDs

There are two types of video CDs:

##### Video CDs equipped with PBC (Version 2.0)

PBC (Playback control) functions allow you to interact with the system via menus, search functions, or other typical computer-like operations. Moreover, still pictures of high resolution can be played if they are included in the disc.

##### Video CDs not equipped with PBC (Version 1.1)

Operated in the same way as audio CDs, these discs allow playback of video pictures as well as sound, but they are not equipped with PBC.

#### HDCD (High Definition Compatible Digital®)

HDCD® (High Definition Compatible Digital®) is a recording system that has improved audio CD sound in dynamic range, sound field reproducibility and vocal acoustics.

This DVD/HDTV Receiver is equipped with an HDCD decoder. The HDCD indicator illuminates when playing an HDCD-encoded audio CD.

HDCD®, HDCD®, High Definition Compatible Digital® and Pacific Microsonics™ are either registered trademarks or trademarks of Pacific Microsonics, Inc. in the United States and/or other countries. HDCD system manufactured under license from Pacific Microsonics, Inc. This product is covered by one or more of the following patents: United States: 5,479,168, 5,638,074, 5,640,161, 5,808,574, 5,838,274, 5,854,600, 5,872,531 and 5,864,311. Australia: 669114. Other patents pending.

## Pre-operation Overview (Continued)

### Precautions

#### Handling the unit

##### When shipping the unit

The original shipping carton and packing materials come in handy. For maximum protection, re-pack the unit as it was originally packed at the factory.

##### When setting up the unit

The picture and sound of a nearby TV, VCR, or radio may be distorted during playback. In this case, position the unit away from the TV, VCR, or radio, or turn off the unit after removing the disc.

##### To keep the exterior surfaces clean

Do not use volatile liquids, such as insecticide spray, near the unit. Do not leave rubber or plastic products in contact with the unit for a long period of time. They will leave marks on the surface.

#### Cleaning the unit

##### To clean the cabinet

Use a soft, dry cloth. If the surfaces are extremely dirty, use a soft cloth lightly moistened with a mild detergent solution. Do not use strong solvents such as alcohol, benzene, or thinner, as these might damage the surface of the unit.

##### To obtain a clear picture

The DVD/HDTV Receiver is a high-tech, precision device. If the optical pick-up lens and disc drive parts are dirty or worn, the picture quality will be poor. Regular inspection and maintenance are recommended after every 1,000 hours of use. (This depends on the operating environment.)

For details, please contact your nearest dealer.

### Notes on Discs

#### Handling discs

Do not touch the playback side of the disc. Hold the disc by the edges so that fingerprints will not get on the surface. Do not stick paper or tape on the disc.



#### Storing discs

After playing, store the disc in its case.

Do not expose the disc to direct sunlight or sources of heat, or leave it in a parked car exposed to direct sunlight, as there may be a considerable temperature increase inside the car.

#### Cleaning discs

Fingerprints and dust on the disc can cause poor picture quality and sound distortion. Before playing, clean the disc with a clean cloth. Wipe the disc from the center out.

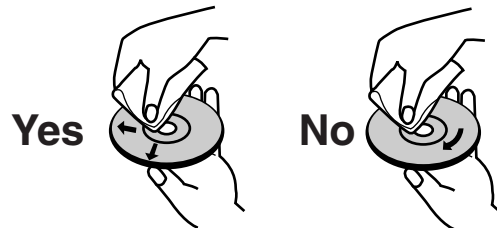

Do not use strong solvents such as alcohol, benzene, thinner, commercially available cleaners, or anti-static spray intended for older vinyl records.

### About Symbols

#### About the symbol display

"" may appear on the TV screen during operation. This icon means the function explained in this owner's manual is not available on that specific DVD video disc.

#### About the disc symbols for instructions

A section whose title has one of the following symbol is applicable only to the disc represented by the symbol.

 DVD

 Video CDs with the PBC (playback control) function

 Video CDs without the PBC (playback control) function

 Audio CDs

 MP3 disc

 WMA disc

 JPEG Files



## Front Panel Controls

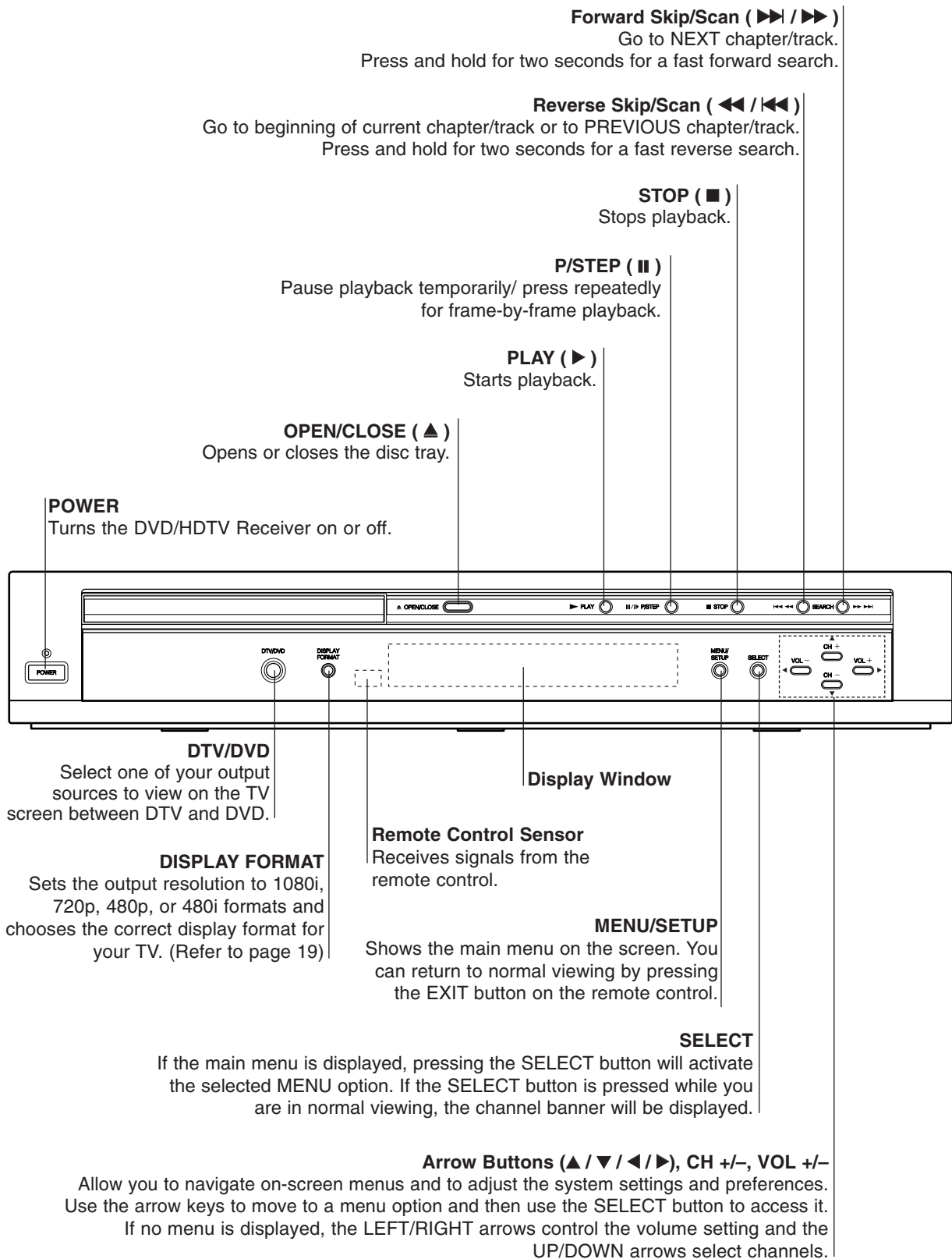

# Display Window

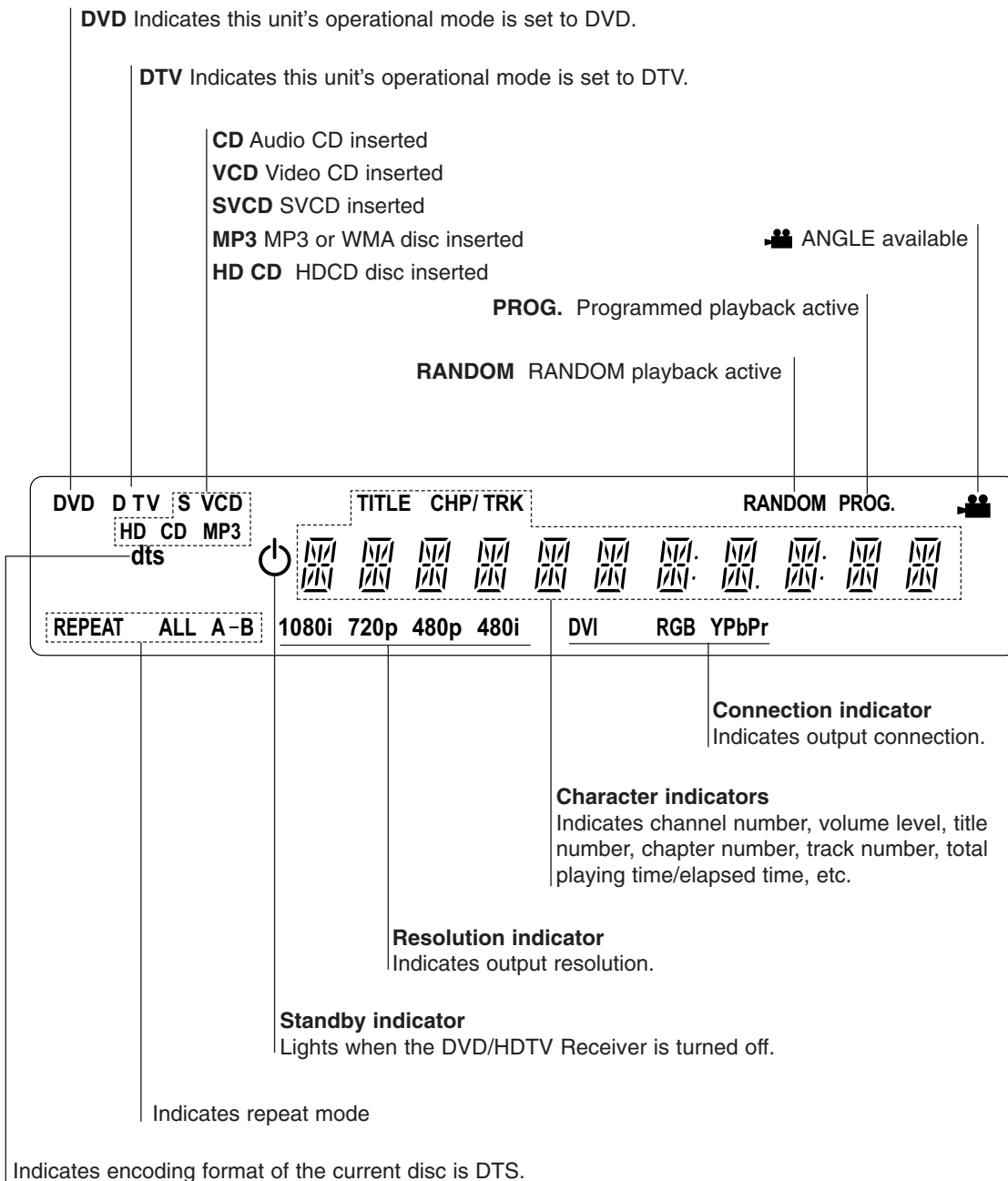



## Remote Control Key Functions

**DTV/DVD (TV/INPUT)**  
Select one of your output sources to view on the TV screen between DTV and DVD. To select the TV's source (Tuner or AUX A/V input).

**RATIO**  
Changes the picture aspect ratio.

**GUIDE**  
Brings up the Program Guide.

**SURF**  
Tunes to your surf channels.

**SIGNAL**  
Shows the signal strength of the current channel.

**INFO**  
Shows the current station and program information on the screen.

**FLASHBK**  
Returns to the last channel viewed.

**Dash (-)**  
Enters a channel number for multiple program channels such as 2-1, 2-2, etc.

**OPEN/CLOSE**  
Opens and closes the disc tray.

**STOP (■)**  
Stops playback.

**PAUSE/STEP (||)**  
Pauses playback temporarily/ press repeatedly for frame-by-frame playback.

**PLAY (▷)**  
Starts playback.

**MENU/SETUP**  
Accesses or closes main menu.

**EXIT**  
Removes all on-screen displays and returns to TV viewing from any menu.

**DISPLAY**  
Accesses On-Screen display.

**DISC MENU**  
Accesses menu on a DVD disc.

**TITLE**  
Displays the discs Title menu, if available.

**MARKER**  
Marks any point during playback.

**SEARCH**  
Displays MARKER SEARCH menu.

**ANGLE**  
Selects a DVD camera angle if available

**PROGRAM**  
Enters / exits the program edit mode.

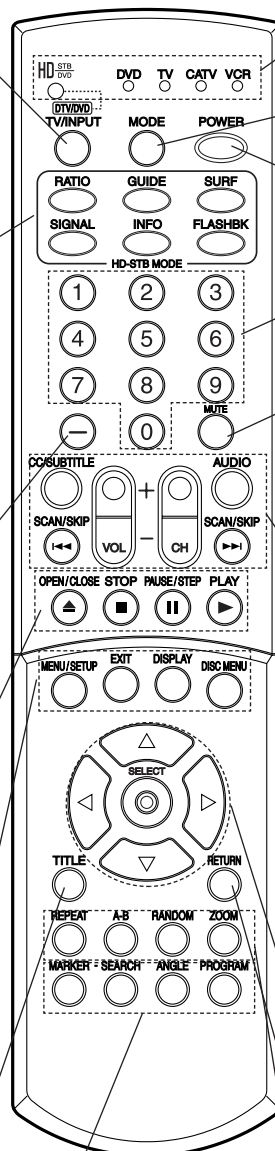

**Mode Indicator**  
Indicates the remote control operational mode.

**MODE**  
Selects operational mode of remote control.

**POWER**  
Turns the DVD/HDTV Receiver ON and OFF.

**Numbers**  
Chooses channels and enters programming information.

**MUTE**  
Turns sound ON and OFF.

**CC/SUBTITLE**  
Selects caption mode or subtitle language if available.

**VOL (Volume) (+/-)**  
Changes volume.

**CH (Channel) (+/-)**  
Selects a memorized channels.

**AUDIO**  
Selects program's audio language options. Selects an audio language (DVD) or an audio channel (CD).

**Forward SCAN/SKIP (▶▶)**  
Search forward\*/ go to next chapter or track.

**Reverse SCAN/SKIP (◀◀)**  
Search backward\*/ go to beginning of current chapter or track or go to previous chapter or track.

\* Press and hold button for about two seconds.

**Arrow Buttons (▲/▼/◀/▶)**  
Select menu options.

**SELECT (◎)**  
Completes the channel number input and promptly tunes to selected channel. Acknowledges menu selection.

**RETURN**  
- Removes the Setup menu.  
- Displays the menu of a video CD with PBC.

**REPEAT**  
Repeat chapter, track, title, all.

**A-B**  
Repeat sequence.

**RANDOM**  
Plays tracks in random order.

**ZOOM**  
Enlarges video image.

# Unpacking DVD/HDTV Receiver and Accessories/Connection Overview

Make sure you have received all the accessories listed below with the High Definition Television Receiver.

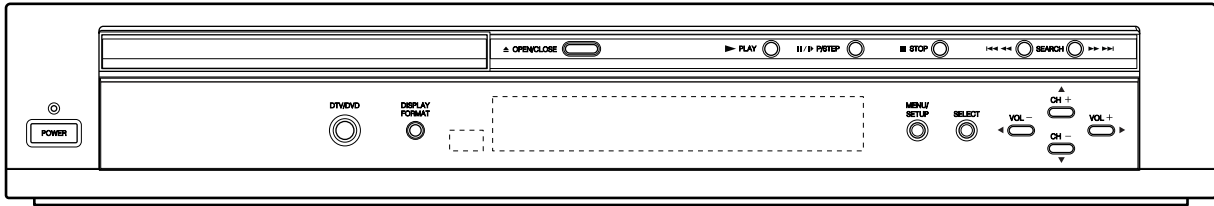

## HDTV Receiver / DVD Player

The DVD/HDTV Receiver is capable of receiving signals from cable and/or over-the-air antenna sources and sending the signals to your TV.

**Included with the Receiver are the following accessories.**

- Audio Cable/Video Cable/Component(YPbPr) Cable
- RF Cable
- Remote Control and 2 AA Batteries

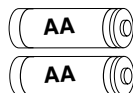
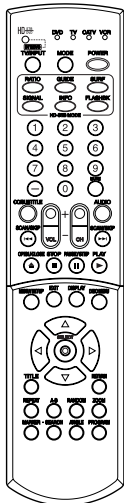
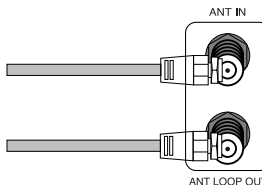
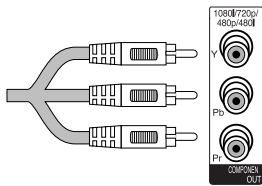
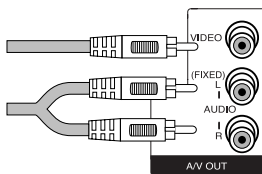

## Audio/Video Jacks and Cables

The Audio/Video jacks provide excellent picture and sound quality. They are used for making most Audio/Video connections between components. The Audio/Video jacks may be color coded (yellow for video, red for right audio, and white for left audio). If your component has only one input for audio (mono), connect it to the left (white L/mono) audio jack on the DVD/HDTV Receiver.

## Component Out Jacks and Cables

Component Cables are used to connect the DVD/HDTV Receiver to an industry standard YPbPr compatible HD Monitor (green for Y, blue for Pb, and red for Pr). Remember to connect the left and right audio cables. The YPbPr Component jacks carry only the picture signals, not the sound.

## ANT LOOP OUT Jack and RF Cable

ANT LOOP OUT provides the signal from the ANT IN RF connection on the DVD/HDTV Receiver to the TV.

## Remote Control

In addition to the DVD/HDTV Receiver, the remote control can be programmed to control many other devices.

## Batteries

To install the batteries, slide open the battery compartment and insert the two AA batteries provided.

## Remote Control Operation Range

Point the remote control at the remote sensor and press the buttons.

- **Distance:** About 23 ft (7 m) from the front of the remote sensor.
- **Angle:** About 30° in each direction of the front of the remote sensor.

## Remote Control Battery Installation

Detach the battery cover on the rear of the remote control, and insert two batteries (size AA) with + and - aligned correctly.



**Caution**  
Do not mix old and new batteries. Never mix different types of batteries (standard, alkaline, etc.).

## Connection Panel Overview

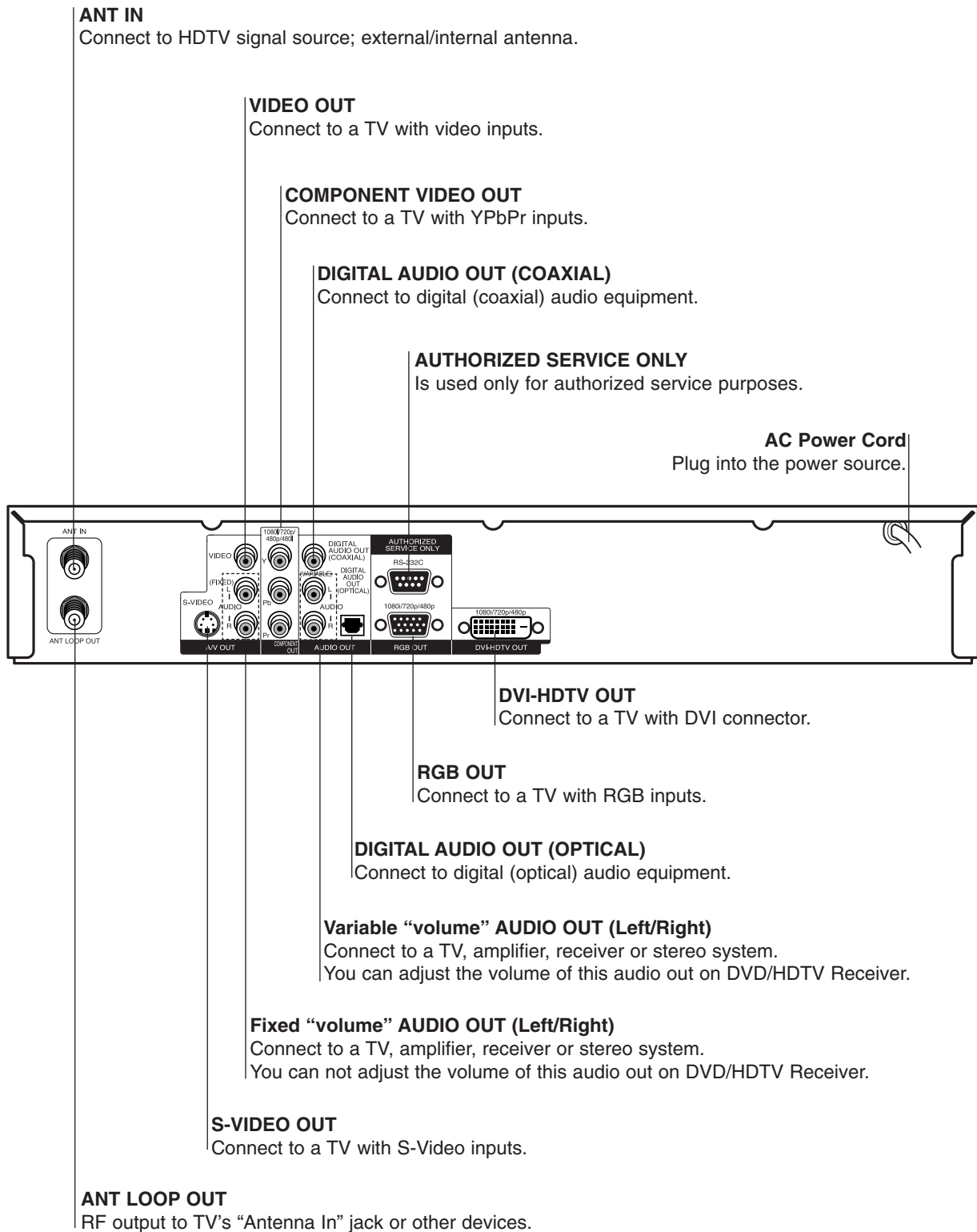

**Do not touch the inner pins of the jacks on the rear panel.**  
**Electrostatic discharge may cause permanent damage to the unit.**

## Connections

### Antenna Connections

- 1 Connect the "Antenna" to the "ANT IN" jack on the DVD/HDTV Receiver using a coaxial RF cable.

#### Note

There might be some areas where the signal strength could be too high. If so, you may need to connect the antenna to the optional attenuator and screw the attenuator onto the "ANT IN" jack.

- 2 Connect the "ANT LOOP OUT" jack on the DVD/HDTV Receiver to the "Antenna In" jack on your TV using a coaxial RF cable.

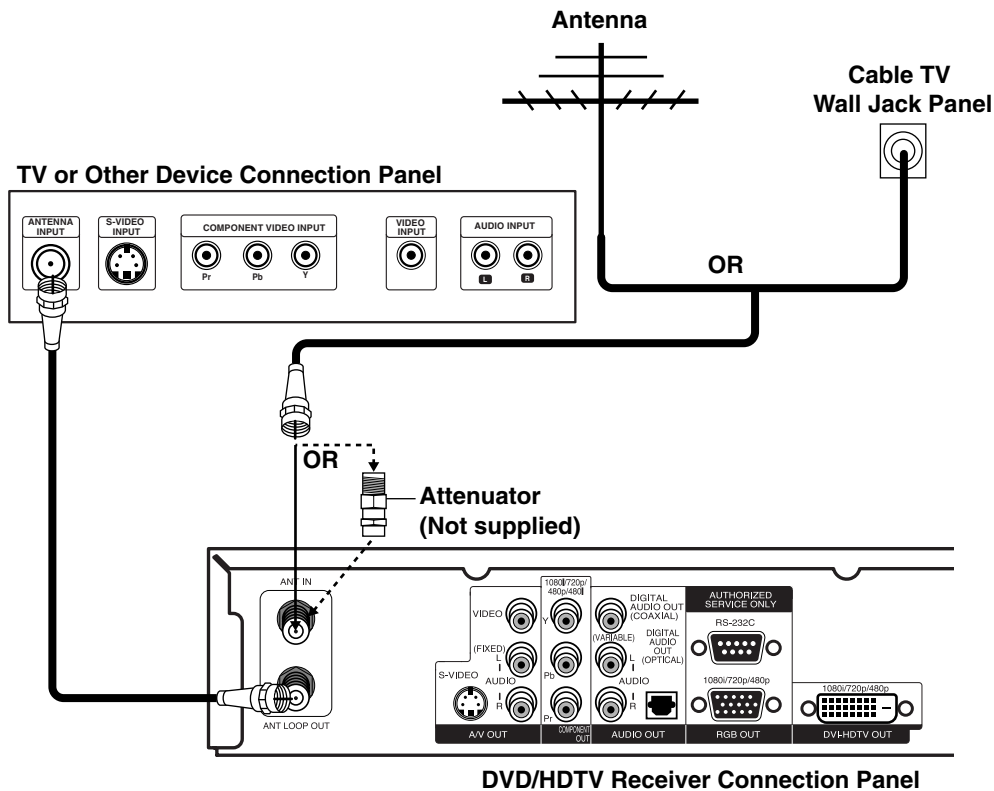

#### Tip

##### Before Connecting Your Antenna

[Dear consumer purchaser of High Definition Television Receiver LST-3510A.](#)

During initial installation and setup of your DVD/HDTV Receiver, you may need to install an optional 10 dB attenuator to the Antenna input "ANT IN" on the LST-3510A. The LST-3510A is a high performance, high-gain system intended for operation under normal and weak signal conditions, providing the best reception with its optimum gain. However, there might be some reception areas where the signal strength is too high (e.g. due to close proximity to an undesirable signal or transmitter), so you need an attenuator that lowers the incoming signal strength (from the undesirable transmitter) to more normal levels. This 10 dB attenuator should be used only in a reception area where the undesired signal strength is too high. One of the possible symptoms would be that after your program/channel search, your DVD/HDTV Receiver does not find all the local digital terrestrial channels available in your area. (You can find HDTV channels/content information for your local broadcast area by going to Zenith website "WWW.ZENITH.COM" and clicking on "HDTV Program Schedule" under HDTV.) Please make sure that before deciding to use an optional attenuator device, you are using an appropriate and properly aligned UHF/VHF RF terrestrial antenna.

## Connections (Continued)

### Display Formats Overview

- The HDTV Tuner offers various display formats and multiple video outputs. When the HDTV Tuner is connected to A/V systems, the HDTV Tuner can provide video signal formats 1080i, 720p, 480p, and 480i.
- 1080i, 720p, 480p, and 480i modes are available for component video (YPbPr) outputs.
- 1080i, 720p, and 480p modes are available for RGB and DVI outputs.
- 480i mode is available for VIDEO, S-VIDEO, and COMPONENT VIDEO outputs.
- The HDTV Tuner has two digital audio outputs; Dolby Digital 5.1 and PCM. The HDTV Tuner sends out a digital audio signal to OPTICAL and COAXIAL audio outputs when digital broadcasts are being received by the HDTV Tuner.

### Analog Monitor Connections

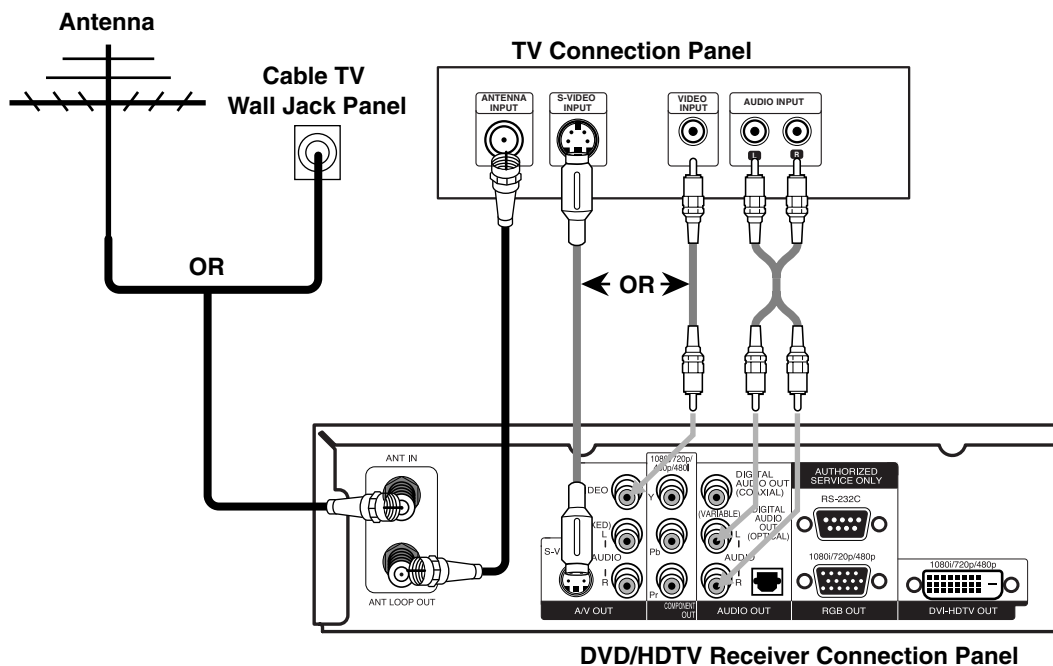

- 1 Connect the "Antenna/Cable" to the "ANT IN" jack on the DVD/HDTV Receiver using a coaxial RF cable.

#### Note

There might be some areas where the signal strength could be too high. If so, you may need to connect the antenna to an optional attenuator. Screw the attenuator onto the "ANT IN" jack. (Refer to page 12.)

- 2 Connect the "ANT LOOP OUT" jack on the DVD/HDTV Receiver to the "Antenna In" jack on your TV using a coaxial RF cable.
- 3 Connect the "AUDIO OUT" and "VIDEO OUT" jacks on the DVD/HDTV Receiver to the "A/V IN" jacks on your TV using RCA-type cables. If your TV is equipped with an S-Video jack, use the S-VIDEO OUT jack.

## Connections (Continued)

### HD Monitor Component (YPbPr) Connections

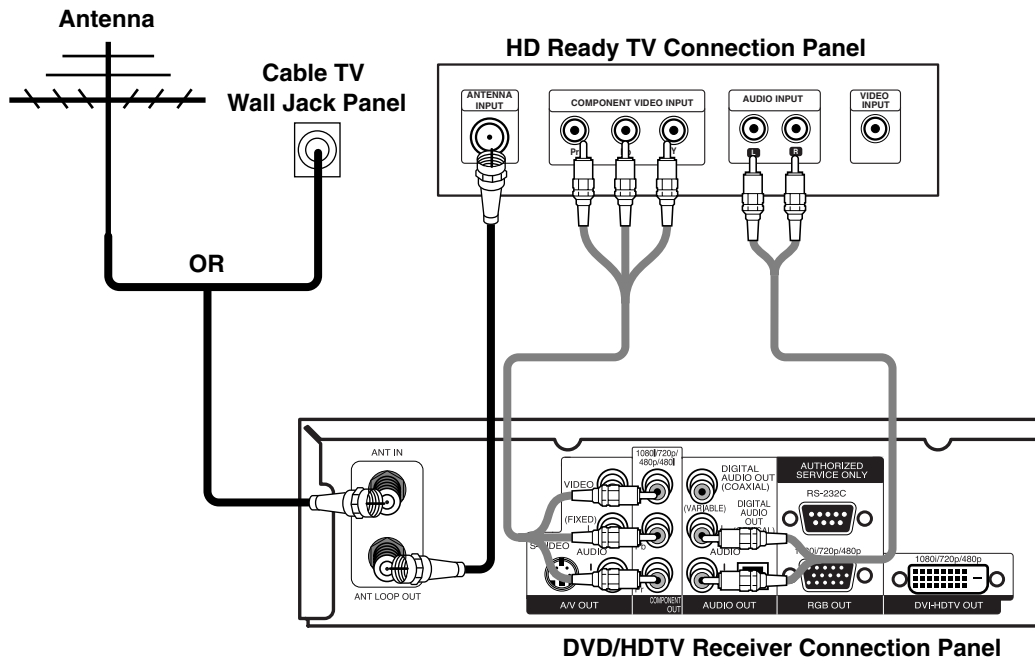

- 1 Connect the "Antenna/Cable" to the "ANT IN" jack on the DVD/HDTV Receiver using a coaxial RF cable.

#### Note

There might be some areas where the signal strength could be too high. If so, you may need to connect the antenna to an optional attenuator. Screw the attenuator onto the "ANT IN" jack. (Refer to page 12.)

- 2 Connect the "ANT LOOP OUT" jack on the DVD/HDTV Receiver to the "Antenna In" jack on your TV using a coaxial RF cable.

- 3 Connect the "COMPONENT OUT" jacks on the DVD/HDTV Receiver to the "COMPONENT IN" jacks of your TV using RCA-type cables. (The Output Selection must be set to YPbPr, refer to Setting the Display Format on page 19)

- 4 Connect the L/R "AUDIO OUT" jacks on the DVD/HDTV Receiver to the L/R "AUDIO IN" jacks on your TV using RCA-type cables.

#### Note

The component out jacks are useable if 1080i, 720p, 480p, 480i, native, variable 1, variable 2, or variable 3 display format is selected.

## Connections (Continued)

### HD Monitor RGB Connections

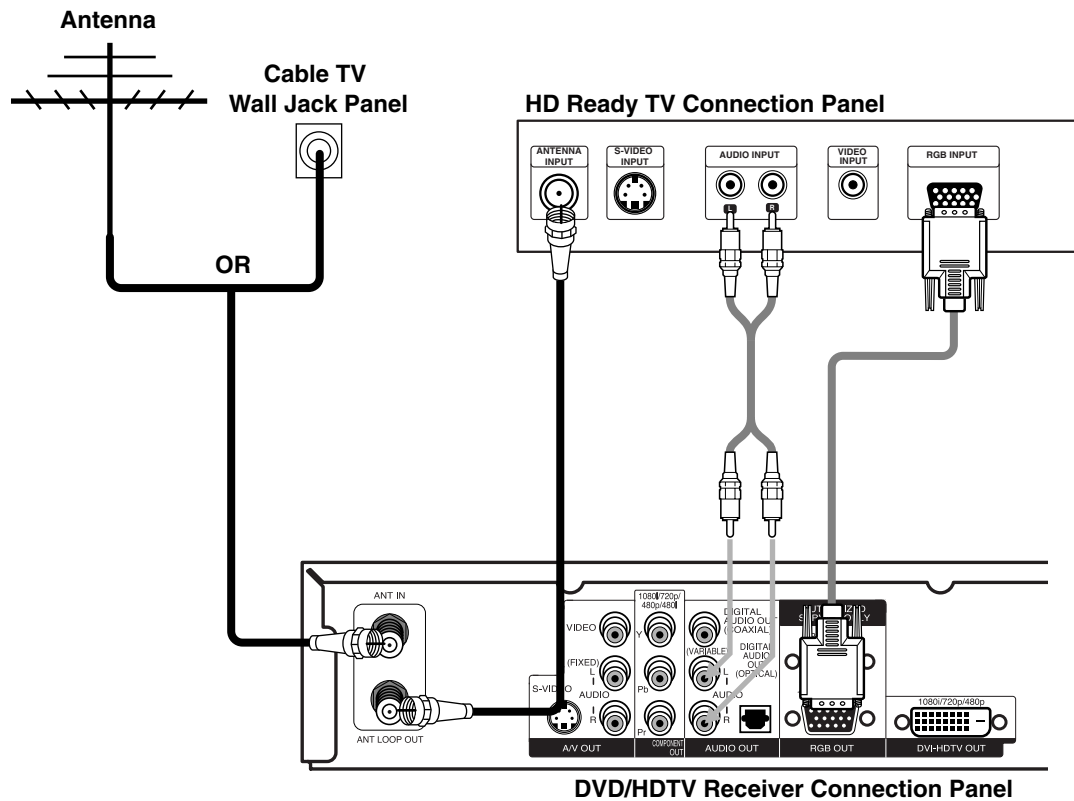

**1** Connect the “Antenna/Cable” to the “ANT IN” jack on the DVD/HDTV Receiver using a coaxial RF cable.

#### **Note**

There might be some areas where the signal strength could be too high. If so, you may need to connect the antenna to an optional attenuator. Screw the attenuator onto the “ANT IN” jack. (Refer to page 12.)

**2** Connect the “ANT LOOP OUT” jack on the DVD/HDTV Receiver to the “Antenna In” jack on your TV using a coaxial RF cable.

**3** Connect the “RGB OUT” jack on the DVD/HDTV Receiver to the “RGB IN” jack of your TV using VGA-type connector. (The Output Selection must be set to RGB, refer to Setting the Display Format on page 19)

**4** Connect the L/R “AUDIO OUT” jacks on the DVD/HDTV Receiver to the L/R “AUDIO IN” jacks on your TV using RCA-type cables.

#### **Note**

The **RGB output** is useable if 1080i, 720p, 480p, native, variable 1, variable 2, or variable 3 display format is selected.



## Connections (Continued)

### HD Monitor DVI-HDTV Connections

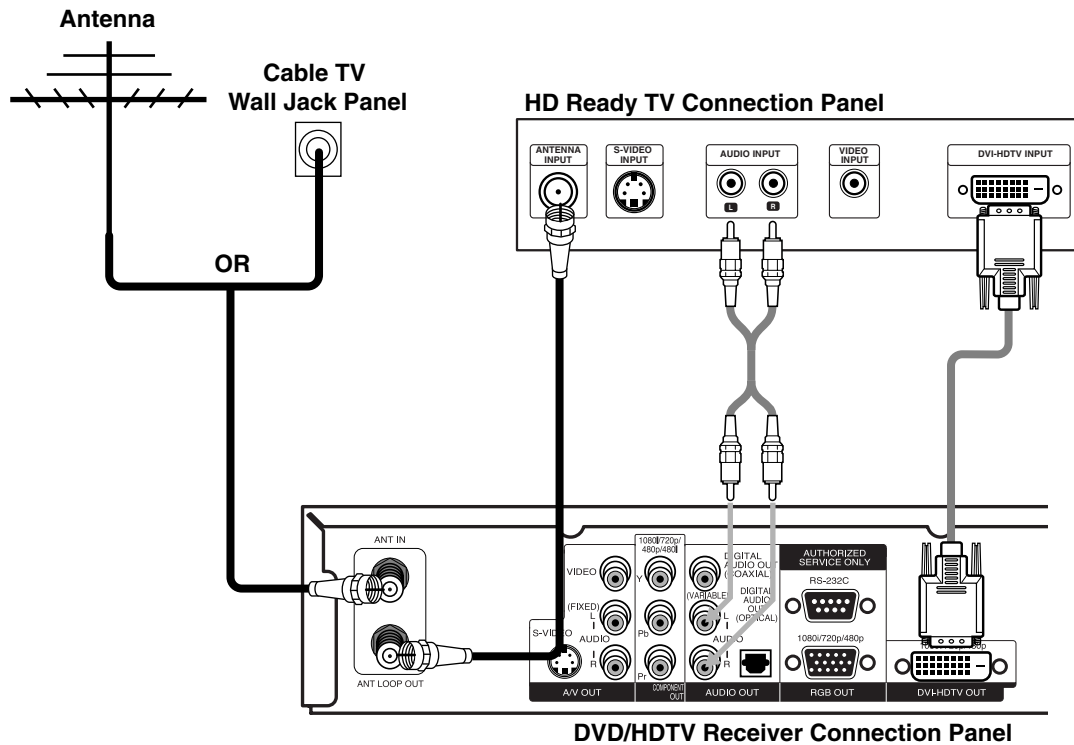

**1** Connect the "Antenna/Cable" to the "ANT IN" jack on the DVD/HDTV Receiver using a coaxial RF cable.

#### Note

There might be some areas where the signal strength could be too high. If so, you may need to connect the antenna to an optional attenuator. Screw the attenuator onto the "ANT IN" jack. (Refer to page 12.)

**2** Connect the "ANT LOOP OUT" jack on the DVD/HDTV Receiver to the "Antenna In" jack on your TV using a coaxial RF cable.

**3** Connect the "DVI-HDTV OUT" jack on the DVD/HDTV Receiver to the "DVI IN" jack of your TV using DVI-type connector. (The Output Selection must be set to DVI, refer to Setting the Display Format on page 19)

**4** Connect the L/R "AUDIO OUT" jacks on the DVD/HDTV Receiver to the L/R "AUDIO IN" jacks on your TV using RCA-type cables.

#### Note

- DVI-HDTV OUT is useable if 1080i, 720p, or 480p display format is selected.
- A DVI-HDTV input is one that is compliant with EIA-861 and HDCP specifications. Check your TV or monitor's user manual to find out if the TV or monitor's DVI input is compliant with these specifications.
- Some HD Monitors designed for PC applications using DVI-D may not work with this connection.

## Connections (Continued)

### VCR Connections

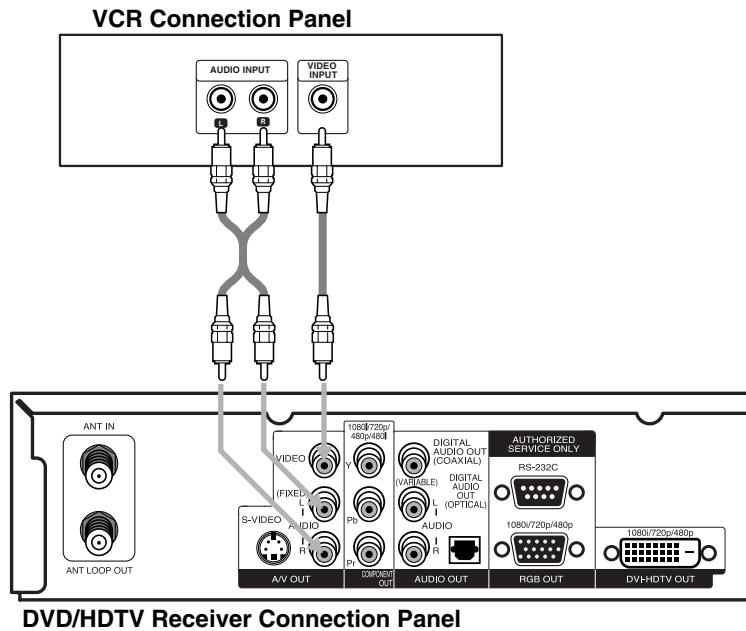

Connect the L/R "AUDIO OUT" jacks and "VIDEO OUT" jack on the DVD/HDTV Receiver to the "A/V in" jacks on your VCR using RCA-type cables. (If your VCR is equipped with an S-Video jack, use the "S-Video" jack.)

#### Caution

**If 480i display format is selected, the VCR will record an onscreen display onto the tape during recording if:**  
the channel is changed with CH (+/-)  
the sound level is adjusted with VOL (+/-)  
or by pressing the SELECT button, etc.

## Connections (Continued)

### Amplifier (Receiver) Connections

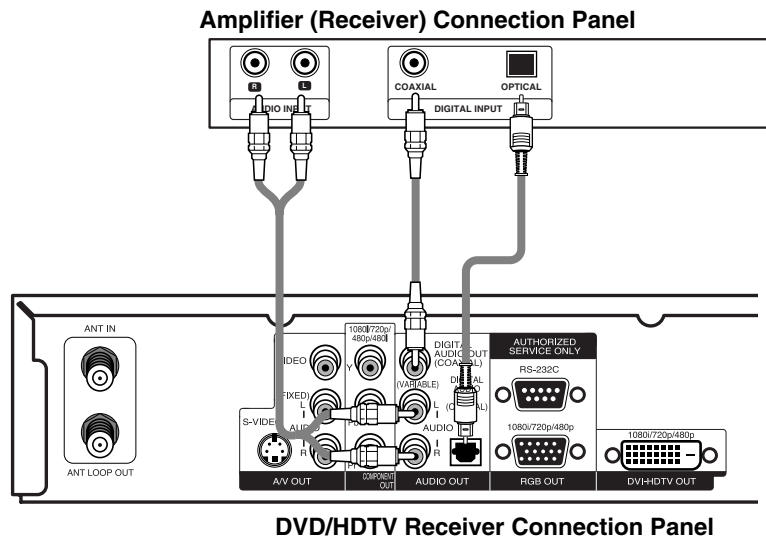

#### Connecting to an amplifier equipped with two channel analog stereo or Dolby Surround

Connect the Left and Right AUDIO OUT jacks on the DVD/HDTV Receiver to the audio left and right in jacks on your amplifier, receiver, or stereo system, using the supplied audio cables.

#### Connecting to an amplifier equipped with two channel digital stereo (PCM) or to an Audio/ Video receiver equipped with a multi-channel decoder (Dolby Digital™)

Connect one of the DVD/HDTV Receiver's DIGITAL AUDIO OUT jacks (OPTICAL or COAXIAL) to the corresponding input jack on your amplifier. Use an optional digital (optical or coaxial) audio cable.

#### Digital Multi-channel sound

A digital multi-channel connection provides the best sound quality. For this you need a multi-channel Audio/Video receiver that supports one or more of the audio formats supported by your DVD/HDTV Receiver (Dolby Digital). Check the receiver manual and the logos on the front of the receiver.

## Setting the Display Format

The DVD/HDTV Receiver provides several display formats. The DISPLAY FORMAT button on the front panel changes the output connector and resolution. The output resolution may be converted from the original broadcast format.

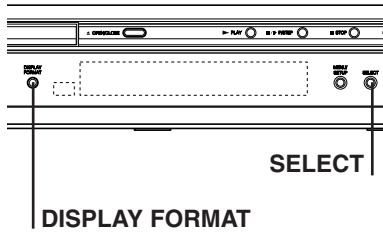

### Display Format Setup.

- 1** Press **DISPLAY FORMAT** once on the front panel.  
The current output signal appears in the display window.
- 2** Depending on the type of monitor that the DVD/HDTV Receiver is connected to, press **DISPLAY FORMAT** or **◀/▶** repeatedly on the front panel to select desired output connector. (YPbPr, RGB, or DVI)
- 3** Press **SELECT** on the front panel to confirm your selection of the output connector.  
The current output resolution appears in the display window.
- 4** Depending on the type of monitor that the DVD/HDTV Receiver is connected to, press **DISPLAY FORMAT** or **◀/▶** repeatedly on the front panel to select desired output resolution. (1080i, 720p, 480p, 480i, native, variable 1, variable 2, or variable 3)
- 5** Press **SELECT** on the front panel to confirm your selection of the output resolution.  
Display Format setup is complete.

#### Note

- To exit Display Format Setup mode, press EXIT on the remote control.
- Some Monitors may not work with some output resolutions.

Display Format Modes	Input Signal Formats	Output Signal Formats
1080i	all formats	1080i
720p	all formats	720p
480p	all formats	480p
480i	all formats	480i
native	1080i	1080i
	720p	720p
	480p	480p
	480i	480i (YPbPr), 480p (RGB, DVI)
variable 1	1080i	1080i
	720p	720p
	480p/480i	480p
variable 2	1080i/720p	1080i
	480p/480i	480p
variable 3	1080i/720p	720p
	480p/480i	480p

OUTPUT CONNECTION	AVAILABLE FORMATS
COMPONENT VIDEO OUT	1080i/720p/480p/480i/native/variable 1/variable 2/variable 3
RGB OUT	1080i/720p/480p/native/variable 1/variable 2/variable 3
DVI-HDTV OUT	1080i/720p/480p/native/variable 1/variable 2/variable 3
VIDEO OUT	All formats converted to 480i
S-VIDEO OUT	All formats converted to 480i

## Pre-operation Setup

In this menu system, there are several ways to customize the settings provided. Most menus consist of three levels to set up the options, but some require greater depth for the variety of settings. If you press the MENU button, only the first and second level of the menu system will appear on the TV screen. The third level can be displayed by pressing **⊙** (SELECT). If a menu has more than three levels, the pop-up dialogue box will be displayed as the fourth or fifth level. For navigating the menu levels, you will see “▶” on the right side of the menu label to help you go to the next level.

### To show and remove the Menu:

Press the MENU button on the remote control to display the menu. A second press of the MENU button or a press of the EXIT button will take you back to TV viewing.

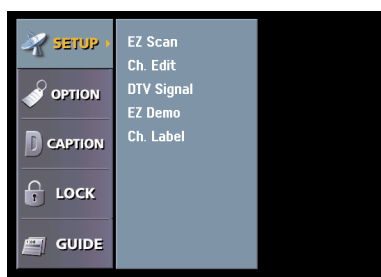

### To go to the next level:

Press “**⊙**” (or “▶”) on the remote control.

### To go back to the previous level:

Press MENU (or “◀”) on the remote control.

## General Operation

- 1 Press MENU.**  
The main menu appears.
- 2 Use ▲ / ▼ to select the desired menu option.**
- 3 While the desired menu option is selected, press ▶ or ⊙ (SELECT) to move to the second level.**
- 4 Use ▲ / ▼ to select the second menu option.**
- 5 Press ▶ or ⊙ (SELECT) to move to the third level.**  
Some menu options require additional steps.
- 6 Press MENU to exit the Setup menu.**

## Setup Menu Options

### EZ Scan (Channel Search)

Automatically finds all channels (digital) available using the 'Ant In' source, and stores all the active channels found on the channel list. Inactive or weak channels may not appear on the list. In that case, add missing channels manually with the Ch. edit menu. The channel list created here can be seen in the Ch. Edit menu.

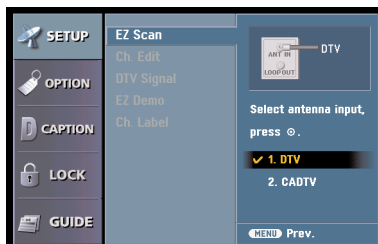
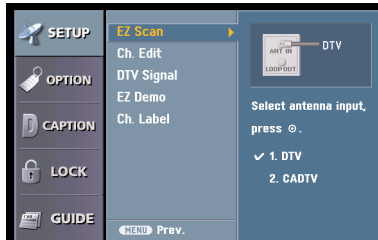

**1** Press MENU to display the on-screen menu.

**2** Select the SETUP menu using ▲ / ▼ then press Ⓞ (SELECT) or ► to move to the second level.

**3** Select EZ Scan using ▲ / ▼ then press Ⓞ (SELECT).

**4** Select the signal source (DTV or CADTV).  
DTV is for over-the-air antenna reception.  
CADTV is for cable subscribers.

#### **N**otes

- If you select CADTV, select a cable band (STD, HRC, or IRC). Ask your cable service provider about cable band.
- In most cases you can search channels correctly by selecting STD cable band. Try the other bands if you cannot find any channels.
- Some scrambled channels may not be stored.

**5** Press Ⓞ (SELECT).

The channel search process begins. You can stop the process by pressing Ⓞ (SELECT) or MENU.

**6** When channel search is complete, the lowest channel number found appears on the TV screen.

## Setup Menu Options (Continued)

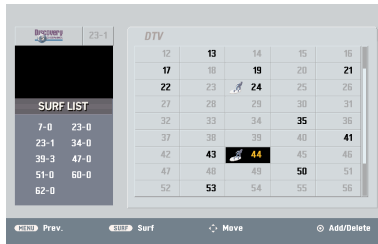
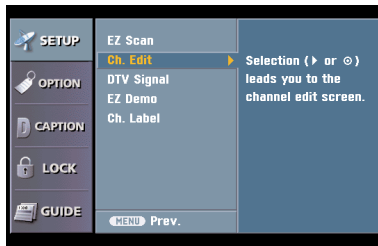

### Ch. Edit (Channel Edit)

This feature allows you to add or erase channels from memory manually and create your own surf list, with up to 10 favorite channels. Press SURF on the remote control when a channel is highlighted.

- 1 Press MENU to display the on-screen menu.
- 2 Select the SETUP menu using ▲ / ▼ then press ◉ (SELECT) or ▶. Ch. Edit will be highlighted.
- 3 Select Ch. Edit using ▲ / ▼ then press ◉ (SELECT) or ▶. Channel Edit menu appears.

#### To create a custom list:

1. Select a channel to add or erase using ▲ / ▼ / ◀ / ▶ on the channel editing menu.
2. Press ◉ (SELECT) repeatedly to add or erase the channel from memory.

#### To create a Surf list:

1. Select a channel using ▲ / ▼ / ◀ / ▶ on the channel editing menu.
2. Press SURF to add the channel to the SURF LIST.

#### Note

- Only channels already on the custom list can be added to the Surf list.

- 4 Press MENU to return to the previous screen or press EXIT on the remote control to return to TV viewing.



### DTV Signal

Shows the strength bar for incoming signal. This information can be used to help you adjust the antenna to the correct position for your location.

- 1 Press MENU to display the on-screen menu.
- 2 Select the SETUP menu using ▲ / ▼ then press ◉ (SELECT) or ▶.
- 3 Select the DTV Signal using ▲ / ▼. The signal strength bar will be displayed.
- 4 Press MENU to return to the previous screen or press EXIT on the remote control to return to TV viewing.

#### Tip

You can also view a channel's strength by pressing SIGNAL on the remote control.



## Setup Menu Options (Continued)

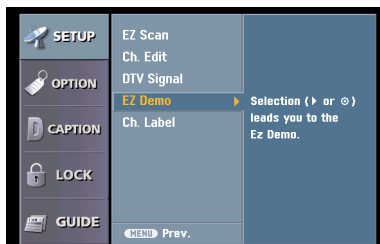

### EZ Demo

Shows you how to navigate through the on-screen menus available on the DVD/HDTV Receiver.

- 1** Press MENU to display the on-screen menu.
- 2** Select the SETUP menu using ▲ / ▼ then press ◉ (SELECT) or ▶ to move to the second level.
- 3** Select EZ Demo using ▲ / ▼ then press ◉ (SELECT) or ▶ to display the menu.
- 4** Press EXIT button on the remote control to return to TV viewing.



### Channel Labels

You are also able to add logos to the channels on the custom channel list using the ◉ (SELECT) button on the remote. Follow the instructions below to add logos to the channels in memory and on the custom channel list.

- 1** Press MENU to display the on-screen menu.
- 2** Select the SETUP menu using ▲ / ▼ then press ◉ (SELECT) or ▶. EZ Scan will be highlighted.
- 3** Select Ch. Label using ▲ / ▼ then press ◉ (SELECT) or ▶. Ch. Label menu appears.
- 4** Select a channel to add a logo to with CH (+/-).
- 5** Select a logo using ▲ / ▼ / ◀ / ▶.
- 6** Press ◉ (SELECT). The logo is added to the channel.
- 7** Repeat steps 4 and 6 to add additional logos.
- 8** Press MENU to return to the previous menu or press EXIT on the remote control to return to TV viewing.

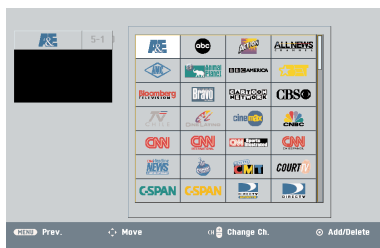

## Option Menu Features

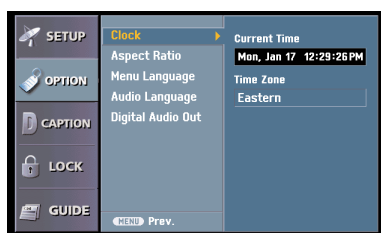

### Clock

Enables the user to adjust the time zone. Normally, your clock is set using signals transmitted by DTV stations. Choosing your time zone sets the current time automatically.

- 1 Press MENU to display the on-screen menu.
- 2 Select the OPTION menu using ▲ / ▼ then press Ⓞ (SELECT) or ►.
- 3 Use ▲ / ▼ to select the Clock option then press ► or Ⓞ (SELECT) to move to the third level.
- 4 Use ◀ / ▶ to set Time Zone: (Atlantic, Eastern, Central, Mountain, Pacific, Alaska, Hawaii, New F.land)
- 5 Press MENU to return to the previous menu or press EXIT on the remote control to return to TV viewing.

#### Note

- There are cases where the TV station does not send, or sends wrong date and/or time information and the DVD/HDTV Receiver sets the incorrect time.
- The clock can not be set by cable DTV band.



### Menu Language

Select a language for the menu.

- 1 Follow Steps 1-2 as above (Clock).
- 2 Select the Menu Language option using ▲ / ▼ then press Ⓞ (SELECT) or ►.
- 3 Select the desired language using ▲ / ▼ then press Ⓞ (SELECT).
- 4 Press MENU to return to the previous menu or press EXIT on the remote control to return to TV viewing.



### Audio Language

Digital channels sometimes provide multiple audio tracks, often in a different language. You can set default audio language with the Audio Language menu.

- 1 Follow Steps 1-2 as above (Clock).
- 2 Select the Audio Language option using ▲ / ▼ then press Ⓞ (SELECT) or ►.
- 3 Select the desired language using ▲ / ▼ then press Ⓞ (SELECT).
- 4 Press MENU to return to the previous menu or press EXIT on the remote control to return to TV viewing.

#### Tip

- If available on the program, you can also select a different audio language while viewing TV by pressing AUDIO repeatedly.
- When multiple audio tracks are available, the audio icon (Ⓞ) appears on the program information display or Program guide. You can select one of the other languages with the AUDIO button.

#### AUDIO button

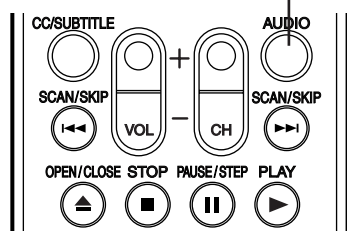

## Option Menu Features (Continued)



Options to view a picture with a wide (16:9) aspect ratio at 480i or 480p mode output format.



Options to view a picture with a normal (4:3) aspect ratio at 720p or 1080i mode output format.

### RATIO button

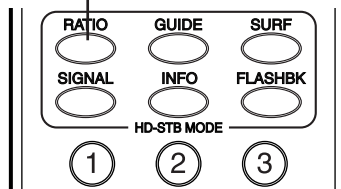

### Cinema Zoom mode

Use to adjust zooming. The picture will be enlarged like the cinema screen up to 16 steps.

## Aspect Ratio

Lets you choose the picture proportion.

- 1** Press **MENU**.  
The main menu appears.
- 2** Use **▲ / ▼** to select the **OPTION** menu then press **▶** or **⊙** (**SELECT**) to move to the second level.
- 3** Use **▲ / ▼** to select the **Aspect Ratio** option.
- 4** Press **▶** or **⊙** (**SELECT**) to move to the third level.
- 5** Use **▲ / ▼** to select an option then press **⊙** (**SELECT**) to confirm your selection.
- 6** Press **MENU** to return to the previous menu or press **EXIT** on the remote control to return to TV viewing.

### Tip

While watching TV, you can change the picture aspect ratio using **RATIO** on the remote control. To view a high definition picture with 480i or 480p format setting, use the **RATIO** button on the remote control to change the wide mode in the following cycle: Letterbox, Cropped, to Squeezed.

To view a standard definition picture with 720p or 1080i format setting, use the **RATIO** button on the remote control to change the wide mode in the following cycle: Normal, Wide, Horizon, Zoom 1, Zoom 2, to Cinema Zoom. (Refer to Aspect Ratio Overview on next page).

## Option Menu Features (Continued)

### Aspect Ratio Overview

#### Modes for viewing high definition content (16:9) when output format is 480i or 480p Mode:

##### Set by program

The aspect ratio will be set to Letter Box.

##### Letter Box

Use for a picture with an original 16:9 aspect ratio (in a wide format). Letterbox mode will shrink the picture to fill the screen, with black/gray (or blank) bars appearing at the top and bottom of the screen.

##### Cropped

Use for a picture filling the entire screen by cropping (removing) the left and right portions of the picture.

##### Squeezed

Use for a full picture filling the entire screen with no black/gray bars. The picture in a 16:9 format will be horizontally adjusted or squeezed to fit the 4:3 ratio monitor. This setting can also be useful when used with 16:9 aspect ratio monitors or with 4:3 aspect ratio monitors that have a "16:9 enhancement" feature.

#### Modes for viewing standard definition content (4:3) when output format is 720p or 1080i Mode:

##### Set by program

The aspect ratio will be set to Normal.

##### Normal

Use for a picture with an original 4:3 aspect ratio on your 16:9 monitor, with black/gray bars appearing at the left and right sides.

##### Wide

Use for a picture adjusted horizontally (in a linear proportion) to fill the entire screen.

##### Horizon

Use to adjust a picture in a non-linear proportion (more at both sides) to create a spectacular view.

##### Zoom 1

The image will be altered vertically (cropped).

##### Zoom 2

More vertically stretch than Zoom 1.

##### Cinema Zoom

Use to adjust zooming. The picture will be enlarged like the cinema screen up to 16 steps.

### Aspect Ratio Summary

Program Format	Output Format	Available Aspect Ratios
16:9	HD(720p/1080i) 16:9	Six Aspect Ratio controls (Set by program, Normal, Wide, Zoom 1, Zoom 2, Cinema Zoom)
16:9	SD(480i/p) 4:3	Set by program, Letter Box, Cropped, Squeezed
4:3	HD(720p/1080i) 16:9	Seven Aspect Ratio controls (Set by program, Normal, Wide, Horizon, Zoom 1, Zoom 2, Cinema Zoom)
4:3	SD(480i/p) 4:3	Set by program, Letter Box, Cropped, Squeezed

## Option Menu Features (Continued)

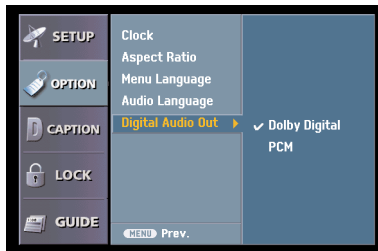

### Digital Audio Output

Sets the DVD/HDTV Receiver's Digital Audio Output according to the type of audio system you use.

- 1** Press **MENU** to display the on-screen menu.
- 2** Select the **OPTION** menu using **▲ / ▼** then press **⊙ (SELECT)** or **▶**.
- 3** Select the **Digital Audio Output** option using **▲ / ▼** then press **⊙ (SELECT)** or **▶**.
- 4** Select the desired digital audio output using **▲ / ▼** then press **⊙ (SELECT)**.

**Dolby Digital:** Select "Dolby Digital" if you connected the DVD/HDTV Receiver's DIGITAL OUT jack to a Dolby Digital decoder (or an amplifier or other equipment with a Dolby Digital decoder).

**PCM:** Select "PCM" when the DVD/HDTV Receiver's DIGITAL OUT jack is connected to a 2-channel digital stereo amplifier.

- 5** Press **MENU** to return to the previous menu or press **EXIT** on the remote control to return to TV viewing.

## Caption Menu Options



### Caption (DTV)

Selects a default Caption language.

The caption language options are English, French, and Spanish. Use the menu to select a language. If the selected language is not available on the current program, the caption for the program is not displayed.

Options are:

Off: DTV Caption is not displayed.

English: English is selected for DTV captions.

French: French is selected for DTV captions.

Spanish: Spanish is selected for DTV captions.

### Notes

- DTV Caption (Standard EIA /CEA 708) will appear only if provided by the broadcaster.
- If DTV and Analog Captions are received simultaneously, you can only select DTV Caption.

### Tip

- If available, you can also select an caption language while viewing TV, press **CC** repeatedly.
- If captions are available, the DTV caption icon (**CC**) appears on the program information display, Program guide, or Station guide to indicate that you can select one of those caption options with the **CC** button. The caption icon will not appear on the program information display or Program guide for analog caption.

## Caption Menu Options (Continued)



### (DTV) Caption Style

Selects DTV Captions appearance menu options.

#### **Style**

Use caption feature defaults as provided by the program or customize captions appearance with the Custom menu options.

Set By Program: Default text provided by a broadcaster is shown when captions appear.

Custom: Customized text is shown when captions appear.

#### **Size (A)**

Selects the font size for captions.

Standard: The standard text size is used for the caption display (15 pixels).

Large: The large text size is used for the caption display (21 pixels).

Small: The small text size is used for the caption display (11 pixels).

#### **Font**

Selects the font type for caption.

#### **Txt. (Text) Color**

Selects the font color for caption.

#### **Txt. (Text) Opacity**

Selects the font opacity for caption.

Solid: The text is solid (without any transparency).

Flash: The text blinks twice a second.

Translucent: The text is translucent.

Transparent: The text is transparent (In this case, whatever the color is, the color does not affect the caption display).

#### **Edge Color**

Selects the edge color for caption (If the edge type is selected as None, the edge color does not have any effect on the caption display).

#### **Edge Type**

Selects the edge type for caption.

None: The text has no edge.

Raised: The text is raised.

Depressed: The text is depressed.

Uniform: The text has a uniform edge.

Left Shadow: The text has a left-shadow edge.

Right Shadow: The text has a right-shadow edge.

#### **Bg. (Background) Color**

Selects the background color for caption.

#### **Bg. (Background) Opacity**

Selects the background opacity for caption.

Solid: The text background color is solid (without any transparency).

Flash: The text background color blinks twice a second.

Translucent: The text background color is translucent.

Transparent: The text background color is transparent (In this case, whatever the background color is, the color does not affect the caption).



## Caption Menu Options (Continued)

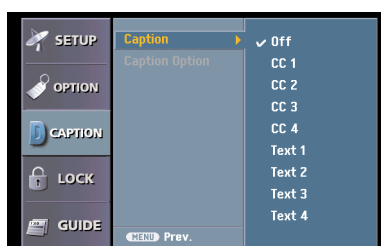

### (Analog) Captions

Selects a mode for displaying Analog Captions. In the Analog Caption Service (if available on program), Captions 1-4 display program's dialog, and Text 1-4 display data service information.

#### **N**ote

- Analog Captions will appear if they are provided by the broadcaster.
- The Caption Option is not available when HD Receiver is receiving analog caption signals only.

#### **Off**

Analog Caption is not displayed.

#### **CC 1**

CC 1 is the primary caption service that synchronizes the captioning language with the sound, used by most broadcasters. Captioning is displayed in the same language as the program's dialog.

#### **CC 2**

CC 2 is the special non-synchronous caption service that does not need to be in sync with the sound and may provide simplified captioning, which is usually delayed.

#### **CC 3**

CC 3 serves as an alternate captioning service channel. Captioning is often a secondary language translation such as French, Spanish, simplified English or displayed at a slower rate.

#### **CC 4**

CC 4 is another special non-synchronous caption service that does not need to be in sync with the sound and may provide simplified captioning, usually delayed.

#### **Text 1 - 4**

Text 1-4 usually displays information on the lower portion of the screen and is used for a data service, generally not program related.

#### **T**ip

If available, press **CC** repeatedly to select a caption language while viewing TV.

#### **N**ote

If DTV and Analog Caption are received simultaneously, you can only select DTV Captions, analog captions will not appear.

## Lock (Parental Control) Menu Options



### Lock System

Allows you to restrict program viewing using blocking schemes. Also allows you to activate or disable all of the lock schemes previously set up. A password is required to gain access to the LOCK menus. When the Lock System is set to Off, the Channel and Program Rating restrictions set are not active.

- 1 Press MENU.**  
The main menu appears.
- 2 Use ▲ / ▼ to select the LOCK then press ► or ● (SELECT) to move to the second level.**

#### When you have not entered a password yet;

Enter "0000" password using the numbered buttons to create a personal 4-digit security password.

#### When you have already entered a password;

Enter a 4-digit password using the numbered buttons to confirm the personal 4-digit security password.

- 3 Use ▲ / ▼ to select the Lock System option.**
- 4 Press ► or ● (SELECT) to move to the third level.**
- 5 Use ▲ / ▼ to select an option (On or Off) then press ● (SELECT) to confirm your selection.**
- 6 Press MENU to return to the previous menu or press EXIT on the remote control to return to TV viewing.**

### Set Password

Changes the password.



- 1 Follow steps 1-2 as shown above (Lock System).**
- 2 Use ▲ / ▼ to select the Set Password option.**
- 3 Press ► or ● (SELECT) to move to the third level.**
- 4 Enter the new 4-digit code.**
- 5 Enter the same code again.**
- 6 Press MENU to return to the previous menu or press EXIT on the remote control to return to TV viewing.**

## Lock (Parental Control) Menu Options (Continued)

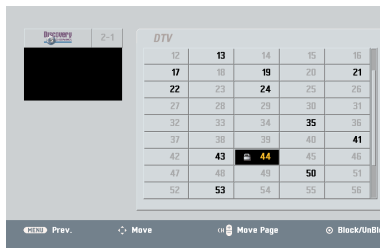
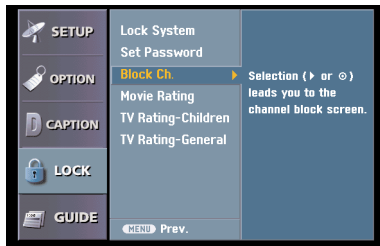

### Block Ch. (Channel)

Blocks any channel that you do not want to view or that you do not want your kids to watch. If you tune in a blocked channel, a black screen with a pop-up box will appear. This menu will override Channel Edit menu settings (page 22).

- 1** Follow Steps 1-2 as shown for the Lock System on page 31.
- 2** Use ▲ / ▼ to select the **Block Ch. (channel)**.  
The channel list screen appears.

#### To move one-by-one:

Use ▲ / ▼ to move by one step on the block channel menu.

#### To move page-by-page:

Use CH+ or CH- button to move to the previous or next page on the block channel menu.

#### To lock or unlock a channel:

Press ● (SELECT) to toggle block or unblock for the channel on the block channel menu.

The 🔒 mark will appear to indicate a the blocked channel.

- 3** Repeat step 2 to block or unblock additional channels in the channel list menu.
- 4** Press MENU to return to the previous menu or press EXIT on the remote control to return to TV viewing.

## Lock (Parental Control) Menu Options (Continued)

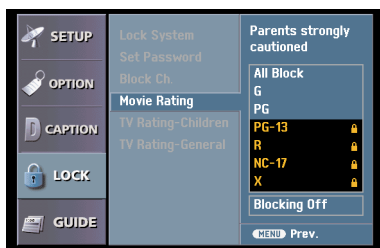

### Movie Rating

Blocks movies according to the movie ratings so children cannot view restricted movies. You can set the ratings to block out all the movies with ratings above a specified level. Keep in mind that the movie ratings apply only to movies shown on TV, not TV programs such as soap operas.

- 1** Follow Steps 1-2 as shown for the Lock System on page 31.
- 2** Use ▲ / ▼ to select the Movie Rating option.
- 3** Press ► or ● (SELECT) to move to the third level.
- 4** Use ▲ / ▼ to select a rating then press ● (SELECT) to confirm your selection.
  - All Block:** All programs with ratings are blocked.
  - G (General Audiences):** Content is not offensive to most viewers.
  - PG (Parental Guidance Suggested):** Content is such that parents may not want their children to view the program.
  - PG-13 (Parental Guidance Suggested):** Program is inappropriate for preteens, with a greater degree of offensive material than a PG rated program.
  - R (Restricted viewing):** Not for children under age 17. Strong elements of sex and/or violence.
  - NC-17 (Restricted Viewing):** Not for children under age 17 under any circumstances. Strong sexual content.
  - X (Hard Core Films):** Same as NC-17 rating.
- 5** Press MENU to return to the previous menu or press EXIT on the remote control to return to TV viewing.

## Lock (Parental Control) Menu Options (Continued)

### TV Rating-Children

Keeps children from watching certain children's TV programs according to the ratings limit set. This rating applies only to TV programs for children. Unless you block TV programs intended for mature audiences in the TV Rating – General menu, your children could view those programs.

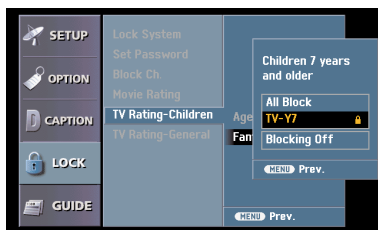
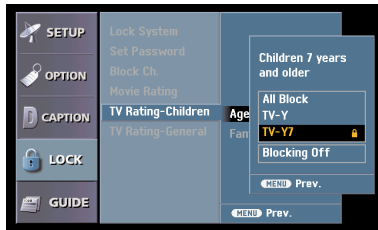

**1** Follow Steps 1-2 as shown for the Lock System on page 31.

**2** Use ▲ / ▼ to select the TV Rating-Children option.

**3** Press ► or ○ (SELECT) to move to the third level.

**4** Use ▲ / ▼ to select: Age, or Fantasy Violence option then press ► or ○ (SELECT).

**Age:** Selection applies regardless of content category of rating.

**Fantasy Violence:** Selection applies if TV programs include rating for Fantasy Violence.

**5** Use ▲ / ▼ to select a rating then press ○ (SELECT) to confirm your selection.

**All Block:** All programs with ratings are blocked.

**TV-Y:** All Children. This program is designed to be appropriate for all children.

**TV-Y7:** Directed to Older Children. This program is designed for children age 7 and above.

**6** Press MENU to return to the previous menu or press EXIT on the remote control to return to TV viewing.

## Lock (Parental Control) Menu Options (Continued)

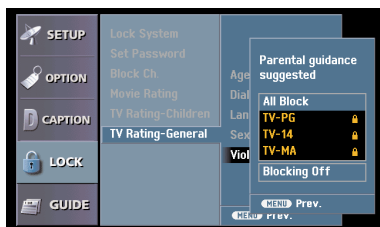
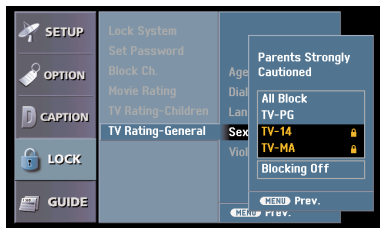
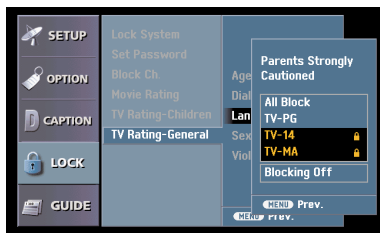
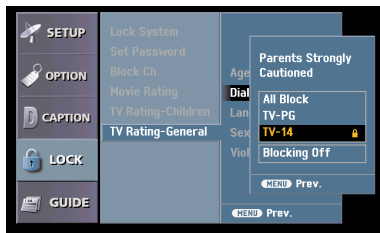
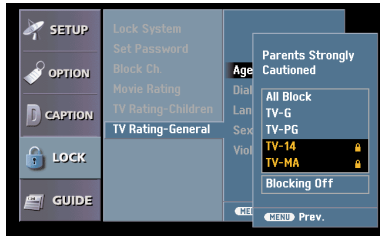

### TV Rating-General

Blocks TV programs that you or your family may not wish to watch, based on the rating scheme set.

**1** Follow Steps 1-2 as shown for the Lock System on page 31.

**2** Use ▲ / ▼ to select the TV Rating-General option.

**3** Press ► or ● (SELECT) to move to the third level.

**4** Use ▲ / ▼ to select the Age, Dialogue, Language, Sex, or Violence then press ► or ● (SELECT).

**Age:** Selection applies regardless of content category of rating.

**Dialogue:** Selection applies if TV programs have rating for Dialogue.

**Language:** Selection applies if TV programs have rating for Language.

**Sex:** Selection applies if TV programs have rating for Sex.

**Violence:** Selection applies if TV programs have rating for Violence.

**5** Use ▲ / ▼ to select a rating then press ● (SELECT) to confirm your selection.

**All Block:** All programs with ratings are blocked.

**TV-G:** General Audience. Most parents would find this program suitable for all ages.

**TV-PG:** Parental Guidance Suggested. This program contains material that parents may find unsuitable for younger children.

**TV-14:** Parents Strongly Cautioned. This program contains some materials that many parents would find unsuitable for children under 14 years of age.

**TV-MA:** Mature Audience Only. This program is specifically designed to be viewed by adults and therefore may be unsuitable for children under 17.

**6** Press MENU to return to the previous menu or press EXIT on the remote control to return to TV viewing.

## GUIDE Menu Options

### Program Guide

The Program Guide contains schedule and program information for all channels. It also provides local over-the-air channels information including conventional digital channels.

Use the Program Guide to find programs easily and conveniently and view schedule and descriptive program information by Time and General classifications.

#### **T**ip

You can also display the Program Guide by pressing **GUIDE** button on the remote control. Refer to Program and Station Guide on pages 39 for more information.

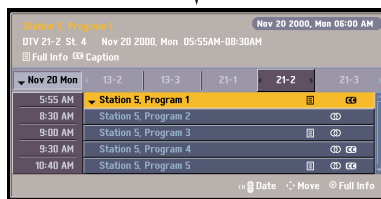
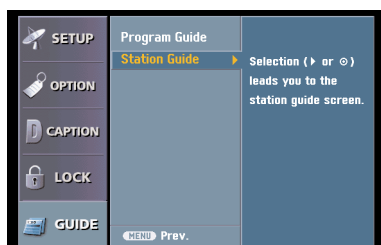
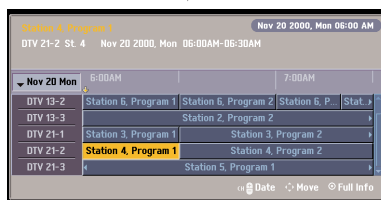
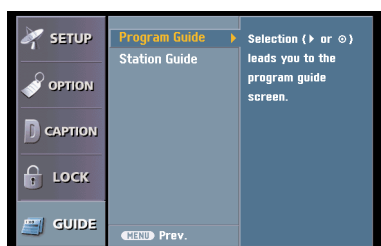

- 1 Press MENU.**  
The main menu appears.
- 2 Use ▲ / ▼ to select the GUIDE menu then press ▶ or ◉ (SELECT) to move to the second level.**
- 3 Use ▲ / ▼ to select the Program Guide option.**
- 4 Press ▶ or ◉ (SELECT) to display the Program Guide.**
- 5 Use ◀ / ▶ / ▲ / ▼ to select a program then press ◉ (SELECT) to get more information for the program.**
- 6 Press EXIT to return to TV viewing.**

### Station Guide

Use the Station Guide to find programs easily and conveniently and view schedule and descriptive program information with channel number.

- 1 Follow Steps 1-2 as shown as above.**
- 2 Use ▲ / ▼ to select the Station Guide option.**
- 3 Press ▶ or ◉ (SELECT) to display the Station Guide.**
- 4 Use ◀ / ▶ / ▲ / ▼ to select a program then press ◉ (SELECT) to get more information for the program.**
- 5 Press EXIT to return to TV viewing.**

#### **N**otes

- The information for program and station guide and time may differ depending on the TV station.
- The informations for program and station guide appears against channel which is already tuned.
- The informations for program and station guide will clear when turns the HDTV Receiver off and on.



## Information Displays

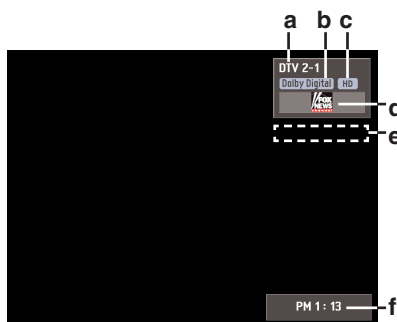

### Channel Banner Display

The Channel Banner appears whenever you tune to a new channel or press the **⊙** (SELECT) button on the remote control while viewing a program.

#### 1 Press **⊙** (SELECT) while watching a program

The Channel Banner appears on the TV screen (Channel number, audio, station name, and current time appear).

- The Channel Banner remains on the TV screen for short time.

- a) Channel Number  
Displays the current channel number.
- b) Dolby Digital  
Indicates audio track is Dolby Digital.
- c) Digital picture definition  
Displays the digital picture grade such as HD (High Definition) or SD (Standard Definition).
- d) Station name  
Displays the station name of the current channel.
- e) Block information  
Displays the block information such as rating blocked, channel blocked, audio only or scrambled.
- f) Time  
Displays the current time.

#### 2 Press **⊙** (SELECT) again while the Channel Banner is displayed.

The Channel Banner disappears from the TV screen.

#### **N**otes

- Station name and clock are displayed only if they are provided on the broadcast.
- On a scrambled channel, the channel banner may not be readable.

## Information Displays (Continued)

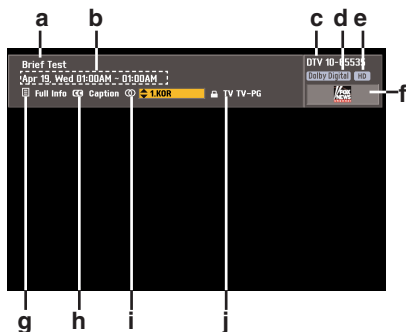

### Program Information Display

Program Information appears whenever you press the INFO button on the remote control while viewing a program.

#### 1 Press INFO while watching a program

Program Information appears on the TV screen.

- a) Program title  
Shows title of current program.
- b) Date, Start Time, and End Time  
Displays the current date, start time and ending time for the current program.
- c) Channel Number  
Shows the current channel number.
- d) Dolby Digital  
Indicates audio track is Dolby Digital.
- e) Digital Picture Definition  
Displays the digital picture grade such as HD (High Definition) or SD (Standard Definition).
- f) Station Name  
Display the station name for the current channel.
- g) Extended Text Message Icon (ⓘ)  
Indicates that there is an Extended Text Message that provides detailed descriptions of the program (see page 39).
- h) DTV Caption Icon (CC)  
Indicates that the current program contains digital closed caption data service.
- i) Multiple Audio icon (⊕)  
Channels sometimes provide multiple audio tracks, often in a different language. When multiple audio tracks are available, the Alternate Audio icon changes its appearance to indicate that you can select one of those other audio tracks with the ▲ / ▼ button.
- j) Content Advisory Icon (Ⓜ)  
Content Advisory data is used for the parental guide control to block programs that are beyond predefined rating criteria set by users. This icon means that the current program contains content advisory data, and displays rating value for the program.

#### 2 To remove the Program Information display, press INFO or EXIT.

The Program Information disappears from the TV screen.

#### Note

Station name and current time are displayed only if they are included on broadcast.

# Program and Station Guides

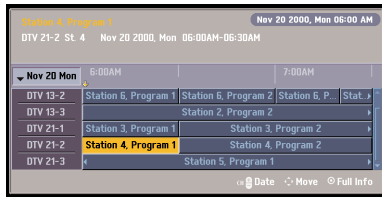

**Program Guide**

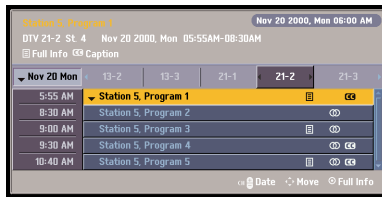

**Station Guide**

**GUIDE button**

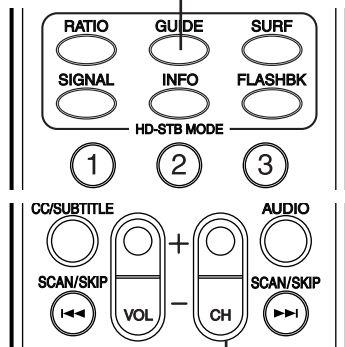

**CH +/- buttons**

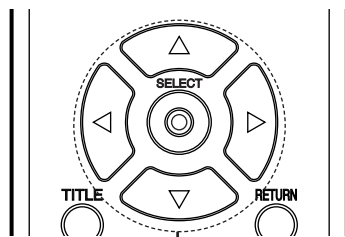

**Arrow buttons**

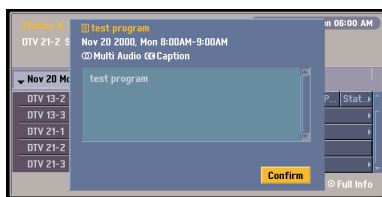

The Program and Station Guides contain schedule and program information for all channels. They also provide local over-the-air channels information including conventional digital channels. Use the Program and Station Guides to find programs easily and conveniently and view schedule and descriptive program information for the channels.

**To Display the Program or Station Guide**

- Press the GUIDE button on your remote control (Program Guide only).
- or
- Press the MENU button on the remote control and select the GUIDE menu. Guide options will appear. Choose the Program or Station Guide option [MENU → GUIDE → Program Guide (or Station Guide)]

**To Exit the Program or Station Guides**

Press the EXIT button to return to the last channel you were tuned to

**Navigating the Program or Station Guides**

The Program and Station Guide are operated based on a simple straightforward “Highlight and Select” process.

1. Use ◀/▶/▲/▼ on your remote control to navigate the guide screen.
2. Press SELECT to select or execute the highlighted menu or function.  
The on-screen guide shows you program listings for five channels within one and half hour time slot. For example: 6:00-7:30. In order to view a list of future programs or other channels, you may continuously press ◀/▶/▲/▼ to scroll horizontally or vertically. This may take a while to reach a specific channel or program, if the channel or program is listed far from the currently highlighted program. The Program and Station Guides thus offers you shortcuts to minimize your effort in navigating channels and time slots.

**Line Scrolling**

You can reach other time slots or channels that are currently hidden from the screen using the arrow buttons “◀/▶/▲/▼”. Move horizontally to reach other channels and move vertically to reach other time slots on the Station Guide.

**Date Scrolling**

When the Program or Station Guide is displayed, you can also change the date of the Program Guide by with the CH +/- buttons.

**To show all Information available on the Extended Text Message**

Pressing the SELECT button will display the full information window for the highlighted program with the Extended Text Message Icon (see page 38). Depending on the broadcaster and service provider, the Extended Text Message may include actor and role relationships, original material, production studio, the date on which the program was first shown, and so on.

**T ips**

- “Confirm” appears on the bottom of the full information window. Press ◉ (SELECT) to remove the full information window.
- You can view additional information on the full information window. Use ▲/▼ to scroll vertically.

## Normal Operation

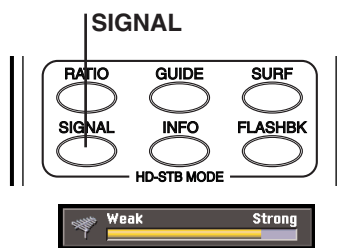
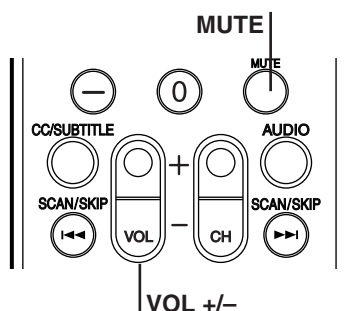
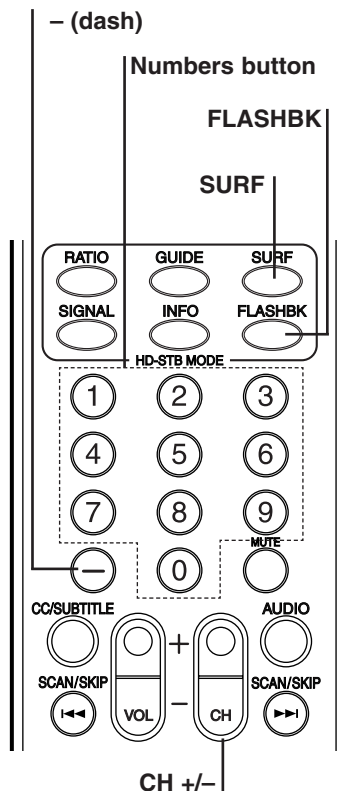

### Channel Selection

See instructions below to select channels.

#### Number and – (dash) buttons (on the remote control)

Use **Number (0-9)** and **– (dash)** buttons to select a channel directly.

#### FLASHBK button (on the remote control)

Press to return to the previous channel you viewed. For example, if the DTV Receiver is tuned to channel 55 and then you change to channel 56, pressing FLASHBK will return to channel 55.

#### SURF button (on the remote control)

Press to scroll through your Surf channels.

#### CH +/- buttons (on the remote control) or ▲ / ▼ (on the front panel)

Use CH +/- on the remote control or ▲ / ▼ on the front panel to cycle the DVD/HDTV Receiver through the channels in memory.

### Volume Adjustment

Adjusts the sound for variable analog audio out on DVD/HDTV Receiver.

#### VOL +/- buttons (on the remote control) or ◀ / ▶ (on the front panel)

Use VOL +/- on the remote control or ◀ / ▶ on the front panel to adjust the volume for analog audio out on the DVD/HDTV Receiver.

#### MUTE (on the remote control)

Press **MUTE** to turn off the sound for analog audio out on the DVD/HDTV Receiver.

#### Notes

- Before setting Audio Variable to Off, make sure that you have turned down the TV's volume to the minimum. Otherwise, sudden high volume sound may cause hearing or speaker damage.
- The volume of Digital Audio out on DVD/HDTV Receiver can not be adjusted on the DVD/HDTV Receiver front panel.

### Signal

Shows the signal strength bar for incoming signal. This can be used to help you adjust the antenna to the correct position from your location. You can view the signal strength bar by pressing SIGNAL on the remote control.

#### Tip

Refer to [www.antennaweb.org](http://www.antennaweb.org) for antenna position.

[AntennaWeb.org](http://www.antennaweb.org), will help you determine the proper outdoor antenna to use in order to receive your local television broadcast channels.

# DVD On-screen Display

## Overview

This manual gives basic instructions for operating the DVD/HDTV Receiver. Some DVDs require specific operation or allow only limited operation during playback. When this occurs, the symbol  appears on the TV screen, indicating that the operation is not permitted by the DVD/HDTV Receiver or is not available on the disc.









## On-Screen Display

Current playback status can be shown on the TV screen. Some options can be changed on the menu.

### On-screen display operation

- 1** Press DISPLAY during playback.
- 2** Use ▲/▼ to select menu option.  
The selected option will be highlighted.
- 3** Use ◀/▶ to change the setting of a menu option.  
The number buttons can be also be used for setting numbers (e.g., title number). For some functions, press ● (SELECT) to execute the setting.







### Playback Status/Restrictions

-  Repeat Title
-  Repeat Chapter
-  Repeat Track (non-PBC Video CDs only)
-  Repeat All Tracks (non-PBC Video CDs only)
-  Repeat A-B
-  Repeat Off
-  Resume play from this point
-  Action prohibited or not available





### Notes

- Some discs may not provide all of the features on the on-screen display example shown below.
- If no button is pressed for 10 seconds, the on-screen display disappears.

#### DVD

Menu Options	Function (Use ▲/▼ to select desired options)	Selection Method
Title Number  1 / 3	Shows the current title number and total number of titles, and skips to the desired title number.	◀ / ▶, or Numbers, ● (SELECT)
Chapter Number  1 / 12	Shows the current chapter number and total number of chapters, and skips to the desired chapter number.	◀ / ▶, or Numbers, ● (SELECT)
Time search  0:20:09	Shows the elapsed playing time, and searches the point by the elapsed time directly.	Numbers, ● (SELECT)
Audio language and Digital Audio Output mode  1 ENG D DD 5.1 CH	Shows the current audio soundtrack language, encoding method, and channel number, and changes the setting.	◀ / ▶, or AUDIO
Subtitle language  OFF	Shows the current subtitles language, and changes the setting.	◀ / ▶, or SUBTITLE
Angle  1 / 1	Shows the current angle number and total number of angles, and changes the angle number.	◀ / ▶, or ANGLE
Sound  NORM.	Shows the current sound mode, and changes the setting.	◀ / ▶

#### VCD2.0 VCD1.1

Menu Options	Function (Use ▲/▼ to select desired options)	Selection Method
Track Number  1 / 3	Shows the current track number, total number of tracks and PBC On mode, and skip to the desired track number.	◀ / ▶, or Numbers, ● (SELECT)
Time  0:20:09	Shows the elapsed playing time (Display only)	-
Audio Channel  STER.	Shows the audio channel, and changes the audio channel.	◀ / ▶, or AUDIO
Sound  NORM.	Shows the current sound mode, and changes the setting.	◀ / ▶

## Before Operation (Continued)

### Pre-operation Setup

You can set your own personal preferences on the DVD/HDTV Receiver's DVD part.

### DVD Player Operation

- 1 Press SETUP.**  
The Setup menu appears.



- 2 Use ▲/▼ to select the desired option.**  
The screen will show the current setting for the selected option, as well as alternate setting(s).
- 3 While the desired option is selected, press ►, then use ▲/▼ to select the desired setting.**
- 4 Press ○ (SELECT) to confirm your selection.**  
Some options require additional steps.
- 5 Press SETUP, RETURN, or PLAY to exit the Setup menu.**

### Language

#### Disc Language **DVD**

Select a language for the disc's Menu, Audio, and Subtitle.

**Original:** The original language set for the disc is selected.  
**Other:** To select another language, use number buttons to enter the corresponding 4-digit number according to the language code list on page 58. If you enter the wrong language code, press CLEAR.



### Menu Language

Select a language for the Setup menu. This is the menu you see when you press SETUP.



### Picture

#### TV Aspect **DVD**

Lets you choose the picture proportion. Refer to Aspect Ratio on page 25-26.

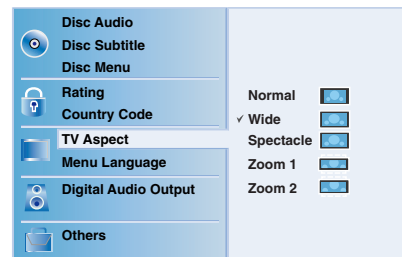

Options to view a picture with a normal (4:3) aspect ratio at 720p or 1080i mode output format.

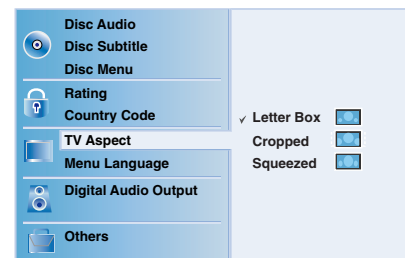

Options to view a picture with a wide (16:9) aspect ratio at 480i or 480p mode output format.

## Before Operation (Continued)

### Sound

#### Digital Audio Output

Each DVD disc has a variety of audio output options. Set the DVD/HDTV Receiver's Digital Audio Output according to the type of audio system you use.

**DOLBY DIGITAL/PCM:** Select "DOLBY DIGITAL/PCM" if you connect the DVD/HDTV Receiver's DIGITAL OUT jack to a Dolby Digital decoder (or an amplifier or other equipment with a Dolby Digital decoder).

**Stream/PCM:** Select "Stream/PCM" if you connect the DVD/HDTV Receiver's DIGITAL OUT jack to an amplifier or other equipment with a DTS decoder, Dolby Digital decoder or MPEG decoder.

**PCM:** Select "PCM" if you connect to a 2-channel digital stereo amplifier. The DVD/HDTV Receiver outputs sound in the PCM 2ch format; when you play a DVD video disc recorded on a Dolby Digital, MPEG1, or MPEG2 recording system.

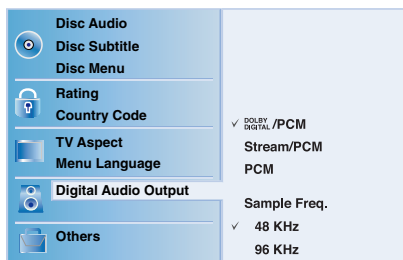

#### Sample Frequency

To change the Sample Frequency setting, first select the desired Digital Audio Output as indicated as above. If your receiver or amplifier is NOT capable of handling 96KHz signals, select 48KHz. When this choice is made, this unit will automatically convert any 96KHz signals to 48KHz so your system can decode them. If your receiver or amplifier is capable of handling 96KHz signals, select 96KHz. When this choice is made, this unit will pass each type of signal through without any further processing.

### Others

#### PBC Setup

- PBC can be turned on or off using (SELECT).

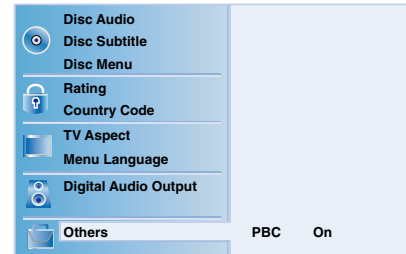

#### PBC

Set Playback Control (PBC) to On or Off.

**On:** Video CDs with PBC are played according to the PBC.

**Off:** Video CDs with PBC are played the same way as Audio CDs.



## Before Operation (Continued)

### Parental Control

#### Rating **DVD**

Movies on DVDs may contain scenes not suitable for children. Therefore, discs may also provide Parental Control information that applies to the complete disc or to certain scenes on the disc. These scenes are rated from 1 to 8, and alternatively, more suitable scenes are available for selection on some discs. Ratings are country-dependent. The Parental Control feature allows you to prevent discs from being played by your children or to have certain discs played with alternate scenes.

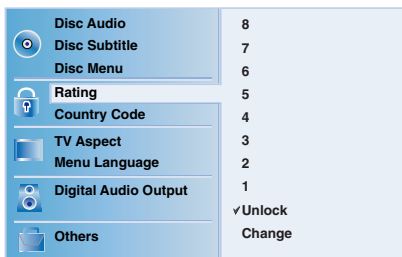

**1** Select "Rating" on the Setup menu using the ▲▼ buttons.

**2** While "Rating" is selected, press ►.

**3** If you have not entered a password yet.

Enter a 4-digit password using the numbered buttons to create a personal 4-digit security password, then press ● (SELECT). Enter the 4-digit password again and press ● (SELECT) to verify.

**If you have entered a password;**

Enter a 4-digit password using the numbered buttons to confirm the personal 4-digit security password, then press ● (SELECT).

If you make a mistake before pressing ● (SELECT), press CLEAR and enter 4-digit security password again.

**4** Select a rating from 1 to 8 using the ▲▼ buttons. One (1) has the least playback restrictions. Eight (8) has the most playback restrictions.

**Unlock:** If you select Unlock, Parental Control is not active. The entire disc will play.

**Ratings 1 to 8:** Some discs contain scenes not suitable for children. If you set a rating for the DVD/HDTV Receiver, all disc scenes with the same rating or lower will be played. Higher rated scenes will not be played unless an alternate scene is available on the disc. The alternate must have the same rating or a lower one. If no suitable alternate is found, playback will stop. You must enter the 4-digit password or change the rating level in order to play the disc.

**5** Press ● (SELECT) to confirm your rating selection, then press SETUP to exit the menu.

#### Country Code **DVD**

Enter the code of a country/area whose standards were used to rate the DVD video disc, referring to the list (See "Country Code List", page 59.).

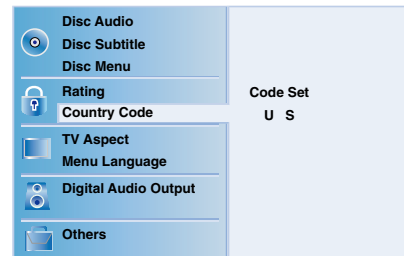

**1** Select Country Code using the ▲▼ buttons on the Setup menu.

**2** While Country Code is selected, press ►.

**3** Follow step 3 of "Rating" on left.

**4** Select the first character using the ▲▼ buttons.

**5** Shift the cursor using ► button and select the second character using ▲▼ buttons.

**6** Press ● (SELECT) to confirm your country code selection, then press SETUP to exit the menu.

#### Note

Confirmation of the 4-digit password is necessary when the code is changed (see "Changing the 4-digit password" below.).

#### Changing the 4-digit password

1. Follow Steps 1-2 as shown above to the left (Rating).
2. Enter the old code, then press ● (SELECT).
3. Select Change using ▲▼ buttons then press ● (SELECT).
4. Enter the new 4-digit code, then press ● (SELECT).
5. Enter exactly the same code a second time and verify by pressing ● (SELECT).
6. Press SETUP to exit the menu.

#### If you forgot your 4-digit password

If you forget your password, to clear the current password, follow the procedure below.

1. Press SETUP to display the Setup menu.
2. Use the Number buttons to enter the 6-digit number "210499".  
The 4-digit password is cleared.
3. Enter a new password as described above to the left (Rating).



## DVD and Video CD Operation

### Playing a DVD or Video CD

#### Playback Setup **DVD** **VCD2.0** **VCD1.1**

- Turn on the TV and select the video input source connected to the DVD/HDTV Receiver.
- Audio system: Turn on the audio system and select the input source connected to the DVD/HDTV Receiver.

**1** Press OPEN/CLOSE to open the disc tray.

**2** Load your chosen disc in the tray, with the playback side down.

**3** Press OPEN/CLOSE to close the tray. READING appears on the TV screen, and playback starts automatically. If playback does not start, press PLAY.

In some cases, the disc menu might appear instead.

#### If a menu screen is displayed

A menu screen may be displayed first after loading a DVD or Video CD with menus.

#### **DVD**

Use the ◀▶▲▼ buttons to select the title/chapter you want to view, then press Ⓒ (SELECT) to start playback. Press TITLE or DISC MENU to return to the menu screen.

#### **VCD2.0**

- Use the number buttons to select the track you want to view.  
Press RETURN to return to the menu screen.
- Menu setting and the exact operating procedures for using the menu may differ depending on the disc. Follow the instructions on the each menu screen. You also may set PBC to Off under setup. See page 43.

#### Notes

- If Parental Control is set and the disc is not within the Rating settings (not authorized), the 4-digit code must be entered and/or the disc must be authorized (see “Parental Control”, on page 44).
- DVDs may have a region code.  
The DVD/HDTV Receiver will not play discs that have a region code different from the DVD/HDTV Receiver. The region code for this DVD/HDTV Receiver is 1 (one).

### General Features

#### Note

Unless stated otherwise, all operations described use the remote control. Some features may also be available on the Setup menu.

#### Changing TITLES **DVD**



If a disc has more than one title, you can move to another title as follows:

- Press DISPLAY in Stop mode, then press the appropriate numbered button (0-9) to select a title number.

#### Changing CHAPTER/TRACKS



If a title on a disc has more than one chapter or a disc has more than one track, you can move to another chapter/track as follows:

- Press SCAN/SKIP ◀◀ or ▶▶ briefly during playback to select the next chapter/track or to return to the beginning of the current chapter/track.
- Press ◀◀ twice briefly to step back to the previous chapter/track.
- To go directly to any chapter during DVD playback, press DISPLAY. Then, use ▲/▼ to select the chapter/track icon. Then, enter the chapter/track number using the numbered buttons (0-9).

#### Note

For two-digit numbers, press the numbered buttons (0-9) in rapid succession.

#### Search **DVD** **VCD2.0** **VCD1.1**

1. Press and hold SCAN/SKIP ◀◀ or ▶▶ for about two seconds during playback.  
The DVD/HDTV Receiver will now go into SEARCH mode.
2. Press and hold SCAN/SKIP ◀◀ or ▶▶ repeatedly to select the required speed: ◀◀X2, ◀◀X4, ◀◀X16, ◀◀X100 (backward) or ▶▶X2, ▶▶X4, ▶▶X16, ▶▶X100 (forward).  
With a Video CD, the Search speed changes: ◀◀X2, ◀◀X4, ◀◀X8, (backward) or ▶▶X2, ▶▶X4, ▶▶X8, (forward).
3. To exit SEARCH mode, press PLAY.

#### Still Picture and Frame-by-Frame Playback



1. Press PAUSE/STEP during playback.  
The DVD/HDTV Receiver will go into PAUSE mode.
2. You can advance the picture frame-by-frame by pressing PAUSE/STEP repeatedly on the remote control.
3. To exit still motion mode, press PLAY.

## DVD and Video CD Operation

### General Features (continued)

#### Slow Motion **DVD** **VCD2.0** **VCD1.1**

1. Press SLOW ◀ or ▶ during playback. The DVD player will enter SLOW mode.
2. Use the SLOW ◀ or ▶ to select the required speed: ◀ 1/16, ◀ 1/8, ◀ 1/4 or ◀ 1/2 (backward), or ▶ 1/16, ▶ 1/8, ▶ 1/4 or ▶ 1/2 (forward).
3. To exit slow motion mode, press PLAY.

#### **Note**

Slow motion playback in reverse is not available for Video CD.

#### Zoom **DVD** **VCD2.0** **VCD1.1**

The Zoom function allows you to enlarge the video image and to move through the enlarged image.

1. Press ZOOM during playback or still playback to activate the Zoom function. If you press ZOOM repeatedly, the magnification level increases up to six steps.
2. Use the ◀▶▲▼ buttons to move through the zoomed picture.
3. Press CLEAR to resume normal playback or return to the paused image.

#### **Note**

Zoom may not work on some DVDs.

#### XY Multi-Zoom **DVD** **VCD2.0** **VCD1.1**

The Multi-Zoom function allows you to enlarge or reduce the video image.

1. Press and hold ZOOM for about more than 3 seconds during playback or still playback to activate the XY Multi-Zoom function. "SCREEN FIT ON" appears in the display window.
2. Use the ◀▶▲▼ buttons to enlarge or reduce the picture size size in the XY multi-zoom mode.
3. Press CLEAR or ZOOM to resume normal playback or return to the paused image.

#### **Note**

- Zoom may not work on some DVDs.
- The XY Multi-Zoom function may not work during Zoom mode.

#### Repeat **DVD** **VCD2.0** **VCD1.1**

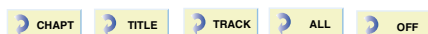

##### DVD Video Discs - Repeat Chapter/Title/Off

1. To repeat the currently playing chapter, press REPEAT. The Repeat Chapter icon appears on the TV screen.
2. To repeat the title currently playing, press REPEAT a second time.

46

The Repeat Title icon appears on the TV screen.

3. To exit Repeat mode, press REPEAT a third time. The Repeat Off icon appears on the TV screen.

##### Video CDs - Repeat Track/All/Off

1. To repeat the track currently playing, press REPEAT. The Repeat Track icon appears on the TV screen.
2. To repeat the disc currently playing, press REPEAT a second time. The Repeat All icon appears on the TV screen.
3. To exit Repeat mode, press REPEAT a third time. The Repeat Off icon appears on the TV screen.

#### **Note**

On a Video CD with PBC, you must set PBC to Off on the Setup menu to use the Repeat function. See page 43.

#### Repeat A-B **DVD** **VCD2.0** **VCD1.1**



To repeat a sequence in a title:

1. Press A-B at your chosen start point. "A \*" appears briefly on the TV screen.
2. Press A-B again at your chosen end point. "A B" appears briefly on the TV screen, and the repeat sequence begins ("A↔B" appears the display window).
3. To cancel the sequence, press A-B.

#### Random **Karaoke DVD** **VCD2.0** **VCD1.1**

1. Press RANDOM during playback or in Stop mode. The unit automatically begins Random Playback and "RANDOM" appears on the display window.
2. To return to normal playback, press RANDOM repeatedly until "RANDOM" disappears from the display window.

#### **Tip**

By pressing SCAN/SKIP ▶▶ during Random playback, the unit selects another title (track) and resumes Random playback.

#### **Note**

- This function only works with DVD Karaoke discs and Video CDs without PBC.
- On a Video CD with PBC, you must set PBC to Off on the Setup menu to use the Random function. See page 43.

#### Changing the Audio Channel



Press AUDIO repeatedly during playback to hear a different audio channel (STER., LEFT or RIGHT).

## DVD and Video CD Operation (Continued)

### General Features (continued)

#### 3D Surround

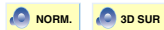

This DVD/HDTV Receiver can produce 3D Surround effects, which simulate multi-channel audio playback from two conventional stereo speakers, instead of the five or more speakers normally required to listen to multi-channel audio from a home theater system.

1. Press DISPLAY during playback.
2. Use ◀ or ▶ to select the sound option.  
The sound option will be highlighted.
3. Use ▲ or ▼ to select "3D SUR".  
To turn off the 3D Surround effect, select "NORM".

#### Time Search

The Time Search function allows you to start playing at any chosen time on the disc.

1. Press DISPLAY during playback. The on-screen display appears on the screen.  
The Time Search box shows the elapsed playing time of the current disc.
2. Within 10 seconds, use ▲/▼ to select the Time Search icon on the on-screen display.  
The ":-:--:" appears in the Time Search box.
3. Within 10 seconds, use the number buttons to enter the required start time. Enter hours, minutes, and seconds from left to right in the box.  
If you enter the wrong numbers, press CLEAR to remove the numbers you entered. Then enter the correct numbers.
4. Within 10 seconds, press Ⓞ (SELECT) to confirm the start time.  
Playback starts from the selected time on the disc. If you enter an invalid time, playback will continue from the current point.

#### Marker Search



You can start playback from a memorized point. Up to nine Marker points can be memorized.

To enter a marker point, follow these steps.

1. During disc playback, press MARKER when playback reaches the spot that you want to memorize.  
The Marker icon will appear on the TV screen briefly.
2. Repeat step 1 to enter up to nine Marker points on a disc.

#### To Recall a Marked Scene

1. During disc playback, press SEARCH.  
The MARKER SEARCH menu will appear on the screen.
2. Within 10 seconds, use ◀▶ to select a Marker number that you want to recall.
3. Press Ⓞ (SELECT).  
Playback will start from the Marked scene.
4. To remove the MARKER SEARCH menu, press SEARCH.

#### To Clear a Marked Scene

1. During disc playback, press SEARCH.  
The MARKER SEARCH menu will appear on the screen.
2. Use ◀▶ to select the Marker number that you want to erase.
3. Press CLEAR.  
The Marker number will be erased from the list.
4. Repeat steps 2 and 3 to erase additional Marker numbers.
5. To remove the MARKER SEARCH menu, press SEARCH.

### Special DVD Features

#### Checking the contents of DVD Video Discs: Menus

DVDs may offer menus that allow you to access special features. To use the disc menu, press DISC MENU. Then, use the appropriate number button to select an option. Or, use the ◀▶▲▼ buttons to highlight your selection, then press Ⓞ (SELECT).

#### Title Menu

1. Press TITLE.  
If the current title has a menu, the menu will appear on the screen. Otherwise, a disc menu may appear.
2. The menu can list camera angles, spoken language, subtitle options, and chapters for the title.
3. To remove the title menu, press TITLE again.

#### Disc Menu

1. Press DISC MENU.  
The disc menu is displayed.
2. To remove the disc menu, press DISC MENU again.

#### Camera Angle

If the disc contains scenes recorded at different camera angles, you can change to a different camera angle during playback.

- Press ANGLE repeatedly during playback to select a desired angle.  
The number of the current angle appears on the display.

#### Changing the Audio Language

Press AUDIO repeatedly during playback to hear a different audio language or audio track.

#### Subtitles

Press SUBTITLE repeatedly during playback to see any other subtitles available.

#### Note

If Ⓞ appears, the feature is not available on the disc.

## Audio CD and MP3/WMA Disc Operation

### Playing an Audio CD or

### MP3/WMA Disc **CD** **MP3** **WMA**

The DVD/HDTV Receiver can play audio CDs. Also, the DVD/HDTV Receiver can play MP3/WMA formatted recordings on CD-ROM, CD-R, or CD-RW discs.

#### 1 Insert a disc and close the tray.

**Audio CD;** Audio CD menu appears on the TV screen go to step 3.

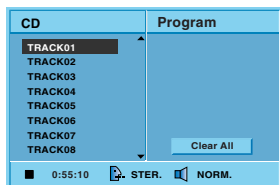

Audio CD Menu

**MP3 or WMA disc;** The MP3-JPEG-WMA choice menu appears on the TV screen. Go to step 2



#### 2 Use ▲/▼ to select MP3 or WMA then press **SELECT**.

The MP3/WMA menu appears on the TV screen. Press RETURN to move to the MP3/WMA-JPEG choice menu.

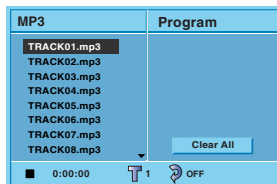

MP3 Menu

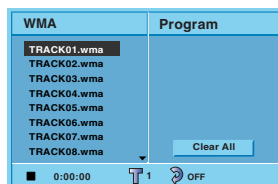

WMA Menu

#### 3 Use ▲/▼ to select a track then press **PLAY** or **SELECT**.

Playback starts.

During playback, the current track's elapsed playing time will appear on the display window and menu.

Playback will stop at the end of the disc.

Press TITLE to move to the next page.

Press DISC MENU to move to the previous page.

#### 4 To stop playback at any other time, press **STOP**.

### Notes on MP3/WMA Recordings

#### About MP3

- A MP3 file is audio data compressed by using the MPEG1 audio layer-3 file-coding scheme. Files that have the ".mp3" file extension are called "MP3 files".
- The DVD/HDTV Receiver can not read a MP3 file that has a file extension other than ".mp3".

#### About WMA (Windows Media Audio)

- A WMA file is Microsoft audio compression technology.
- WMA (Windows Media Audio) offers double the audio compression of the MP3 format.

#### MP3/WMA Disc compatibility with this DVD/HDTV Receiver is limited as follows:

1. Sampling Frequency / only at 44.1kHz (MP3), 32 - 44kbps (WMA)
2. Bit rate / within 32 - 320kbps (MP3), 32 - 128kbps (WMA)
3. CD-R physical format should be "ISO 9660"
4. If you record MP3/WMA files using software which cannot create a FILE SYSTEM, for example "Direct-CD" etc., it is impossible to playback MP3/WMA files. We recommend that you use "Easy-CD Creator", which creates an ISO9660 file system.
5. A single session disc requires MP3/WMA files in the first track. If there is no MP3/WMA file in the 1st track, it cannot playback MP3/WMA files. If you wish to playback MP3/WMA files, format all the data in the disc or use a new one.
6. File names should be named using 8 letters or less and must incorporate ".mp3" or ".wma" extension e.g. "\*\*\*\*\*.mp3" or "\*\*\*\*\*.wma".
7. Do not use special letters such as "/ : \* ? < >" etc.
8. Total number of files on the disc should be less than 200.

This DVD/HDTV Receiver requires discs/recordings to meet certain technical standards in order to achieve optimal playback quality. Pre-recorded DVDs are automatically set to these standards. There are many different types of recordable disc formats (including CD-R containing MP3 or WMA files). That require certain pre-existing conditions (see above) to insure compatible playback.

**Customers should also note that permission is required in order to download MP3/WMA files and music from the Internet. Our company has no right to grant such permission. Permission should always be sought from the copyright owner.**

## Audio CD and MP3/WMA Disc Operation (Continued)

### General Features

#### Pause **CD** **MP3** **WMA**

1. Press PAUSE/STEP during playback.
2. To return to playback, press PLAY or press PAUSE/STEP again.

#### Changing Tracks **CD** **MP3** **WMA**

- Press SCAN/SKIP **⏮** or **⏭** briefly during playback to go to the next track or to return to the beginning of the current track.
- Press SCAN/SKIP **⏮** twice briefly to step back to the previous track.
- Listening an audio CD, to go directly to any track, enter the track number using the numbered buttons (0-9) during playback.

#### Repeat Track/All/Off **CD** **MP3** **WMA**

1. To repeat the track currently playing, press REPEAT. The Repeat icon and "TRACK" appears on the menu screen.
2. To repeat all tracks on a disc, press REPEAT a second time. The Repeat icon and "ALL" appears on the menu screen.
3. To cancel Repeat mode, press REPEAT a third time. The Repeat icon and "OFF" appear on the menu screen.

#### Search **CD**

1. Press and hold SCAN/SKIP **⏮** or **⏭** for about two seconds during playback. The DVD/HDTV Receiver will now go into SEARCH mode.
2. Press and hold SCAN/SKIP **⏮** or **⏭** repeatedly to select the required speed: **⏮X2**, **⏮X4**, **⏮X8** (backward) or **⏭X2**, **⏭X4**, **⏭X8** (forward). Search speed and direction are indicated on the menu screen.
3. To exit SEARCH mode, press PLAY.

#### Random **CD**

1. Press RANDOM during playback or in Stop mode. The unit automatically begins Random Playback and RANDOM or "RAND." appears on the display window and menu screen.
2. To return to normal playback, press RANDOM repeatedly until RANDOM or "RAND." disappear from the display window and menu screen.

#### Repeat A-B **CD**

To repeat a sequence.

1. During disc playback, press A-B at your chosen start point. The Repeat icon and "A \* " appear on the menu screen.
2. Press A-B again at your chosen end point. The Repeat icon and "A B" appear on the menu screen, and the sequence begins to play repeatedly.
3. To exit the sequence and return to normal play, press A-B again. The Repeat icon and "OFF" appear on the menu screen.

#### 3D Surround **CD**

This unit can produce a 3D Surround effect, which simulates multi-channel audio playback from two conventional stereo speakers, instead of the five or more speakers normally required to listen to multi-channel audio from a home theater system.

1. Press DISPLAY during playback.
2. Use **◀** or **▶** to select the sound option. The sound option will be highlighted.
3. Use **▲** or **▼** to select "3D SUR". To turn off the 3D Surround effect, select "NORM".

#### Changing the Audio Channel **CD**

Press AUDIO repeatedly during playback to select a different audio channel (STER., LEFT, or RIGHT).



## Operation with JPEG Disc

### Viewing a JPEG Disc **JPEG**

This DVD/HDTV Receiver can play discs with JPEG files and Kodak picture CDs. Before viewing JPEG files, read the notes on JPEG Files on the right.

#### 1 Insert a disc and close the tray.

The MP3/WMA-JPEG choice menu appears on the TV screen.



#### 2 Use ▲/▼ to select the JPEG option then press ● (SELECT).

The JPEG menu appears on the TV screen.

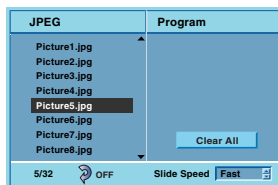

#### 3 If you want to view a particular file, use ▲/▼ to highlight the file and press ● (SELECT) or PLAY.

Viewing the file function starts.

During viewing a file mode, press RETURN to go back to the previous menu (JPEG menu).

Press TITLE to move to the next page.

Press DISC MENU to move to the previous page.

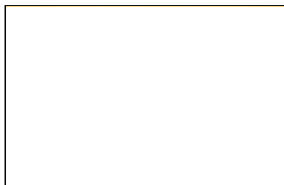

#### **T**ip

There are several viewing Slide Speed options: Fast, Normal, and Slow. Use ◀▶ to highlight the Slide Speed then use ▲/▼ to select the option you want to use, and then press ● (SELECT).

#### 4 To stop viewing at any other time, press STOP. The JPEG menu appears.

### Changing Files

While viewing a picture, press SCAN/SKIP ◀◀ or ▶▶ once to advance to the next file or return to the previous file.

### Repeat All/Off

1. To repeat all files on a disc, press REPEAT when the JPEG menu appears.

The Repeat icon an ALL appears on the menu screen.

2. Press PLAY or ● (SELECT) to start repeat playback.

3. To cancel Repeat mode, first press STOP to stop playback then press REPEAT when the JPEG menu appears.

The Repeat icon an OFF icon appear on the menu screen.

#### **N**ote

The REPEAT button is not available when the **E** mark appears. Press PROGRAM to remove the **E** mark.

### Notes on JPEG Files

- Depending on the size and number of the JPEG files, it could take a long time for the DVD/HDTV Receiver to read the disc's content. If you don't see an on-screen display after several minutes, some of the files are too big — reduce the resolution of the JPEG files to less than 2 mega pixels and burn another disc.
- Total number of files on the disc should be less than 650.
- Some discs may be incompatible due to a different recording format or condition of the disc.
- When you are using software such as "Easy CD Creator" to burn jpeg files on a CD-R, ensure that all the selected files have the ".jpg" extension before copying into the CD layout.
- If the files have ".jpe" or ".jpeg" extensions, please rename them as ".jpg" files.
- File names without ".jpg" extension will not be able to be read by this DVD/HDTV Receiver, even though the files are shown as JPEG image files in Windows Explorer.

## Programmed Playback **CD** **VCD2.0** **VCD1.1** **MP3** **WMA**

### Programmed Playback for Audio CDs, MP3, WMA, and JPEG Files

The Program function can be used to store your favorite tracks from any playable disc in the DVD/HDTV Receiver's memory.

Program can contain 32 tracks (Audio CD) or 60 tracks (MP3/WMA/JPEG disc).

#### 1 Press PROGRAM during playback (Audio CD/MP3/WMA only) or in the Stop mode to enter the Program Edit mode.

The **E** mark will appear to the right of the word Program on the right side of the menu screen.

#### Note

Press PROGRAM to exit the Program Edit mode; the **E** mark will disappear.

#### 2 Select a track, then press **⊙** (SELECT) to place the selected track on the Program list.

#### 3 Repeat step 2 to place additional tracks on the Program list.

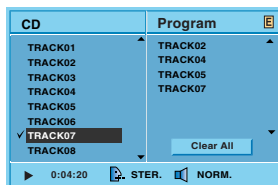

For example: Audio CD Menu

#### 4 Press **▶**.

The programmed track you selected last is highlighted on the program list.

#### 5 Use **▲/▼** to select the track you want to start playing.

Press TITLE to move to the next page.  
Press DISC MENU to move to the previous page.

#### 6 Press PLAY to start.

Playback begins in the order in which you programmed the tracks and the "PROG." appears on the menu screen. Playback stops after playing the last programmed track on the program list.

#### 7 To resume normal playback from programmed playback, select a track on a CD (or MP3/WMA) list and then press **⊙** (SELECT).

"PROG." indicator disappears on the menu screen.

#### To resume normal playback from programmed playback (Audio CD/WMA/MP3 only)

Press and hold PROGRAM for 3 seconds until "PROG." indicator disappears in the display window.

### Video CD Programmed Playback

#### Note

On a Video CD with PBC, you must set PBC to Off on the Setup menu to use the Program function. See page 43.

#### 1 Insert Video CD and close the tray.

#### 2 Press PROGRAM in Stop mode.

The VCD Program menu will appear.

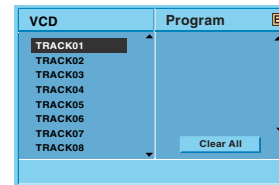

#### Note

Press RETURN or PROGRAM to exit the Program menu.

#### 3 Follow steps 2-6 of "Programmed Playback for Audio CDs, MP3, WMA, and JPEG Files" on left.

#### 4 To resume normal playback from programmed playback, press PROGRAM.

"PROG." indicator disappears from the display window.

### Repeat Programmed Tracks

- To repeat the track currently playing, press REPEAT. The Repeat icon and "TRACK" appears on the menu screen.
- To repeat all tracks on the program list, press REPEAT a second time. The Repeat icon and "ALL" appears on the menu screen.
- To cancel Repeat mode, press REPEAT a third time. The Repeat icon and "OFF" appears on the menu screen.

### Erasing Tracks from the Program List

1. Press PROGRAM during playback (Audio CD or MP3/WMA discs only) or in the Stop mode to enter the Program Edit mode.  
The **E** mark will appear.
2. Press **▶** to move to the Program list.
3. Use **▲/▼** to select the track that you wish to erase from the Program list.
4. Press CLEAR.  
The track will be erased from the Program list.

### Erasing the Complete Program List

1. Follow steps 1-2 of "Erasing a Track from Program List" as above.
2. Use **▲/▼** to select "Clear All", then press **⊙** (SELECT).  
All tracks on the program list will be deleted.  
The programs are also cleared if the disc is removed.

## DVD Additional Information

### Last Condition Memory **DVD**

This DVD/HDTV Receiver memorizes the last condition for the last disc played. Settings remain in memory even if you remove the disc from the DVD/HDTV Receiver or switch it off. If you load a disc that has had its settings memorized, the last stop position is automatically recalled.

#### **N**otes

- Disc settings are stored in memory for use in the future.
- This DVD/HDTV Receiver does not memorize settings for a disc if you turn the DVD/HDTV Receiver off before starting playback.

### Video Mode Setting **DVD** **VCD2.0** **VCD1.1**

- With certain discs, the playback picture may be flickering or Dot Crawl is shown on straight lines. This means Vertical interpolation or De-interlace is not perfectly matched with the disc. In this case, the picture quality may be improved by changing the video mode.
- To change the video mode, press and hold DISPLAY about 3 seconds during disc playback. The new video mode number selected is displayed on the TV screen. Check whether the video quality has improved. If not, repeat the above procedure until picture quality is improved.
- Video mode sequence:  
MODE 1 → MODE 2 → MODE 3 → MODE 4 → MODE 5.
- If you turn off the power, the video mode will return to initial default state (MODE 1).

#### **T**Detailed Description of each Video Mode

**MODE 1:** The source material of the DVD video (film material or video material) is determined from disc information.

**MODE 2:** Suitable for playing video based content with comparatively little motion.

**MODE 3:** Suitable for playing video based content with comparatively more motion.

**MODE 4:** Suitable for playing film based content or video based material recorded by the progressive scan method.

**MODE 5:** Determines the appropriate mode (film or video) during disc playback, and automatically selects the proper mode. Suitable for playing a disc comprised of film and video based content.

### HDCD Playback

HDCD is a process that increases the fidelity of both specially encoded HDCD discs and standard Audio CDs. When an HDCD-encoded disc is playing, the special decoder is automatically activated and the HDCD Indicator lights. No user intervention is required. To enjoy the benefits of HDCD, your DVD/HDTV Receiver must be connected to your A/V receiver via the Analog Audio Outputs. However, if your A/V receiver or surround processor is equipped with built-in HDCD decoding and Digital Audio Output mode is set to stream/PCM on the Setup menu, you may elect to use either the Coaxial or Optical digital audio connections for HDCD playback.



## Programming the Remote Control to Operate Other Devices

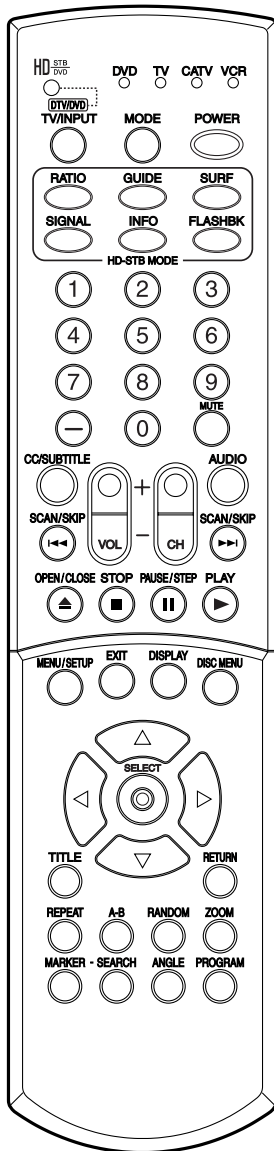

The DVD/HDTV Receiver remote control is a multi-brand or universal remote control that can be programmed to operate most IR remote-controllable devices from other manufacturers.

### Note

The remote control may not be able to control all models of other brands.

#### 1 Test your remote control.

To find out whether your remote control can operate a device without programming, turn on the device such as a VCR. Select the corresponding mode (VCR) with the MODE button on the remote control. While pointing at the device, use the POWER and CH +/- buttons to determine if you can operate the device. If not, the remote control requires programming.

#### 2 Turn on the device to be programmed. Select the corresponding mode (DVD, TV, CATV or VCR) with the MODE button on the remote control.

#### 3 Press the POWER button and the MUTE button simultaneously.

The remote control is now ready to program the code for the device.

#### 4 There are two ways to find the correct code for the device.

**First Method:** If you press the CH + button repeatedly, the codes will change one at-a-time. When the right code is found, the device will turn off.

**Second Method:** Enter the code number using the number buttons on the remote control. The right code numbers for the corresponding device can be found on the following pages. If the code is correct, the device will turn off.

#### 5 Press the EXIT button to store the programming code.

#### 6 Test the remote control functions to see if the device responds properly. If not, repeat from step 2.

## Remote Control Codes for Other Devices

### TV Codes

Brands	Codes
A MARK	112 143
ADMIRAL	072 081 161
AKAI 006	146
AMPRO	073 167
AMSTRAD	052
ANAM	043 054 056 080 104 108 112 115 118 121 131
AOC	004 006 058 112
BLAUPUNKT	088
CANDLE	002 003 004 006
CAPEHART	058
CETRONIC	043
CITIZEN	002 003 004 006 043 101 103 143
CLASSIC	043
CONCERTO	004
CONTEC	039 043 050 051
CORONADO	143
CRAIG	043 054
CROWN	043 143
CURTIS MATHES	004 006 101 116 143
CXC	043
DAEWOO	004 016 017 043 044 055 071 076 103 107 111 114 117 120 123 125 127 128 136 143
DAYTRON	004 116 143
DYNASTY	043
DYNATECH	062
ELECTROHOME	024 077 143
EMERSON	004 005 006 028 043 047 048 050 051 096 116 143 151 153 154 155
FISHER	007 057
FUNAI	028 043
FUTURETECH	043
GE	004 006 008 009 034 056 073 074 091 116 130 144 155 160 161 165
HALL MARK	004 116
HITACHI	004 006 009 010 011 012 023 041 075 143 158 163 166
INFINITY	164
INKEL	129
JBL	164
JCPENNY	004 006 008 009 024 030 065 101 143 156 160
JENSEN	013
JVC	034 038 070 083 145
KEC	043
KENWOOD	006 070
KLOSS	002 059
KMC	143
KTV	006 043 143 154
LG	001 004 102 106 110 112 113 116 119 122 127 137 143
LODGENET	072
LOGIK	072
LUXMAN	004
LXI	007 015 052 081 160 164 166

Brands	Codes
MAGNAVOX	003 004 006 022 059 060 061 063 064 127 143 160 164
MARANTZ	006 077 164
MATSUI	164
MEMOREX	004 007 072 116
METZ	088
MGA	004 006 024 028 042 049 077 116
MINERVA	088
MITSUBISHI	004 006 024 028 040 042 109 116 124 146
MTC	004 006 062 101
NAD	015 025
NEC	006 007 016 019 024 040 056 130 132 134
NIKEI	043
ONKING	043
ONWA	043
OPTONICA	019 081
PADIO SHACK	004
PANASONIC	034 056 080 092 164
PHILCO	003 004 006 024 043 056 059 060 063 064 127 143 164
PHILIPS	003 004 005 006 038 059 070 093 143 160 164
PIONEER	006 018 023 025 027 116 135 176
PORTLAND	004 143
PROSCAN	144 160 161 165 167
PROTON	004 058 116 131 143 171 173
QUASAR	034 056 092
RADIO SHACK	019 043 047 116 127 143
RCA	004 006 023 024 056 065 074 144 152 156 160 161 165
REALISTIC	007 019 043 047
ROCTEC	186
RUNCO	168 169
SAMPO	004 006 058 116
SAMSUNG	004 050 089 101 105 113 116 127 133 137 143 160
SANYO	007 020 021 033 039 053 057 082 166
SCOTT	004 028 043 048 116 143
SEARS	004 007 015 028 030 057 082 094 101 116 143 160
SHARP	004 014 019 022 028 029 081 143 170 175
SIEMENS	088
SIGNATURE	072
SONY	041 070 079 085 126 139 147 185
SOUNDESIGN	003 004 028 043 116
SPECTRICON	112
SSS	004 043
SUPRE MACY	002
SYLVANIA	003 004 006 044 059 060 063 064 116 127 140 160 164
TANDY	081

Brands	Codes
TATUNG	056 062
TECHNICS	034 080 084
TECHWOOD	004
TEKNIKA	002 003 004 006 024 028 031 043 072 077 101 103 143
TELEFUNKEN	037 046 086 087
TELERENT	072
TERA	172
TMK	004 116
TOSHIBA	007 015 030 040 051 062 101 138
TOTEVISION	143
UNIVERSAL	008 009
VIDEO CONCEPTS	146
VIDIKRON	174
VIDTECH	004 116
YAMAHA	004 006
YORK	004 116
YUPITERU	043
ZENITH	072 073 095 103 157
ZONDA	112

### VCR Codes

Brands	Codes
AIWA	034
AKAI	016 043 046 124 125 146
AMPRO	072
ANAM	031 033 103
AUDIO DYNAMICS	012 023 039 043
BROKSONIC	035 037 129
CANON	028 031 033
CAPEHART	108
CRAIG	003 040 135
CURTIS MATHES	031 033 041
DAEWOO	005 007 010 064 065 108 110 111 112 116 117 119
DAYTRON	108
DBX	012 023 039 043
DYNATECH	034 053
ELECTROHOME	059
EMERSON	006 017 025 027 029 031 034 035 036 037 046 101 129 131 138 153
FISHER	003 008 009 010
FUNAI	034
GE	031 033 063 072 107 109 144 147
GO VIDEO	132 136
HARMAN KARDON	012 045
HITACHI	004 018 026 034 043 063 137 150
INSTANTREPLAY	031 033
JCL	031 033
JCPENNY	012 013 015 033 040 066 101
JENSEN	043
JVC	012 031 033 043 048 050 055 060 130 150 152
KENWOOD	014 034 039 043 047 048
LG	001 012 013 020 101 106 114 123

## Remote Control Codes for Other Devices (Continued)

### VCR Codes

Brands	Codes
LLOYD	034
LXI	003 009 013 014 017 034 101 106
MAGIN	040
MAGNAVOX	031 033 034 041 067 068
MARANTZ	012 031 033 067 069
MARTA	101
MATSUI	027 030
MEI	031 033
MEMOREX	003 010 014 031 033 134 139
MGA	045 046 059
MINOLTA	013 020
MITSUBISHI	013 020 045 046 049 051 059 061 151
MTC	034 040
MULTITECH	024 034
NEC	012 023 039 043 048
NORDMENDE	043
OPTONICA	053 054
PANASONIC	066 070 074 083 133 140 145
PENTAX	013 020 031 033 063
PHILCO	031 034 067
PHILIPS	031 033 034 054 067 071 101
PILOT	101
PIONEER	013 021 048
PORTLAND	108
PULSAR	072
QUARTZ	011 014
QUASAR	033 066 075 145
REALISTIC	003 008 010 014 031 033 034 040 053 054 101
RICO	058
RUNCO	148
SALORA	014
SAMSUNG	032 040 102 104 105 107 109 112 113 115 120 122 125
SANSUI	022 043 048 135
SANYO	003 007 010 014 102 134
SCOTT	017 037 112 129 131
<b>Brands</b>	<b>Codes</b>
SEARS	003 008 009 010 013 014 017 020 031 042 073 081 101
SHARP	031 054 149
SHINTOM	024
SONY	003 009 031 052 056 057 058 076 077 078 149
SOUNDESIGN	034
STS	013
SYLVANIA	031 033 034 059 067
SYMPHONIC	034
TANDY	010 034
TATUNG	039 043
TEAC	034 039 043
TECHNICS	031 033 070
TEKNIKA	019 031 033 034 101
THOMAS	034

Brands	Codes
TMK	006
TOSHIBA	008 013 042 047 059 082 112 131
TOTEVISION	040 101
UNITECH	040
VECTOR RESEARCH	012
VICTOR	048
VIDEO CONCEPTS	012 034 046
VIDEOSONIC	040
WARDS	003 013 017 024 031 033 034 040 053 054 131
YAMAHA	012 034 039 043
ZENITH	034 048 056 058 072 080 101

### DVD Codes

Brands	Codes
APEX DIGITAL	022
DENON	020 014
GE	005 006
HARMAN KARDON	027
JVC	012
LG	001 010 016 025
MAGNAVOX	013
MARANTZ	024
MITSUBISHI	002
NAD	023
ONKYO	008 017
PANASONIC	003 009
PHILIPS	013
PIONEER	004 026
PROCEED	021
PROSCAN	005 006
RCA	005 006
SAMSUNG	011 015
SONY	007
THOMPSON	005 006
TOSHIBA	019 008
YAMAHA	009 018
ZENITH	010 016 025

### CATV Codes

Brands	Codes
ABC	003 004 039 042 046 052 053
AJIN	112
ANTRONIK	014
ARCHER	005 007 014 024
CABLE STAR	026
CENTURION	092
CENTURY	007
CITIZEN	007
COLOUR VOICE	065 090
COMBANO	080 081
COMTRONICS	019 030
DIAMOND	023
EAGLE	020 030 040
EASTERN	057 062 066
ELECTRICORD	032
GE	072
GEMINI	008 022 025 054
GI	052 074
GOLDEN CHANNEL	030
HAMLIN	049 050 055
HITACHI	052 055
HOSPITALITY	070 077

Brands	Codes
JERROLD	002 003 004 008 009 010 052 069 074
LG	001 106 101 005
M-NET	037
MACOM	033
MAGNAVOX	010 012 064 079
MEMOREX	100
MOVIE TIME	028 032
NSC	015 028 038 071 073
OAK	016 031 037 053
PANASONIC	044 047
PARAGON	100
PHILIPS	006 012 013 020 065 085 090
PIONEER	034 051 052 063 076
POST NEWS WEEK	016
PRUCER	059
PTS	011 048 071 072 073 074
PULSAR	100
RCA	047
REGAL	049 050
REGENCY	057
REMBRANT	025
RK	091
SAMSUNG	102 107 030 068
SCIENTIFIC ATLANTA	003 011 041 042 043 045 046
SHERITECH	022
SIGNAL	030
SIGNATURE	052
SL MARX	030
SPRUCER	047 078
STARCOM	002 004 008 009
STARGATE	008 030
SYLVANIA	067
TADIRAN	030
TAEKWANG	110
TAIHAN	105
TANDY 017	
TEXSCAN 029 067	
TOCOM 039 040 056	
TOSHIBA 100	
UNIKA 007 014 024	
UNITED CABLE 004 053	
UNIVERSAL 005 007 014 024 026 027 032 035	
VIEWSTAR 012 015 018 086 087 088 089	
ZENITH 100 114 060 093	

## DTV Troubleshooting

Check the following guide for the possible cause of a problem before contacting service.

Symptom	Solution(s)
DVD/HDTV Receiver does not turn on.	<ul style="list-style-type: none"> <li>● Plug the power cord into a wall power outlet securely.</li> </ul>
Fragmented picture and unclear sound.	<ul style="list-style-type: none"> <li>● Check your antenna input, location, and signal strength.</li> </ul>
No picture.	<ul style="list-style-type: none"> <li>● Make sure the correct video display format is selected.</li> <li>● Make sure that the right component type is selected.</li> <li>● If DVD/HDTV Receiver is connected to your monitor or TV via the YPbPr port on the back panel, the output connector setting must be set to the YPbPr position (see page 19). Otherwise, you will probably see an abnormal picture.</li> <li>● If DVD/HDTV Receiver is connected to your monitor or TV via the RGB port on the back panel, the output connector setting must be set to the RGB position. Otherwise, you may not be able to see a picture.</li> <li>● Run EZ Scan and/or use Manual Add if you have not already done so.</li> <li>● Check to make sure all the cables are installed correctly and that the proper source is selected on your TV. For example, Video 1 or 2.</li> <li>● The antenna signal strength may be low. Check the signal strength and adjust the antenna location and direction.</li> <li>● Due to copyright restrictions, you may not be able to view some high definition programs in the high definition format.</li> <li>● Check that the receiver's output resolution is compatible with your monitor or TV.</li> <li>● For more information about connections, please refer to connections on pages 12-18.</li> </ul>
Normal picture but no sound.	<ul style="list-style-type: none"> <li>● Check volume levels.</li> <li>● Make sure the TV is not muted.</li> <li>● Check that the DVD/HDTV Receiver is connected properly.</li> </ul>
Picture is distorted.	<ul style="list-style-type: none"> <li>● Make sure the proper format is selected.</li> <li>● Make sure the proper aspect ratio is selected.</li> <li>● Check that the receiver's output resolution is compatible with your monitor or TV.</li> <li>● Make sure the video output is connected to the TV.</li> </ul>
Available channels are missing.	<ul style="list-style-type: none"> <li>● You can find all the available channels is by running the "EZ Scan" or "EZ Add" in the SETUP menu.</li> </ul>
You forgot your password.	<ul style="list-style-type: none"> <li>● Enter the master password "7777".</li> </ul>
The remote control does not work properly.	<ul style="list-style-type: none"> <li>● Use MODE button to select STB operational mode.</li> <li>● Point the remote control at the remote sensor on the DVD/HDTV Receiver.</li> <li>● Operate the remote control within 23 ft (7 m).</li> <li>● Remove any obstacles in IR signal path to the DVD/HDTV Receiver.</li> <li>● Replace old, exhausted batteries with new ones.</li> </ul>

## DVD Troubleshooting

Check the following troubleshooting chart for the possible cause of a problem before contacting service.

Problem	Possible Cause	Solution
No power.	<ul style="list-style-type: none"> <li>The power cord is disconnected.</li> </ul>	<ul style="list-style-type: none"> <li>Plug the power cord into the wall power outlet securely.</li> </ul>
The power is on, but the DVD/HDTV Receiver does not work.	<ul style="list-style-type: none"> <li>No disc is inserted.</li> </ul>	<ul style="list-style-type: none"> <li>Insert a disc. (Check that the DVD or, audio CD indicator in the display window lights.)</li> </ul>
No picture.	<ul style="list-style-type: none"> <li>The TV is not set to receive DVD signal output.</li> </ul>	<ul style="list-style-type: none"> <li>Select the appropriate video input source on the TV so the picture from the DVD/HDTV Receiver appears on the TV screen.</li> </ul>
	<ul style="list-style-type: none"> <li>The video cable is not connected securely.</li> </ul>	<ul style="list-style-type: none"> <li>Connect the video cable securely.</li> </ul>
	<ul style="list-style-type: none"> <li>The connected TV power is turned off.</li> </ul>	<ul style="list-style-type: none"> <li>Turn on the TV.</li> </ul>
No sound.	<ul style="list-style-type: none"> <li>The equipment connected with the audio cable is not set to receive DVD signal output.</li> </ul>	<ul style="list-style-type: none"> <li>Select the correct input source on the audio receiver so you can listen to the sound from the DVD/HDTV Receiver.</li> </ul>
	<ul style="list-style-type: none"> <li>The audio cables are not connected securely.</li> </ul>	<ul style="list-style-type: none"> <li>Connect the audio cable securely.</li> </ul>
	<ul style="list-style-type: none"> <li>The power of the equipment connected with the audio cable is turned off.</li> </ul>	<ul style="list-style-type: none"> <li>Turn on the equipment connected with the audio cable.</li> </ul>
	<ul style="list-style-type: none"> <li>The Digital Audio Output is set to the wrong position.</li> </ul>	<ul style="list-style-type: none"> <li>Set the Digital Audio Output to the correct position, then turn on the DVD/HDTV Receiver again by pressing POWER.</li> </ul>
The playback picture is poor.	<ul style="list-style-type: none"> <li>The disc is dirty.</li> </ul>	<ul style="list-style-type: none"> <li>Clean the disc.</li> </ul>
The DVD/HDTV Receiver does not start playback.	<ul style="list-style-type: none"> <li>No disc is inserted.</li> </ul>	<ul style="list-style-type: none"> <li>Insert a disc. (Check that the DVD, or audio CD indicator in the DVD display lights.)</li> </ul>
	<ul style="list-style-type: none"> <li>An unplayable disc is inserted.</li> </ul>	<ul style="list-style-type: none"> <li>Insert a playable disc. (Check the disc type, color system, and Regional Code.)</li> </ul>
	<ul style="list-style-type: none"> <li>The disc is placed upside down.</li> </ul>	<ul style="list-style-type: none"> <li>Place the disc with the playback side down.</li> </ul>
	<ul style="list-style-type: none"> <li>The disc is not placed within the guide.</li> </ul>	<ul style="list-style-type: none"> <li>Place the disc on the disc tray correctly inside the guide.</li> </ul>
	<ul style="list-style-type: none"> <li>The disc is dirty.</li> </ul>	<ul style="list-style-type: none"> <li>Clean the disc.</li> </ul>
	<ul style="list-style-type: none"> <li>A Lock Rating level is set.</li> </ul>	<ul style="list-style-type: none"> <li>Cancel the Rating function or change the rating level.</li> </ul>

## Language Code List

Enter the appropriate code number for the initial settings "Disc Audio", "Disc Subtitle" and/or "Disc Menu"  
(See page 42).

Code	Language	Code	Language	Code	Language	Code	Language
6566	Abkhazian	7074	Fiji	7678	Lingala	8373	Singhalese
6565	Afar	7073	Finnish	7684	Lithuanian	8375	Slovak
6570	Afrikaans	7082	French	7775	Macedonian	8376	Slovenian
8381	Albanian	7089	Frisian	7771	Malagasy	8379	Somali
6577	Ameharic	7176	Galician	7783	Malay	6983	Spanish
6582	Arabic	7565	Georgian	7776	Malayalam	8385	Sudanese
7289	Armenian	6869	German	7784	Maltese	8387	Swahili
6583	Assamese	6976	Greek	7773	Maori	8386	Swedish
6588	Aymara	7576	Greenlandic	7782	Marathi	8476	Tagalog
6590	Azerbaijani	7178	Guarani	7779	Moldavian	8471	Tajik
6665	Bashkir	7185	Gujarati	7778	Mongolian	8465	Tamil
6985	Basque	7265	Hausa	7865	Nauru	8484	Tatar
6678	Bengali; Bangla	7387	Hebrew	7869	Nepali	8469	Telugu
6890	Bhutani	7273	Hindi	7879	Norwegian	8472	Thai
6672	Bihari	7285	Hungarian	7982	Oriya	6679	Tibetan
6682	Breton	7383	Icelandic	8065	Panjabi	8473	Tigrinya
6671	Bulgarian	7378	Indonesian	8083	Pashto, Pushto	8479	Tonga
7789	Burmese	7365	Interlingua	7065	Persian	8482	Turkish
6669	Byelorussian	7165	Irish	8076	Polish	8475	Turkmen
7577	Cambodian	7384	Italian	8084	Portuguese	8487	Twi
6765	Catalan	7465	Japanese	8185	Quechua	8575	Ukrainian
9072	Chinese	7487	Javanese	8277	Rhaeto-Romance	8582	Urdu
6779	Corsican	7578	Kannada	8279	Rumanian	8590	Uzbek
7282	Croatian	7583	Kashmiri	8285	Russian	8673	Vietnamese
6783	Czech	7575	Kazakh	8377	Samoan	8679	Volapük
6865	Danish	7589	Kirghiz	8365	Sanskrit	6789	Welsh
7876	Dutch	7579	Korean	7168	Scots Gaelic	8779	Wolof
6978	English	7585	Kurdish	8382	Serbian	8872	Xhosa
6979	Esperanto	7679	Laothian	8372	Serbo-Croatian	7473	Yiddish
6984	Estonian	7665	Latin	8378	Shona	8979	Yoruba
7079	Faroese	7686	Latvian, Lettish	8368	Sindhi	9085	Zulu

## Country Code List

Enter the appropriate code number for the initial setting "Country Code" (See page 44).

Code	Country	Code	Country	Code	Country	Code	Country
AD	Andorra	ER	Eritrea	LC	Saint Lucia	SC	Seychelles
AE	United Arab Emirates	ES	Spain	LI	Liechtenstein	SD	Sudan
AF	Afghanistan	ET	Ethiopia	LK	Sri Lanka	SE	Sweden
AG	Antigua and Barbuda	FI	Finland	LR	Liberia	SG	Singapore
AI	Anguilla	FJ	Fiji	LS	Lesotho	SH	Saint Helena
AL	Albania	FK	Falkland Islands	LT	Lithuania	SI	Slovenia
AM	Armenia	FM	Micronesia	LU	Luxembourg	SJ	Svalbard and Jan Mayen Islands
AN	Netherlands Antilles	FO	Faroe Islands	LV	Latvia	SK	Slovak Republic
AO	Angola	FR	France	LY	Libya	SL	Sierra Leone
AQ	Antarctica	FX	France (European Territory)	MA	Morocco	SM	San Marino
AR	Argentina	GA	Gabon	MC	Monaco	SN	Senegal
AS	American Samoa	GB	Great Britain	MD	Moldavia	SO	Somalia
AT	Austria	GD	Grenada	MG	Madagascar	SR	Suriname
AU	Australia	GE	Georgia	MH	Marshall Islands	ST	Saint Tome and Principe
AW	Aruba	GF	French Guyana	MK	Macedonia	SU	Former USSR
AZ	Azerbaijan	GH	Ghana	ML	Mali	SV	El Salvador
BA	Bosnia-Herzegovina	GI	Gibraltar	MM	Myanmar	SY	Syria
BB	Barbados	GL	Greenland	MN	Mongolia	SZ	Swaziland
BD	Bangladesh	GM	Gambia	MO	Macau	TC	Turks and Caicos Islands
BE	Belgium	GN	Guinea	MP	Northern Mariana Islands	TD	Chad
BF	Burkina Faso	GP	Guadeloupe (French)	MQ	Martinique (French)	TF	French Southern Territories
BG	Bulgaria	GQ	Equatorial Guinea	MR	Mauritania	TG	Togo
BH	Bahrain	GR	Greece	MS	Montserrat	TH	Thailand
BI	Burundi	GS	S. Georgia & S. Sandwich Isls.	MT	Malta	TJ	Tadjikistan
BJ	Benin	GT	Guatemala	MU	Mauritius	TK	Tokelau
BM	Bermuda	GU	Guam (USA)	MV	Maldives	TM	Turkmenistan
BN	Brunei Darussalam	GW	Guinea Bissau	MX	Mexico	TN	Tunisia
BO	Bolivia	GY	Guyana	MY	Malaysia	TO	Tonga
BR	Brazil	HK	Hong Kong	MZ	Mozambique	TP	East Timor
BS	Bahamas	HM	Heard and McDonald Islands	NA	Namibia	TR	Turkey
BT	Bhutan	HN	Honduras	NC	New Caledonia (French)	TT	Trinidad and Tobago
BV	Bouvet Island	HR	Croatia	NE	Niger	TV	Tuvalu
BW	Botswana	HT	Haiti	NF	Norfolk Island	TW	Taiwan
BY	Belarus	HU	Hungary	NG	Nigeria	TZ	Tanzania
BZ	Belize	ID	Indonesia	NI	Nicaragua	UA	Ukraine
CA	Canada	IE	Ireland	NL	Netherlands	UG	Uganda
CC	Cocos (Keeling) Islands	IL	Israel	NO	Norway	UK	United Kingdom
CF	Central African Republic	IN	India	NP	Nepal	UM	USA Minor Outlying Islands
CG	Congo	IO	British Indian Ocean Territory	NR	Nauru	US	United States
CH	Switzerland	IQ	Iraq	NU	Niue	UY	Uruguay
CI	Ivory Coast	IR	Iran	NZ	New Zealand	UZ	Uzbekistan
CK	Cook Islands	IS	Iceland	OM	Oman	VA	Vatican City State
CL	Chile	IT	Italy	PA	Panama	VC	Saint Vincent & Grenadines
CM	Cameroon	JM	Jamaica	PE	Peru	VE	Venezuela
CN	China	JO	Jordan	PF	Polynesia (French)	VG	Virgin Islands (British)
CO	Colombia	JP	Japan	PG	Papua New Guinea	VI	Virgin Islands (USA)
CR	Costa Rica	KE	Kenya	PH	Philippines	VN	Vietnam
CS	Former Czechoslovakia	KG	Kyrgyzstan	PK	Pakistan	VU	Vanuatu
CU	Cuba	KH	Cambodia	PL	Poland	WF	Wallis and Futuna Islands
CV	Cape Verde	KI	Kiribati	PM	Saint Pierre and Miquelon	WS	Samoa
CX	Christmas Island	KM	Comoros	PN	Pitcairn Island	YE	Yemen
CY	Cyprus	KN	Saint Kitts & Nevis Anguilla	PR	Puerto Rico	YT	Mayotte
CZ	Czech Republic	KP	North Korea	PT	Portugal	YU	Yugoslavia
DE	Germany	KR	South Korea	PW	Palau	ZA	South Africa
DJ	Djibouti	KW	Kuwait	PY	Paraguay	ZM	Zambia
DK	Denmark	KY	Cayman Islands	QA	Qatar	ZR	Zaire
DM	Dominica	KZ	Kazakhstan	RE	Reunion (French)	ZW	Zimbabwe
DO	Dominican Republic	LA	Laos	RO	Romania		
DZ	Algeria	LB	Lebanon	RU	Russian Federation		
EC	Ecuador			RW	Rwanda		
EE	Estonia			SA	Saudi Arabia		
EG	Egypt			SB	Solomon Islands		
EH	Western Sahara						



## Specifications

<b>Television System</b>		DTV standard (1080i, 720p, 480p, 480i)
<b>Channel Coverage</b>		Terrestrial: 2-69, Cable: 1-135
<b>DVD</b>	<b>Laser</b>	Semiconductor laser, wavelength 650 nm
	<b>Frequency response</b>	DVD (PCM 96 kHz): 8 Hz to 44 kHz DVD (PCM 48 kHz): 8 Hz to 22 kHz CD: 8 Hz to 20 kHz
	<b>Signal-to-noise ratio</b>	More than 100dB (ANALOG OUT connectors only)
	<b>Harmonic distortion</b>	Less than 0.008%
	<b>Dynamic range</b>	More than 100 dB (DVD) More than 95 dB (CD)
<b>Input/Output</b>	<b>ATSC ANT Input</b>	ANT IN (1) (ATSC-8VSB over Terrestrial or QAM over cable)
	<b>ANT Loop Out</b>	Out To TV (1)
	<b>DVI Output</b>	DVI-HDTV Out (1), DVI-D Single Link connector 1080i, 720p, 480p digital RGB
	<b>Component Video Output</b>	Component Out (1 Set), Typical RCA type Jack connectors 1080i, 720p, 480p, 480i YPbPr
	<b>RGB Output</b>	RGB Out (1), 15-pin connector 1080i, 720p, 480p RGB
	<b>S-Video Output</b>	S-Video Out (1), 4-pin Mini-DIN 480i Y/C
	<b>Video Output</b>	Video Out (1), Typical RCA type Jack connector 480i Composite
	<b>Digital Audio Output</b>	Coaxial, Optical (Dolby Digital output)
	<b>Analog Audio Output</b>	Audio Out (2) (Variable Output Level)
	<b>Authorized Service Port</b>	9-pin Serial Port (1)
<b>Dimension (W x H X D)</b>		14.2 x 2.4 x 10.4 inches (430 x 76.5 x 345 mm)
<b>Weight</b>		7.7 lbs (4.4 kg)
<b>Power Requirements</b>		AC 120V, 60Hz
<b>Power Consumption</b>		30W
<b>Environment</b>	<b>Operating Humidity</b>	30 to 60 percent non condensing
	<b>Storage Temperature</b>	-20 to 60 degrees Celsius (-4 to 140 degrees Fahrenheit)
	<b>Operating Temperature</b>	0 to 35 degrees Celsius (32 to 95 degrees Fahrenheit)
<b>Accessories</b>	RF cable . . . . .	1
	Video cable . . . . .	1
	Audio (L/R) cable . . . . .	1
	Component (YPbPr) cable . . . . .	1
	Remote Control . . . . .	1
	Batteries (size AA) . . . . .	2

- Design and specifications are subject to change without prior notice.
- Manufactured under license from Dolby Laboratories. "Dolby" and the double-D symbol are trademarks of Dolby Laboratories.
- DTS is registered trademarks of Digital Theater Systems, Inc.



## Notes

## REFERENCE

## Notes

## Notes

## REFERENCE

**LG Electronics, Inc.**  
**HD RECEIVER / DVD PLAYER LST-3510A Limited Warranty - USA**



This LG Electronics product, marketed by Zenith, will be repaired or replaced, at LG's option, if it proves to be defective in material or workmanship, under normal use, during the warranty period ("Warranty Period") listed below, effective from the date ("Date of Purchase") of original consumer purchase of the product. This warranty is good only to the original purchaser of the product and effective only when used in the United States, excluding U.S. Territories.

<p><b>WARRANTY PERIOD:</b></p> <p><b>LABOR: 90 days</b> from the Date of Purchase.</p> <p><b>PARTS: One Year</b> from the Date of Purchase.</p> <p>* Parts replaced are warranted for the remaining portion of the original warranty period.</p>	<p><b>HOW SERVICE IS HANDLED:</b></p> <p><b>Call 1-800-243-0000</b> for instructions on getting the defective unit repaired or replaced.</p> <p><b>Please retain dated sales receipt and your box</b> to return the unit to LG for repair or replacement.</p> <p>Shipping both ways will be paid by LG during the Warranty Period. After the Warranty Period, you pay in-bound shipping charges and LG pays return shipping charges.</p> <p>Visit our website at: <a href="http://www.lgservice.com">http://www.lgservice.com</a></p>
--	---

**THIS WARRANTY IS IN LIEU OF ANY OTHER WARRANTIES, EXPRESS OR IMPLIED, INCLUDING WITHOUT LIMITATION, ANY WARRANTY OF MERCHANTABILITY OR FITNESS FOR A PARTICULAR PURPOSE. TO THE EXTENT ANY IMPLIED WARRANTY IS REQUIRED BY LAW, IT IS LIMITED IN DURATION TO THE EXPRESS WARRANTY PERIOD ABOVE. LG ELECTRONICS WILL NOT BE LIABLE FOR ANY INCIDENTAL, CONSEQUENTIAL, INDIRECT, SPECIAL OR PUNITIVE DAMAGES OF ANY NATURE, EVEN IF ADVISED OF THE POSSIBILITY OF SUCH DAMAGES, INCLUDING WITHOUT LIMITATION, LOST REVENUES OR PROFITS, LOST OR CORRUPTED PROGRAMMING OR DATA, OR ANY OTHER DAMAGE WHETHER BASED IN CONTRACT, TORT OR OTHERWISE.** Some states do not allow the exclusion or limitation of incidental or consequential damages or limitation on how long an implied warranty lasts, so the above exclusion or limitation may not apply to you. This warranty gives you specific legal rights and you may also have other rights that may vary from state to state.

**THIS LIMITED WARRANTY DOES NOT APPLY TO:**

- Damages or operating problems that result from shipping, installation, adjustment of user controls, calibration, maintenance or failure to maintain, or separate system components; and
- Damages or operating problems that result from normal wear and tear, misuse, abuse, operation outside environmental specifications or contrary to the requirements or precautions in the Operating Guide, accident, lightning strikes or other natural causes, unauthorized modification or alteration, incorrect electrical current or voltage, reception problem caused by inadequate home antenna or faulty antenna connections, computer software, institutional or commercial use, or other causes not arising out of defect in material or workmanship.

Therefore, the cost of repair or replacement of such defective product shall be borne by the consumer.

**CUSTOMER INTER-ACTIVE CENTER NUMBERS:**

<p><b>For nearest Authorized Service Center, Where to buy, Product Assistance, or Customer Assistance</b></p>	<p><b>Call 1-800-243-0000</b> (Monday - Friday 7 AM - 8PM CT and Saturday 8 AM - 5 PM CT) and select appropriate options from the menu.</p> <p>Or visit our website at <a href="http://www.lgservice.com">http://www.lgservice.com</a></p>
---	--

ZENITH ELECTRONICS CORPORATION  
 2000 MILLBROOK DRIVE  
 LINCOLNSHIRE, IL 60069

Zenith Part No. 506-1004  
 GS# 3835RS0061E  
 Printed in Korea  
 Issue O

## Free Manuals Download Website

<http://myh66.com>

<http://usermanuals.us>

<http://www.somanuals.com>

<http://www.4manuals.cc>

<http://www.manual-lib.com>

<http://www.404manual.com>

<http://www.luxmanual.com>

<http://aubethermostatmanual.com>

Golf course search by state

<http://golfingnear.com>

Email search by domain

<http://emailbydomain.com>

Auto manuals search

<http://auto.somanuals.com>

TV manuals search

<http://tv.somanuals.com>