



Wireless LCD TV

User's Guide
(15LW1R/15LW1RA)



Please read the "Safety Precautions" section carefully to use this product properly

Major Functions of Wireless LCD TV

Wireless TV Function

* Wireless transmission unit enables you to watch TV in a place where there is no antenna/cable connection available in a convenient location.

Media Player Function

* When connected to your PC, you can play back pictures, music files or video.

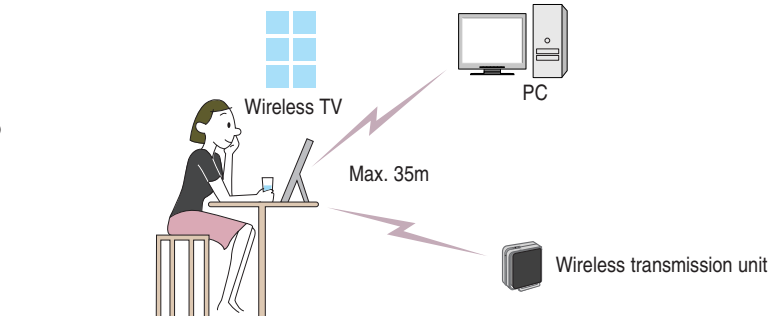

Note

- * The maximum usage distance is 35m; limited by obstacles or other interference to the wireless network.
- * A mosaic screen may appear if network connection is poor, since broadcasting is converted to the MPEG format before transmitted wirelessly.
- * Connection quality can be affected by other devices that transmit radio waves.
- * There is approximately a 1.5 second delay between the signal source and the display.

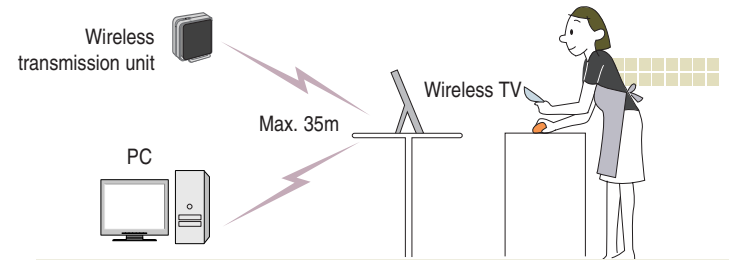

Thank you purchasing LG product. Please check whether the following accessories are included in the wireless TV package.

* Actual wireless TV and its accessories may look differently.

Wireless TV Accessories



Remote Control and Batteries (AAA x2)



User's Guide, Software, and other cards.



2 Power cords

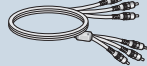

RCA cable

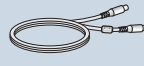

S-video cable



2 Antenna cables



Distributor (cable splitter)

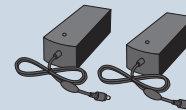

2 DC adaptors



TV battery pack



Mounting stand (only use with 15LW1R)

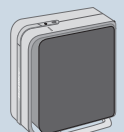

Wireless transmission unit

	Before you Use			
	Warning	04		
	Safety Information	05		
	SAR(Specific Absorption Rates) Information	06		
	Safety instructions	07		
	Safety Precautions	09		
	Name and Functions of Wireless TV Parts	16		
	Front/Upper view of the wireless TV:	16		
	Adjustment buttons			
	Rear view of the wireless TV/ wireless transmission unit	17		
	Watching the wireless TV using the mounting stand	18		
	(Only use with 15LW1R)			
	Wireless TV Battery pack	19		
	Installing a battery pack	19		
	Remote Control	20		
22	Connection and Usage			
	Power Connection	22		
	Connecting the Antenna	23		
	Connecting more than 2 TV Sets	24		
	Connecting VCR/DVD	25		
	Connecting Cable TV Converter	26		
	Connecting External Devices like a Camcorder	27		
28	Adjustment when Using the Wireless TV			
	Watching the Wireless TV	28		
	Language Selection	29		
	On-screen Menus Language Selection	29		
	Programming the Channels	30		
	Memorizing all broadcasting channels	30		
	Memorizing or clearing the specific channels	30		
	Setting Favorite Channels	31		
	Watching the selected channel only	31		
	Adjusting the Picture	32		
	Adjusting the picture automatically	32		
	Adjusting contrast	32		
	Adjusting brightness	33		
	Adjusting depth of color	33		
	Adjusting sharpness	34		
	Adjusting tint	34		
	Adjusting Sound	35		
	Adjusting best sound automatically	35		
	Using the SAP (Secondary Audio Program) function	35		
	AVL (Auto Volume Leveler)	36		
	Adjusting sound balance	36		
	Special Menu Options	37		
	Selecting the Input Signal	37		
	Watching the Program with Caption Text	37		
	Settings the Captions	38		
	Closed Captions	39		
	Setting the Sleep Timer	40		
	Setting the key lock	40		
	Parental Lock Options	41		
	Setting the lock function	41		
	Changing the password setting	41		
43	Using Media Browser			
	Using Media Browser	43		
	Setting the wireless network (Setting method 1)	43		
	Setting the wireless network in the Computer	45		
	Installing the "Media Library" Server in you computer	47		
	Setting Wireless Network (Setting method 2)	50		
	Using Media Library Manager	53		
	Viewing Pictures	54		
	Playing Musics	56		
	Playing Movies	59		
	Changing Settings	61		
62	Note			
	Check before reporting malfunction	62		
	Product Specification	66		

Warning

NOTE TO CABLE/TV INSTALLER:

This reminder is provided to call the CATV system installer's attention to Article 820-40 of the National Electric Code (U.S.A.).

The code provides guidelines for proper grounding and, in particular, specifies that the cable ground shall be connected to the grounding system of the building, as close to the point of the cable entry as practical.

REGULATORY INFORMATION

This equipment has been tested and found to comply with the limits for a Class B digital device, pursuant to Part 15 of the FCC Rules. These limits are designed to provide reasonable protection against harmful interference in a residential installation. This equipment generates, uses and can radiate radio frequency energy and, if not installed and used in accordance with the instructions, may cause harmful interference to radio communications.

However, there is no guarantee that interference will not occur in a particular installation. If this equipment does cause harmful interference to radio or television reception, which can be determined by turning the equipment off and on, the user is encouraged to try to correct the interference by one or more of the following measures:

- Reorient or relocate the receiving antenna.
- Increase the separation between the equipment and receiver.
- Connect the equipment into an outlet on a circuit different from that to which the receiver is connected.
- Consult the dealer or an experienced radio/TV technician for help.

Any changes or modifications not expressly approved by the party responsible for compliance could void the user's authority to operate the equipment.

CAUTION:

Do not attempt to modify this product in any way without written authorization from LG Electronics Corporation. Unauthorized modification could void the user's authority to operate this product.

U.S.A. only -----**COMPLIANCE:**

The responsible party for this product's compliance is:

LG Electronics U.S.A., Inc.

1000 Sylvan Avenue, Englewood Cliffs, NJ 07632

Phone: 1-201-816-2000

<http://www.lgusa.com>

Safety Information

SAFETY INFORMATION FOR FIXED WIRELESS TERMINALS

POTENTIALLY EXPLOSIVE ATMOSPHERES

Turn your TV OFF when in any area with a potentially explosive atmosphere and obey all signs and instructions. Sparks in such areas could cause an explosion or fire resulting in bodily injury or even death.

INTERFERENCE TO MEDICAL DIVICES

Certain electronic equipment may be shielded against RF signal from you wireless TV. (Pacemakers, Hearing Aids, and so on) Turn your TV OFF in health care facilities when any regulations posted in these areas instruct you to do so.

RF signals may affect improperly installed or inadequately shielded electronic system in motor vehicles.

EXPOSURE TO RF ENERGY

Use only the supplied or an approved replacement antenna.

Do not touch the antenna unnecessarily when the TV is in use.

SAFETY INFORMATION FOR RF EXPOSURE

BODY WORN OPERATION

This device was tested for typical body-worn operations with the back of the TV kept 15 mm. from the body. To maintain compliance with FCC RF exposure requirements, use only belt-clips, holsters or similar accessories that maintain a 15 mm.

Separation distance between the user's body and the back of the TV, including the antenna. The use of belt-clips, holsters and similar accessories should not contain metallic components in its assembly. The use of accessories that do not satisfy these requirements may not comply with FCC RF exposure requirements, and should be avoided.

SAR (Specific Absorption Rates) Information

THIS MODEL TV MEETS THE GOVERNMENT'S REQUIREMENTS FOR EXPOSURE TO RADIO WAVES.

Your wireless TV is a radio transmitter and receiver. It is designed and manufactured not to exceed the emission limits for exposure to radiofrequency (RF) energy set by the Federal Communications Commission of the U.S. Government. These limits are part of comprehensive guidelines and establish permitted levels of RF energy for the general population. The guidelines are based on standards that were developed by independent scientific organizations through periodic and thorough evaluation of scientific studies. The standards include a substantial safety margin designed to assure the safety of all persons, regardless of age and health. The exposure standard for wireless TV employs a unit of measurement known as the Specific Absorption Rate, or SAR. The SAR limit set by the FCC is 1.6 W/kg. *Tests for SAR are conducted with the TV transmitting at its highest certified power level in all tested frequency bands. Although the SAR is determined at the highest certified power level, the actual SAR level of the TV while operating can be well below the maximum value. This is because the TV is designed to operate at multiple power levels so as to use only the power required to reach the network. In general, the closer you are to a wireless base station antenna, the lower the power output. Before a TV model is available for sale to the public, it must be tested and certified to the FCC that it does not exceed the limit established by the government adopted requirement for safe exposure. The tests are performed in positions and locations (e.g., at the ear and worn on the body) as required by the FCC for each model. The highest SAR value for this model when tested for use when worn on the body, as described in this user guide, is 0.094 W/Kg (Wireless Transmission Unit), 0.200 W/Kg(Wireless TV). (Body-worn measurements differ among models, depending upon available accessories and FCC requirements). While there may be differences between the SAR levels of various and at various positions, they all meet the government requirement for safe exposure. The FCC has granted an Equipment Authorization for this model with all reported SAR levels evaluated as in compliance with the FCC RF exposure guidelines. SAR information on this model is on file with the FCC and can be found under the Display Grant section of <http://www.fcc.gov/oet/fccid> after searching on FCC ID: BEJ15LW1T(Wireless Transmission Unit), BEJ15LW1R(Wireless TV).

Additional information on Specific Absorption Rates (SAR) can be found on the Cellular Telecommunications Industry Association (CTIA) web-site at <http://www.wow-com.com>.

* In the United States and Canada, the SAR limit for mobile TV used by the public is 1.6 watts/kg (W/kg) averaged over one gram of tissue.

The standard incorporates a substantial margin of safety to give additional protection for the public and to account for any variations in measurements.

Safety instructions

WARNING:

To reduce the risk of fire or electric shock, DO NOT expose this apparatus to rain or moisture.

Apparatus shall not be exposed to dripping or splashing and no objects filled with liquids, such as vases, shall be placed on the apparatus.

IMPORTANT SAFETY INSTRUCTIONS

1. Read these instructions.
2. Keep these instructions.
3. Heed all warnings.
4. Follow all instructions.
5. Do not use this apparatus near water.
6. Clean only with a dry cloth.
7. Do not block any of the ventilation openings. Install in accordance with the manufacturer's instructions.
8. Do not install near any heat sources such as radiators, heat registers, stoves, or other apparatus (including amplifiers) that produce heat.
9. Do not defeat the safety purpose of the polarized or grounding type plug. A polarized plug has two blades with one wider than the other. A grounding type plug has two blades and a third grounding prong. The wide blade or the third prong is provided for your safety. When the provided plug does not fit into your outlet, consult an electrician for replacement of the obsolete outlet.
10. Protect the power cord from being walked on or pinched particularly at plugs, convenience receptacles, and the point where they exit from the apparatus.
11. Only use the attachments / accessories specified by the manufacturer.
12.  Use only with a cart, stand, tripod, bracket, or table specified by the manufacturer, or sold with the apparatus. When a cart is used, use caution when moving the cart / apparatus combination to avoid injury from tip-over.

S3125A

Safety instructions continued

13. Unplug this apparatus during lightning storms or when unused for long periods of time.
14. Refer all servicing to qualified service personnel. Servicing is required when the apparatus has been damaged in anyway, such as power supply cord or plug is damaged, liquid has been spilled or objects have fallen into the apparatus, the apparatus has been exposed to rain or moisture, does not operate normally, or has been dropped.

On Disposal

- a. The fluorescent lamp used in this product contains a small amount of mercury.
- b. Do not dispose of this product with general household waste.
Disposal of this product must be carried out in accordance to the regulations of your local authority.

FCC Compliance Information

This device complies with Part 15 of FCC Rules.
Operation is subject to the following two conditions:

- (1) This device may not cause harmful interference, and
- (2) This device must accept any interference received.
Including interference that may cause undesired operation.

Safety Precautions

The following safety precautions are provided to prevent an unexpected accident or damage, through safe and accurate usage of the product.

Safety precautions can be grouped into "Warning" and "Caution" and have the following meaning.

- ⚠ Warning: If instruction is ignored or violated, you can be seriously injured or even killed.
 - ⚠ Caution: If instruction is ignored or violated, you can be slightly injured or the product can be damaged.
 - ⊘ Prohibited: You must not do the thing described after this symbol.
- Please keep this User's Guide at the place where everybody can easily access, after reading this User's Guide.

⚠ WARNING if instruction is ignored or violated, you can be seriously injured or even killed.

Installation



If smoke, strange sounds, or a bad smell emanates from the product, unplug and contact a service center.

You can receive an electric shock or a fire can break out.



Do not put heavy objects on the TV or let children or pets crawl on the TV.

Warn the children against injury by collapsing or falling down.



Keep anti-moisture packages, bags, and other packing materials out of reach of children.

If swallowed by mistake, induce vomiting and consult a doctor immediately.

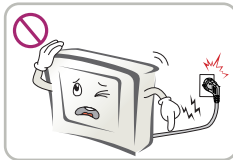

Take care in placements of cables; do not cross walking paths.

If somebody is caught by the cord and collapses, he can receive an electric shock or be injured, or the product can be damaged



Do not insert any metallic object such as coin, hairpin, etc. or combustible object. Also warn children not to do so.

You could receive an electric shock or it could cause a fire. If any foreign object is inserted, unplug the power cord and contact a service center.

Safety Precautions

Usage

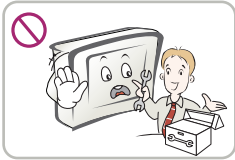

Only a qualified technician should disassemble, repair or modify the product.

You could receive an electric shock or it could cause a fire.



Do not put a fluid container such as flower vase, flowerpot, cup, cosmetics or medical supplies as well as decorations or candles on the wireless TV or wireless transmission unit.

You could receive an electric shock or it could cause a fire.

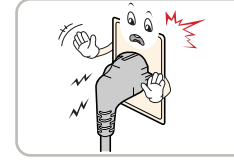

If you detect a gas leakage, do not touch the TV or turn it.

It could cause a fire.

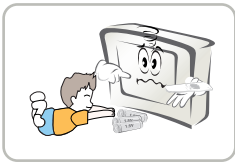

Keep the remote batteries out of reach of children.

If a child swallows the battery, consult a doctor immediately.

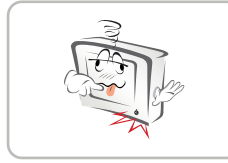

Do not use the product while it has defects like no video or no sound. Turn the product off, unplug it, and contact a service center.

You could receive an electric shock or it could cause a fire.

Safety Precautions

Power Related Precautions

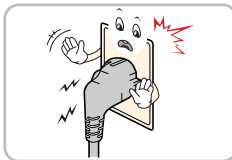

Ensure the power cable is connected properly to the grounded power outlet.

You could receive an electric shock.

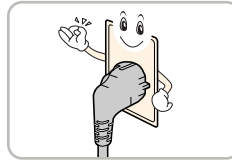

Use the specified rated voltage.

The wireless TV can be damaged, or you can be injured.

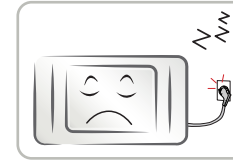

Unplug the product when not in use for a long time.

The product can be covered with dust, which can cause electric leakage, electric shock or fire due to heating, ignition or worn-out insulation.

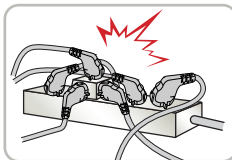

Do not use several devices at the same time when using a power strip. Use a grounded power strip designed for computers.

A fire may break out due to overheating.

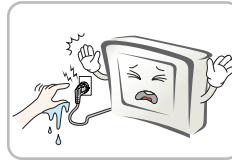

Do not touch the power plug with wet hands. If the power connector is wet or covered with dust, dry it completely or scrub it off before use.

You could receive an electric shock.

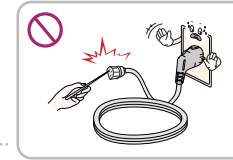

Do not insert any conductive material into the opening of the power cable.

You could receive an electric shock.

CAUTION concerning the Power Cord

Most appliances recommend they be placed upon a dedicated circuit; that is, a single outlet circuit which powers only that appliance and has no additional outlets or ranch circuits. Check the specification page of this owner's manual to be certain.

Do not overload wall outlets. Overloaded wall outlets, loose or damaged Wall outlets, extension cords, frayed power cords, or damaged or cracked wire insulation are dangerous. Any of these conditions could result in electric shock or fire. Periodically examine the cord of your appliance, and if its appearance indicates damage or deterioration, unplug it, discontinue use of the appliance, and have the cord replaced with an exact replacement part by an authorized servicer.

Protect the power cord from physical or mechanical abuse, such as being twisted, kinked, pinched, closed in a door, or walked upon.

Pay particular attention to plugs, wall outlets, and the point where the cord exits the appliance.

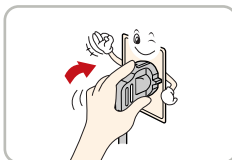

Firmly plug in the power plug so that it does not shake.

A plug not connected firmly is a fire hazard.

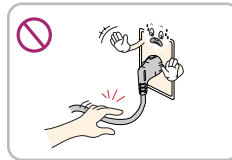

Hold the plug with your hand when pulling out the power cable. Do not bend the cord with excessive force, or put a heavy object on it.

An electric wire can be damaged, which can cause an electric shock or a fire.

Safety Precautions

⚠ CAUTION If instruction is ignored or violated, you can be slightly injured or the product can be damaged.

Installation

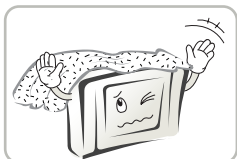

Ensure that ventilation openings are not blocked by a tablecloth, curtain or similar material.
The product could be damaged due to the internal temperature rising or it could cause a fire.

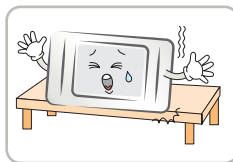

Install the product on a flat and stable surface that has no risk of moving or collapsing.
If the product falls you can be injured or the product could be broken.

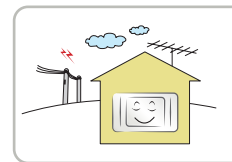

Install the product in a place free of electromagnetic interference.

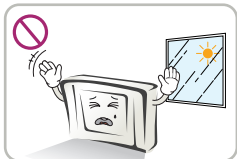

Do not install the product in direct sunlight.
The product could be damaged or a fire can break out.

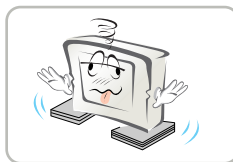

Do not install the product on an unstable and vibrating surface.
The product could fall or be turned over, which could cause injury.



Do not install the product where it may have direct contact with oil or moisture – such as beside a kitchen table or a humidifier.
You could receive an electric shock or it could cause a fire.

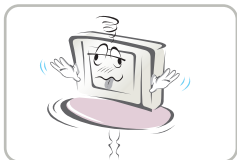

When installing in an entertainment center or on a shelf, ensure that the front of the product is not projecting out beyond the front of the cabinet or shelf.
The centre of gravity can be unbalanced, which could cause an injury or breakdown of the product.

Safety precautions

Movement

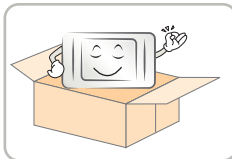

Do not throw away the original packing and box.

Use the package box when moving the product.



Do not drop or bang the device when carrying or transporting.

You could be injured or the product could be damaged.

Power Related Precautions

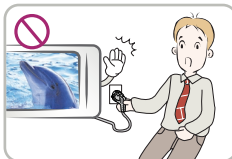

Do not unplug the power cord while the device is on and the battery is not mounted.

The product could be damaged by electric shock.



If the power plug or the outlet is covered with dust, clean it.

It could cause a fire.

Cleaning



Consult with customer service or a service center about cleaning once a year.

A fire can break out or the product is broken or if you don't clean the product.



Unplug the power cable, the signal cable, and the battery before cleaning the product.

You could receive an electric shock or it could cause a fire.

Safety Precautions

Usage

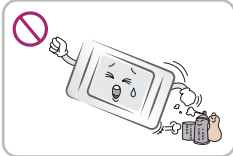

Do not use or store flammable materials close to the product.
It could cause a fire.

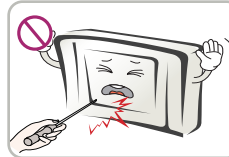

Do not press or scratch the panel with sharp objects (nail, pencil, or pen).
A panel can be easily damaged or broken.

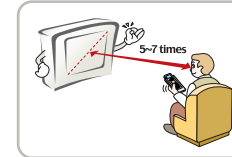

Viewing distance from the product should be about 5 ~ 7 times of the diagonal distance of the screen.

Your vision can be impaired if you watch the TV too closely for a long time.

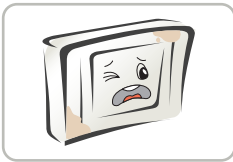

Always keep the product clean.



Use a mild lens cleaner to clean the screen. (Do not use benzene, thinner, or alcohol.)
The product can be deformed.

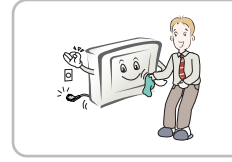

Unplug the power cord and wipe with a soft cloth instead of a wet cloth.

If water infiltrates through a crevice it could cause an electric shock accident or product breakdown.

Others

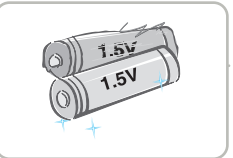

Do not mix new and old batteries.
It could cause the batteries to leak.

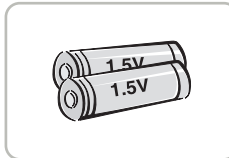

Do not use a battery that is not designated by the manufacturer.

Safety Precautions

Battery pack

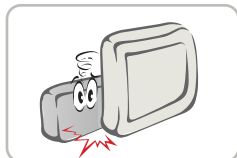

Do not charge the battery pack using another power supply device or circuit.

The battery pack can be damaged.



Do not throw away the used battery pack carelessly.

There is a risk of an explosion or a fire. Disposal method can be different for each country or region.
Use the proper disposal method.

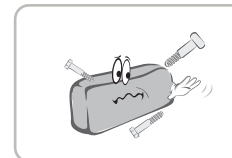

Do not throw or disassemble the battery pack.

There is a risk of a fire or an explosion due to a damaged battery pack.



Only use a battery pack approved and certified by LG Electronics.

There is a risk of an explosion or a fire.

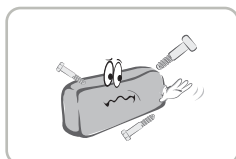

Do not keep the battery pack close to a metallic object like a key or a clip.

The battery pack could be damaged, it could cause a fire, or you could be burned due to rapid temperature rising by over-current.

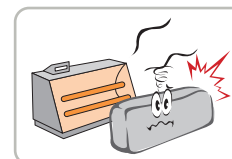

Do not store the product near a heat-generating item like a heater.

It could cause a fire or the product could be damaged.

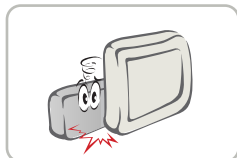

Be careful the battery pack terminals do not short circuit.

There is a risk of an explosion.

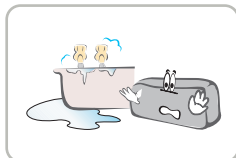

Do not store high temperature (over 60 degrees) or humidity area.

There is a risk of an explosion or a fire.



Keep out of reach of the children.

Children could be injured or the product could be broken.



Ensure that the battery pack is firmly inserted.

There is a risk of an explosion or a fire.

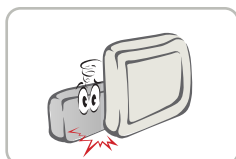

Handle the battery pack with care since it contains lithium.

There is a risk of an explosion or a fire.

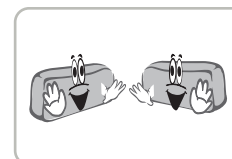

Use the same type of battery pack when replacing with a new one.

Name and Functions of Wireless TV Parts

Front view of wireless TV: Adjustment buttons



Upper view of the wireless TV: Adjustment buttons

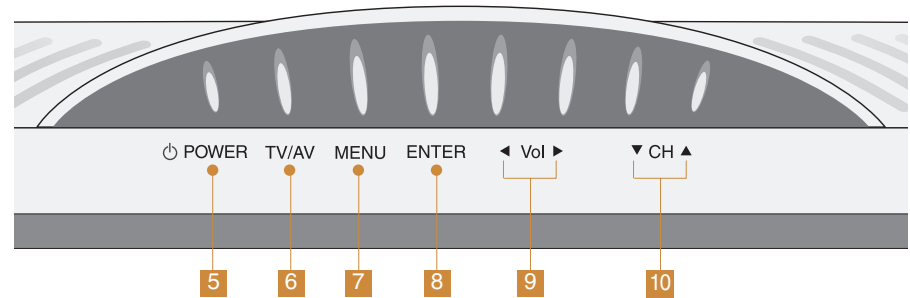

- 1 **Network status LED** Shows the status of the wireless transmission unit in the system or connection to the computer.
- 2 **Battery status LED** Shows the battery status of the system. For more details, [see page 19](#).
- 3 **Remote controller sensor**
- 4 **Power/Standby indicator** Shows blue color under normal operation. Brightness becomes dimmer as time goes by.

- 5 **Power button** Press the button to turn on and press again to turn off.
- 6 **TV/AV button** Each time you press this button, the signal will be switched in the following order.

TV

 ->

Video

 ->

S-Video
- 7 **Menu button** Shows/Hides the OSD (On Screen Display) menu screen while the wireless TV is on.
- 8 **ENTER button** Displays the channel/battery information while the wireless TV is on. Or, you will save the wireless TV adjustment settings.
- 9 **Volume button** Adjusts the volume.
- 10 **Channel button** Adjusts the channel.

Name and Functions of Wireless TV Parts

Rear view of the wireless TV

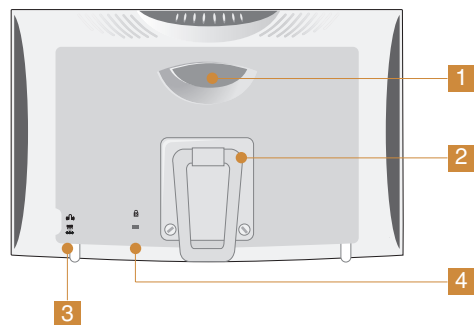

Wireless transmission unit

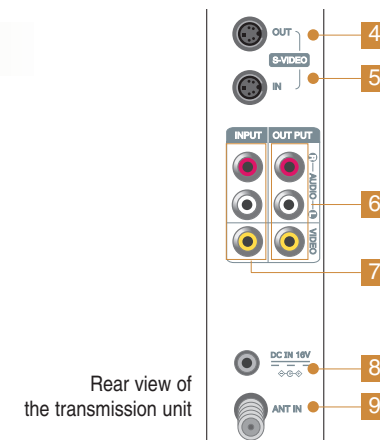
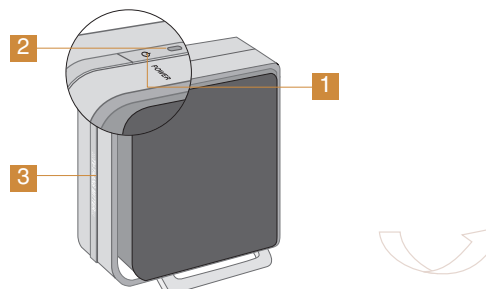

Rear view of the transmission unit

Rear view of the wireless TV

- 1 **Handle**
- 2 **Stand** You can insert a battery by separating a stand. Or you can connect to the VESA standard counterpart object by separating a stand. (See the below figure)
- 3 **Headphone/Earphone**
DC adaptor port
Connect to the power
- 4 **Theft prevention locking device**
This device is used to prevent theft by connecting the locking cable (optional). See the below figure.

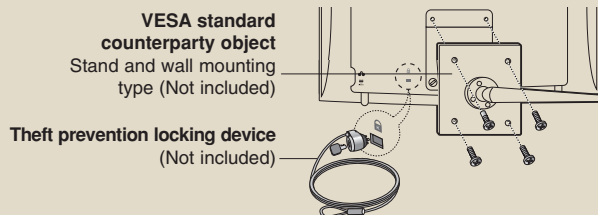

Theft prevention locking device

- This TV is equipped with a Kensington Security System connector on the back panel. The Kensington Security System is an optional accessory. For further information, visit <http://www.kensington.com>. Kensington sells security systems for expensive electronic equipment such as notebook PCs and LCD projectors.
- The Kensington Security System is an optional accessory.

Wireless Transmission Unit

- 1 **Power Button** Press the button to turn on and press again to turn off.
- 2 **Power/Standby indicator** Shows the power status of the wireless transmission unit. Red during normal operation and yellow while in standby mode.
- 3 **Network status indicator** Wireless TV connection indicator. Blue when a network connection has been established with wireless TV.
- 4 **S-video output port**

- 5 **S-video input port**
- 6 **AV output port**
- 7 **AV input port**
- 8 **DC adaptor port**
Connect to the adaptor.
- 9 **Antenna input port**
Connect of an antenna or cable TV connection.

RS-232C (Bottom of the wireless TV, bottom of the wireless transmission unit)
Service port. Only to be used by a qualified servicer.



Wireless TV stand

Watching the wireless TV using the mounting stand (Only use with 15LW1R)

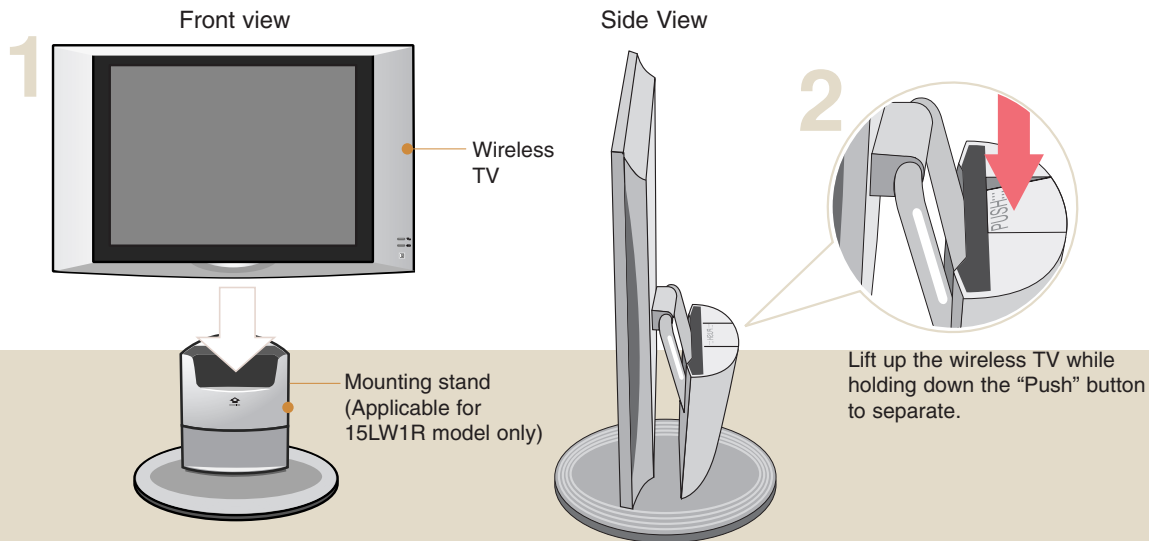

When watching the wireless TV using the mounting stand
Adjust the angle of the stand as shown below.

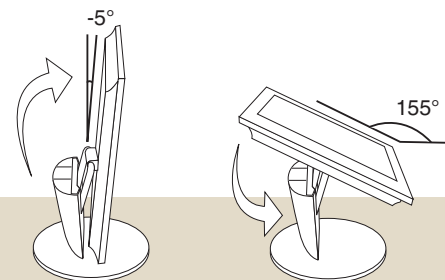

When watching the wireless TV using the wireless TV stand.

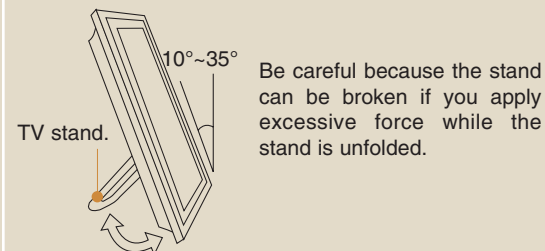

You can watch the wireless TV at any angle using the mounting type stand.

Unfold the wireless TV stand and put it on the mounting stand.

If the stand is not fixed properly, the stand can be separated and broken down.

Press the TV until you hear a "click" sound to fix it in place firmly.

Wireless TV Battery pack

Installing a battery pack

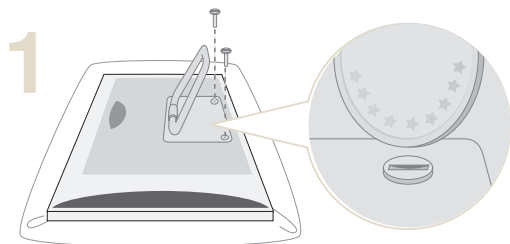

Cover the floor with soft cloth or a cushion. Place the wireless TV face down and unfold the TV's stand. Unscrew the screws at both sides as shown in the figure. You can use a coin or a screwdriver to loosen the screws.

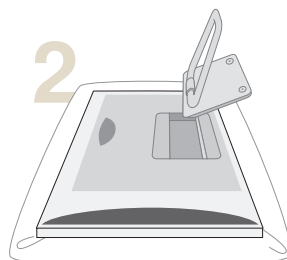

Separate the wireless TV stand.

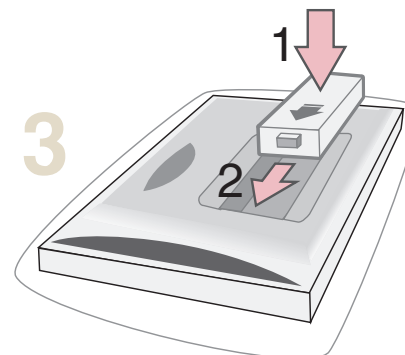

Insert the battery pack down into the battery pack holder (1), then slide it left (2).

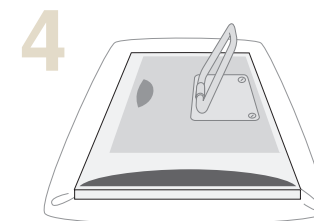

Replace the cover and screws after installing the battery pack.

To charge the battery

1. Connect the DC adaptor to the wireless TV.
2. Connect the power cord to the DC adaptor and then, connect to the power supply.

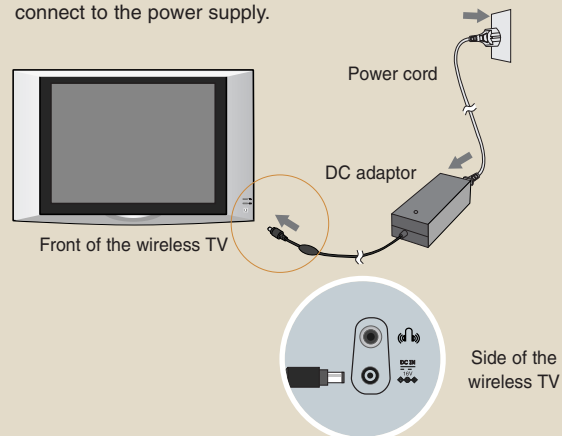

Battery pack Status LED

When using the battery pack (DC adaptor is not connected)	Remaining Amount (%)	Status LED Color
	30 ~ 100	Green
	10 ~ 30	Yellow
	Under 10	Yellow (blinking)
	0	off

When charging the battery pack (DC adaptor is connected)	Charging Amount (%)	Status LED Color
	Under 97	Yellow
	Over 98	Green

Battery pack Charging and Maximum Usage time

When charging the battery pack (DC adaptor is connected)	If TV is on	Max. 6 hours
	If TV is off	Max. 4 hours
Maximum battery pack usage time	If TV is on	Max. 3 hours

* The maximum battery pack usage time can differ according to the usage temperature or usage duration.

* If the battery pack is not used for a long time, it can be discharged. In this case, charge the battery pack first before use.

Remote Control

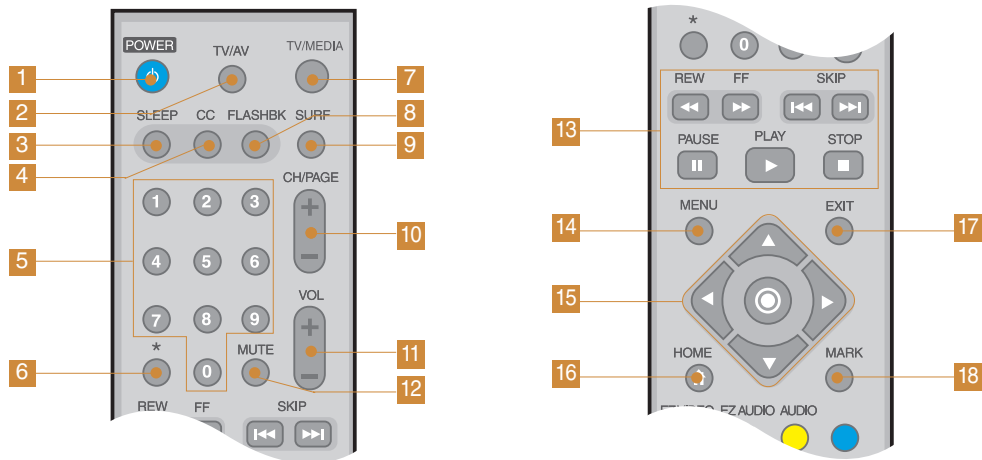

How to change the batteries

Slide the battery cover downward to open it. Then, insert the batteries (1.5V, 2 AAA type alkaline batteries) to the (+) and (-) direction as marked inside the remote control battery holder. Then, close the cover.

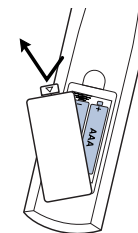

- Put used batteries into a recycling bin.

1 POWER

2 TV/AV

Each time you press the button, **TV -> Video -> S-Video** will be displayed sequentially.

3 SLEEP

TV will be automatically turned off after a certain amount of time. Set the time duration you want by pressing this button repeatedly.

4 CC

See page 37.

5 NUMBER buttons

6 * No function

7 TV/MEDIA

Use this button to use the Media Browser in the TV, or vice versa.

8 FLASHBK

Use this button to select the previous channel.

9 SURF

See page 31.

10 CH/PAGE

TV: Changes the channel.
Media Browser: Moves the list page by page.

11 VOL

Use this button to adjust the volume.

12 MUTE

Use this button to suppress the sound from the speaker.

13 Media handling buttons

Used in the Media Browser.

14 MENU

TV: Adjusts the TV functions.
Media Browser: Moves to the setting screen.
Moves to the previous menu in the Menu screen.

15 MOVE/SELECT buttons

TV: Changes TV/AV settings.
Media Browser: Moves the list.

16 HOME

Media Browser: Moves to the home screen.

17 EXIT

TV: Hides the Menu screen.
Media Browser: Stops the slide show.

18 MARK

Media Browser: Selects the list or cancels list selection.

Remote Control

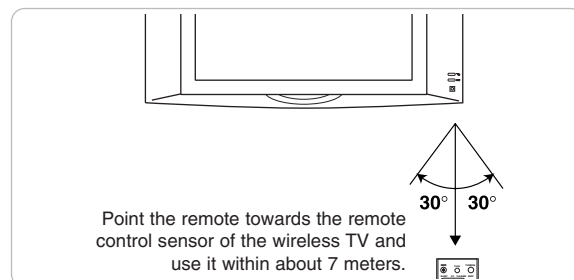
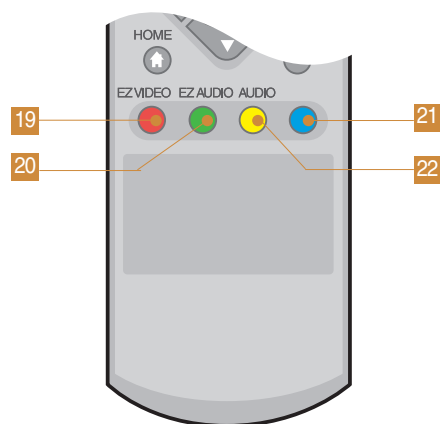

19 EZ VIDEO

TV: Adjusts the screen status to your preference. (See page 32)

Media Browser: Arranges the list.

20 EZ AUDIO

TV: Adjust the audio status to your preference. (See page 35)

Media Browser: Selects multiple files.

21 **Media Browser:** Starts the slide show, Plays back the music file randomly, Shows/Hides the movie caption.

22 AUDIO

Each time you press the button, **Mono -> Stereo -> SAP** will be displayed sequentially. (See page 35)

Media Browser: Plays back the music file repetitively.

Power Connection

Connect the power as shown in the following figure to use the wireless TV.

Connecting the electric power to the wireless TV

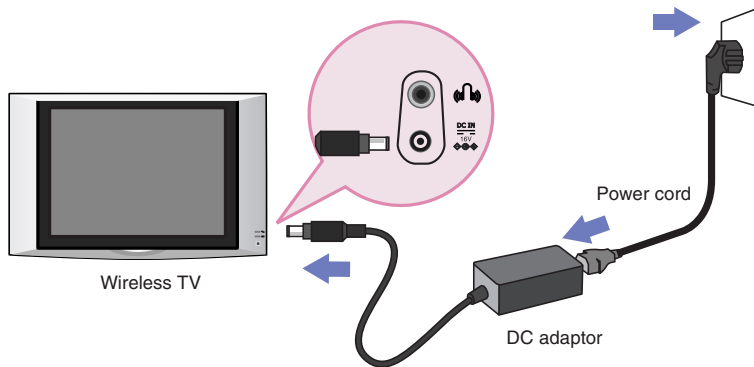

Connecting the electric power to the wireless transmission unit

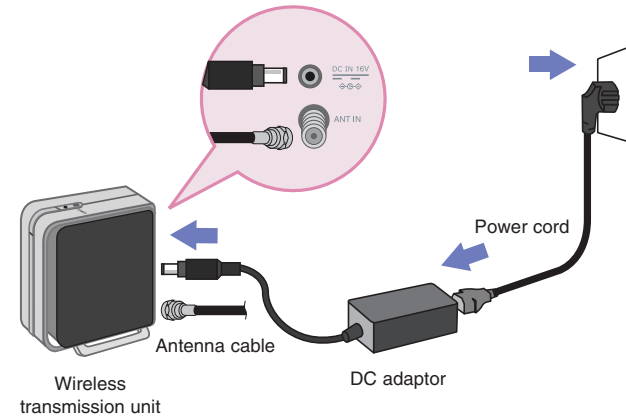

Connecting the Antenna

- For optimum picture quality, adjust antenna direction.

Connecting to an Inside Antenna Setup

- Typical wall antenna jack used in apartment buildings, connect the antenna cable as shown below.
(Use the correct type of antenna cable for the type of wall antenna jack.)

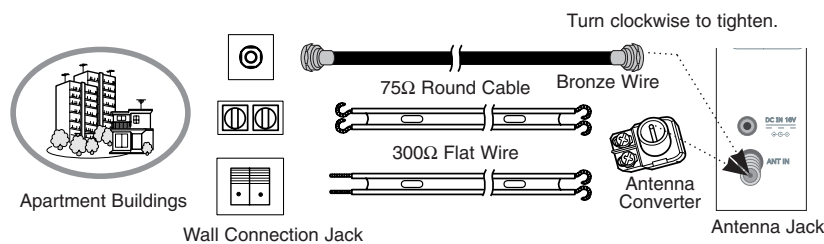

Connecting to an Outdoor Antenna Setup

- This type of antenna is commonly used in single family dwellings.

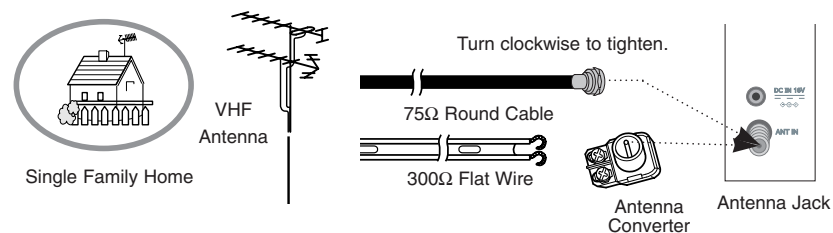

- If you have a 75Ω round cable, insert the bronze wire and then tighten the connection nut. If you have a 300Ω flat wire, connect the twisted wire to the antenna converter and then connect the converter to the antenna jack on the TV.

- If using 75Ω round cable, do not bend the bronze wire. It may cause poor picture quality.

Necessary Connection Cable

- Antenna cable (Not included)



Note

- You can enjoy a better quality screen in a weak radio reception area if you install a radio amplifier (booster).
- If you have difficulty in installing the antenna, consult a specialized antenna dealer or the sales shop you purchased the antenna from.
- Do not attach the wireless transmission unit to the wall.
- If you find a mosaic pattern on the screen or the screen is not displayed properly due to poor network connection, set the front side of the wireless transmission unit to face towards the wireless TV.

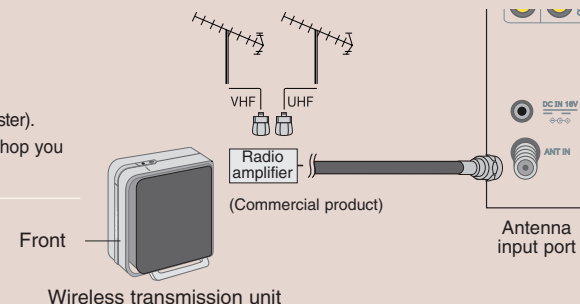

Connecting more than 2 TV Sets

- Connect the connection port with the same color.
- Use the S-Video connection instead of Composite Video (RCA Cables) when available for better quality.
- If the input only supports mono, only the left (white) channel needs to be connected.

1 Connecting antenna cables using the distributor.

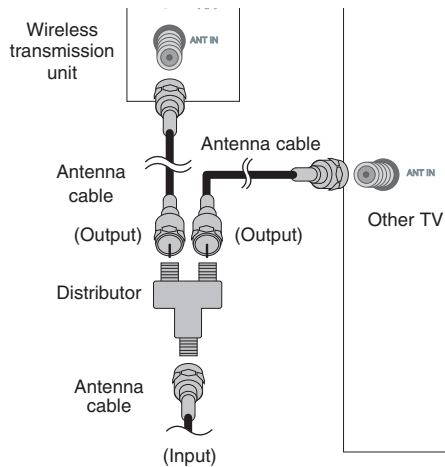

2 Connecting with RCA cables.

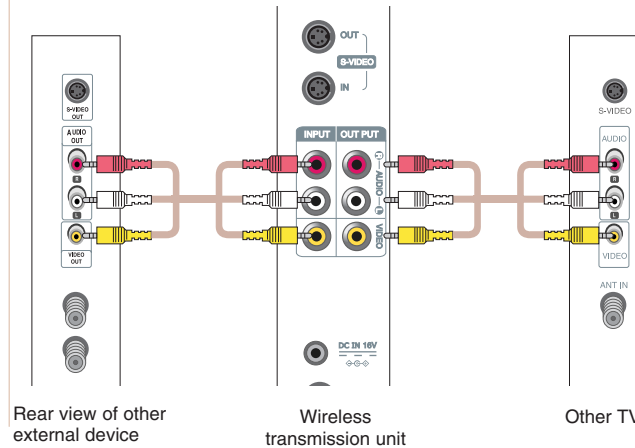

3 Connecting with S-Video cables.

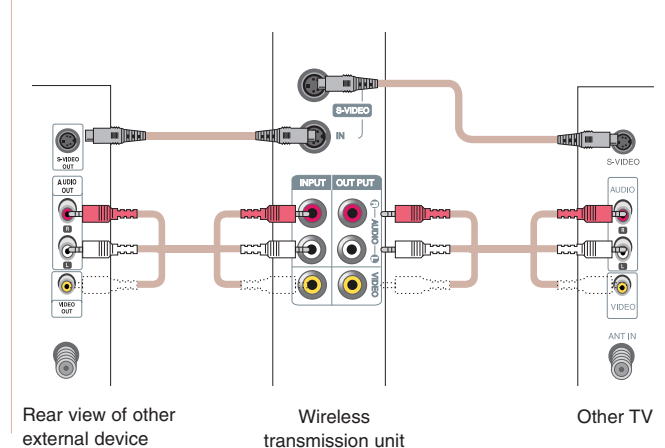

Necessary Connection Cables

- RCA cable
- S-Video cable
- Antenna cable (Not included)



Note

- Do not attach the wireless transmission unit to the wall.
- If you find a mosaic pattern on the screen or the screen is not displayed properly due to poor network connection, set the front side of the wireless transmission unit to face towards the wireless TV.
- If you connect more than 2 TV sets, the image quality may deteriorate.

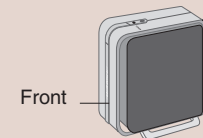

Wireless transmission unit

Connecting VCR/DVD

- Connect the connection port with the same color when connecting the wireless transmission unit to the external device.
- Use the S-Video connection instead of Composite Video (RCA Cables) when available for better quality.
- If the input only supports mono, only the left (white) channel needs to be connected.
- An after image can occur when stationary objects (text, logo, etc) remain on the screen for a long period.

Connecting with antenna cables

- 1 Turn on the wireless TV and select channel #3 or #4 using the TV remote control. 



Connecting with Composite Video or S-Video

- 2 Press the **TV/AV** button on the remote control and select the **Video** Input. 

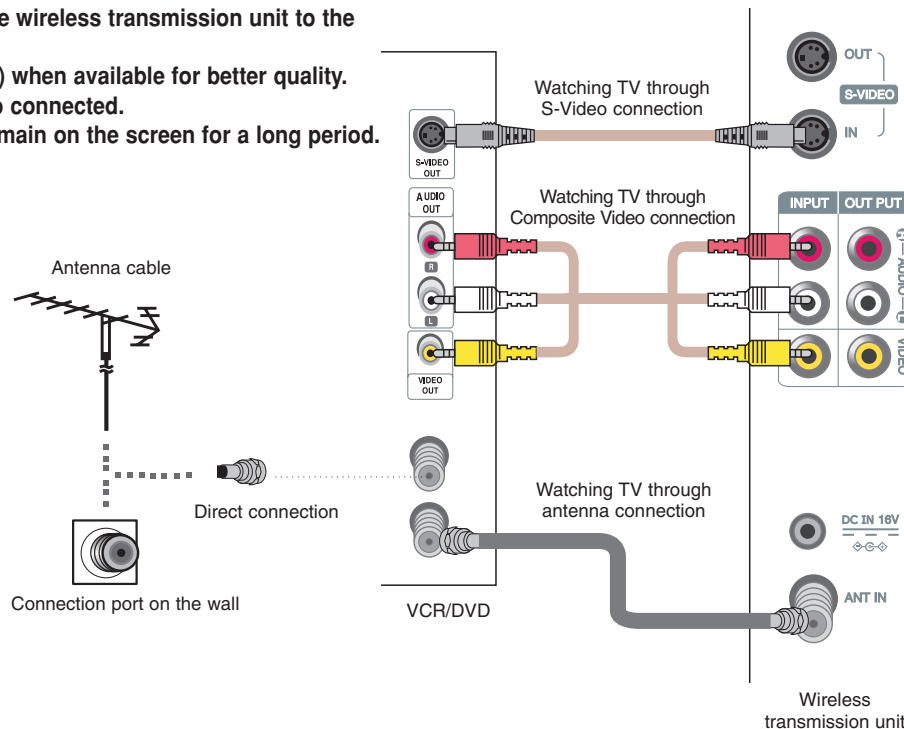
Insert a tape into the video player and press the **PLAY** button.

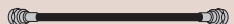

Necessary Connection Cables

- RCA cable 
- S-Video cable 
- Antenna cable (Not included) 



Note

- You can also play back the video in TV channel #3 or #4. However, the selected channel number should be identical to channel switch selection at the rear side of the video.
- While in Video input mode, press the **CH (+, -)** button, **SURF** or **FLASHBK** button to return to TV mode.
- Do not attach the wireless transmission unit to the wall.
- If you find a mosaic pattern on the screen or the screen is not displayed properly due to poor network connection, set the front side of the wireless transmission unit to face towards the wireless TV.

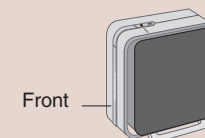

Front
Wireless transmission unit

Connecting a Cable TV Converter

- Connect the connection port with the same color when connecting the wireless transmission unit to the external device.
- To watch the cable TV, you should subscribe to the local CATV broadcasting service provider and install the converter separately.

When connection with Composite Video

How to use

- 1 Press the **TV/AV** button on the remote control and select **Video** Input. 
- 2 Select the channel you want using the converter remote control.

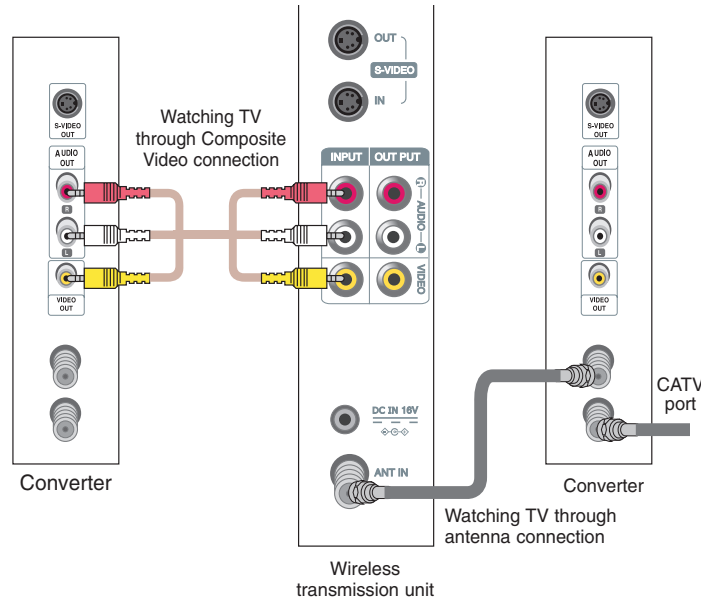



When connecting with the antenna

How to use

- 1 Set the exclusive channel selection switch of the converter to channel #3 or #4.
- 2 Set the TV channel number to the same as converters channels selection switch.
- 3 Select the channel you want using the converter remote control.

Necessary Connection Cables

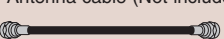
- RCA cable 
- S-Video cable 
- Antenna cable (Not included) 



Note

- Follow the instructions from the local CATV service provider for more details on the CATV connection usage.
- Do not attach the wireless transmission unit to the wall.
- If you find a mosaic pattern on the screen or the screen is not displayed properly due to poor network connection, set the front side of the wireless transmission unit to face towards the wireless TV.

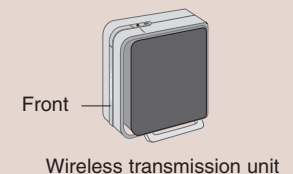

Wireless transmission unit

Connecting External Devices like a Camcorder

- Connect the connection port with the same color when connecting the wireless transmission unit to the external device.

How to use

- 1 Press the **TV/AV** button on the remote control and select **Video Input**.
- 2 Start the Video input device.

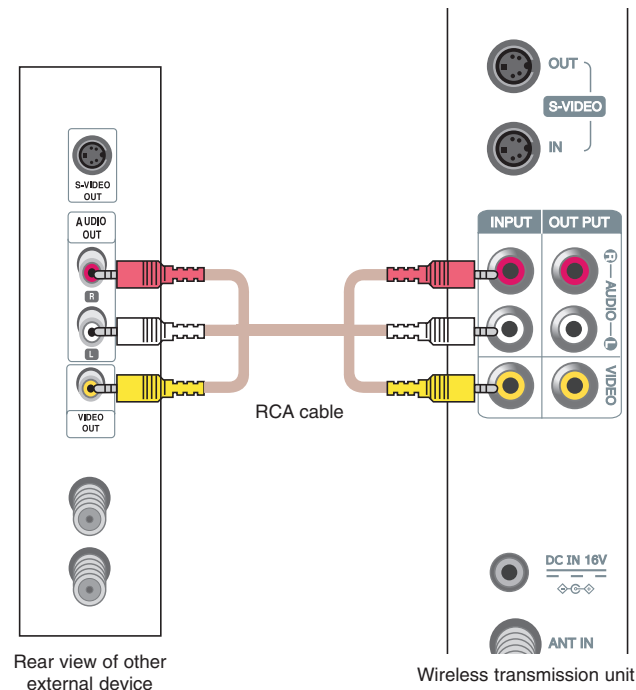

Necessary Connection Cables

- RCA cable



Note

- Do not attach the wireless transmission unit to the wall.
- If you find a mosaic pattern on the screen or the screen is not displayed properly due to poor network connection, set the front side of the wireless transmission unit to face towards the wireless TV.
- Screen display delay can occur, depending on the network connections status.

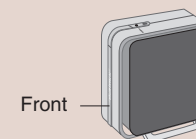

Wireless transmission unit

Watching the Wireless TV

Watching the wireless TV

Press the  **POWER** button on the remote control to watch the wireless TV.







1 **Channel display**

2 **Remaining battery amount display**

Press the  button on the remote control to display the remaining battery amount.

Watching the wireless TV in the Media Browser

- 1) Move to the Watching TV menu to watch TV in the Media Browser.
Move to the Watching TV menu using  and  buttons and press the  button.
- 2) Press the  **TV/MEDIA** button on the remote control to watch TV.





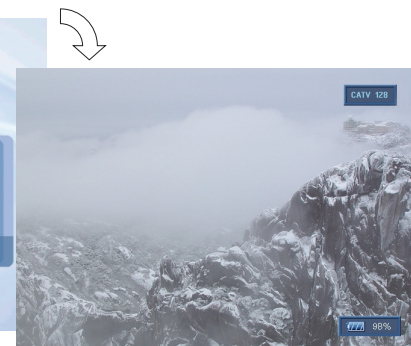

Media Browser Home screenshot.



TV screenshot



2 Remaining battery display

Image	Description
N/A	Battery is not inserted.
	Very low
	Approx. 20% left.
	Approx. 50% left.
	Approx. 80% left.
	Approx. 100%

Language Selection

On-screen Menus Language Selection

The menus can be shown on the screen in the selected language.

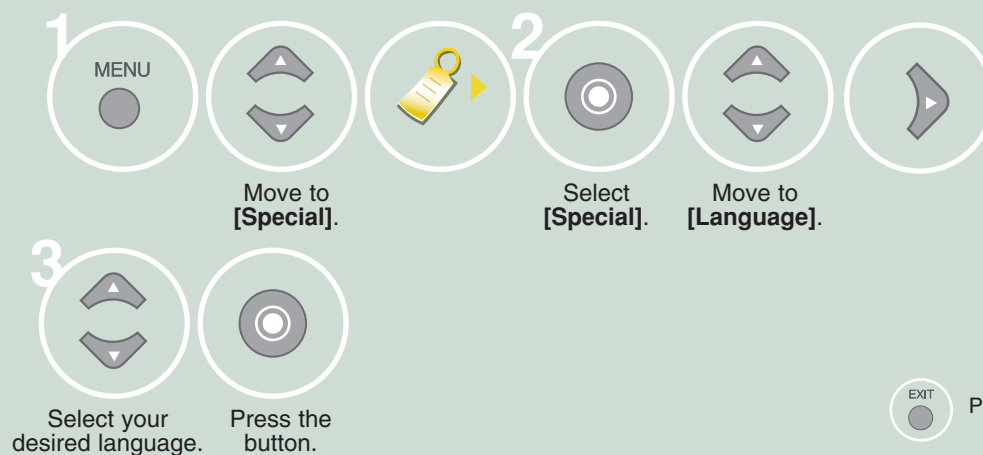
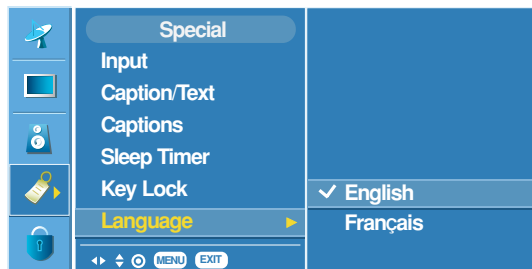

Press the **EXIT** button to hide the menu screen.



Press the **MENU** button to move to the previous menu screen.

Programming the Channels

Memorizing all broadcasting channels

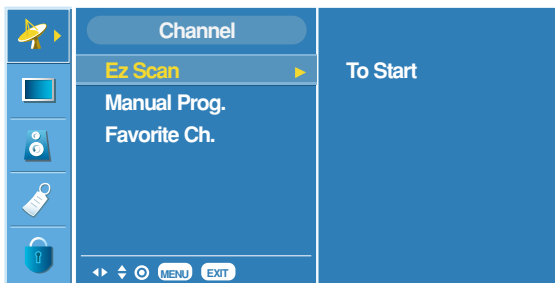

Memorizing or clearing the specific channels

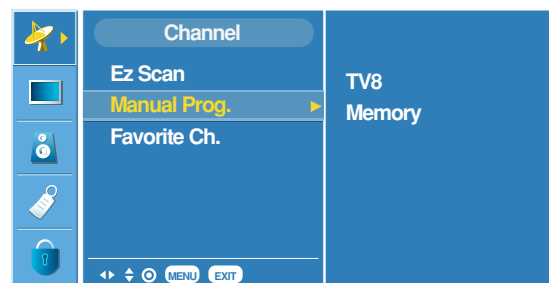

- If the CATV channel is duplicated with the public TV, the CATV channel will be selected. Each time you press the number button (0 ~ 9) for channel selection, CATV-public channel selection will be toggled.
- Press the  or **Exit** button while running [**Ez Scan**] to stop channel setting. Then, the channel(s) scanned at that time point will be memorized.

 Press the **EXIT** button to hide the menu screen.

 Press the **MENU** button to move to the previous menu screen.

Setting Favorite Channels

Watching the selected channel only

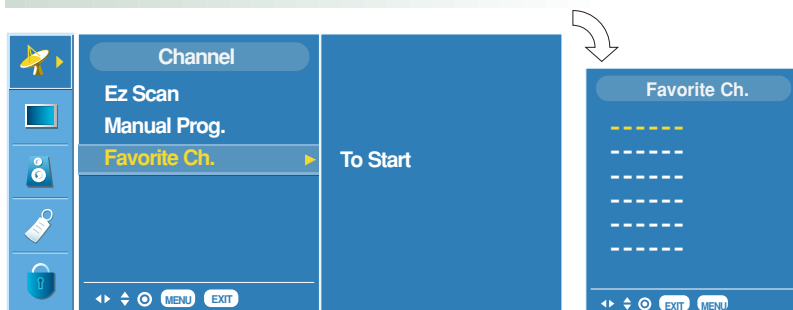

Use the **Favorite Ch.** function to create your favorite channel list.

- You can set up to 6 channels that you prefer.

If you want to watch your favorite channels only, press the **SURF** button.



- Each time you press the button, the selected favorite channel will be displayed sequentially.

* Set other channels using the same method.



Press the **EXIT** button to hide the menu screen.



Press the **MENU** button to move to the previous menu screen.

Adjusting the Picture

Adjusting the picture automatically

This function automatically adjusts the picture so that you can enjoy the optimal picture quality depending on the TV usage environment.

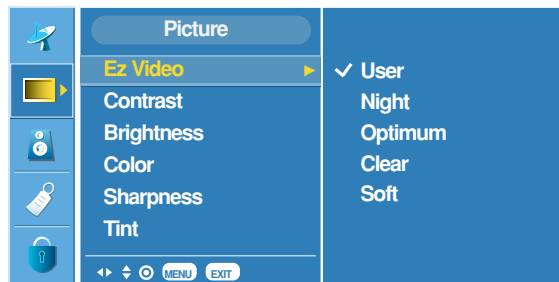

Adjusting contrast

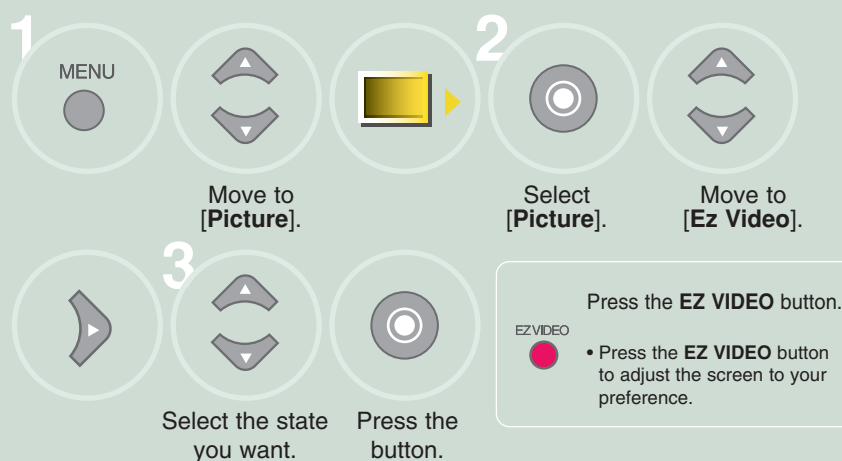
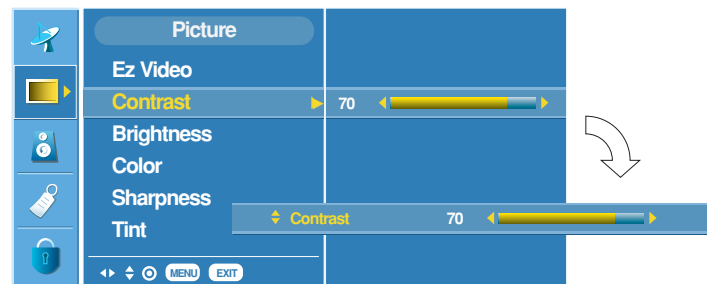

- **User:** Select this option to watch the TV with the picture setting that you or others have adjusted.
- **Night:** Suitable for dark area.
- **Optimum:** Most natural picture setting.
- **Clear:** Provides clear picture.
- **Soft:** Provides soft picture.

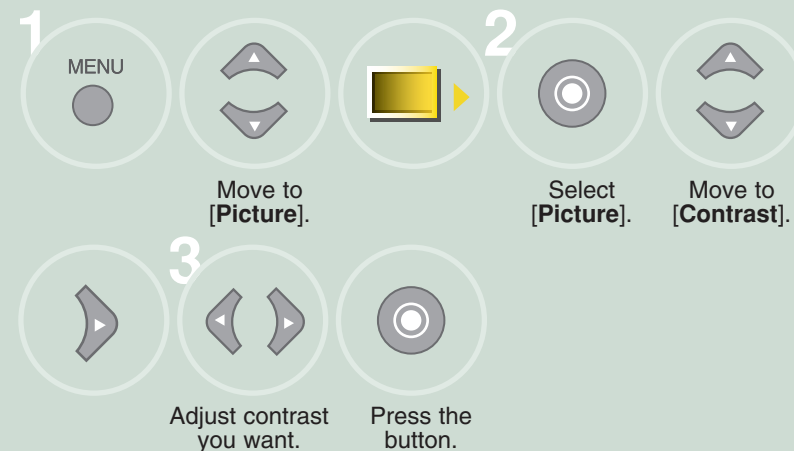

- **EXIT:** Press the **EXIT** button to hide the menu screen.
- **MENU:** Press the **MENU** button to move to the previous menu screen.

Adjusting the Picture

Adjusting brightness

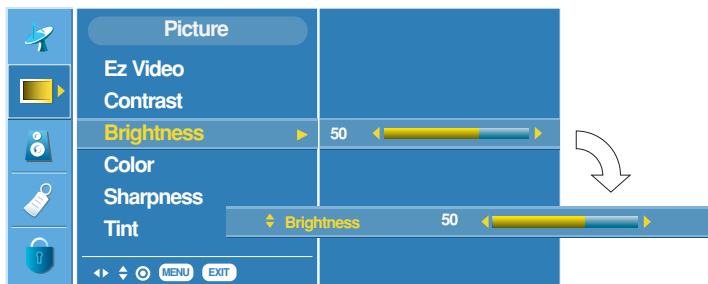

Adjusting depth of color

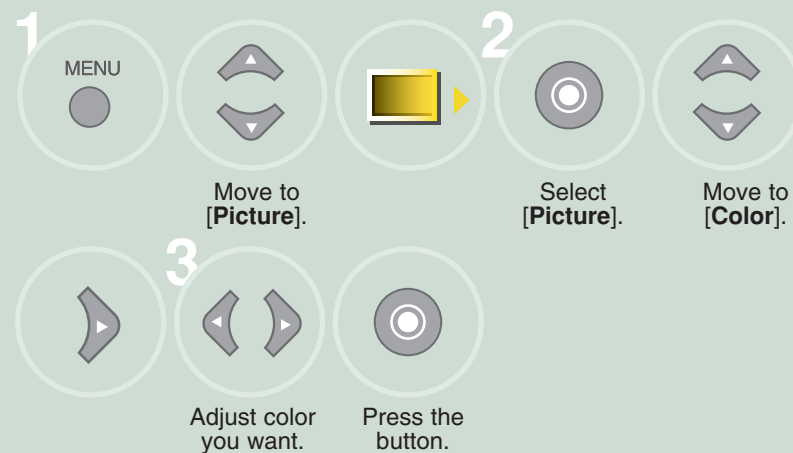
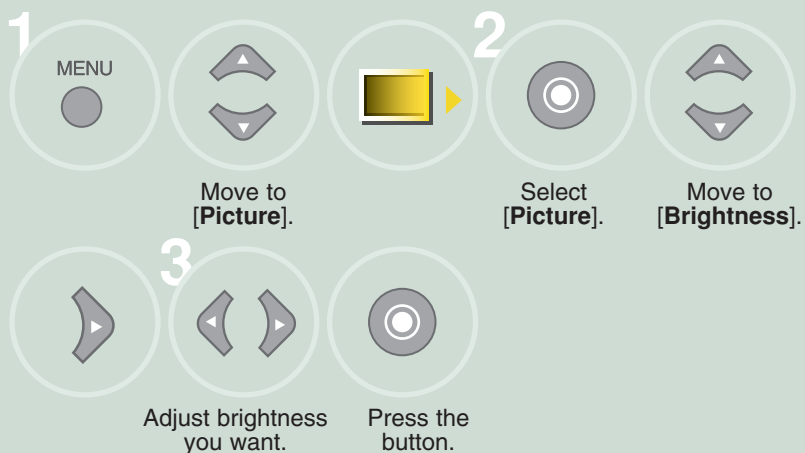
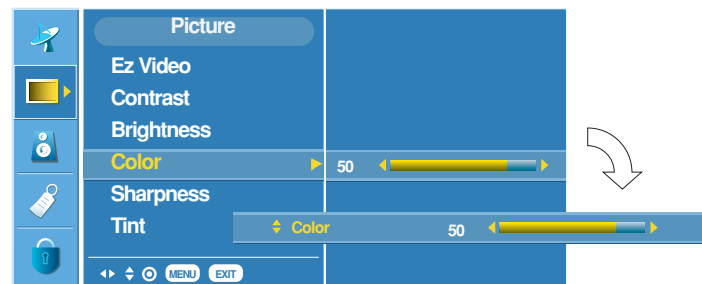

Press the **EXIT** button to hide the menu screen.

Press the **MENU** button to move to the previous menu screen.

Adjusting the Picture

Adjusting sharpness

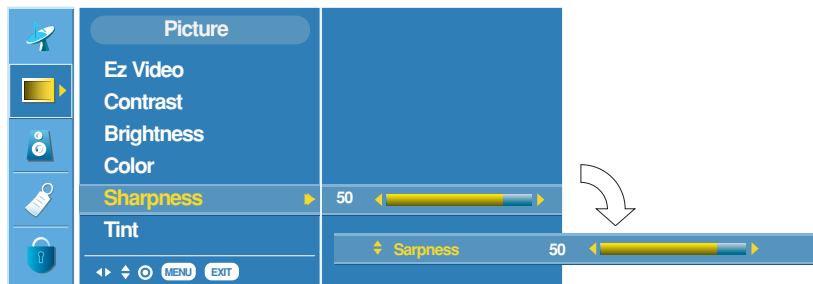

Adjusting tint

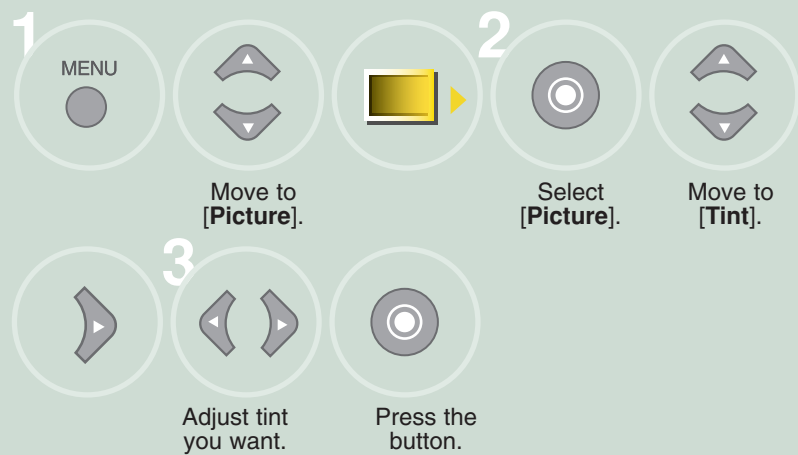
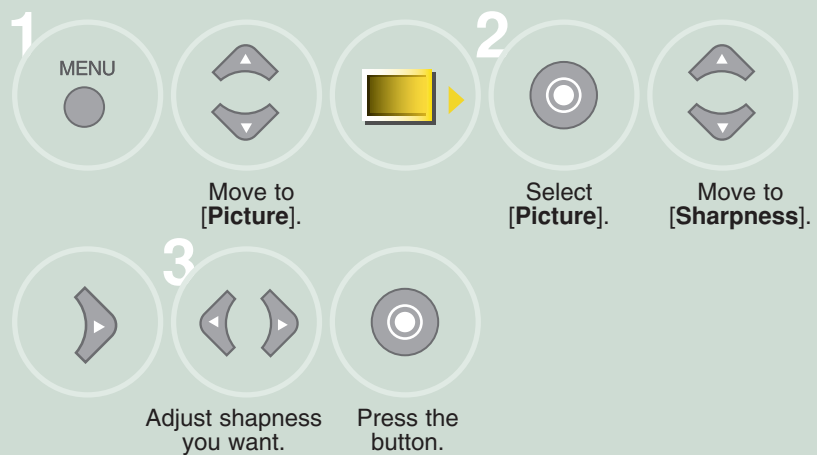
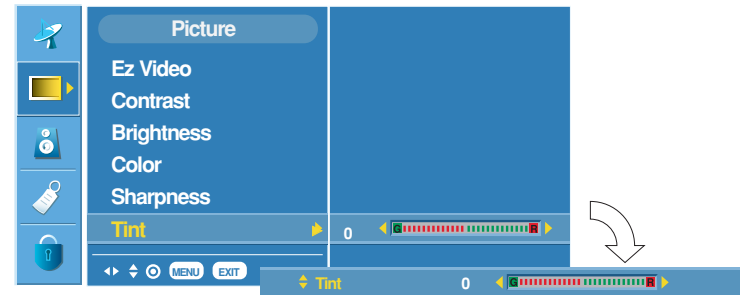

- Press the **EXIT** button to hide the menu screen.
- Press the **MENU** button to move to the previous menu screen.

Adjustment when
Using the Wireless TV

Adjusting Sound

Adjusting best sound automatically

This function automatically adjusts sound according to the type of the picture you're watching so that you can enjoy the best sound quality.

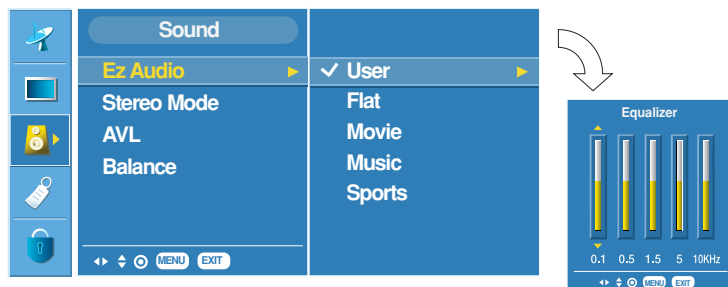

Using the SAP (Secondary Audio Program) function

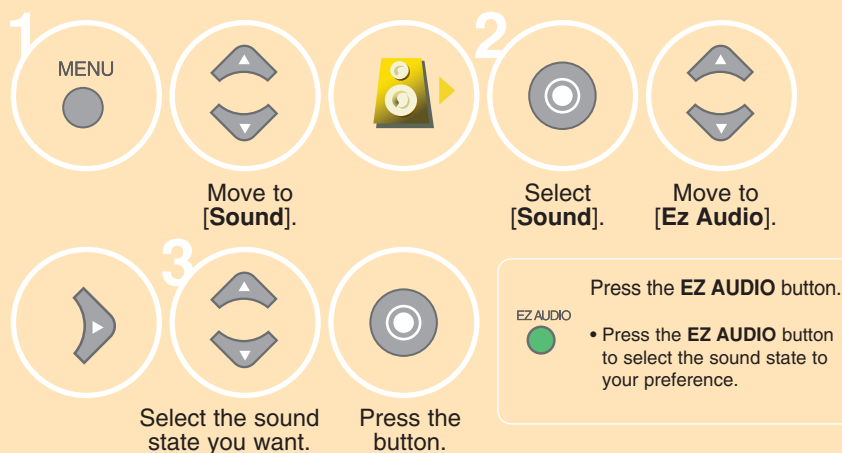
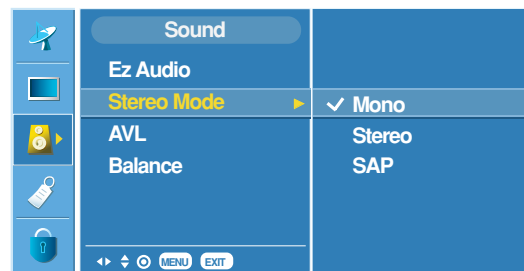

- **User:** Select this option to use the user-defined sound settings.
- **Flat:** Most natural sound settings.
- **Movie:** You can enjoy the magnificent sound.
- **Music:** You can enjoy the live original sound without change.
- **Sports:** Select this option when watching a sports program.

- The TV can receive MTS stereo programs and any SAP (Secondary Audio Program) that accompanies the stereo program, if the broadcaster transmits an additional sound signal as well as the original one.
- **Mono:** The primary language is heard from left and right speakers. Signal mode is mono.
- **Stereo:** The primary language is heard from left and right speakers. Signal mode is stereo.
- **SAP:** The secondary audio program is heard from left and right speakers.

Adjusting Sound

AVL (Auto Volume Leveler)

AVL maintains an equal volume level automatically even if the channel is changed.

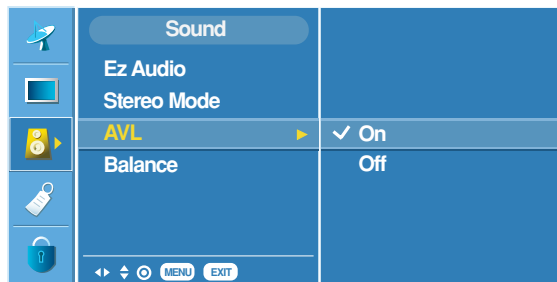

Adjusting sound balance

Adjust the sound balance you want.

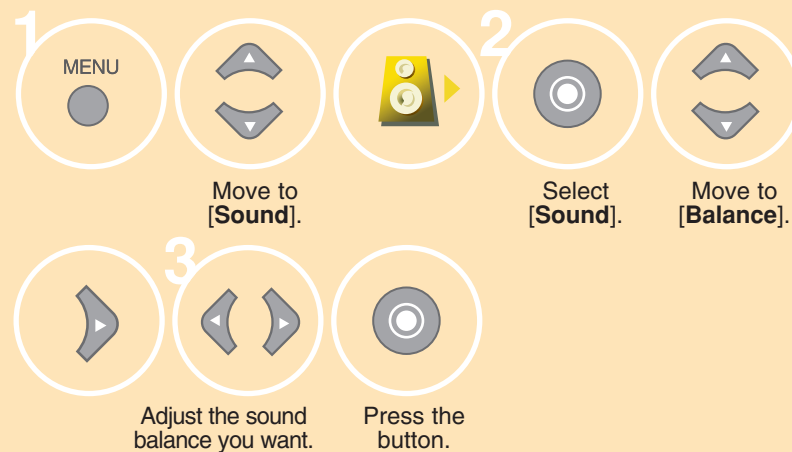
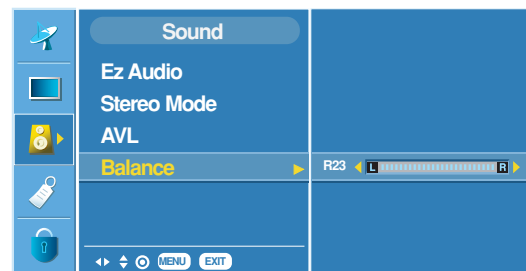

 Press the **EXIT** button to hide the menu screen.

 Press the **MENU** button to move to the previous menu screen.

Special Menu Options

Selecting the Input Signal

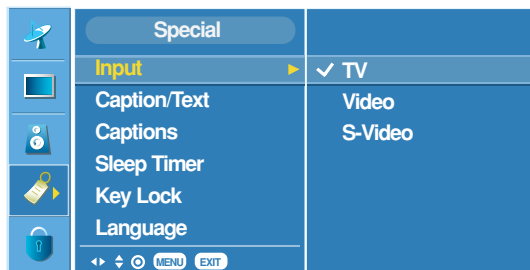

Watching the Program with Caption Text

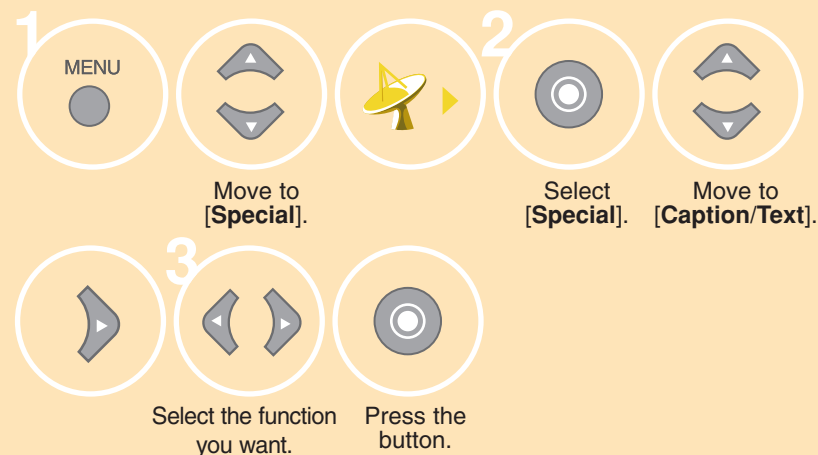
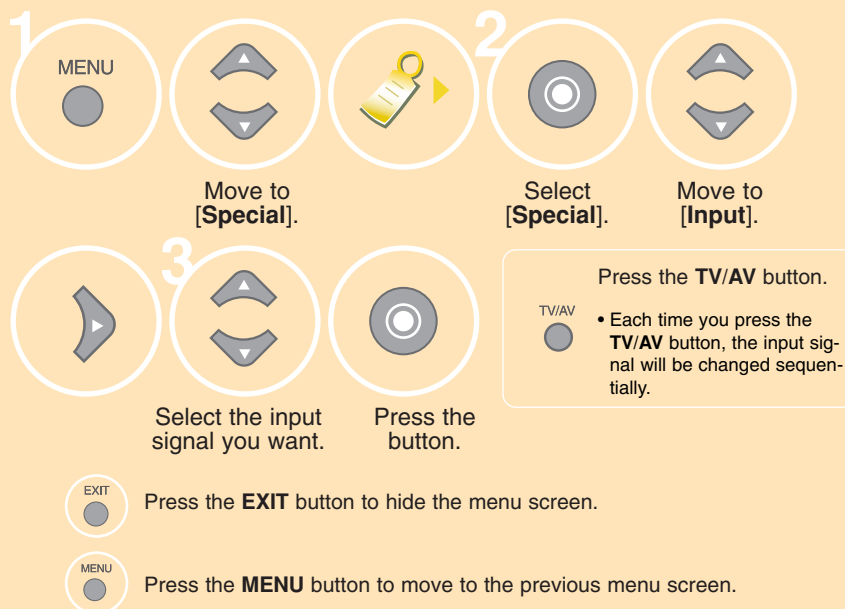
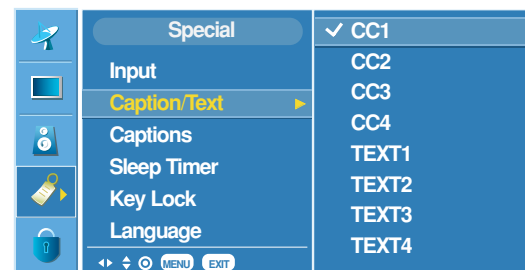

• CAPTION

The term for the words that scroll across the bottom of the TV screen; usually the audio portion of the program provided for the hearing impaired.

• TEXT

The term for the words that appear in a large black frame and almost cover the entire screen; usually messages provided by the broadcaster.

Special Menu Options

Setting the Captions

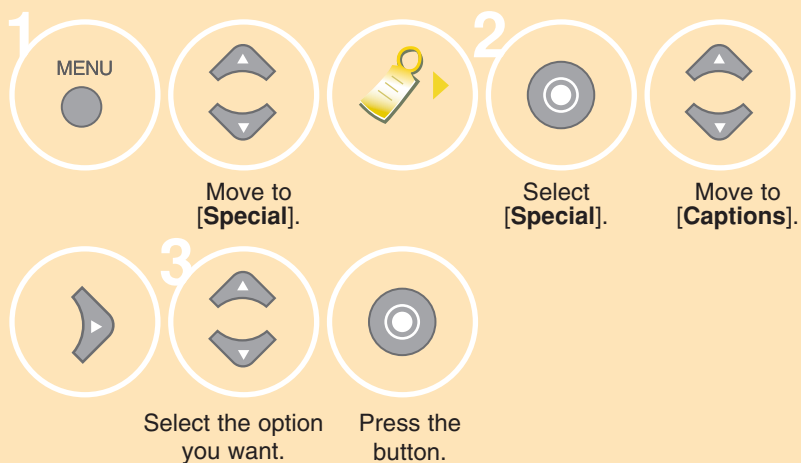
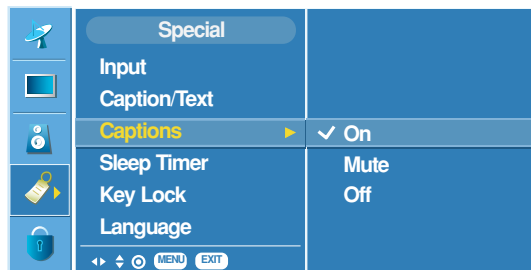

- Mute shows the selected captions option (if available on program) when the TV sound is muted.

Press the **CC** button



- Use the **CC** button repeatedly to select Caption Off, Mute or On.



Press the **EXIT** button to hide the menu screen.



Press the **MENU** button to move to the previous menu screen.

Special Menu Options

Closed Captions

Closed captioning is a process which converts the audio portion of a television program into written words which then appear as sub-titles on the television screen. Closed captions allow viewers to read the dialogue and narration of television programs.

Using Closed Captions

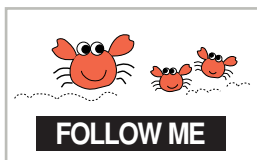

Captions are the subtitles of the dialogue and narration of television programs. For prerecorded programs, program dialogue can be arranged into captions in advance. It's possible to caption a live program by using a process called real-time captioning, which creates captions instantly.

Real-time captioning is normally done by professional reporters using a machine shorthand system and computer for translation into English. Captioning is an effective system for the hearing-impaired, and it can also aid in teaching language skills.

- The picture above shows a typical caption.

Caption Tips

- Not all TV broadcasts include closed caption signals.
- Sometimes TV stations broadcast four different caption signals on the same channel. By selecting From CC 1 to CC 4, you can choose which signal you view. CC 1 is usually the signal with the captions, while Another mode might show demonstration or programming information.
- Your TV might not receive caption signals normally in the following situations.

1. Poor reception conditions are encountered:



- **IGNITION:** Picture may flutter, drift, suffer from black spots, or horizontal streaking. Usually caused by interference from automobile ignition systems, neon lamps, electrical drills, and other electrical appliances.



- **GHOSTS:** Ghosts are caused when the TV signal splits and follows two paths. One is the direct path and the other is reflected off tall buildings, hills or other objects. Changing the direction or position of the antenna may improve reception.



- **SNOW:** If your receiver is located at the weak, fringe area of a TV signal, your picture may be marred by small dots. It may be necessary to install a special antenna to improve the picture.

2. An old, bad, or illegally recorded tape is being played.
3. Strong, random signals from a car or airplane interfere with the TV signal.
4. The signal from the antenna is weak.
5. The program wasn't captioned when it was produced, transmitted, or taped.

Special Menu Options

Menu can be different according to the selected input signal.

Setting the sleep timer

The TV will be automatically turned off after the setting period of time.

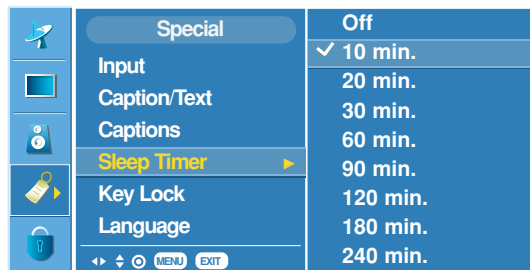

Setting the key lock

Disables the keypad on the TV.

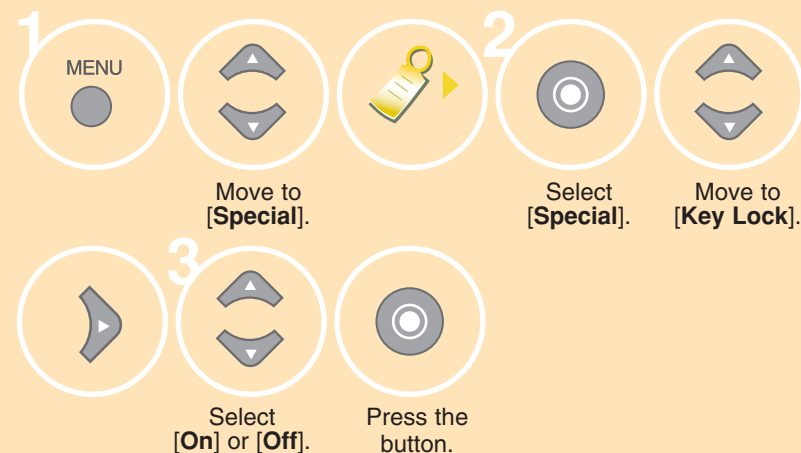
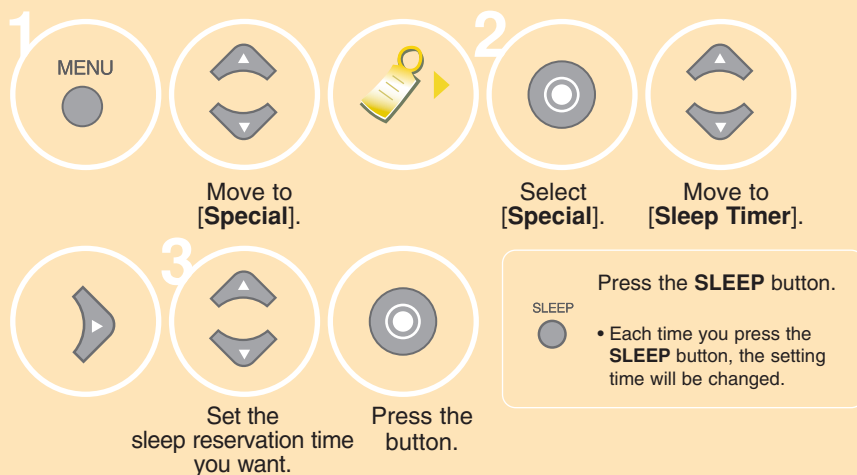
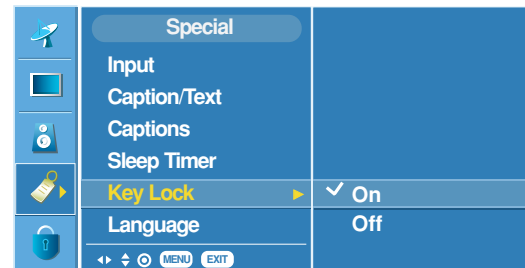

- Press the **EXIT** button to hide the menu screen.
- Press the **MENU** button to move to the previous menu screen.

- If you don't press the **SLEEP** button and wait for a while when the Sleep Timer is displayed on the screen, the Sleep Timer display will disappear and the sleep reservation time will be set.
- To check the remaining sleep reservation time after setting the Sleep Timer, press the **SLEEP** button once only.
- If you turn off the TV after setting the Sleep Timer, it will be cleared.
- This function will be disabled in the Media Browser.

Parental Lock Options

Setting the lock function

You can set the locking status for the program audience ratings received from the broadcasting service provider.

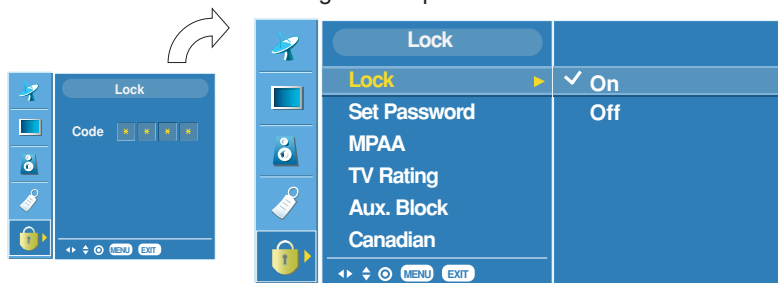

Changing the password setting

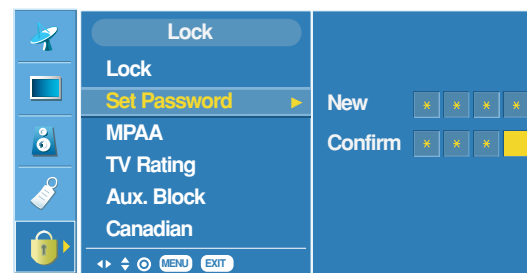

- If Lock is already set, enter the password requested.
- The TV is set with the initial password "0-0-0-0".

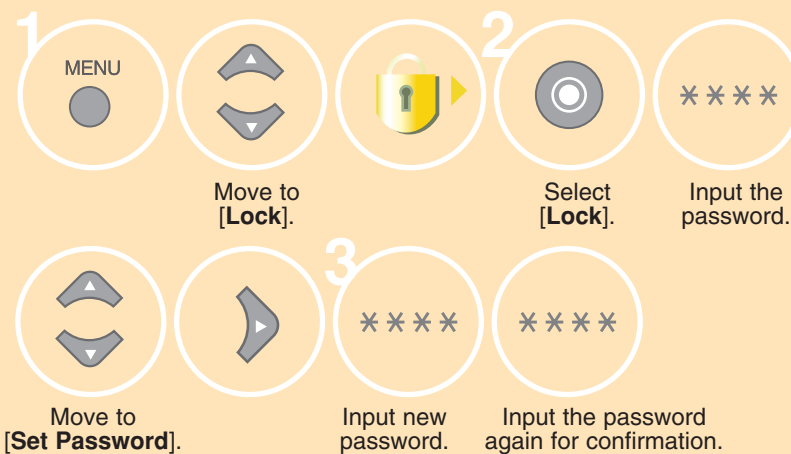

- **MPAA:** Select the ratings defined by the Motion Picture Association of America.
- **TV Rating**
 - **Age Block:** Select the age rating.
 - **Content Block:** Select the content rating
- **Aux. Block:** Set locking on the input source of the external devices connected to the TV set.
- **Canadian:** Select the ratings defined by the Canadian rating regulation.

Parental Lock Options

Parental Control can be used to block specific channels, ratings and other viewing sources.

The Parental Control Function (V-Chip) is used to block program viewing based on the ratings sent by the broadcast station. The default setting is to allow all programs to be viewed. Viewing can be blocked by the type of program and by the categories chosen to be blocked. It is also possible to block all program viewing for a time period. To use this function, the following must be set :

1. Ratings and categories to be blocked.
2. Set a password
3. Enable the lock

V-Chip rating and categories

Rating guidelines are provided by broadcast stations. Most television programs and television movies can be blocked by TV Rating and/or Individual Categories. Movies that have been shown at the theaters or direct-to-video movies use the Movie Rating System (MPAA) only.

For Movies previously shown in theaters :

Movie Ratings :

- Unblocked
- G and Above (general audience)
- PG and Above (parental guidance suggested)
- PG-13 and Above (13 years and older)
- R and above (restricted)
- NC-17 and Above (18 years and older)
- X (adult)

If you set PG-13 and Above: G and PG movies will be available , PG-13, R, NC-17 and X will be blocked.

For Television programs including made-for-TV movies:

General TV Ratings:

- Unblocked
- TV-G and Above (general audience) (individual categories do not apply)
- TV-PG and Above (parental guidance suggested)
- TV-14 and Above (14 years and older)
- TV-MA (mature audience)

Children TV Ratings:

- Unblocked
- TV-Y and Above (youth) (individual content categories do not apply)
- TV-Y7 (youth, 7 years and up)

Content Categories:

- Dialog - sexual dialogue (applies to TV-PG and Above, TV-14)
- Language - adult language (applies to TV-PG and Above)
- Sex scenes - sexual situations (applies to TV-PG and Above, TV-14 and Above, TV-MA)
- Violence (applies to TV-PG and Above, TV-14 and Above, TV-MA)
- F Violence - fantasy violence (applies only to TV-Y7)
- No Rating (blocks all viewing)

For Canadian English/French language rating system:

Canadian English language rating system:

- C & Above (Children)
- C8+ (8 years and older)
- G & Above (General programming. Suitable for all audiences.)
- PG & Above (Parental guidance suggested)
- 14+ (Viewer 14 years and older)
- 18+ (Adult programming)

Canadian French language rating system:

- G & Above (General)
- 8 ans+ (8 years and older)
- 13 ans+ (13 years and older)
- 16 ans+ (16 years and older)
- 18 ans+ (Adults only)

Using Media Browser

Setting the wireless network

There are **two methods** for setting the wireless network.

Setting method 1 If you use the wireless LAN card for the first time, take the steps described in the 'Setting method 1'.

Setting method 2 If you're familiar with wireless LAN card use, take the steps described in the 'Setting method 2'. (See page 50)

To use the Media Browser on your wireless TV, you will first need to configure your computer network and install the Media Library software. If your computer does not have a wireless LAN card, one will need to be purchased and installed.

You should purchase the wireless LAN card (or Access Point(AP)) separately **802.11g** adaptor (or 802.11g Access Point(AP)) that complies with Wi-Fi. You cannot use the **802.11a** wireless LAN card (or, **802.11a** Access Point(AP)) for this wireless TV. We recommend that you use the USB type adaptor that is easy to configure, or the wireless LAN card that runs in 802.11g only.

Setting method 1

1

Connect the power to the wireless TV.

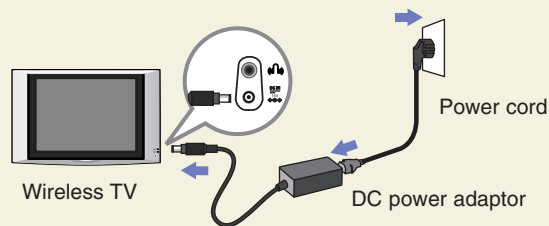

2

Turn on the wireless TV.

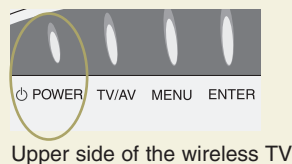

or



Switch to the '**Media Browser**' by pressing **TV/MEDIA** button.

'**SERVER FINDING**' or '**SEARCH FAILURE**' window will appear on the TV screen as shown in the figure. Do not click the **[OK]** on the screen but take the following steps.

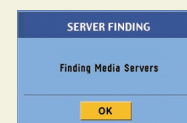

or



Using Media Browser

3 If the computer to install the Media Library is not equipped with the wireless LAN card (or, Access Point(AP)), install it first.

- * Ensure to read the User's Manual provided by the vendor of the wireless LAN card (or, Access Point(AP)) to learn about how to install the wireless LAN card.
- * For the wireless LAN card (or, Access Point(AP)) that supports both **802.11b** and **802.11g**, set the adaptor to run in **802.11g** only. <See the User's Manual of the wireless LAN card (or, Access Point(AP))> If you mix **11g** and **11b** when using the adaptor, link speed will drop.

When using the wireless LAN card

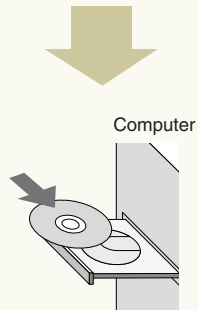
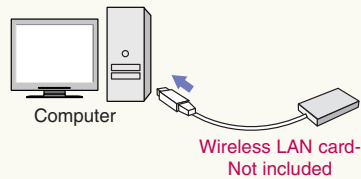

- Install the wireless LAN card driver files after installing it. Once the driver is successfully installed, go to step **4.** 'Setting the wireless network in the computer'.

When using the Access Point(AP)

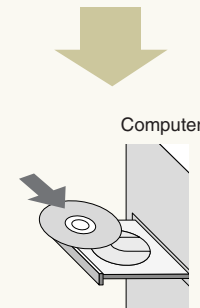
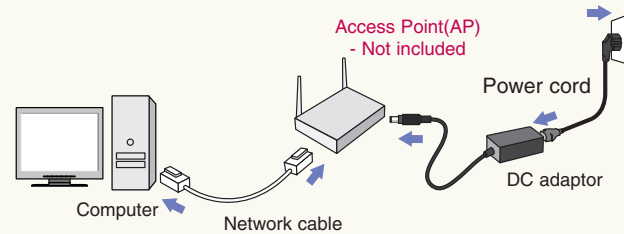

- Install the Access Point(AP) driver files after installing it. Once the driver is successfully installed, go to step **4.** 'Setting the wireless network in the computer'.

Using Media Browser

Setting the wireless network in the computer

4

* Set the computer SSID (Network name), WEP key, and connection mode as follows by referring to the User's Manual for the wireless LAN card (or, Access Point(AP)) that you purchased.

When using the wireless LAN card

1 SSID (network name)

* Set to "LGMB" (Case-sensitive)

2 Set WEP key as 'Not in Use'.

3 Set the Connection Mode as 'Networking between computers (Ad-hoc or peer-to-peer)'

4 Setting Internet protocol TCP/IP

Choose one of the following two setting methods.

■ 'Obtain an IP address automatically'

Performance can drop when connecting the computer to the wireless TV through wireless connection – up to 2 minutes delay.

■ 'Use the following IP address (manual)' (recommended)

IP address: 169.254.XXX.XXX (Input any number between 1 and 254 for XXX.) e.g., 169.254.45.200

Subnet mask: 255.255.0.0

Gateway: Do not input any IP.

When setting is complete, do not turn off the wireless TV but install the Media Library as described in step 5.

When using the Access Point(AP)

*Make sure to read the User's Manual of the Access Point(AP) provided by the vendor before setting the Access Point(AP).

1) Setting the Access Point(AP)

1 SSID (Network name)

- Use the existing SSID(network name) without change, or input new SSID(network name) (case-sensitive) to use. e.g., LGMEDIA

2 Set WEP key as 'Not in Use'.

3 Setting Internet protocol TCP/IP

- Set the Access Point(AP) IP address as 192.168.0.1 and subnet mask as 255.255.255.0.
- If Access Point(AP) provides the DHCP Server function, activate it. (recommended)

2) Setting the computer

- Connect the Access Point(AP) to the computer using the Ethernet cable.

1 Setting Internet protocol TCP/IP

Choose one of the following two setting methods.

• 'Obtain an IP address automatically'

If you have activated the DHCP Server function when setting the Access Point(AP), select the 'Obtain an IP address automatically' option.

• 'Use the following IP address (manual)' (recommended)

Set as follows if you have not activated the DHCP Server function when setting the Access Point(AP) or the Access Point(AP) does not provide it.
IP address: 192.168.XXX.XXX (Input any number between 2 and 254 for XXX.) e.g., 192.168.0.200

Subnet mask: 255.255.255.0

Gateway: 192.168.0.1.

To be continued on the next page.

Using Media Browser

Set only when you use the **Access Point(AP)**

Take the following setting steps when Access Point(AP) setting is complete.



OR



Press the [OK] in the 'SERVER FINDING' or 'SEARCH FAILURE' window on the TV screen, using the remote control button.

The setting screen will appear.



* Your wireless TV IP Address may be different from the one described in this manual.

Move to 'Select Network' field using the and button on the remote control.

Find the **SSID(network name)** you have set in the computer using the and button on the remote control, and press the button. e.g., LGMEDIA

- If you select the 'Obtain an IP address automatically' option, select 'Automatic'. If you select automatic network setting, the IP Address, Subnet mask and Gateway will not appear in the wireless TV. (No setting is required.)
- If you select the 'Use the following IP address' option, select 'Manual' and set the fourth column of the IP Address different from the Access Point(AP) and the computer. If you set the same address, it will not run.

e.g., Wireless TV: 192.198.0.110, Access Point: 192.168.0.1, Computer: 192.168.0.200
Subnet Mask: Set the same value with the Access Point(AP). e.g., 255. 255. 255. 0
Gateway: Input the IP address set in the Access Point(AP). e.g., 192.168.0.1

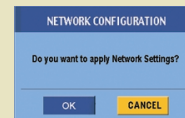

Press the button on the remote control.
When the Network Setting Confirmation window appears, press the button on the remote control.



When the Find Media Server window appears as shown left, insert the Media Library Installation CD into the computer.

Using Media Browser

At your computer : Installing the 'Media Library' Server in you computer

Once the 'Media Library' program is installed in your computer, you can view the picture or play back music or movie by connecting the wireless TV to the Media Browser. You should install the program first to use the Media Browser in the wireless TV.

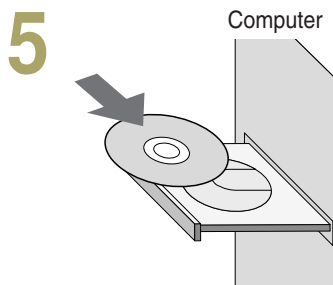

- Insert the installation CD into the CD-ROM drive. Wait until the installation message appears.

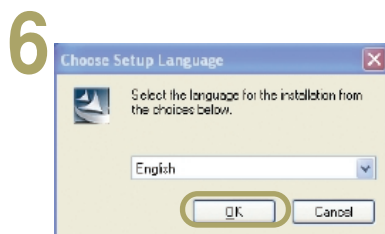

- When the Install Media Library window appears, select the language (English/Korean) and click the [OK].
- If the installation window does not appear automatically, double click the 'setup.exe' file in the CD manually.

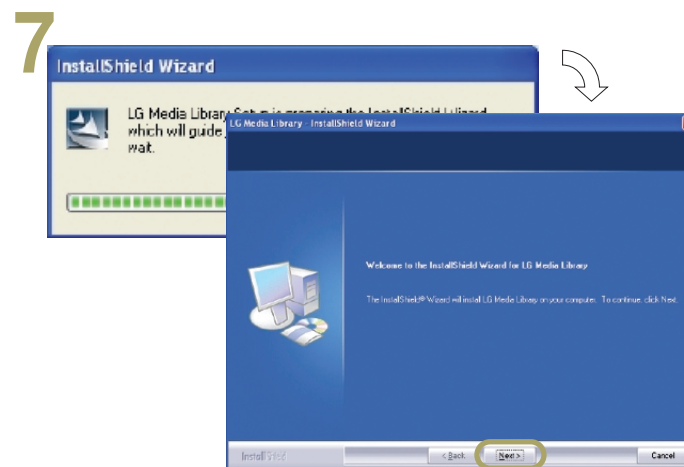

- When installation is ready to proceed, click the [Next] button.

Minimum PC requirement for installation

OS	CPU	RAM	Hard Disk	USB
Windows 98 Windows 98SE Windows ME Windows 2000 Windows XP	Pentium III 600MHz or faster	128Mb or more	1Gb or more	USB 2.0 support

* Wireless LAN card should have the Access Point(AP) or NIC (Network Interface Card) that supports 802.11g.

* Wireless LAN card should comply with Wi-Fi.

Recommended PC specification

OS	CPU	RAM	Hard Disk	USB
Windows XP	Pentium IV 1.5GHz or faster	128Mb or more	40Gb or more	USB 2.0 support

* Wireless LAN card should have the Access Point(AP) or NIC (Network Interface Card) that supports 802.11g.

* Wireless LAN card should comply with Wi-Fi.

Using Media Browser

8

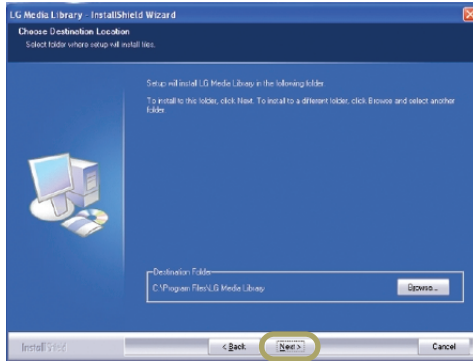

- Create a folder to install the Media Library.
- Click the **[Next]** to create the '**LG Media Library**' folder under the 'C:\Program Files' folder automatically.

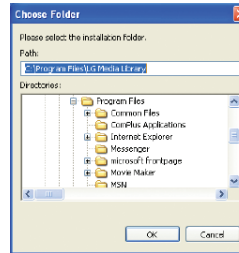

- If you want to install the program at other folder, click the **[Browse]** and specify the folder.

9

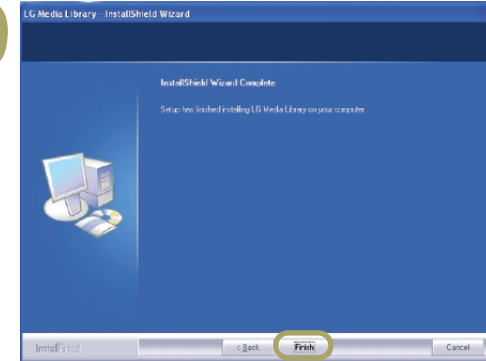

- Installation of the Media Library is complete.
- Click the **[Finish]** to complete installation.

10

- When the question window appears, click the **[Yes]** to run the Media Library.

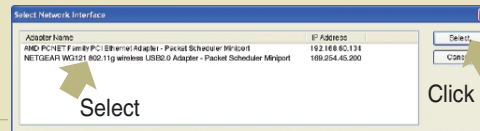
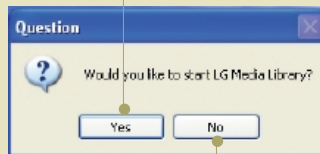

- When you run the Media Library, the Select Network Interface window will appear. Select the wireless network adaptor you have installed and click the **[Select]**.
When the '**Media Library Manager**' window appears, share the folder you want. (See page 53)
When the program is successfully installed, the initial screen of '**Home Media**' will appear on the wireless TV.

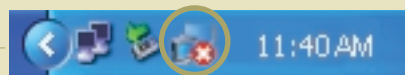

- The program icon will appear on the Windows Task Bar.

Deleting the Media Library program

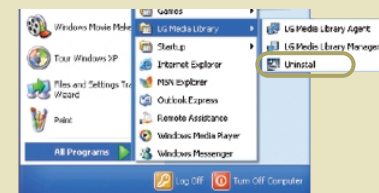

1. Select Start > All Programs > LG Media Library > Uninstall to uninstall the Media Library.
* When system rebooting selection message appears, select the option you want and click the **[Finish]**.
2. You can also delete the Media Library program by selecting My Computer > Control Panel > All or Remove Programs.

Using Media Browser

11

When using the **Wireless LAN card**

- When the program is successfully installed, the initial screen of **'Home Media'** will appear on the wireless TV.



When using the **Access Point (AP)**

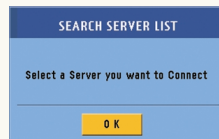



Press the  button on the remote control when the **'SEARCH SERVER LIST'** window appears on the TV screen.



The IP address of the computer installed with the Media Browser will be displayed on the Select Media Server window.

If it matches with the computer's IP Address, press the  button.

If not, find the matching IP Address using the  and  button on the remote control and, press the  button.



- When the program is successfully installed as described above, the initial screen of **'Home Media'** will appear on the wireless TV.

Using Media Browser

Setting method 2

If you're familiar with wireless LAN card setting, configure the wireless network of the computer and the wireless TV by referring to the following section.

1

Connect the power of the wireless TV.

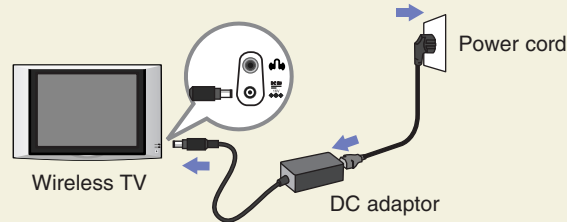

2

Turn on the wireless TV.

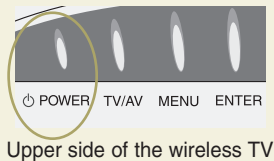

or



Switch to the 'Media Browser' pressing TV/MEDIA button.



The 'SERVER FINDING' or 'SEARCH FAILURE' window will appear on the TV screen as shown in the figure. Press the [OK] using the  remote control button.

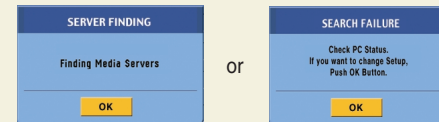

3





The Setting window will appear. The setting details are as follows.

1. SSID (network name): LGMEDIA
2. WEP key: Not In Use
3. Operation mode: ad-hoc
4. Internet Protocol TCP/IP: Obtain an IP address automatically

To change the settings, take the following steps.

(For your reference, the computer should have been turned on, and the wireless LAN card(or, the Access Point(AP)) also should have been configured in advance in the computer.)

Move to 'Select Network' using the  and  button on the remote control.

Select the SSID (network name) set in the computer or the Access Point(AP) using the  and  button on the remote control.

Press the  button on the remote control when setting is complete.

Using Media Browser

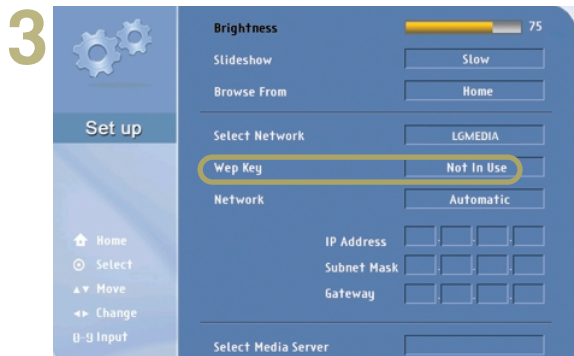

Move to WEP key using the and key on the remote control.

If you have set the WEP key in the computer (or, the Access Point(AP)), you should set the same WEP key in the wireless TV.

(If not, you don't have to set the WEP key in the wireless TV.)

Select '64 bits' if the WEP key is 5 or 10 digit long. Or, select '128 bits' if it is 13 or 26 digits. Then, press the button on the remote control.

Input the WEP key when the virtual keyboard appears.

Press the **[OK]** on the virtual keyboard using the remote control button when setting is completed. For your reference, WEP key setting can slow down performance.

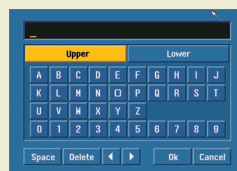
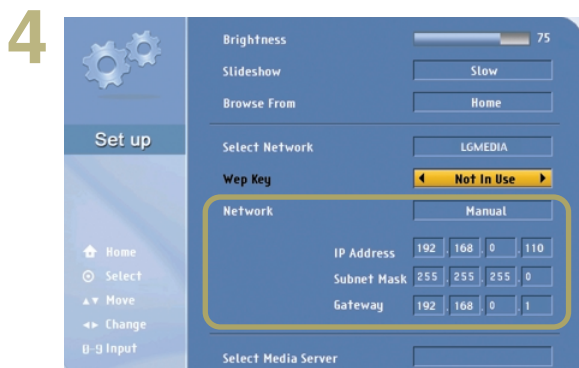

Virtual keyboard

Input the number or the character you want by pressing the buttons on the remote control.

Move to the Network section using the and button on the remote control.

Select whether you want to set the IP Address automatically or manually.

Select '**Automatic**' if you select the '**Obtain an IP address automatically**' option for IP Address setting in the computer. Otherwise (manual setting), input IP Address, Subnet Mask and Gateway using the number buttons on the remote control.

Set the fourth column of the IP Address different from the computer. If you set the same address, it will not run e.g., Computer: 192.168.0.200, wireless TV: 192.168.0.110

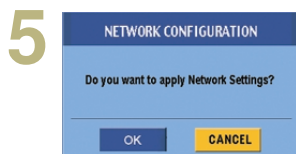



Press the button on the remote control.

Press the button on the remote control when the Network Setting Confirmation Window appears.

Using Media Browser

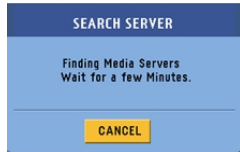
6



When network setting is complete, the 'SEARCH SERVER' window will appear as shown left. Press the  button on the remote control to cancel. Do not then configure other items but install the Media Library in the computer. (See page 47.)

7

When Media Library installation is complete, run 'LG Media Library Agent'. Then, the 'Select Network Interface' window will appear. Specify the wireless LAN card adaptor you have installed.



LG Media Library Agent

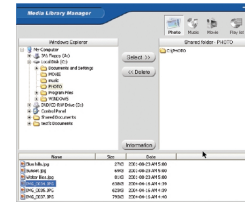





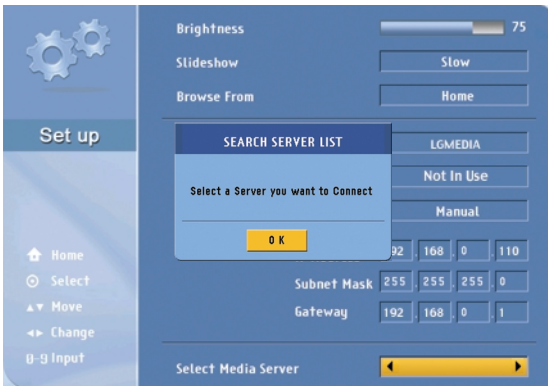

- Run LG Media Library Agent.

- Specify the wireless LAN card (or, Access Point(AP)) and click the [Select].

- Share the folder to share when the 'Media Library Manager' window appear. (See next page)

8



The 'SEARCH SERVER LIST' window will appear if the Media Browser is successfully installed. Press the  button. Then, the IP address of the computer installed with the Media Browser will be displayed. If it matches with the computer's IP address, press the  button. If not, find the matching IP address using the  and  button on the remote control and, press the  button.

The Home screen of the Media Browser will appear and setting will be completed.



Note

If the IP Address of the computer does not appear in the Select Media Server window, the wireless LAN card (or, Access Point(AP)) setting must be incorrect or the Media Library is not installed properly. In this case, check whether the wireless (or, Access Point(AP)) setting of the computer matches with that of the wireless TV, or the Media Library is properly installed.

Using Media Browser

Using Media Library Manager

Once the **Media Library** program is installed in your computer, you can view the picture or play back music or movie by connecting the wireless TV to the Media Browser. Pictures, music files and movie files should have been shared using the Media Library Manager to view the picture or play back music or movie stored in the computer.

At your computer

1



LG Media Library Agent

- Double click the Media Library icon on the Desktop window to start the program.

2



- Once the program is started, the Media Library icon will be activated in the Windows Task Bar. Click with the right mouse button to start the Media Library Manager.

To start with a different method,

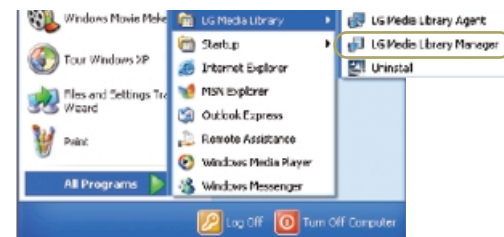

1. Select Start > All Programs > LG Media Library > LG Media Library Manager to use the Media Library Manager program.
2. Click the right mouse button to use the Media Library Manager.

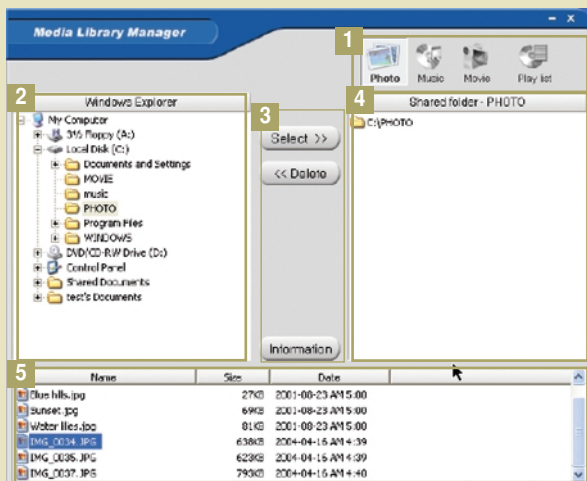

1 Menu selection button

Picture: Manages picture file share folder.

Music: Manages music file share folder.

Movie: Manages movie file share folder.

Playlist: Manages the playlist. (See page 57)

2 Windows Explorer

You can find the folder to add to the Shared folder.

You cannot move the local disc drive to the Shared folder.

e.g., C or D drive.

3 Select/Delete/Information button

Select: Adds the selected folder to the Shared folder.

Delete: Deletes the selected folder from the Shared folder.

Information: Shows the property information on the selected folder or file.

4 Shared folder

You can check and use the folder added in the Shared folder in the wireless TV.

5 File view

You can check the file(s) in the selected folder.

Viewing Pictures





At the wireless TV : Viewing Pictures

You can view the images or the pictures in the folder shared by the Media Server. (See page 53 – Sharing files in the Media Server)



Viewings the images in the folder



The wireless TV supports the following picture file formats.
Supported format : *.jpeg, *.jpg

- 1 **Moving up** Select the  icon using the movement buttons on the remote control to move to the upper folder.
- 2 **Preview** You can preview the pictures in the folder. The  image will appear if the picture does not contain the preview information.
- 3 **Page Up /Down** You can move up/down the list by page using the  **CH/PAGE** button on the remote control.
- 4 **Arrange List** You can arrange the name of the folder or picture files by ascending/descending order using the  **EZ VIDEO** button on the remote control.
- 5 **Back to 'Home Media'** You can move to the home screen using the  **HOME** button on the remote control.





Movement buttons

Viewing pictures

- 1 Select the image to view using the movement buttons on the remote control.
Selection button: 
- 2 Press the  **STOP** button or  **EXIT** button to move back to the picture list.

Viewing pictures while listening to the music

- 1 Play back the music file. (See page 56.)
- 2 Move to the **'Picture'** menu and view the picture after returning to the **'Home Media'** screen.
(You can adjust the sound volume at any menu – **'Music'** menu, **'Home Media'** or **'Picture'** menu, using the  **VOL** button.)
- 3 To stop music playback, return to the **'Home Media'** and move to the **'Music'** menu. Press the  **STOP** button to stop music playback.



Note

File arrangement will be disabled during music playback.

Viewing Pictures



- 1 **View page** You can display current page as well as all pages. (Current page/All pages)
- 2 **View file name** You can check the file name of the picture.
- 3 **Rotate** You can rotate the selected picture for viewing.
 - button on the remote control: Rotate the left picture.
 - button on the remote control: Rotate the right picture.
- 4 **View previous / next picture** You can display the picture previous/next to the current picture.
 - Remote Control button: Displays the picture previous to the currently selected picture.
 - Remote Control button: Displays the picture next to the currently selected picture.
- 5 **Stop** Use **STOP** or **EXIT** button to return to the View Picture List screen.
- 6 **Hide** Hides the status bar at the bottom. Select the button repetitively to show the status bar again.

Viewing the slide show

- 1 Select the image to view using the **MARK** button.
 - * To select consecutive files at a time.



Click at the beginning of the selected pictures!

Click at the end of the selected pictures!

Selection button: Selection cancel button:

- 2 Press the Start Slide Show button.
 - * If you press this button when no picture is selected, all files will be included in a slide show.

- 3 The selected files will be displayed as a slide show with the preset speed. (Use the Setting menu to change slide show speed! [See page 61.](#))
- 4 Press the **STOP** or **EXIT** button to stop playing a slide show.
 - * If you don't press the **STOP** button, the slide show will continue repeatedly.

Playing Musics

At the wireless TV : Playing musics

You can play back the music files in the folder shared by the Media Server. (See page 53 – Sharing files in the Media Server)

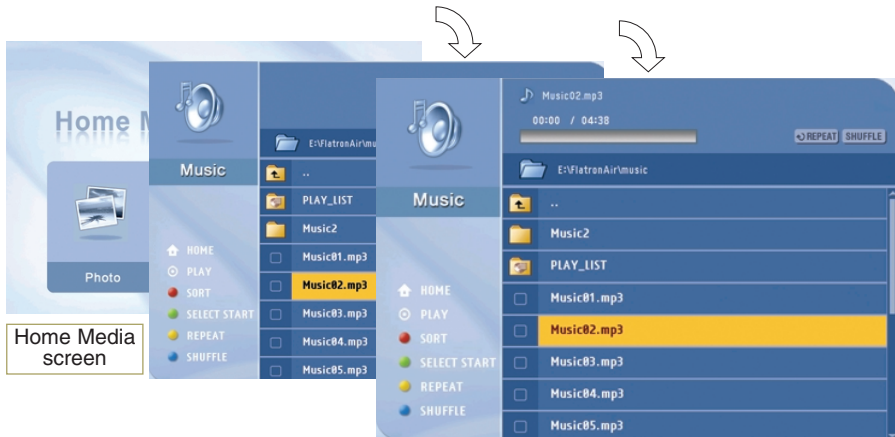

Playing back the music files in the folder

The wireless TV supports the following music file formats.
Supported format : MPEG1 Layer I, II, III (*.mpa, *.mp3)

- 1 Moving up** Select the icon using the movement buttons on the remote control to move to the upper folder.
- 2 Page Up /Down** You can move up/down the list by page using the button on the remote control.
- 3 Arrange List** You can arrange the name of the folder or picture files by ascending/descending order using the **EZ VIDEO** button on the remote control.
- 4 Back to 'Home Media'** You can move to the home screen using the **HOME** button on the remote control.



Playing musics

Select the music file to play back and press the button or **PLAY** button.

* Use the **MARK** button to select multiple files.

* Selecting several consecutive files at a time:

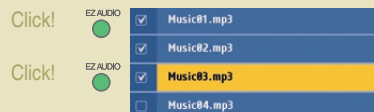

Selection button: Selection cancel button:

Playing back previous/next music file

Press the button to play back the previous music file, or the button to play back the next one.

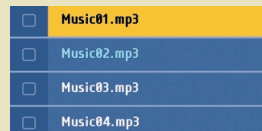

* The title color will be changed to light blue.



Note

File arrangement and **MARK** button will be disabled during music playback.

If you press the **HOME** button during playback, the selected music file will be played back instead.

You cannot move from the Home screen to the Setting screen during music playback.

Playing Music

Playing music using a playlist

You can create a playlist that contains your favorite music and use it on the wireless TV. (See next page)

At your computer

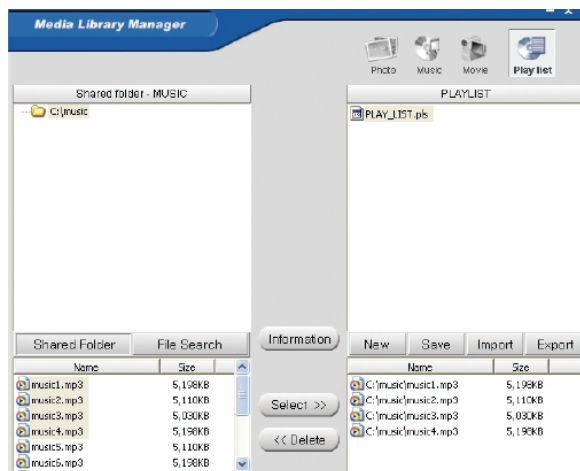

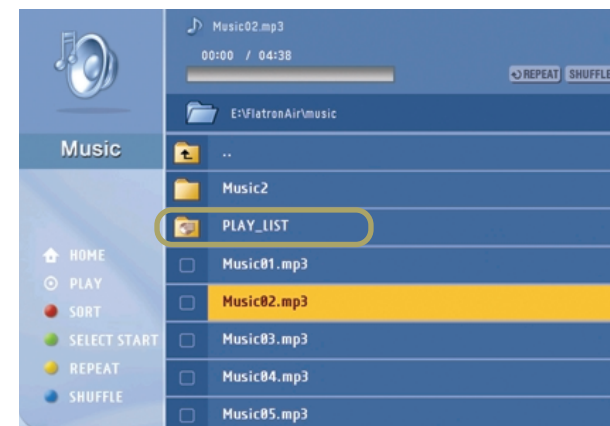

At the wireless TV



Stop/Pause

STOP: Press the  **STOP** button to stop playback of the current music file.

PAUSE: Press the  **PAUSE** button to temporarily stop music playback. To resume playback, press the  **PLAY** button.

Repeat/Clear

Press the  **AUDIO** button to play back several music files in the playlist or selected file repetitively.

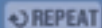
 **For repeated playback**

Random/Clear

Press the  button to play back the music files randomly.

 **For random playback**

Playing music

At computer : Creating a playlist

You can create a playlist that contains your favorite music and use it on the wireless TV. (See next page)

1



Select the **[Playlist]** icon.

2

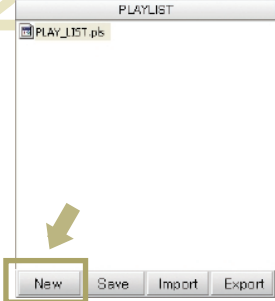

Click the **[New]** button in the Playlist window. A new playlist will be created.

- You must not omit the file extension (*.pls) when naming a playlist file.
- File extensions other than the specified one (*.pls) are not supported.

3

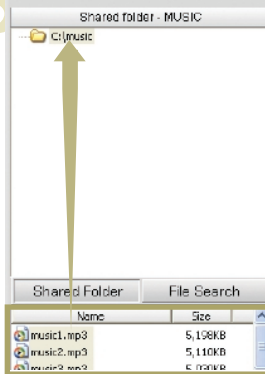

Select a folder in the Shared folder. Then, the music file list will be displayed at the bottom section. (No folder will appear if no folder is shared in the Music menu.)

Name	Size
music1.mp3	5,108KB
music2.mp3	5,110KB
music3.mp3	5,108KB

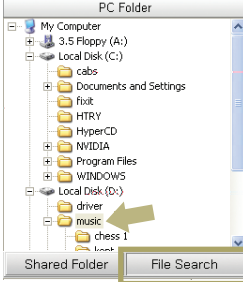

If the folder is not shared, click the **[File Search]** button and select the folder to share.

*** You can add the music files in the Shared folder only to the playlist.**

4

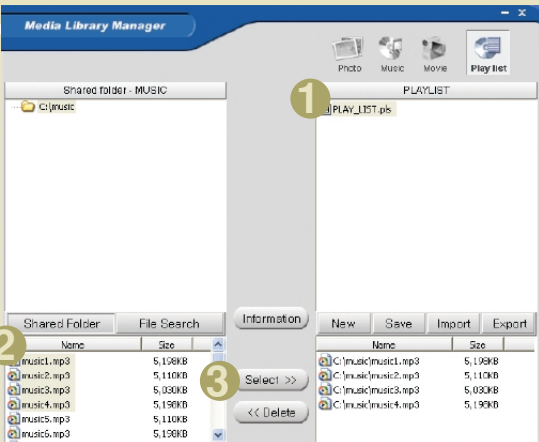

1. Select a **[PLAYLIST]**.
2. Select the music file to play back.
3. Click the **[Select]** button.

5

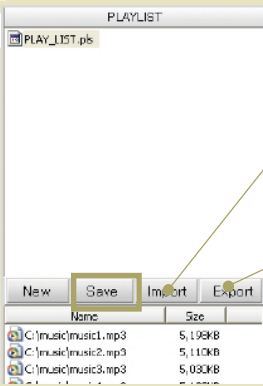

You can add the contents of the selected playlist to the currently edited playlist.

You can save the selected list in a playlist as a different file name.

The music file is added to the playlist. Click the **[Save]** button to save it.

(The file will be saved in My Computer -> C: -> Program Files -> LG Media Library -> Playlist by default.)

Playing Movies

At the wireless TV : Playing Movies

You can play back the video files in the folder shared by the Media Server. (See page 53 – Sharing files in the Media Server)

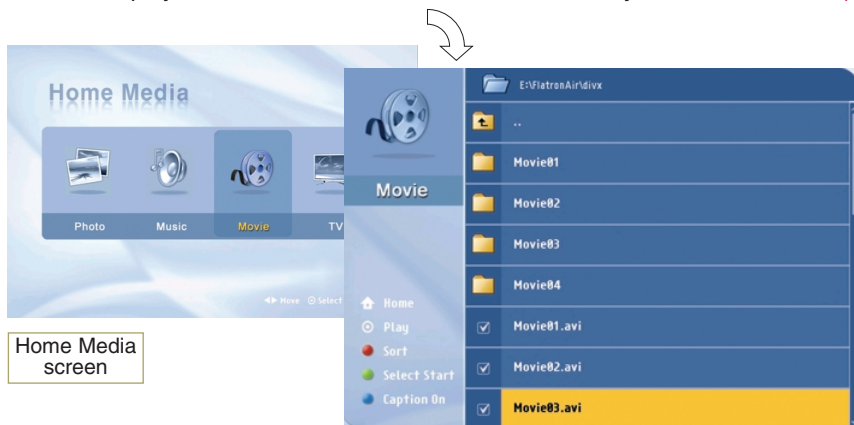







Home Media screen

View movie list



Supported format: MPEG-1 VCD, MPEG-2 (SD class), WMV9 (SD class), AVI.

* For more details, see the next page.

- Moving up**
Select the  icon using the movement buttons on the remote control to move to the upper folder.
- Page Up/Down**
You can move up/down the list by page using the  **CH/PAGE** button on the remote control.
- Arrange List**
You can arrange the name of the folder or movie files by ascending/descending order using the  **EZ VIDEO** button on the remote control.
- Back to 'Home Media'**
You can move to the home screen using the  **HOME** button on the remote control.
- Caption setting**
You can change the caption/text setting in the movie list screen using the  button on the remote control. Press the  button on the remote control to hide/show (toggle) the caption/text while playing back the movie file.





Playing back the movie

- Select the movie file to play back and press the  button or **PLAY**  button.

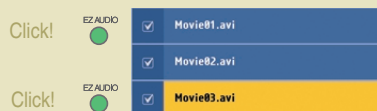
- * Use the  **MARK** button to select multiple files.
- * Selecting several consecutive files at a time:



Selection button:  Selection cancel button: 

- Press the  **STOP** button to move to the View Movie List window during playback.

- * When playback is finished, the View Movie List window will be automatically displayed.

* If you exit to the Home screen and return while playing back the movie file or playback is stopped.

If you select the movie file that was being played, the 'WHERE TO PLAY' window will appear.
(Some format does not display this window.)

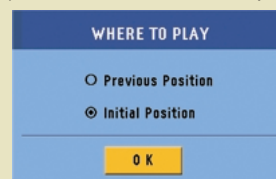

Previous Position: Resumes playback from the interrupted position.

Initial Position: Starts from the beginning.

Download from Www.Somanuals.com. All Manuals Search And Download.



Note

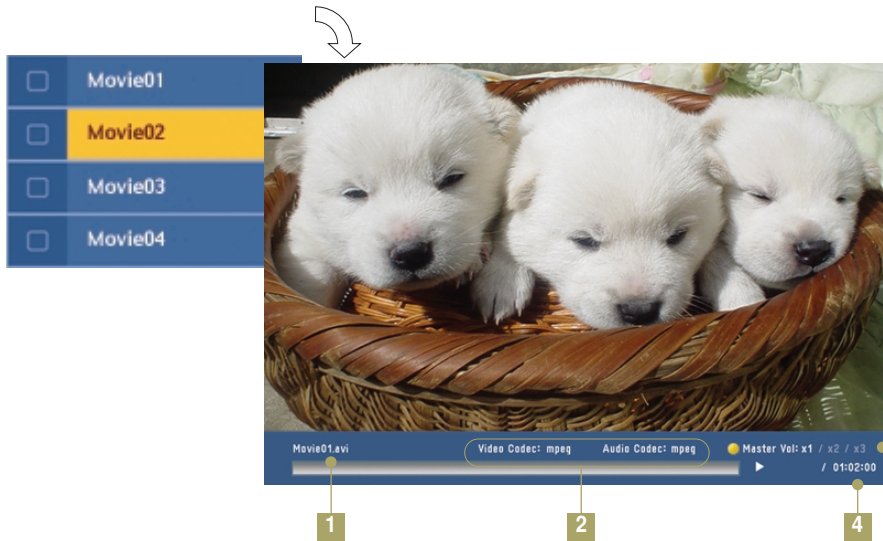

Video may be lost when playing the movie or executing FF/REW, depending on the network condition.

Playing movies





- 1 **View file name** You can check the name of the movie file.
- 2 **View file property** You can check the movie file format.
- 3 **Sound amplification** You can amplify the sound by properly adjusting the default value.
(Press the  **AUDIO** button on the remote control.)
X1: Default volume, X2: 2 times, X3: 3 times
- 4 **View file playback time** You can check the file playback time and all playback time.

Playing previous/next movie file

Press the  button to play back the previous movie file, or press the  button to play back the next one.

Stop/Pause

STOP: Press the  **STOP** button to stop playback of the current file.

PAUSE: Press the  **PAUSE** button to temporarily stop playback.
To resume playback, press the  **PLAY** button.

FF/REWIND (Not available for some formats)

Moves the playback position of the current movie file forward or backward by certain interval.

FF  : Moves forward as much as 2% of the entire file playback length (based on 1 hour).

REWIND  : Moves backward as much as 2% of the entire file playback length (based on 1 hour).

* **Movement position can differ according to the file size.**



Note

The wireless TV supports the following movie file formats.

- **MPEG-1 VCD** (*.mpg, *.mpe, *.mpeg, *.dat, *.m1v)
- **MPEG-2 (SD class)** (*.mpg, *.mpe, *.mpeg, *.vob, *.m2v)
- **WMV9 (SD class)** (*.wmv)
- **AVI** (*.avi)

Audio codec

- MPEG1 Layer I, II, III
- Dolby Digital (AC3)
- DTS
- Windows Media Audio (WMA9)

Video codec

- MPEG-4 (1/2/3)
- Divx 3.11/4/5
- XVID
- WMV9

Supported sub-title file format

- **Sami (*.smi)**

* The sub-title name must be same as that of the movie file to be displayed the sub-title on the TV.

Changing Settings

Changing Settings





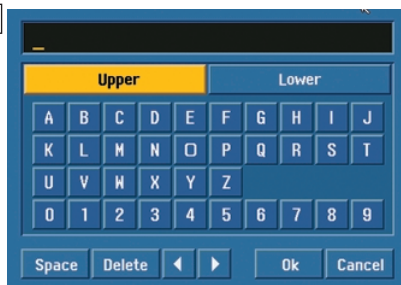



5-1



Virtual keyboard



Input the number or the character you want, using the movement buttons on the remote control.

- 1 **Brightness** Adjusts brightness of the screen. Larger values make the screen brighter.
- 2 **SlideShow** Adjusts the slide show interval.
Slow (15 seconds) -> Normal (10 seconds) -> Fast (5 seconds)
Press the  button after setting.
- 3 **Browse From** Selects the screen when the  TV/MEDIA button is pressed on the remote control.
Home: Home screen appears when switching from TV to Media Browser.
Last mode: Starts from the last screen used.
Press the  button after setting.
- 4 **Select Network** Changes or selects the SSID(network name) of the wireless LAN card (or Access Point(AP)).
Select the wireless network ID to change using the left/right button on the remote control.
- 5 **WEP key** Encryption for security. Assigns the WEP key (password) for wireless LAN card (or Access Point(AP)) setting.
Not in Use: WEP key will not be used.
64bit/128bit: If you apply 64 bits or 128 bits and press the  button, the virtual keyboard screen (5-1) will appear and lets you enter the password.
- 6 **Network** Sets the IP Address, Subnet Mask, and Gateway.
Manual: You should manually input IP Address, Subnet mask and Gateway value.
Automatic: IP Address, Subnet mask and Gateway value will be automatically filled in by the DHCP server. (Nothing will appear on the Setting window.)
- 7 **Select Media Server** Specify the computer that contains the media files to use.
When the Setting Confirmation window appear after setting, press the  button.

* If you press the  HOME button on the remote control when changing the Select Network, WEP key and Network, the 'SEARCH FAILURE' windows appear if you select Exit from the Setting menu. Press the  button again to enter into the Setting menu again.

Check before reporting malfunction

When suspecting a malfunction, check again if the following occur. It may not necessarily be a malfunction.

	Symptoms	Take the following measures
Abnormal Adjustment	<p>Q Screen appears a little late after turning the wireless TV on.</p>	<p>A This phenomenon occurs because of image elimination processing to hide the image noise on the screen when the power is turned on. It is not a malfunction.</p> <p>A The screen may appear a little late depending on the network status.</p>
	<p>Q Screen appears but no sound is heard.</p>	<p>A Check the program of other broadcasting service provider.</p> <p>A Press the  Volume Up button among Volume Up/Down button.</p>
	<p>Q Remote control does not work.</p>	<p>A Check whether there is any obstacle between remote control and wireless TV.</p> <p>A Check whether the battery is inserted with correct polarity.</p> <p>A The battery can be used up. Replace two batteries with new one. (Page 20)</p>
	<p>Q Vertical and horizontal lines as well as net pattern appear on the screen instantly, and the screen shakes.</p>	<p>A Caused by strong electromagnetic interference from a high-frequency electric device or other TV. Possibly caused by a cordless phone, hair dryer, electric drill, etc.</p>
	<p>Q Sreen of all channels or the specific channel is overlapped or the line</p>	<p>A Adjust the direction. i.e., Re-orient the antenna to the broadcasting station.</p>
	<p>Q Color is not displaying properly.</p>	<p>A Check the program of other broadcasting service provider.</p> <p>A Select the color and adjust it using the  Volume Up button. (Page 33)</p>
	<p>Q A strange sound is heard from the wireless TV.</p>	<p>A “Snapping sound” before and after watching TV originates from surrounding environment change because of the characteristics of the plastic products. It is not a malfunction.</p>

Check before reporting malfunction

When suspecting a malfunction, check again if the following occur. It may not necessarily be a malfunction.

	Symptoms	Take the following measures
Abnormal Adjustment	<p>Q Nothing appears on the screen.</p>	<p>A Check whether the battery or the DC adaptor is connected.</p> <p>A If you find that the battery power LED flashes in yellow color when you press the power button, the remaining battery amount is insufficient. Connect the DC adaptor in this case.</p>
	<p>Q No sound is heard.</p>	<p>A Adjust the volume.</p> <p>A Check whether the 'Mute' function is set in the Volume setting menu.</p> <p>A If no sound is heard from the headset, check whether the headset jack is properly connected to the wireless TV.</p> <p>A If the headset is equipped with the volume control function, sound balance setting in the wireless TV may not work properly.</p> <p>A When listening to the music from the wireless TV through the computer, music playback can be interrupted from time to time depending on the wireless network environment.</p>
	<p>Q The screen becomes darker when I separate a DC adapter while the battery is mounted.</p>	<p>A Screen brightness is automatically adjusted for power saving. If the DC adaptor is connected, the previous setting will be restored.</p>
	<p>Q The screen blinks when setting the screen automatically.</p>	<p>A Screen brightness is adjusted twice at the time of automatic screen adjustment. It is not a malfunction.</p>

Check before reporting malfunction

When suspecting a malfunction, check again if the following occur. It may not necessarily be a malfunction.

Symptoms

- Q When I use the Media Browser, the “Check the PC status first. If you want to change the settings, press the  button.” message appears.

Abnormal Adjustment

Take the following measures

- A Check whether the network setting (SSID(network name), WEP key and so on) is correct in the wireless TV.



Check whether the SSID(network name) in ‘**Select Network**’ of the wireless TV setting is identical to that of the computer wireless network. If it is different, set the SSID(network name) of the wireless TV as that of the computer. (See page 46)

The SSID(network name) in ‘**Select Network**’ of the wireless TV setting is set to LGMEDIA by default. But, it can be changed using the wireless network SSID(network name) set in the computer. At this time, the wireless LAN card (or, Access Point(AP)) setting in the computer should be ‘Network between Computers’ (Ad-hoc or peer-to-peer). See the wireless LAN card (or, Access Point(AP)) user’s manual.

- A Check whether the computer is turned on.
- A Check whether the program (Media Library) is properly installed in the computer.
- A Check whether the wireless LAN card (or, Access Point (AP)) is installed properly and it can be used.
- A Check whether the distance from wireless TV and computer is too far away.
- A Check whether the Media Library is allocated to the wireless LAN card (or, Access Point(AP)).

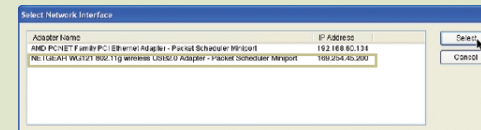

If the wireless LAN card (or, Access Point(AP)) is not allocated, run “Re-start the service with a different IP” and select the network installed with the wireless LAN card (or, Access Point(AP)) and then activate the service.

- A Check whether the ‘Turn off HDD’ option is set on in the power saving mode of the computer.
- A Check the wireless Access Point(AP) setting. If the SSID(network name) is in the hiding mode, it cannot be used.

Check before reporting malfunction

Check again if the following phenomenon occurs, which you presume that it is malfunction. It may not be malfunction indeed.

Symptoms	Take the following measures
<p>Q TV screen display is interrupted from time to time, or not displayed properly.</p>	<ul style="list-style-type: none"> A Check whether the power of the transmission unit is turned on. A First, check whether the power LED in the transmission unit flashes in red color. Then, move the location of the transmission unit to the center of the house or the position where you watch the TV most frequently. A Check whether the distance from wireless TV and computer is too far away. A Reception sensitivity differs according to the direction of the wireless TV and wireless transmission unit. Turn the front side of the wireless transmission unit towards the wireless TV. A Reception sensitivity of the wireless TV also depends on the direction. Find the optimal direction and location inside the house and install the wireless TV. A Do not attach the wireless transmission unit on the bookshelf or the wall to extend the wireless network coverage. A If the TV is turned on properly but not the TV broadcasting, check TV antenna connection and set the channel using the [Ez Scan] function. (See page 30.) <div style="text-align: right;">  <p>Front</p> <p>Wireless transmission unit</p> </div>

Product Specification

The product specification is subject to change without notice for product improvement.

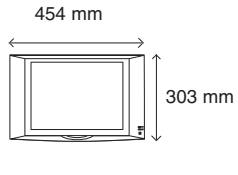
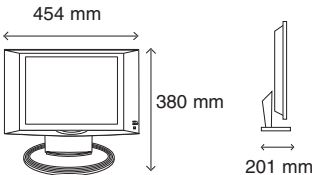
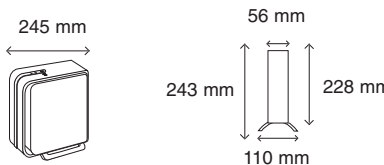
Display Device	15 LCD Panel
Television Standard	NTSC
Receiving Channel	VHF 2~13 channels, UHF 14~69 channels, CATV 01~125 channels
Input Connector	S-Video, Video, TV
Power	Wireless TV: DC 16V 3.0A Wireless Transmission Unit: DC 16V 1.0A
Power Consumption	Wireless TV: 40W Wireless Transmission Unit: 15W
External Antenna Impedance	75Ω
Sound Output	1.5W+1.5W
External Port	See pages 23~27.
Dimension	<p>Size (Width x Length x Height) Weight (excluding package)</p> <ul style="list-style-type: none"> ■ Wireless TV (4.0 Kg)  ■ Wireless TV (4.0 Kg) + Mounting type stand (1.0 Kg)  ■ Wireless Transmission Unit (1.6 Kg)  ■ Battery: 0.4 Kg

MEMO



Free Manuals Download Website

<http://myh66.com>

<http://usermanuals.us>

<http://www.somanuals.com>

<http://www.4manuals.cc>

<http://www.manual-lib.com>

<http://www.404manual.com>

<http://www.luxmanual.com>

<http://aubethermostatmanual.com>

Golf course search by state

<http://golfingnear.com>

Email search by domain

<http://emailbydomain.com>

Auto manuals search

<http://auto.somanuals.com>

TV manuals search

<http://tv.somanuals.com>