



# LG

Life's Good

## LCD TV OWNER'S MANUAL

32LH240H      37LH260H  
32LH250H      42LH260H  
37LH250H      37LH265H  
42LH250H  
32LH255H  
37LH255H  
42LH255H

please read this manual carefully before operating your set.  
Retain it for future reference.  
Record model number and serial number of the set.  
See the label attached on the back cover and quote this information to your dealer when you require service.

**Model:**

**Serial:**



This product qualifies for ENERGY STAR in the "factory default (Home Use)" setting.

Changing the factory default settings or enabling other features may increase power consumption that could exceed the limits necessary to qualify for ENERGY STAR.

**1-800-243-0000** USA, Consumer User  
**1-888-865-3026** USA, Commercial User  
**1-888-542-2623** CANADA

LG Customer Information Center

P/NO : SAC34026004 (0912-REV00)



# WARNING / CAUTION



**WARNING / CAUTION**  
RISK OF ELECTRIC SHOCK  
DO NOT OPEN



TO REDUCE THE RISK OF ELECTRIC SHOCK  
DO NOT REMOVE COVER (OR BACK). NO  
USER SERVICEABLE PARTS INSIDE. REFER TO  
QUALIFIED SERVICE PERSONNEL.



The lightning flash with arrowhead symbol, within an equilateral triangle, is intended to alert the user to the presence of uninsulated “dangerous voltage” within the product’s enclosure that may be of sufficient magnitude to constitute a risk of electric shock to persons.



The exclamation point within an equilateral triangle is intended to alert the user to the presence of important operating and maintenance (servicing) instructions in the literature accompanying the appliance.

## WARNING/CAUTION

TO REDUCE THE RISK OF FIRE AND ELECTRIC SHOCK, DO NOT EXPOSE THIS PRODUCT TO RAIN OR MOISTURE.

## NOTE TO CABLE/TV INSTALLER

This reminder is provided to call the CATV system installer’s attention to Article 820-40 of the National Electric Code (U.S.A.). The code provides guidelines for proper grounding and, in particular, specifies that the cable ground shall be connected to the grounding system of the building, as close to the point of the cable entry as practical.

## WARNING / CAUTION

To prevent fire or shock hazards, do not expose this product to rain or moisture.

## FCC NOTICE

### Class B digital device

This equipment has been tested and found to comply with the limits for a Class B digital device, pursuant to Part 15 of the FCC Rules. These limits are designed to provide reasonable protection against harmful interference in a residential installation. This equipment generates, uses and can radiate radio frequency energy and, if not installed and used in accordance with the instructions, may cause harmful interference to radio communications. However, there is no guarantee that interference will not occur in a particular installation. If this equipment does cause harmful interference to radio or television reception, which can be determined by turning the equipment off and on, the user is encouraged to try to correct the interference by one or more of the following measures:

- Reorient or relocate the receiving antenna.
- Increase the separation between the equipment and receiver.
- Connect the equipment to an outlet on a circuit different from that to which the receiver is connected.
- Consult the dealer or an experienced radio/TV technician for help.

This device complies with part 15 of the FCC Rules.

Operation is subject to the following two conditions: (1) This device may not cause (harmful) interference, and (2) this device must accept any interference received, including interference that may cause undesired operation (of the device).

**Any changes or modifications in construction of this device which are not expressly approved by the party responsible for compliance could void the user’s authority to operate the equipment.**

## CAUTION

Do not attempt to modify this product in any way without written authorization from LG Electronics. Unauthorized modification could void the user’s authority to operate this product

# SAFETY INSTRUCTIONS

## IMPORTANT SAFETY INSTRUCTIONS

Read these instructions.

Keep these instructions.

Heed all warnings.

Follow all instructions.



- 1** Do not use this apparatus near water.

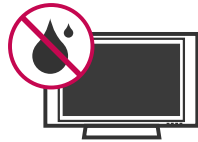

- 2** Clean only with dry cloth.



- 3** Do not block any ventilation openings. Install in accordance with the manufacturer's instructions.



- 4** Do not install near any heat sources such as radiators, heat registers, stoves, or other apparatus (including amplifiers) that produce heat.



- 5** Do not defeat the safety purpose of the polarized or grounding-type plug. A polarized plug has two blades with one wider than the other. A grounding type plug has two blades and a third grounding prong. The wide blade or the third prong are provided for your safety. If the provided plug does not fit into your outlet, consult an electrician for replacement of the obsolete outlet.



- 6** Protect the power cord from being walked on or pinched particularly at plugs, convenience receptacles, and the point where they exit from the apparatus.



- 7** Only use attachments/accessories specified by the manufacturer.



- 8** Use only with the cart, stand, tripod, bracket, or table specified by the manufacturer, or sold with the apparatus. When a cart is used, use caution when moving the cart/apparatus combination to avoid injury from tip-over.



- 9** Unplug this apparatus during lightning storms or when unused for long periods of time.

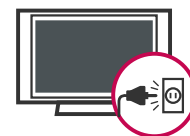

- 10** Refer all servicing to qualified service personnel. Servicing is required when the apparatus has been damaged in any way, such as power-supply cord or plug is damaged, liquid has been spilled or objects have fallen into the apparatus, the apparatus has been exposed to rain or moisture, does not operate normally, or has been dropped.

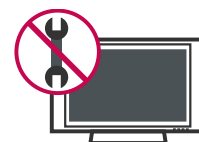

**11** Never touch this apparatus or antenna during a thunder or lighting storm.

**12** When mounting a TV on the wall, make sure not to install the TV by the hanging power and signal cables on the back of the TV.

**13** Do not allow an impact shock or any objects to fall into the product, and do not drop onto the screen with something.

**14** **CAUTION** concerning the Power Cord :  
It is recommend that appliances be placed upon a dedicated circuit; that is, a single outlet circuit which powers only that appliance and has no additional outlets or branch circuits. Check the specification page of this owner's manual to be certain. Do not connect too many appliances to the same AC power outlet as this could result in fire or electric shock.

Do not overload wall outlets. Overloaded wall outlets, loose or damaged wall outlets, extension cords, frayed power cords, or damaged or cracked wire insulation are dangerous. Any of these conditions could result in electric shock or fire. Periodically examine the cord of your appliance, and if its appearance indicates damage or deterioration, unplug it, discontinue use of the appliance, and have the cord replaced with an exact replacement part by an authorized servicer. Protect the power cord from physical or mechanical abuse, such as being twisted, kinked, pinched, closed in a door, or walked upon. Pay particular attention to plugs, wall outlets, and the point where the cord exits the appliance.

Do not make the TV with the power cord plugged in. Do not use a damaged or loose power cord. Be sure do grasp the plug when unplugging the power cord. Do not pull on the power cord to unplug the TV.

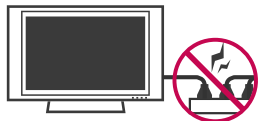

**15** **WARNING** - To reduce the risk of fire or electrical shock, do not expose this product to rain, moisture or other liquids. Do not touch the TV with wet hands. Do not install this product near flammable objects such as gasoline or candles or expose the TV to direct air conditioning.



**16** Do not expose to dripping or splashing and do not place objects filled with liquids, such as vases, cups, etc. on or over the apparatus (e.g. on shelves above the unit).



## **17** GROUNDING

Ensure that you connect the earth ground wire to prevent possible electric shock. (i.e. a TV with a three-prong grounded AC plug must be connected to a three-prong grounded AC outlet) If grounding methods are not possible, have a qualified electrician install a separate circuit breaker.

Do not try to ground the unit by connecting it to telephone wires, lightening rods, or gas pipes.

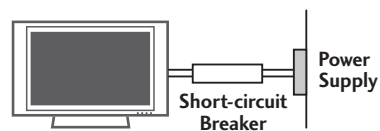

## **18** DISCONNECTING DEVICE FROM MAINS

Mains plug is the disconnecting device. The plug must remain readily operable.

## 19 ANTENNAS

### Outdoor antenna grounding

If an outdoor antenna is installed, follow the precautions below. An outdoor antenna system should not be located in the vicinity of overhead power lines or other electric light or power circuits, or where it can come in contact with such power lines or circuits as death or serious injury can occur.

Be sure the antenna system is grounded so as to provide some protection against voltage surges and built-up static charges.

Section 810 of the National Electrical Code (NEC) in the U.S.A. provides information with respect to proper grounding of the mast and supporting structure, grounding of the lead-in wire to an antenna discharge unit, size of grounding conductors, location of antenna discharge unit, connection to grounding electrodes and requirements for the grounding electrode.

### Antenna grounding according to the National Electrical Code, ANSI/NFPA 70

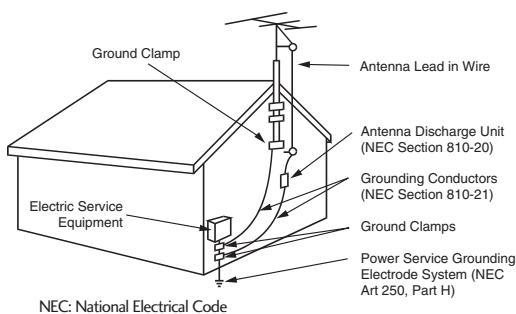

## 20 Cleaning

When cleaning, unplug the power cord and scrub gently with a soft cloth to prevent scratching. Do not spray water or other liquids directly on the TV as electric shock may occur. Do not clean with chemicals such as alcohol, thinners or benzene.

## 21 Moving

Make sure the product is turned off, unplugged and all cables have been removed. It may take 2 or more people to carry larger TVs. Do not press against or put stress on the front panel of the TV.

## 22 Ventilation

Install your TV where there is proper ventilation. Do not install in a confined space such as a bookcase. Do not cover the product with cloth or other materials (e.g.) plastic while plugged in. Do not install in excessively dusty places.

## 23 Take care not to touch the ventilation openings. When watching the TV for a long period, the ventilation openings may become hot.

## 24 If you smell smoke or other odors coming from the TV or hear strange sounds, unplug the power cord contact an authorized service center.

## 25 Do not press strongly upon the panel with a hand or sharp object such as nail, pencil or pen, or make a scratch on it.

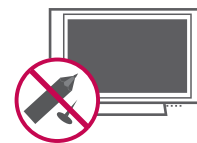

## 26 Keep the product away from direct sunlight.

## 27 For LCD TV

If the TV feels cold to the touch, there may be a small "flicker" when it is turned on. This is normal, there is nothing wrong with TV.

Some minute dot defects may be visible on the screen, appearing as tiny red, green, or blue spots. However, they have no adverse effect on the monitor's performance.

Avoid touching the LCD screen or holding your finger(s) against it for long periods of time. Doing so may produce some temporary distortion effects on the screen.

### ON DISPOSAL

#### (Only Hg lamp used LCD TV)

The fluorescent lamp used in this product contains a small amount of mercury. Do not dispose of this product with general household waste. Disposal of this product must be carried out in accordance to the regulations of your local authority.

# CONTENTS

<b>WARNING / CAUTION</b> .....	1
<b>SAFETY INSTRUCTIONS</b> .....	2
<b>FEATURES OF THIS TV</b> .....	7

## PREPARATION

Accessories .....	8
Front Panel Information .....	9
Back Panel Information .....	10
Stand Instruction .....	12
VESA Wall Mounting .....	14
Cable Management .....	15
Desktop Pedestal Installation .....	16
Swivel Stand .....	16
Attaching the TV to a desk .....	17
Securing the TV to the wall to prevent falling When the TV is used on a stand .....	18
Antenna or Cable Connection .....	19

## EXTERNAL EQUIPMENT SETUP

HD Receiver Setup .....	20
DVD Setup .....	23
VCR Setup .....	25
Other A/V Source Setup .....	26
PC Setup .....	27
USB Connection .....	33

## WATCHING TV / CHANNEL CONTROL

Remote Control Functions .....	34
Turning On TV .....	36
Channel Selection .....	36
Volume Adjustment .....	36
On-Screen Menus Selection .....	37
Channel Setup	
- Auto Scan (Auto Tuning) .....	38
- Add / Delete Channel (Manual Tuning) .....	39
- Channel Editing .....	40
Channel Label .....	41
Input List .....	42

## USB

Entry Modes .....	43
Photo List .....	45
Music List .....	49

## PICTURE CONTROL

Picture Size (Aspect Ratio) Control .....	52
Preset Picture Settings	
- Picture Mode - Preset .....	54
- Color Tone Preset .....	55
Manual Picture Adjustment - User Mode .....	56
Picture Improvement Technology .....	57
Advanced Control - Black (Darkness) Level .....	58
Advanced Control - Eye Care .....	59
Advanced Control - Film Mode .....	60
Picture Reset .....	61
Demo mode .....	61

## SOUND & LANGUAGE CONTROL

Auto Volume Leveler (Auto Volume) .....	62
Preset Sound Settings (Sound Mode) .....	63
Sound Setting Adjustment - User Mode .....	64
- SRS TruSurround XT .....	65
Clear Voice II .....	66
Balance .....	67
TV Speakers On/Off Setup .....	68
Audio Reset .....	69
Stereo/SAP Broadcast Setup .....	70
Audio Language .....	71
On-Screen Menus Language Selection .....	72
Caption Mode	
- Analog Broadcasting System Captions .....	73
- Digital Broadcasting System Captions .....	74
- Caption Option .....	75

## TIME SETTING

Clock Setting	
- Auto Clock Setup .....	76
- Manual Clock Setup .....	77
Auto On/Off Time Setting .....	78
Sleep Timer Setting .....	79

## PARENTAL CONTROL / RATINGS

Set Password & Lock System .....	80
Channel Blocking .....	83
Movie & TV Rating .....	84
Downloadable Rating .....	87
External Input Blocking .....	88

## APPENDIX

Troubleshooting .....	89
Maintenance .....	91
Product Specifications .....	91
IR Codes .....	92
Open Source License .....	94



# FEATURES OF THIS TV



HDMI™, the HDMI logo and High-Definition Multimedia Interface are trademarks or registered trademarks of HDMI Licensing LLC."



Manufactured under license from Dolby Laboratories. "Dolby" and the double-D symbol are trademarks of Dolby Laboratories.



View videos and photos and listen to music on your TV through USB 2.0 ('videos' dependent on model).



SRS® is a trademark of SRS Labs, Inc. TruSurround XT technology is incorporated under license from SRS Labs, Inc.



High-definition television. High-resolution digital television broadcast and playback system composed of roughly a million or more pixels, 16:9 aspect-ratio screens, and AC3 digital audio. A subset of digital television, HDTV formats include 1080i and 720p resolutions.



Automatically enhances and amplifies the sound of human voice frequency range to help keep dialogue audible when background noise swells.



LG TV include a unique invisible speaker system, tuned by renowned audio expert, Mr. Mark Levinson. Speakers are embedded in strategic spots behind the front cabinet and use minute vibrations to turn the entire front bezel into the speaker system. The result is a clean, polished look, and enhanced audio by increasing the "sweet spot", giving a wider and richer sound field.



Matches the original frame rate of the film for a more film-like experience



## IMPORTANT INFORMATION TO PREVENT "IMAGE BURN / BURN-IN" ON YOUR TV SCREEN

- When a fixed image (e.g. logos, screen menus, video game, and computer display) is displayed on the TV for an extended period, it can become permanently imprinted on the screen. This phenomenon is known as "image burn" or "burn-in." Image burn is not covered under the manufacturer's warranty.
- In order to prevent image burn, avoid displaying a fixed image on your TV screen for a prolonged period (2 or more hours for LCD, 1 or more hours for Plasma).
- Image burn can also occur on the letterboxed areas of your TV if you use the 4:3 aspect ratio setting for an extended period.

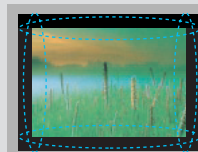
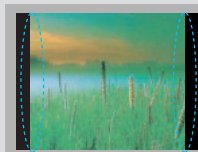

# PREPERATION

## ACCESSORIES

Ensure that the following accessories are included with your TV. If an accessory is missing, please contact the dealer where you purchased the TV.

The accessories included may differ from the images below.

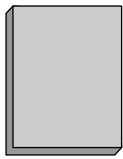

Owner's Manual



CD Manual

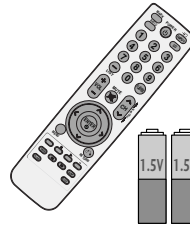

Remote Control,  
Batteries

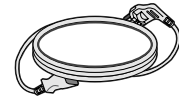

Power Cord

### Not included with all models

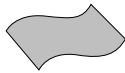

Polishing Cloth

- \* Wipe spots on the exterior only with the polishing cloth.
- \* Do not wipe roughly when removing stain. Excessive pressure may cause scratch or discoloration.

### Option Extras

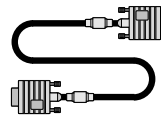

D-sub 15 pin Cable

When using the VGA (D-sub 15 pin cable) PC connection, the user must use shielded signal interface cables with ferrite cores to maintain standards compliance.



Bolts for stand assembly  
(Refer to P.12)



Torx plus  
Star head screw  
(Refer to P.12)

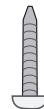

Screw for stand fixing  
(Refer to P.17)



Protection Cover  
(Refer to P.13)

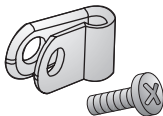

Protective Bracket and Bolt for  
Power Cord  
(This feature is not available for all models.)  
(Refer to P.15)



Cable Holder  
(Refer to P.15)



Plug in type holder  
(Refer to P.15)

# FRONT PANEL INFORMATION

■ Image shown may differ from your TV.

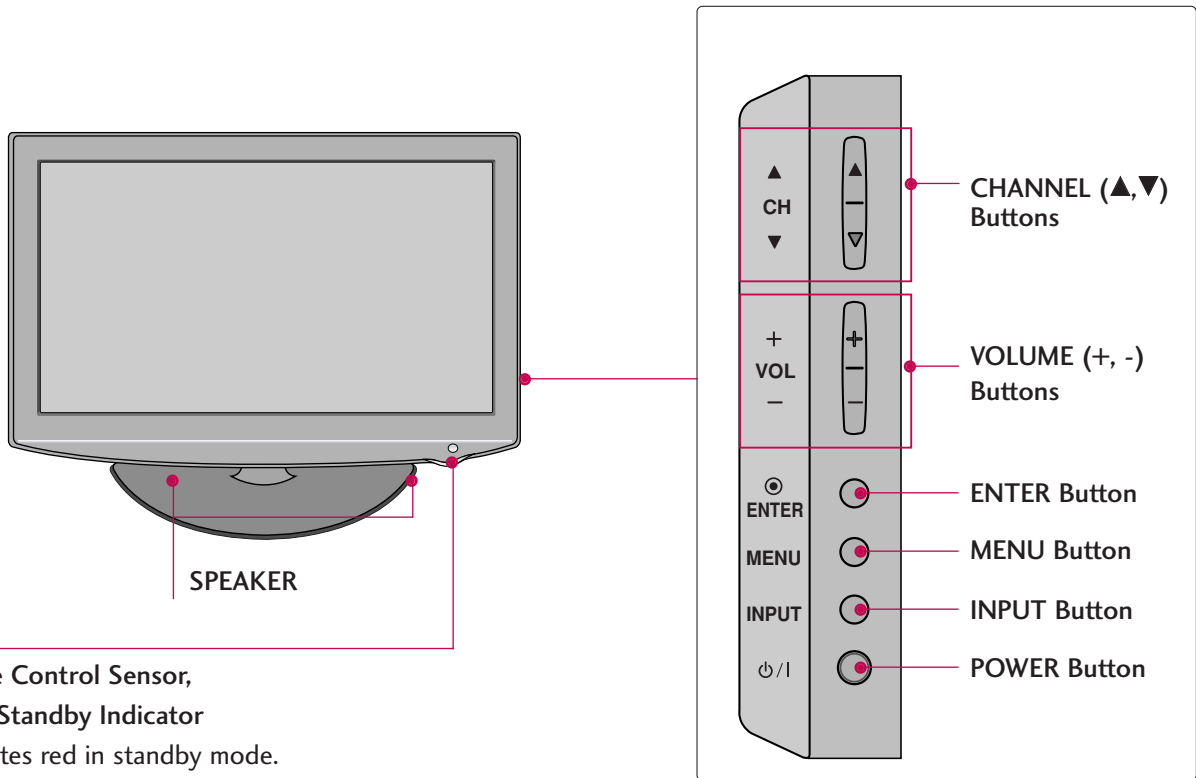

Remote Control Sensor,  
 Power/Standby Indicator  
 Illuminates red in standby mode.  
 Illuminates blue when the TV is switched on.

# PREPARATION

## BACK PANEL INFORMATION

Image shown may differ from your TV.

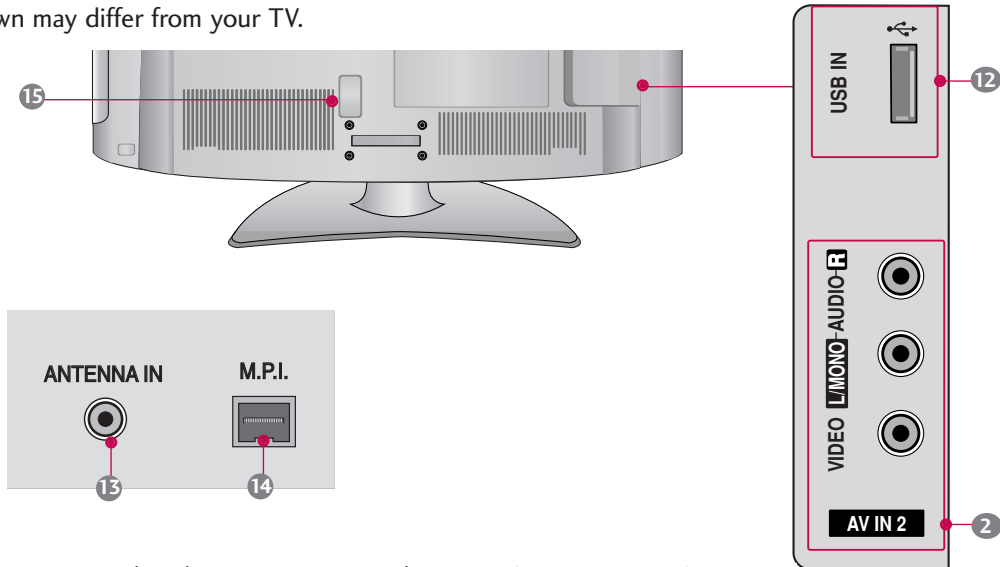

32/37/42LH250H, 32/37/42LH255H, 37/42LH260H, 37LH265H

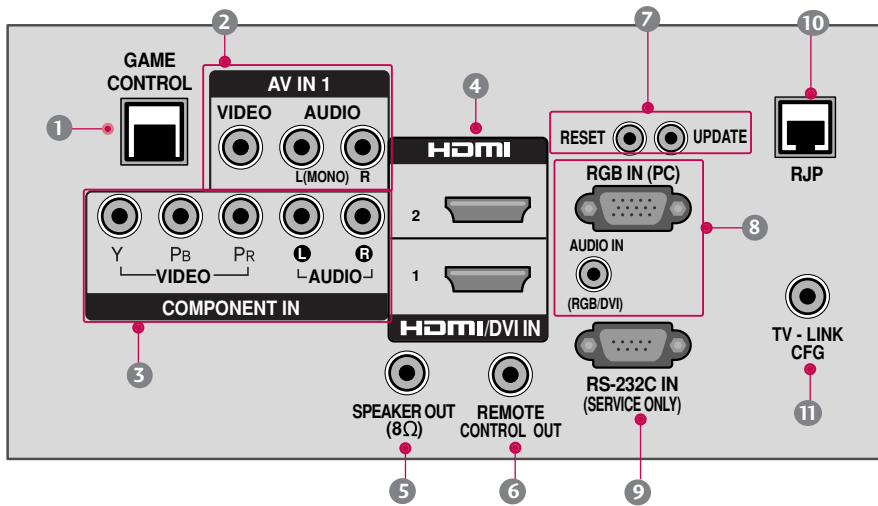

32LH240H

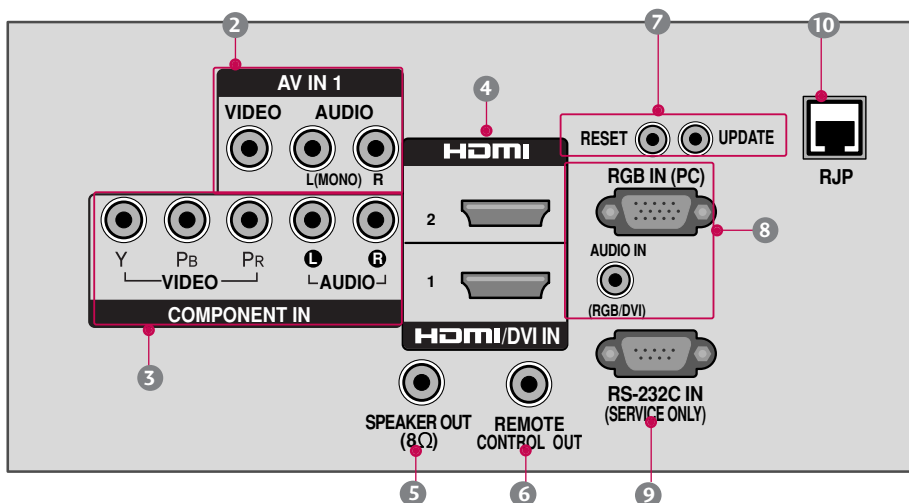

- 1 GAME CONTROL**  
Control port
- 2 AV (Audio/Video) IN**  
Analog composite connection. Supports standard definition video only (480i).  
Used for PC/DTV audio input jack.
- 3 COMPONENT IN**  
Analog Connection.  
Supports HD.  
Uses a red, green, and blue cable for video & a red and white cable for audio.
- 4 HDMI/DVI IN**  
Digital Connection. Supports HD video and Digital audio.  
Accepts DVI video using an adapter or HDMI to DVI cable (not included)
- 5 SPEAKER OUT 8Ω**  
Connect to external speaker input.
- 6 REMOTE CONTROL OUT**  
IR output for controlling an auxiliary device.
- 7 UPDATE**  
Enables/disables software downloads and debug mode.  
**RESET**  
Performs a hardware reset.
- 8 RGB IN (PC)**  
Analog PC Connection. Uses a D-sub 15 pin cable (VGA cable).  
**AUDIO IN (RGB/DVI)**  
1/8" headphone jack for analog PC audio input.
- 9 RS-232C IN (SERVICE ONLY)**  
Used for software updates.
- 10 RJP (REMOTE JACK PACK PORT)**  
Connect to remote jack pack control output port.
- 11 TV - LINK CFG**  
Used for FTG Configuration
- 12 USB IN**  
Used for viewing photos and listening to MP3s.
- 13 ANTENNA IN**  
Connect over-the air signals to this jack.
- 14 M.P.I.**  
Control port.
- 15 Power Cord Socket**  
For operation with AC power.  
Caution: Never attempt to operate the TV on DC power.

# PREPARATION

## STAND INSTRUCTION

- Image shown may differ from your TV.

## INSTALLATION

- 1 Carefully place the TV screen side down on a cushioned surface to protect the screen from damage.

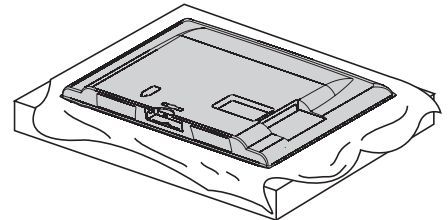

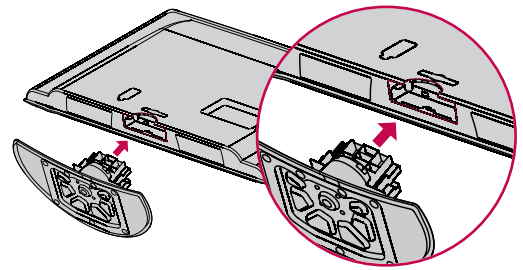

- 2 Assemble the TV as shown.



- 3  x 4  
Tighten the stand with the four screws (provided as parts of the TV).

or

-  x 2  x 2 Tighten the two of these four screws and the two Torx plus star head screws (provided as parts of the TV) to secure the TV. Tighten the two Torx plus star head screws with a star head driver bit (not provided as parts of the TV).

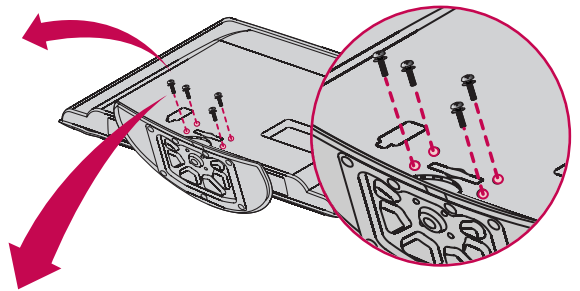

### ! NOTE

- ▶ When assembling the desk type stand, make sure the bolt is fully tightened (If not tightened fully, the TV can tilt forward after the product installation). Do not over tighten.
- ▶ When assembling the stand as in figure 2 above, you can hear some disturbing noise which is by the cable management disturbing the stand. Please ignore the noise and try again assembling the stand after setting the cable management in the right position.

## DETACHMENT

- 1 Carefully place the TV screen side down on a cushioned surface to protect the screen from damage.

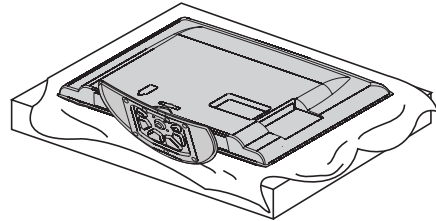

- 2 Loosen the bolts from the TV.

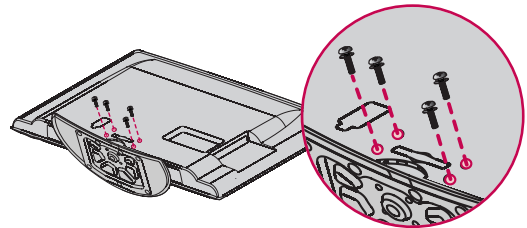

- 3 Detach the stand from the TV.

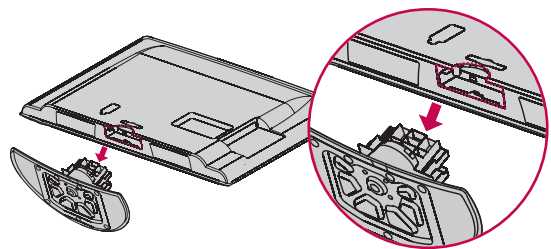

## PROTECTION COVER

After removing the stand, install the included **protection cover** over the hole for the stand. Press the **PROTECTION COVER** into the TV until you hear it click.

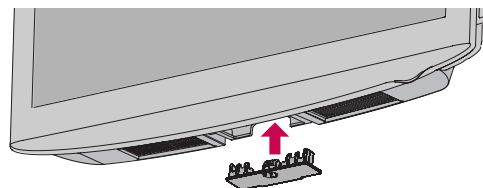

# PREPARATION

## VESA WALL MOUNTING

Install your wall mount on a solid wall perpendicular to the floor. When attaching to other building materials, please contact your nearest installer.

If installed on a ceiling or slanted wall, it may fall and result in severe personal injury.

We recommend that you use an LG brand wall mount when mounting the TV to a wall.

LG recommends that wall mounting be performed by a qualified professional installer.

PREPARATION

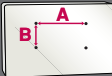
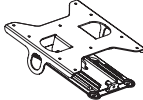
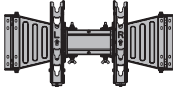
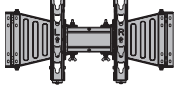
Model	VESA (A * B) 	Standard Screw	Quantity	Wall Mounting Bracket (sold separately)	
32LH240H, 32LH250H, 32LH255H	200 * 100	M4	4	 RW230	 AW-47LG30M
37LH250H, 37LH255H, 37LH260H, 37LH265H, 42LH255H, 42LH260H, 42LH265H	200 * 200	M6	4	 AW-47LG30M	

### NOTE

- ▶ Screw length needed depends on the wall mount used. For further information, refer to the instructions included with the mount.
- ▶ Standard dimensions for wall mount kits are shown in the table.
- ▶ When purchasing our wall mount kit, a detailed installation manual and all parts necessary for assembly are provided.
- ▶ Do not use screws longer than the standard dimension, as they may cause damage to the inside to the TV.
- ▶ For wall mounts that do not comply with the VESA standard screw specifications, the length of the screws may differ depending on their specifications.
- ▶ Do not use screws that do not comply with the VESA standard screw specifications.
- ▶ Do not use fasten the screws too strongly, this may damage the TV or cause the TV to a fall, leading to personal injury. LG is not liable for these kinds of accidents.
- ▶ LG is not liable for TV damage or personal injury when a non-VESA or non specified wall mount is used or the consumer fails to follow the TV installation instructions.

### CAUTION

- ▶ Do not install your wall mount kit while your TV is turned on. It may result in personal injury due to electric shock.



# CABLE MANAGEMENT

■ Image shown may differ from your TV.

- 1** Connect the cables as necessary.  
To connect additional equipment, see the **EXTERNAL EQUIPMENT SETUP** section. Secure the power cable with the **PROTECTIVE BRACKET/Screw** or the **Plug in type Holder**. It will help prevent the power cable from being removed by accident.

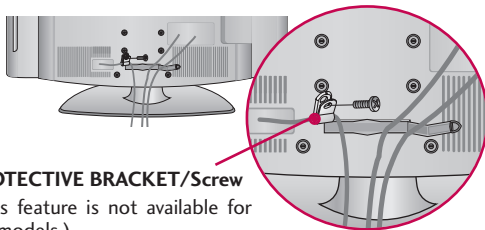

**PROTECTIVE BRACKET/Screw**  
(This feature is not available for all models.)

Or

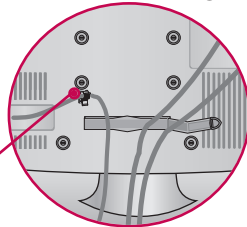

**PLUG IN TYPE HOLDER**

- 2** Install the **CABLE MANAGEMENT CLIP** as shown.  
If your TV has the **CABLE HOLDER**, install it as shown and bundle the cables.

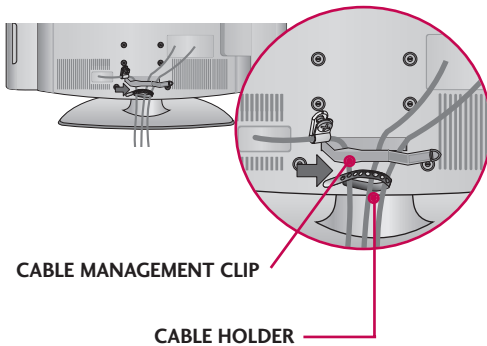

**CABLE MANAGEMENT CLIP**

**CABLE HOLDER**

- 3** Put the cables inside the **CABLE MANAGEMENT CLIP** and snap it closed.

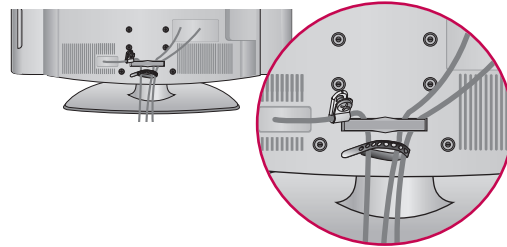

## ! NOTE

- ▶ Do not hold the **CABLE MANAGEMENT CLIP** when moving the TV.  
- If the TV is dropped, you may be injured or the product may be broken.
- ▶ With some TVs, the **PLUG IN TYPE HOLDER** and the **CABLE HOLDER** are included. If these holders are inserted into the hole provided on back of the TV, they cannot be removed.

# PREPARATION

## DESKTOP PEDESTAL INSTALLATION

- Image shown may differ from your TV.

For proper ventilation, allow a clearance of 4 inches on all four sides from the wall.

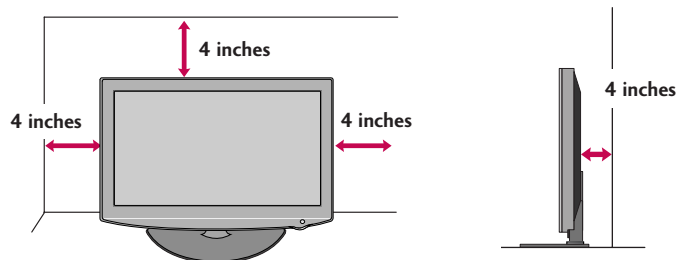

### ⚠ CAUTION

- ▶ Ensure adequate ventilation by following the clearance recommendations.
- ▶ Do not mount near or above any type of heat source.

## SWIVEL STAND

After installing the TV, you can adjust the TV set manually to the left or right direction by 90 degrees to suit your viewing position.

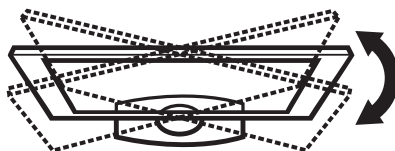

## ATTACHING THE TV TO A DESK

- Image shown may differ from your TV.

The TV must be attached to a desk so it cannot be pulled in a forward/backward direction, potentially causing injury or damaging the product.

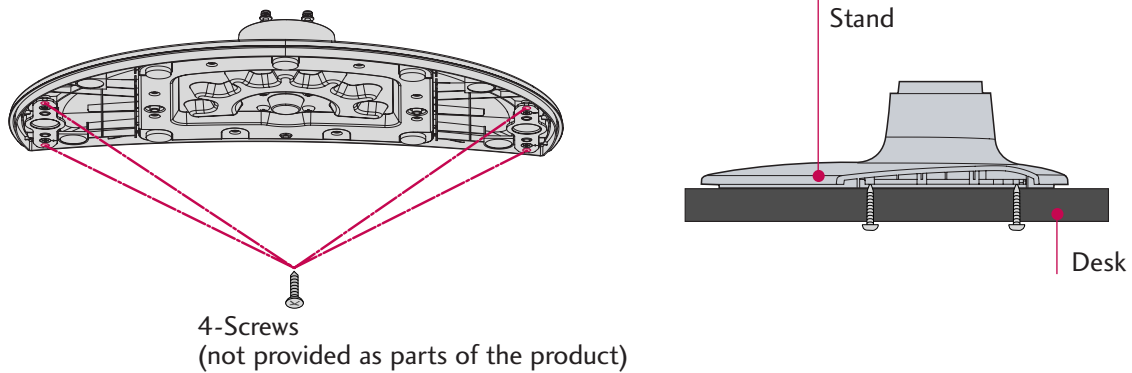

- Screw: M5 x L (\*L: Table depth + 8~10 mm)  
ex) Table depth: 15mm, Screw: M5 x 25

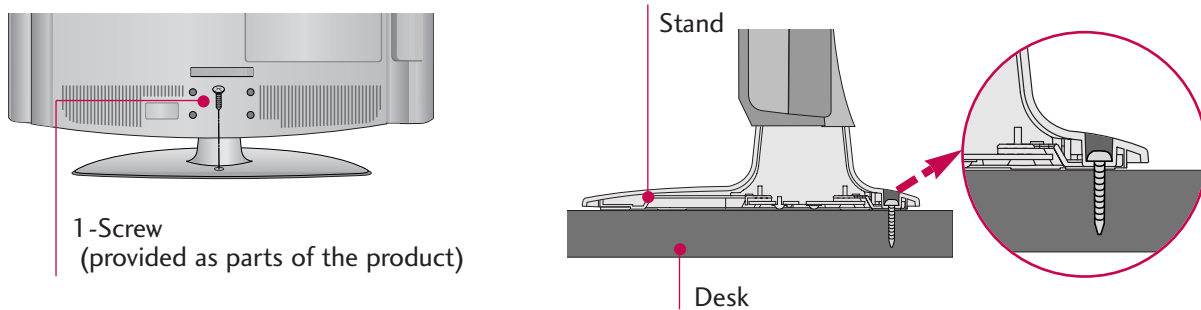

### ⚠ WARNING

- To prevent TV from falling over, the TV should be securely attached to the floor/wall per installation instructions. Tipping, shaking, or rocking the machine may cause injury.

# PREPARATION

## SECURING THE TV TO THE WALL TO PREVENT FALLING WHEN THE TV IS USED ON A STAND

- You should purchase necessary components to prevent the TV from tipping over (when not using a wall mount).
- Image shown may differ from your TV.

We recommend that you set up the TV close to a wall so it cannot fall over if pushed backwards.

Additionally, we recommend that the TV be attached to a wall so it cannot be pulled in a forward direction, potentially causing injury or damaging the product.

Caution: Please make sure that children don't climb on or hang from the TV.

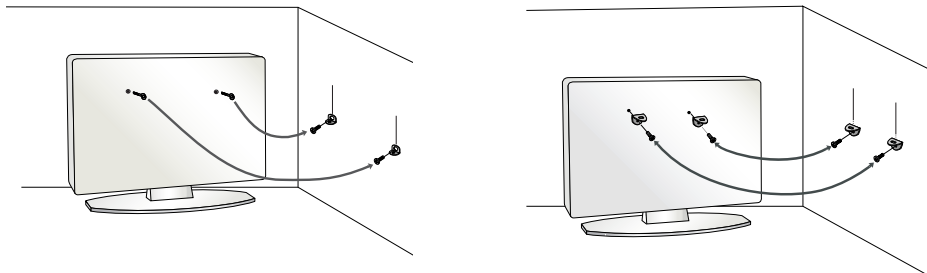

- Insert the eye-bolts (or TV brackets and bolts) to tighten the product to the wall as shown in the picture.

\* If your product has the bolts in the eye-bolts position before inserting the eye-bolts, loosen the bolts.

\* Insert the eye-bolts or TV brackets/bolts and tighten them securely in the upper holes.

Secure the wall brackets with the bolts (sold separately) to the wall. Match the height of the bracket that is mounted on the wall to the holes in the product.

Ensure the eye-bolts or brackets are tightened securely.

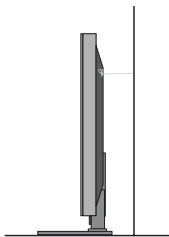

- Use a sturdy rope (sold separately) to tie the product. It is safer to tie the rope so it becomes horizontal between the wall and the product.

### ! NOTE

- ▶ Use a platform or cabinet strong enough and large enough to support the size and weight of the TV.
- ▶ To use the TV safely make sure that the height of the bracket on the wall and the one on the TV are the same.

- To prevent damage do not connect to the power outlet until all connections are made between the devices.

## ANTENNA OR CABLE CONNECTION

### 1. Antenna (Analog or Digital)

Wall Antenna Socket or Outdoor Antenna without a Cable Box Connection.

For optimum picture quality, adjust the direction if needed.

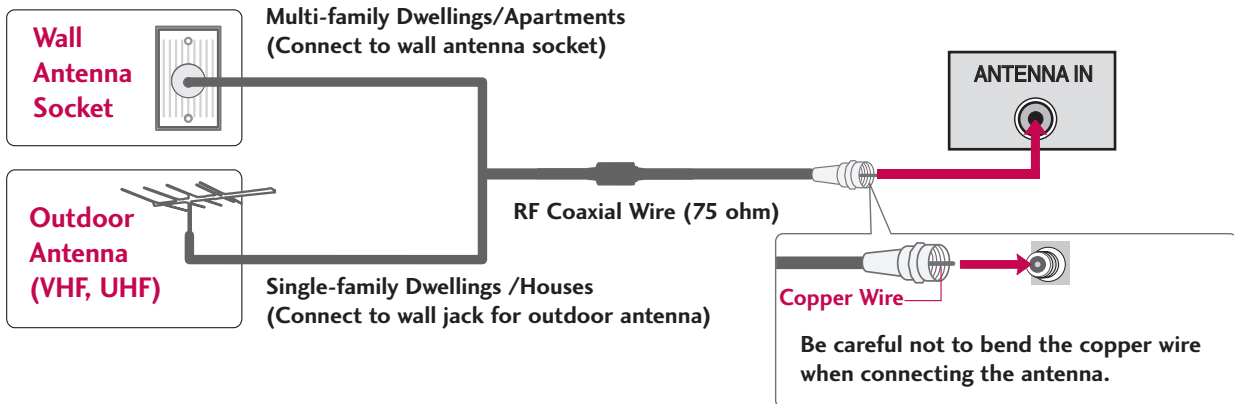

### 2. Cable



- To improve the picture quality in a poor signal area, please purchase a signal amplifier and install properly.
- If the antenna needs to be split for two TV's, install a 2-Way Signal Splitter.
- If the antenna is not installed properly, contact your dealer for assistance.

# EXTERNAL EQUIPMENT SETUP

- To prevent the equipment damage, never plug in any power cords until you have finished connecting all equipment.
- Image shown may differ from your TV.

## HD RECEIVER SETUP

This TV can receive Digital Over-the-air or Digital Cable signals without an external digital set-top box. However, if you do receive digital signals from a digital set-top box or other digital external device, refer to the figure as shown below.

### Component Connection

#### 1. How to connect

- 1 Connect the video outputs (Y, PB, PR) of the digital set-top box to the **COMPONENT IN VIDEO** jacks on the TV. Match the jack colors (Y = green, PB = blue, and PR = red).
- 2 Connect the audio output of the digital set-top box to the **COMPONENT IN AUDIO** jacks on the TV.

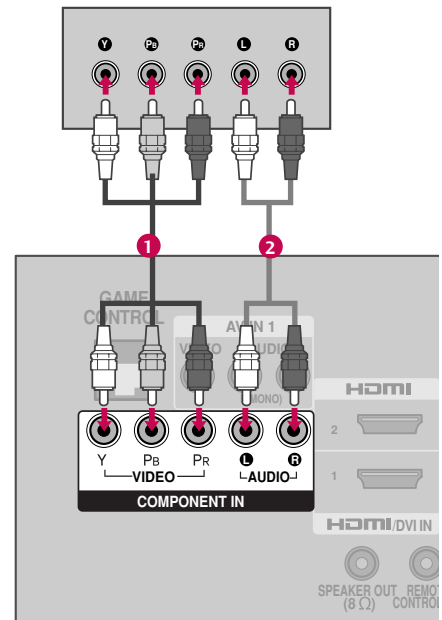

#### 2. How to use

- Turn on the digital set-top box.  
(Refer to the owner's manual for the digital set-top box.)
- Select **Component** input source using the **INPUT** button on the remote control.

#### Supported Resolutions

Signal	Component	HDMI
480i	Yes	No
480p	Yes	Yes
720p	Yes	Yes
1080i	Yes	Yes
1080p	Yes	Yes

#### Y, CB/PB, CR/PR

Resolution	Horizontal Frequency(KHz)	Vertical Frequency(Hz)
720x480i	15.73	59.94
	15.73	60.00
720x480p	31.47	59.94
	31.50	60.00
1280x720p	44.96	59.94
	45.00	60.00
1920x1080i	33.72	59.94
	33.75	60.00
1920x1080p	67.432	59.94
	67.50	60.00
	27.00	24.00
	26.97	23.976
	33.75	30.00
	33.71	29.97

## HDMI Connection

### 1. How to connect

- 1 Connect the digital set-top box to **HDMI /DVI IN 1** or **HDMI 2** jack on the TV.
- 2 No separate audio connection is necessary. HDMI supports both audio and video.

### 2. How to use

- Turn on the digital set-top box.  
(Refer to the owner's manual for the digital set-top box.)
- Select **HDMI1** or **HDMI2** input source with using the **INPUT** button on the remote control.

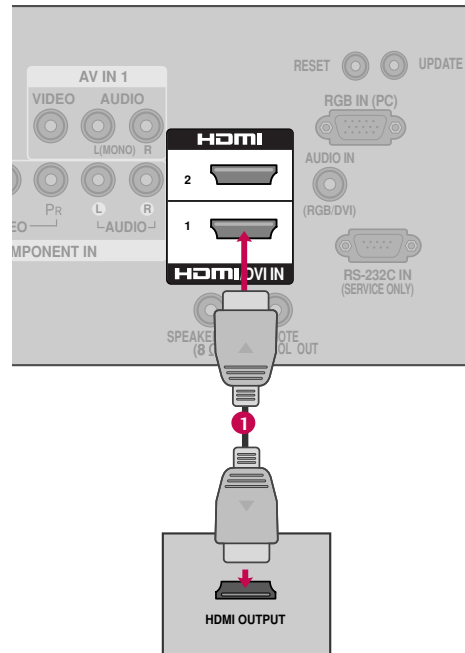

#### HDMI-DTV

Resolution	Horizontal Frequency(KHz)	Vertical Frequency(Hz)
720x480p	31.47	59.94
	31.47	60.00
1280x720p	44.96	59.94
	45.00	60.00
1920x1080i	33.72	59.94
	33.75	60.00
1920x1080p	67.432	59.939
	67.50	60.00
	27.00	24.00
	26.97	23.976
	33.75	30.00
	33.71	29.97

# EXTERNAL EQUIPMENT SETUP

## DVI to HDMI Connection

### 1. How to connect

- 1 Connect the DVI output of the digital set-top box to the **HDMI/DVI IN 1** jack on the TV.
- 2 Connect the audio output of the digital set-top box to the **AUDIO IN (RGB/DVI)** jack on the TV.

### 2. How to use

- Turn on the digital set-top box. (Refer to the owner's manual for the digital set-top box.)
- Select the **HDMI 1** input source on the TV using the **INPUT** button on the remote control.

#### ! NOTE

- ▶ A DVI to HDMI cable or adapter is required for this connection. DVI doesn't support audio, so a separate audio connection is necessary.

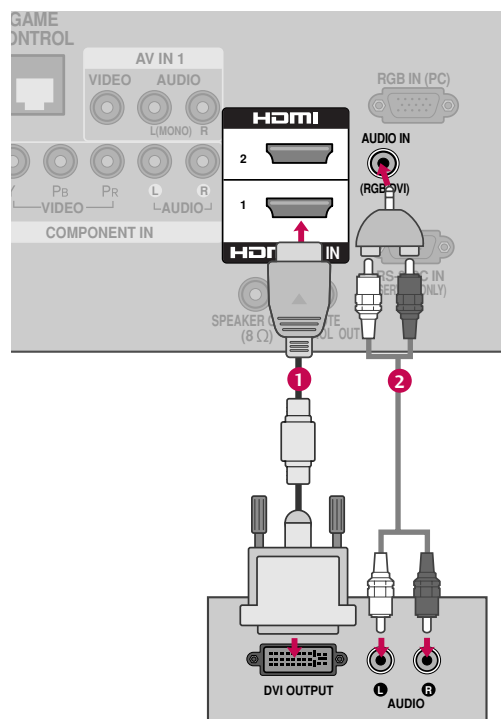



# DVD SETUP

## Component Connection

### 1. How to connect

- 1 Connect the video outputs (Y, P<sub>B</sub>, P<sub>R</sub>) of the DVD to the **COMPONENT IN VIDEO** jacks on the TV. Match the jack colors (Y = green, P<sub>B</sub> = blue, and P<sub>R</sub> = red).
- 2 Connect the audio outputs of the DVD to the **COMPONENT IN AUDIO** jacks on the TV.

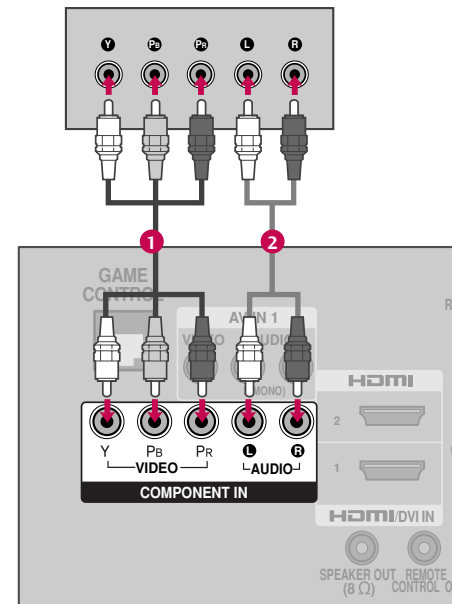

### 2. How to use

- Turn on the DVD player, insert a DVD.
- Select the **Component** input source on the TV using the **INPUT** button on the remote control.
- Refer to the DVD player's manual for operating instructions.

### Component Input ports

To get better picture quality, connect a DVD player to the component input ports as shown below.

Component ports on the TV	Y	P <sub>B</sub>	P <sub>R</sub>
Video output ports on DVD player	Y	P <sub>B</sub>	P <sub>R</sub>
	Y	B-Y	R-Y
	Y	C <sub>b</sub>	C <sub>r</sub>
	Y	P <sub>b</sub>	P <sub>r</sub>

# EXTERNAL EQUIPMENT SETUP

## Composite (RCA) Connection

### 1. How to connect

- 1 Connect the **AUDIO/VIDEO** jacks between TV and DVD. Match the jack colors (Video = yellow, Audio Left = white, and Audio Right = red).

### 2. How to use

- Turn on the DVD player, insert a DVD.
- Select the or **AV1** input source on the TV using the **INPUT** button on the remote control.
- If connected to **AV IN 2**, select **AV2** input source on the TV.
- Refer to the DVD player's manual for operating instructions.

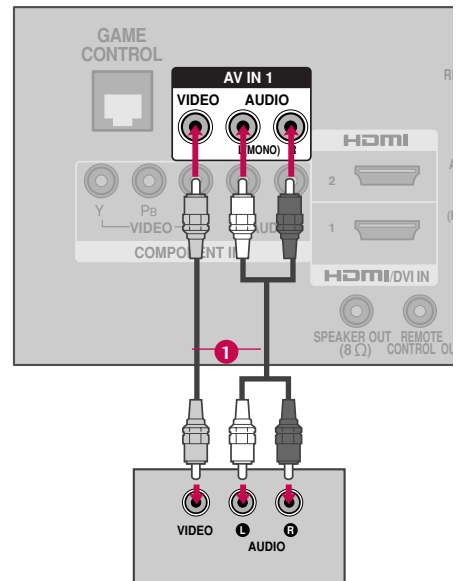

## HDMI Connection

### 1. How to connect

- 1 Connect the HDMI output of the DVD to the **HDMI/DVI IN 1** or **HDMI 2** jack on the TV.
- 2 No separate audio connection is necessary. HDMI supports both audio and video.

### 2. How to use

- Select the **HDMI1** or **HDMI2** input source on the TV using the **INPUT** button on the remote control.
- Refer to the DVD player's manual for operating instructions.

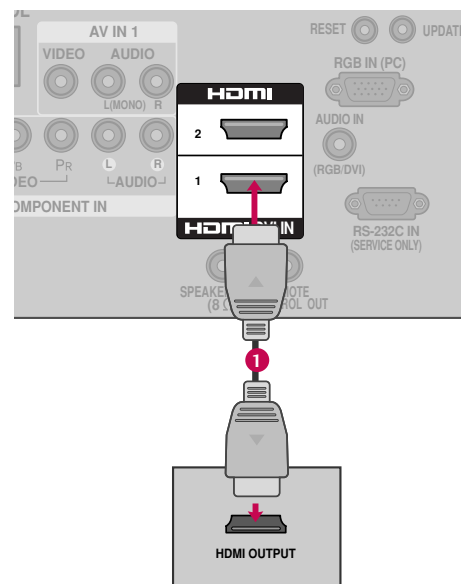

# VCR SETUP

## Antenna Connection

### 1. How to connect

- 1 Connect the RF antenna out socket of the VCR to the **ANTENNA IN** socket on the TV.
- 2 Connect the antenna cable to the RF antenna in socket of the VCR.

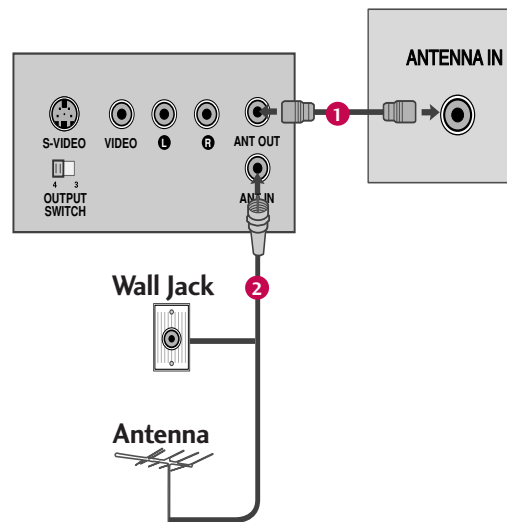

### 2. How to use

- Set VCR output switch to 3 or 4 and then tune TV to the same channel number.
- Insert a video tape into the VCR and press PLAY on the VCR. (Refer to the VCR owner's manual.)

## Composite (RCA) Connection

### 1. How to connect

- 1 Connect the **AUDIO/VIDEO** jacks between TV and VCR. Match the jack colors (Video = yellow, Audio Left = white, and Audio Right = red)

### 2. How to use

- Insert a video tape into the VCR and press PLAY on the VCR. (Refer to the VCR owner's manual.)
- Select the **AV1** input source on the TV using the **INPUT** button on the remote control.
- If connected to **AV IN 2**, select **AV2** input source on the TV.

#### NOTE

- ▶ If you have a mono VCR, connect the audio cable from the VCR to the **AUDIO (L/MONO)** jack of the TV.

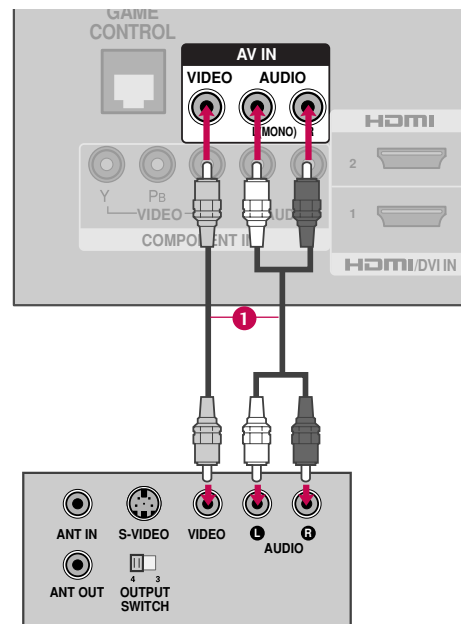

# EXTERNAL EQUIPMENT SETUP

## OTHER A/V SOURCE SETUP

### 1. How to connect

- 1 Connect the **AUDIO/VIDEO** jacks between TV and external equipment. Match the jack colors. (Video = yellow, Audio Left = white, and Audio Right = red)

### 2. How to use

- Select the **AV2** input source on the TV using the **INPUT** button on the remote control.
- If connected to **AV IN 1** input, select the **AV1** input source on the TV.
- Operate the corresponding external equipment.

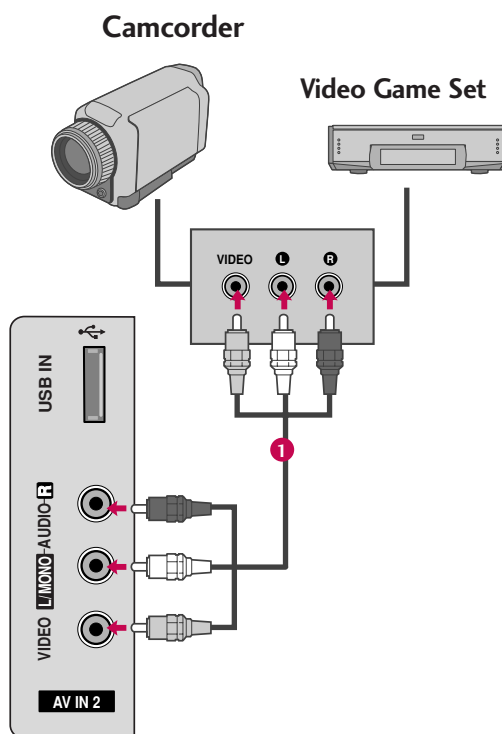

## PC SETUP

This TV provides Plug and Play capability, meaning that the PC adjusts automatically to the TV's settings.

### VGA (D-Sub 15 pin) Connection

#### 1. How to connect

- 1 Connect the VGA output of the PC to the **RGB IN (PC)** jack on the TV.
- 2 Connect the PC audio output to the **AUDIO IN (RGB/DVI)** jack on the TV.

#### 2. How to use

- Turn on the PC and the TV.
- Select the **RGB-PC** input source on the TV using the **INPUT** button on the remote control.

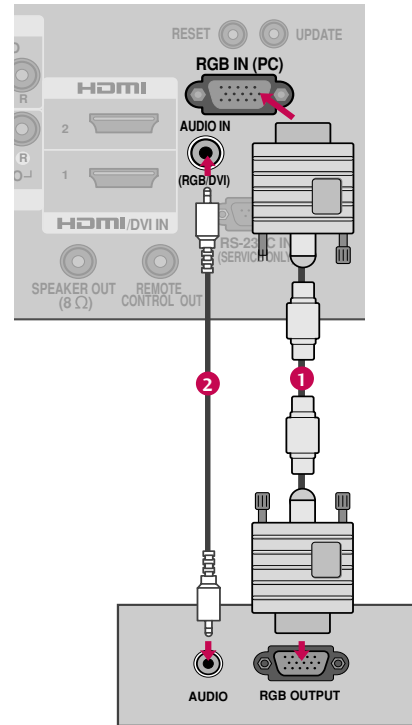

### DVI to HDMI Connection

#### 1. How to connect

- 1 Connect the DVI output of the PC to the **HDMI/DVI IN 1** jack on the TV.
- 2 Connect the PC audio output to the **AUDIO IN (RGB/DVI)** jack on the TV.

#### 2. How to use

- Turn on the PC and the TV.
- Select the **HDMI1** input source on the TV using the **INPUT** button on the remote control.

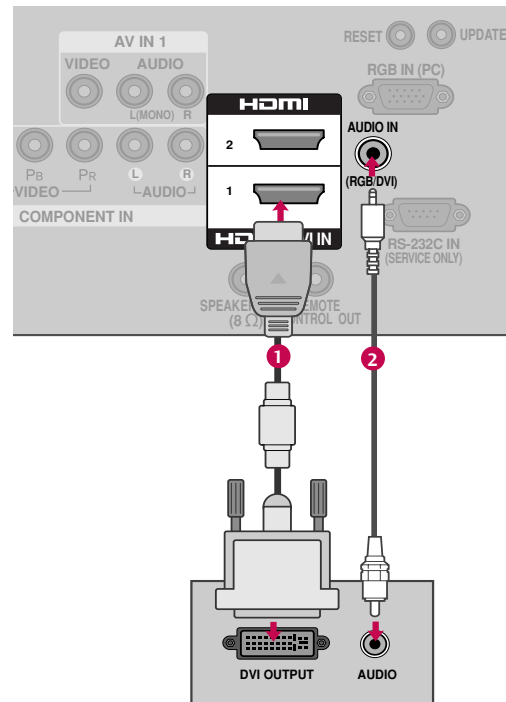

# EXTERNAL EQUIPMENT SETUP

## Supported Display Specifications (RGB-PC, HDMI-PC)

For 32LH240H, 32/37/42LH250H,  
32/37/42LH255H

Resolution	Horizontal Frequency(KHz)	Vertical Frequency(Hz)
640x350 RGB-PC	31.469	70.08
720x400 RGB-PC	31.469	70.08
640x480 RGB-PC	31.469	59.94
800x600	37.879	60.31
1024x768	48.363	60.00
1280x768	47.776	59.87
1360x768	47.720	59.799
1366x768	47.13	59.65

For 37/42LH260H, 37LH265H

Resolution	Horizontal Frequency(KHz)	Vertical Frequency(Hz)
640x480 RGB-PC	31.469	59.9
800x600	35.156	56.25
	37.879	60.31
1024x768	48.363	60.00
1024x768 RGB-PC	56.476	70.06
1280x768	47.776	59.870
1360x768	47.712	60.015
1280x1024	63.981	60.020
1600x1200	75.00	60.00
1920x1080 RGB-PC	66.587	59.934

### ! NOTES









- ▶ To get the best picture quality, adjust the PC graphics card to 1920x1080(For 37/42LH260H, 37LH265H), 1360x768(The others).
- ▶ Depending on the graphics card, DOS mode may not work if a HDMI to DVI Cable is in use.
- ▶ In PC mode, there may be noise associated with the resolution, vertical pattern, contrast or brightness. If noise is present, change the PC output to another resolution, change the refresh rate to another rate or adjust the brightness and contrast on the PICTURE menu until the picture is clear.  
When you use too long RGB-PC cable, there might be a noise on the screen.
- ▶ Avoid keeping a fixed image on the screen for a long period of time. The fixed image could become permanently imprinted on the screen.
- ▶ The synchronization input form for Horizontal and Vertical frequencies is separate.
- ▶ Depending on the graphics card, some resolution settings may not allow the image to be positioned on the screen properly.

## Screen Setup for PC mode

### Selecting Resolution

You can choose the resolution in RGB-PC mode.  
The **Position**, **Phase**, and **Size** can also be adjusted.











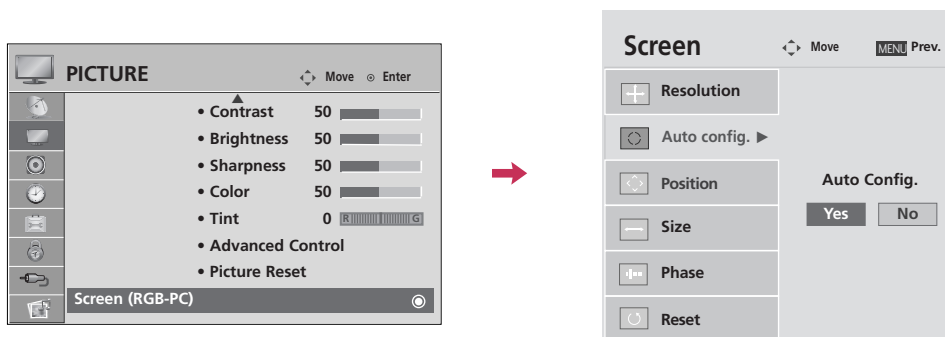

- 1   Select **PICTURE**.
- 2   Select **Screen (RGB-PC)**.
- 3   Select **Resolution**.
- 4   Select the desired resolution.
- 5 

# EXTERNAL EQUIPMENT SETUP

## Auto Configure

Automatically adjusts picture position and minimizes image instability. After adjustment, if the image is still not correct, try using the manual settings or a different resolution or refresh rate on the PC.



-   Select **PICTURE**.
-   Select **Screen (RGB-PC)**.
-   Select **Auto config.**
-   Select **Yes**.
-  Start Auto Configuration.

- If the position of the image is still not correct, try Auto adjustment again.
- If picture needs to be adjusted again after Auto adjustment in RGB-PC, you can adjust the **Position**, **Size** or **Phase**.









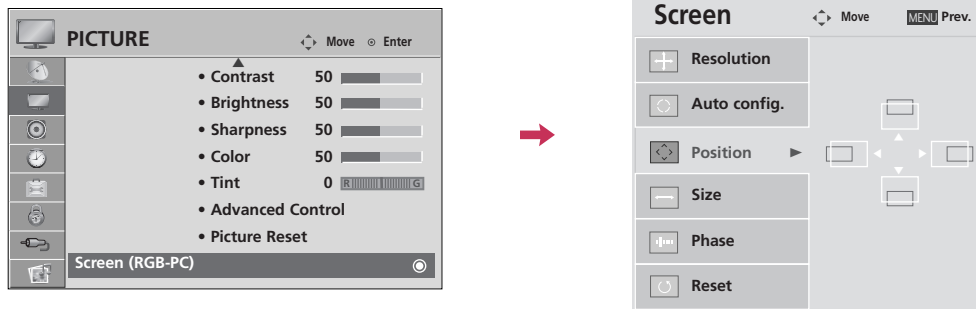

## Adjustment for screen Position, Size, and Phase

If the picture is not clear after auto adjustment and especially if characters are still trembling, adjust the picture phase manually.

This feature operates only in RGB-PC mode.



- 1   Select **PICTURE**.
- 2   Select **Screen (RGB-PC)**.
- 3   Select **Position, Size, or Phase**.
- 4   Make appropriate adjustments.
- 5 

- **Position:** This function is to adjust picture to left/right and up/down as you prefer.
- **Size:** This function is to minimize any vertical bars or stripes visible on the screen background. And the horizontal screen size will also change.
- **Phase:** This function allows you to remove any horizontal noise and clear or sharpen the image of characters.







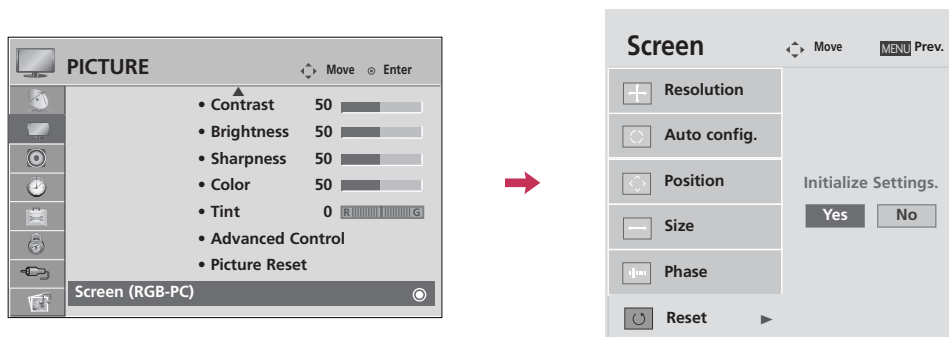

# EXTERNAL EQUIPMENT SETUP

## Screen Reset (Reset to original factory values)

Returns **Position**, **Size**, and **Phase** to the default factory settings.

This feature operates only in RGB-PC mode.



-   Select **PICTURE**.
-   Select **Screen (RGB-PC)**.
-   Select **Reset**.
-   Select **Yes**.
- 

# USB CONNECTION

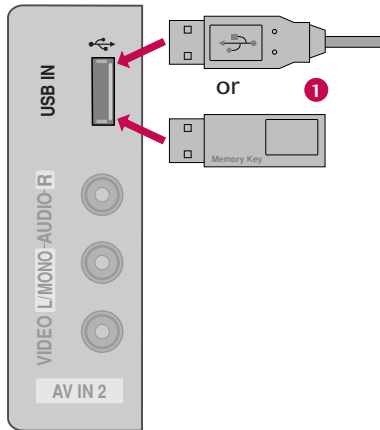

## 1. How to connect

- 1 Connect the USB device to the **USB IN** jack on the side of TV.

## 2. How to use

- After connecting the **USB IN** jack, you use the USB function. (► p.43)

# WATCHING TV / CHANNEL CONTROL

## REMOTE CONTROL FUNCTIONS

When using the remote control, aim it at the remote control sensor on the TV.

**POWER** Turns your TV or any other programmed equipment on or off, depending on mode.

**MARK** Use to mark or unmark a photo/music.

**RATIO** Change the aspect ratio.

**INPUT** Rotates through inputs.  
Also switches the TV on from standby.

**CC** Select a closed caption.

**THUMBSTICK (Up/Down/Left Right/ENTER)** Navigates the on-screen menus and adjusts the system settings to your preference.

**MENU** Displays the main menu or clears all on-screen displays and return to TV viewing.

**RETURN** Allows the user to move return one step in an interactive application or other user interaction function.

**VCR/DVD control buttons** Control video cassette recorders or DVD players.

**TIMER** Select the amount of time before your TV turns off automatically.

**ALAM** Set the time that the TV will automatically turn itself on.

**SAP** Analog mode: Selects MTS sound (Mono, Stereo, or a SAP)  
DTV mode: Changes the audio language.

**EJECT** Eject the USB device.

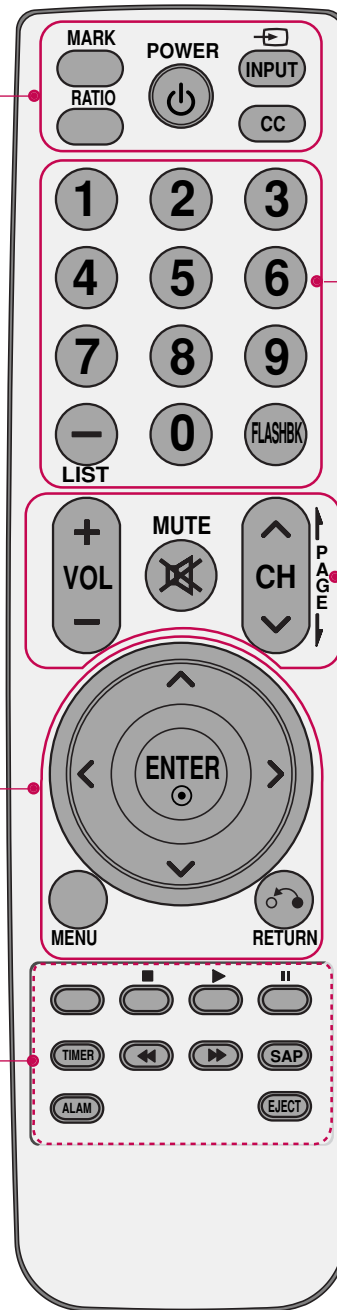

**NUMBER  
button**

— (**DASH**) Used to enter a program number for multiple program channels such as 2-1, 2-2, etc.

**LIST** Displays the channel table.

**FLASHBK** Tunes to the last channel viewed.

**VOLUME UP  
/DOWN** Increase/decrease the sound level.

**MUTE** Switch the sound on or off.

**CHANNEL  
UP/DOWN** Select available channels.

**PAGE  
UP/DOWN** Move from one full set of screen information to the next one.

## Installing Batteries

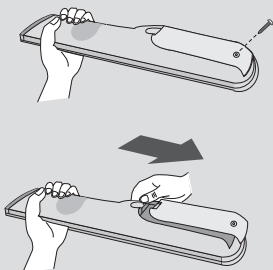

- Loosen the bolt on the battery compartment cover.
- Open the battery compartment cover on the back side and install the batteries matching correct polarity (+with +,-with -).
- Install two 1.5V AAA batteries. Don't mix old or used batteries with new ones.
- Close cover.

# WATCHING TV / CHANNEL CONTROL

## TURNING ON TV

---

- 1** First, connect power cord correctly.  
At this moment, the TV switches to standby mode.
    - In standby mode to turn TV on, press the  button on the TV or press the **POWER** button on the remote control.
  - 2** Select the viewing source by using the **INPUT** button on the remote control.
  - 3** When finished using the TV, press the **POWER** button on the remote control. The TV reverts to standby mode.
- 

### ! NOTE

- ▶ If you intend to be away on vacation, disconnect the power plug from the wall power outlet.

## CHANNEL SELECTION

---

- 1** Press the **CH**( or ) or **NUMBER** buttons to select a channel number.
- 

## VOLUME ADJUSTMENT

Adjust the volume to suit your personal preference.





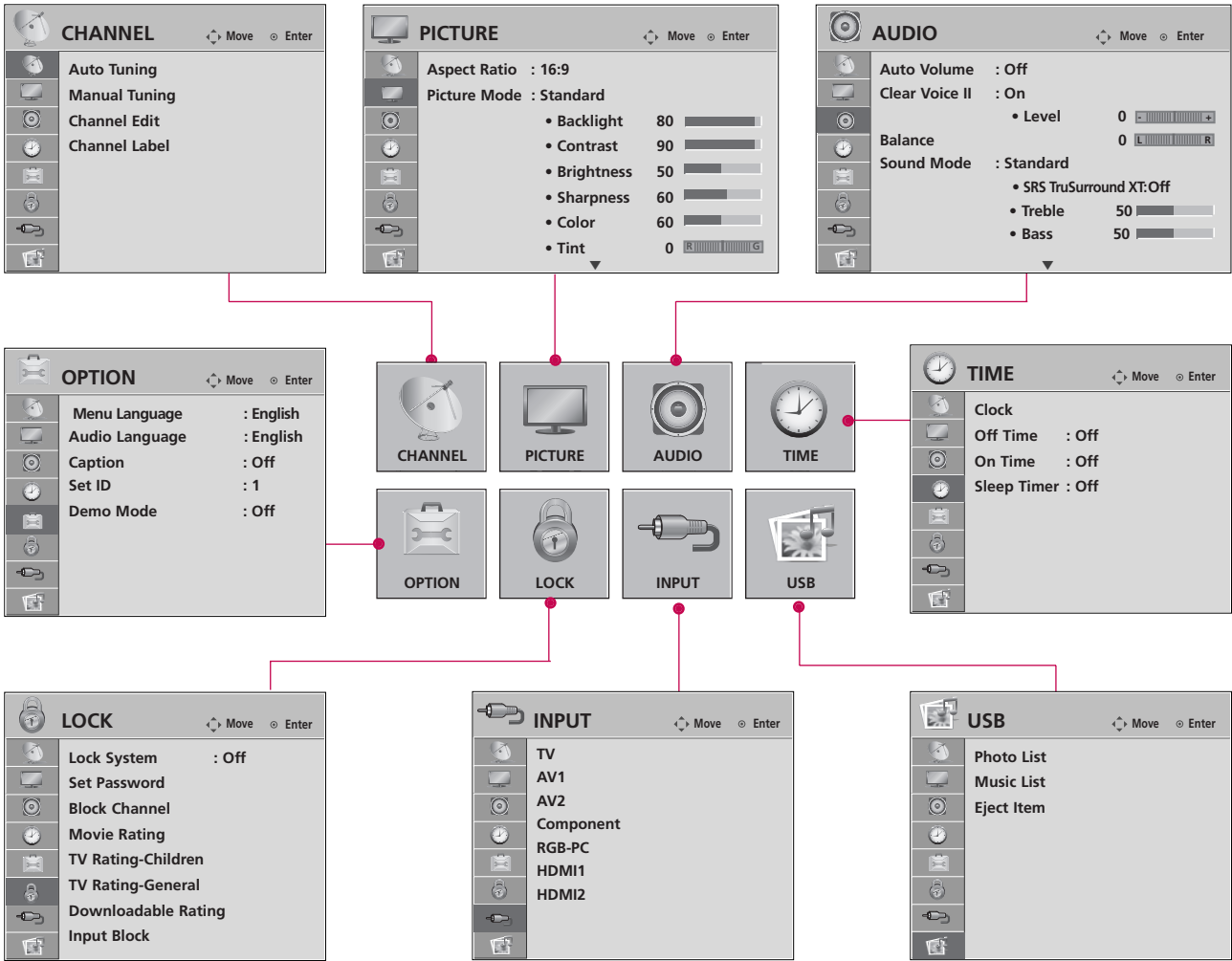

---

- 1** Press the **VOL** (**+** or **-**) button to adjust the volume.
  - 2** If you want to switch the sound off, press the **MUTE** button.
  - 3** You can cancel the Mute function by pressing the **MUTE** or **VOL** (**+** or **-**) button.
-

# ON-SCREEN MENUS SELECTION

Your TV's OSD (On Screen Display) may differ slightly from that shown in this manual.



- 1   Display each menu.
- 2   Select a menu item.
- 3  Enter to the pop up menu.
- 4  Return to TV viewing.

## CHANNEL SETUP







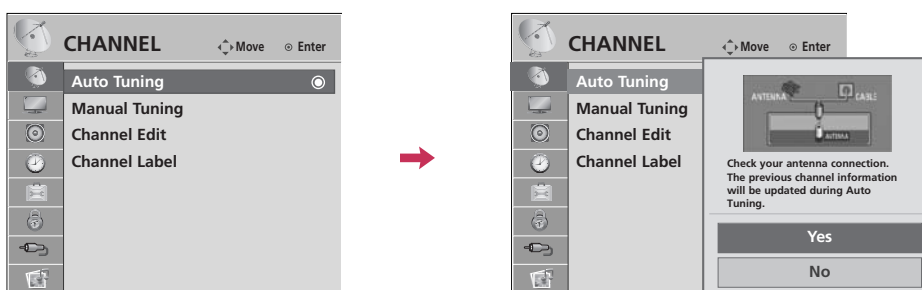

### Auto Scan (Auto Tuning)

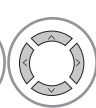
Automatically finds all channels available through antenna or cable inputs, and stores them in memory on the channel list.

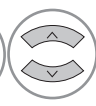
Run this function if you change your residence or move the TV. Also, make sure to run this function with the antenna connected during TV broadcasting hours.

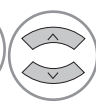
Auto Tuning memorizes only the channels available at the time.



-   Select **CHANNEL**.
-   Select **Auto Tuning**.
-   Select **Yes**.
-  Run **Auto tuning**.
-  Return to the previous menu.
-  Return to TV viewing.









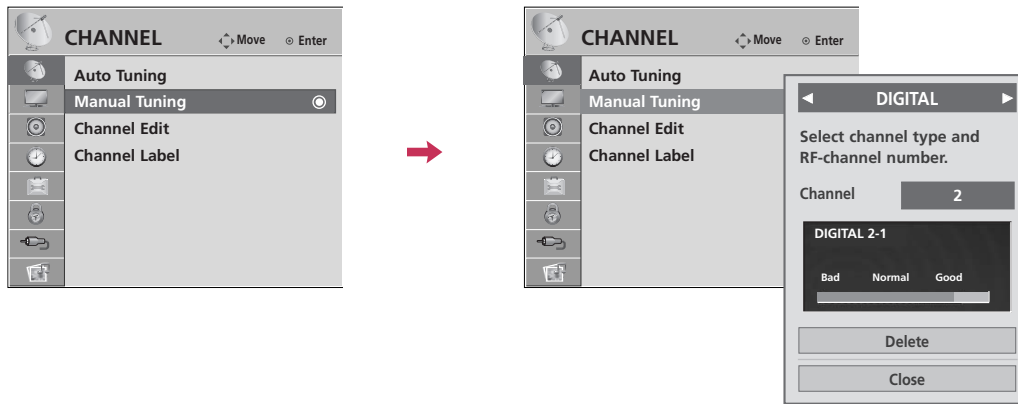



- The TV will ask for a password if parental control has been activated (LOCK Menu). Use the password you set up in the LOCK Menu to allow a channel search.
- When setting the Auto tuning or Manual tuning, the number of maximum channel you can store is 740.  
It is subject to change depending on the broadcasting signal environment.
- Automatically finds all channels available through antenna or cable inputs, and stores them in memory on the channel list.



## Add/Delete Channel (Manual Tuning)

If selecting DTV or CADTV input signal, you can view the on-screen signal strength monitor to see the quality of the signal being received.



- 1   Select **CHANNEL**.
- 2   Select **Manual Tuning**.
- 3   Select **DIGITAL** or **ANALOG**.
- 4   Select channel you want to add or delete.
- 5   Select **Add** or **Delete**.
- 6  Return to the previous menu.
-  Return to TV viewing.

- The TV will ask for a password if parental control has been activated (LOCK Menu). Use the password you set up in the LOCK Menu to allow a channel search.
- When setting the Auto tuning or Manual tuning, the number of maximum channel you can store is 1000. It is subject to change depending on the broadcasting signal environment.

# WATCHING TV / CHANNEL CONTROL

## Channel Editing

The channels in the Channel Edit List are displayed in black and the channels deleted from the Channel Edit List are displayed in blue.

When a channel number is deleted, it means that you will be unable to select it using **CH** ^ v button during TV viewing.

If you wish to select the deleted channel, directly enter the channel number with the **NUMBER** buttons or select it in the **Channel Edit** menu.

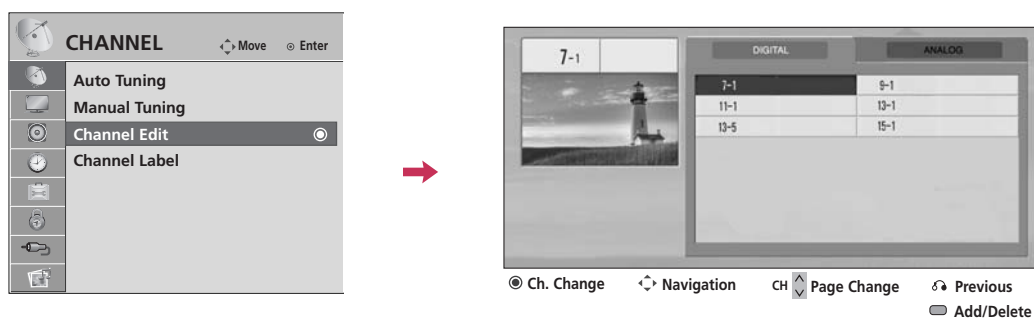









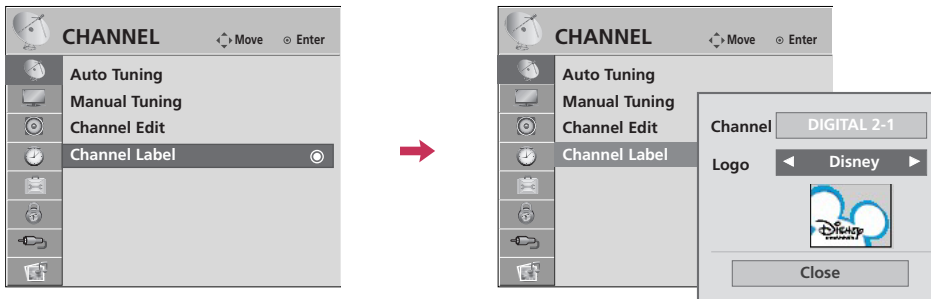



-   Select **CHANNEL**.
-   Select **Channel Edit**.
-   Select a channel.
-  Select channel you want to add or delete.
-  Return to the previous menu.
-  Return to TV viewing.

# CHANNEL LABEL

Choose preset labels for your channels.

If a channel label is provided on the signal from the broadcasting station, the TV displays a short name for a channel even if you didn't preset a label for the channel.



-   Select **CHANNEL**.
-   Select **Channel Label**.
-   Select Channel.
-  Select a channel to set logo.
-   Select the appropriate logo for the channel.
-  Return to the previous menu.
-  Return to TV viewing.

# WATCHING TV / CHANNEL CONTROL

## INPUT LIST



Select the desired input source.

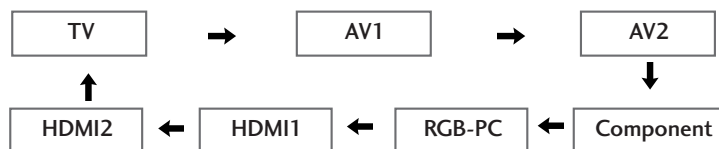

- **TV:** Select it to watch over-the-air, cable and digital cable broadcasts.
- **AV1 -2:** Select them to watch a VCR or other external equipment.
- **Component:** Select them to watch DVD or a Digital set-top box.
- **RGB-PC:** Select it to view PC input.
- **HDMI1 -2:** Select them to watch high definition devices.

# USB

- Image shown may differ from your TV.

## ENTRY MODES

When you connect a USB device, this pop up menu is displayed automatically.

When the Pop Up menu does not appear, you can select Photo List or Music List in the USB menu.

On a USB device, you can not add a new folder or delete an existing folder.

- 1 Connect the USB device to the **USB IN** jacks on the side of TV.

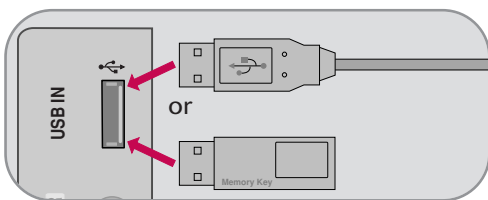

- This TV Supports on JPG and MP3.

### When removing the USB device

Press the **EJECT** button before removing the USB device.

- 2  Select **PHOTO LIST** or **MUSIC LIST**.

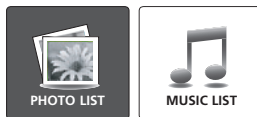

- 3 

## Precautions when using the USB device

- ▶ Only a USB storage device is recognizable.
- ▶ If the USB storage device is connected through a USB hub, the device is not recognizable.
- ▶ A USB storage device using an automatic recognition program may not be recognized.
- ▶ A USB storage device which uses its own driver may not be recognized.
- ▶ The recognition speed of a USB storage device may depend on each device.
- ▶ In case of a card reader, up to four memory cards are concurrently recognizable.
- ▶ Please do not turn off the TV or unplug the USB device when the connected USB storage device is working. When such device is suddenly separated or unplugged, the stored files or the USB storage device may be damaged.
- ▶ Only use a USB storage device which has normal music, image or movie files.
- ▶ Please connect power to a USB storage device (over 0.5A) which requires an external power supply. If not, the device may not be recognized.
- ▶ Please connect a USB storage device with cable is offered by USB maker. If connected with cable is not offered by USB maker or an excessively long cable, the device may not be recognized.
- ▶ Some USB storage devices may not be supported or operate properly.
- ▶ File alignment method of USB storage device is similar to Window XP and filename can recognize up to 100 English characters.
- ▶ Please backup important files because data on the USB device may be damaged. Data management is the consumer's responsibility and as a result, the manufacturer does not cover data damage.
- ▶ Please use only a USB storage device which was formatted as a FAT32, NTFS file system provided with the Windows operating system. In case of a storage device formatted as a different utility programme which is not supported by Windows, it may not be recognized.
- ▶ Data in a USB storage device cannot be deleted in the NTFS file system.
- ▶ If your USB memory device has multiple partitions, or if you use a USB multi-card reader, you can use up to 4 partitions or USB memory devices.
- ▶ The recommended capacity is 1 TB or less for a USB external hard disk and 32GB or less for USB memory.
- ▶ Any device with more than the recommended capacity may not work properly.
- ▶ If a USB external hard disk with a "Energy Saving" function does not work, turn the hard disk off and on again to make it work properly. Refer to the user manual of the application USB external hard disk.
- ▶ When using a USB HDD via the USB extending cable, connect a support electric power source.

# PHOTO LIST



You can only view .JPG files from USB storage devices.  
The On-Screen Display on your model may be slightly different.

## Supported photo file: \*.JPG

- You can play JPG files only.
- Only baseline scan is supported among JPG.
- Available JPG size: 64 pixel (width) x 64 pixel (height) - 15360 pixel (width) x 8640 pixel (height)



## Screen Components

**1**

Select **USB**.

**2**

Select **Photo List**.

- ① Moves to upper level folder
- ② Preview: Display the thumbnail/folder name of the photo in the selected folder
- ③ Current page/Total pages
- ④ Total number of marked photos
- ⑤ Corresponding buttons on the remote control

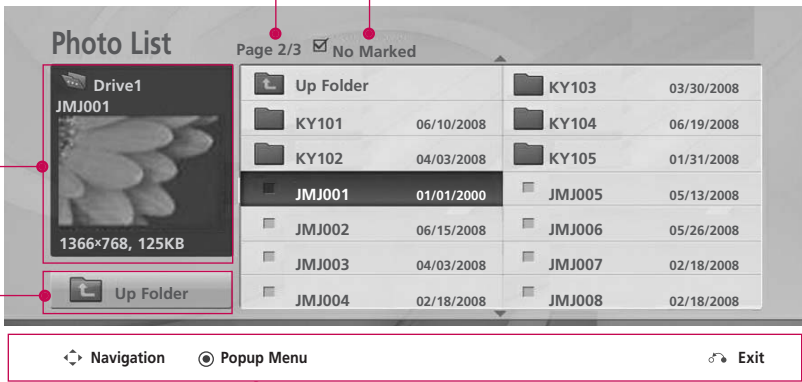

The screenshot shows a 'Photo List' interface. At the top left, a preview window shows a photo of a flower with the filename 'JM001' and dimensions '1366x768, 125KB'. Below the preview is an 'Up Folder' button. To the right is a table of folders and files. At the bottom, a navigation bar contains 'Navigation', 'Pop up Menu', and 'Exit' buttons.

Photo List		Page 2/3	<input checked="" type="checkbox"/> No Marked
Up Folder			
KY101	06/10/2008	KY103	03/30/2008
KY102	04/03/2008	KY104	06/19/2008
<b>JMJ001</b>	<b>01/01/2000</b>	KY105	01/31/2008
JMJ002	06/15/2008	JMJ005	05/13/2008
JMJ003	04/03/2008	JMJ006	05/26/2008
JMJ004	02/18/2008	JMJ007	02/18/2008
		JMJ008	02/18/2008

## Photo Selection and Popup Menu

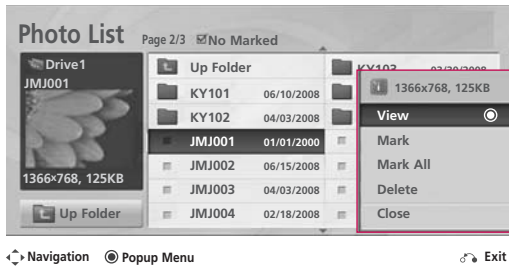
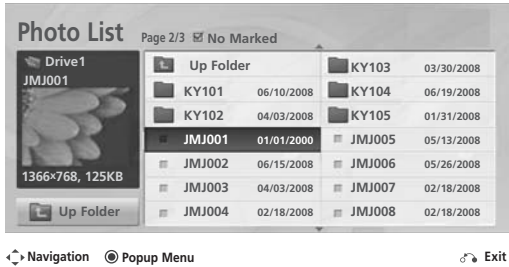

When you select a file (not folder), this PopUp menu is displayed.

- ▶ **View:** Display the selected item.
- ▶ **Mark/Unmark:** Use to mark or unmark a photo.
- ▶ **Mark All:** Mark all photos on the screen.
- ▶ **Unmark All:** Deselect all marked photos.
- ▶ **Delete or Delete Marked:** Delete the selected photo item.
- ▶ **Close:** Close the pop-up menu.

- 1 Select the target folder or drive.
- 2 Select the desired photos.
- 3 Show the Popup menu.
- 4 Select the desired Popup menu.

- Use the **CH** ^ v button to navigate in the photo page.
- Use the **MARK** button to mark or unmark a photo. When one or more photos are marked, you can view individual photos or a slide show of the marked photos. If no photos are marked, you can view all photos individually or all photos in the folder in a slide show.







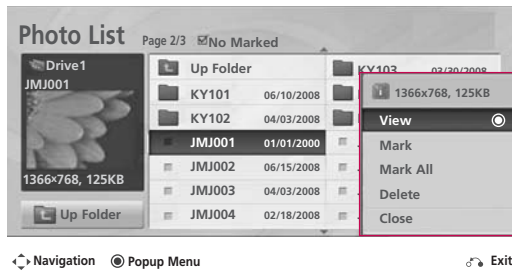
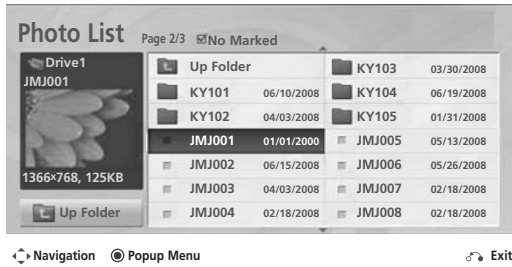

## Full Screen Menu

You can change the Photo List view so that it fills the screen. More operations are available in full screen mode.



The aspect ratio of a photo may change the size of the photo displayed on the screen in full size. Press the **RETURN** button to move to the previous menu screen.

- 1  Select the target folder or drive.
- 2   Select the desired photos.
- 3  Show the Popup menu.
- 4  Select **View**.
- 5  The selected photo is displayed in full size.

■ Use the **CH** ^ v button to navigate in the photo page.

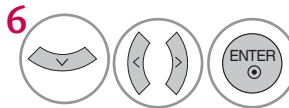

6 Select the **Slideshow**, **BGM**, **Rotate**, **Delete**, **Option**, or **Hide**.

- Use < > button to select the previous or next photo.
- Use ^ v < > button to select and control the menu on the full-sized screen.

- ▶ **Slideshow**: Selected photos are displayed during the slide show. If no photo is selected, all photos in the current folder are displayed during slide show.
  - Set the time interval of the slide show in **Option**.
- ▶ **BGM**: Listen to music while viewing photos in full size.
  - Set the BGM device and album in **Option**.
- ▶ **Rotate**: Rotate photos.
  - Rotates the photo 90°, 180°, 270°, 360° clockwise.
- ▶ **Delete**: Delete photos.
- ▶ **Option**: Set values for **Slide Speed** and **Music Album**.
  - Use ^ v < > button and **ENTER** button to set values. Then go to **Enter** and press **ENTER** to save the settings.
  - You cannot change **Music Album** while BGM is playing.
- ▶ **Hide** : Hide the menu on the full-sized screen.
  - To see the menu again on the full-sized screen, press **ENTER** button to display.

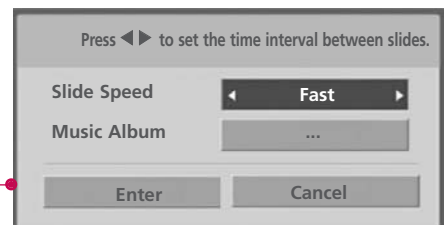

# MUSIC LIST

You can use the Music List menu to play MP3 files from a USB storage device.

This TV cannot play back copy-protected files.

The On-Screen Display on your model may be slightly different.

## Supported music file: \*.MP3

Bit rate range 32 Kbps - 320 Kbps

- Sampling rate (Sampling Frequency)

MPEG1 layer 3: 32 kHz, 44.1 kHz, 48 kHz

MPEG2 layer 3: 16 kHz, 22.05 kHz, 24 kHz

MPEG2.5 layer 3: 8 kHz, 11.025 kHz, 12 kHz

USB

## Screen Components







- 1 Moves to upper level folder
- 2 Preview: If any album jacket for the file exists, this jacket is displayed.
- 3 Current page/Total pages
- 4 Total number of marked musics
- 5 Corresponding buttons on the remote control

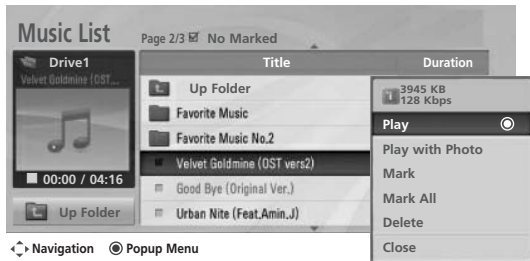

## Music Selection and Popup Menu

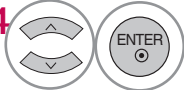

- ▶ **Play** (During stop): Play the selected file. Once a song finishes playing, the next selected one will be played. When there are no selected files to play, the next one in the current folder will be played. If you go to a different folder and press the **ENTER** button, the current song in playback will stop.
- ▶ **Play Marked**: Play the selected files. Once a file finishes playing, the next selected one will be played automatically.
- ▶ **Stop Play** (During playback): Stop the playing files.
- ▶ **Play with Photo**: Start playing the selected files and then move to the Photo List.
- ▶ **Mark/Unmark**: Use to mark or unmark a music.
- ▶ **Mark All**: Mark all files in the folder.
- ▶ **Unmark All**: Deselect all marked files.
- ▶ **Delete or Delete Marked**: Delete the selected files.
- ▶ **Close**: Close the pop-up menu.



- 1  Select the target folder or drive.
- 2  Select the desired musics.
- 3  Show the Popup menu.
- 4  Select the desired Popup menu.
- 5  Return to TV viewing.

- Use the **CH** ^ v button to navigate in the music page.
- Use the **MARK** button to mark or unmark a music file. If no music is marked, all the music in the folder will be played in sequence. When one or more music files are marked, the marked music files will be played in sequence. If you want to listen to only one song repeatedly, just mark that one file and play.

- The play information box (as shown below) will automatically move across the screen when there is no user input to prevent a fixed image remaining on the screen for an extended period of time.



### ! NOTE

- ▶ When music is playing,  is displayed in front of the music play time.
- ▶ A damaged or corrupted music file that does not play displays 00:00 as the play time.
- ▶ A music downloaded from a paid service with copyright protection does not start but displays inappropriate information in playtime.
- ▶ Press **ENTER**,  or **RETURN** button to stop the screen saver.

# PICTURE CONTROL

## PICTURE SIZE (ASPECT RATIO) CONTROL

This feature lets you choose the way an analog picture with a 4:3 aspect ratio is displayed on your TV.

- RGB-PC input source use 4:3 or 16:9 aspect ratio.

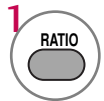
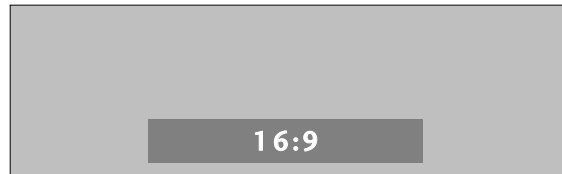

Press the **RATIO** button repeatedly to select the picture options : **Set By Program, 4:3, 16:9, Zoom, Just Scan.**



Return to TV viewing.

- You can also adjust **Aspect Ratio** in the **PICTURE** menu.

### Set by program

Selects the proper picture proportion to match the source's image.

(4:3 → 4:3)



(16:9 → 16:9)



### 4:3

Choose 4:3 when you want to view a picture with an original 4:3 aspect ratio.



### 16:9

Adjust the picture horizontally, in a linear proportion to fill the entire screen.



### Zoom

Choose Zoom when you want to view the picture without any alteration. However, the top and bottom portions of the picture will be cropped.

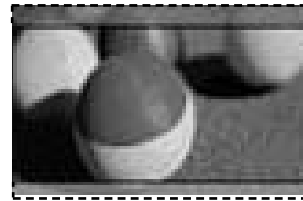

### Just Scan

Normally the edges of video signals are cropped 1-2%. Just Scan turns off this cropping and shows the complete video.

Notes: If there is noise on the edges of the original signal, it will be visible when Just Scan is activated.

**Just Scan** operates only with DTV/CADTV/HDMI-DTV/DVI-DTV (720p/1080i/1080p), Component(720p/1080i) input sources.









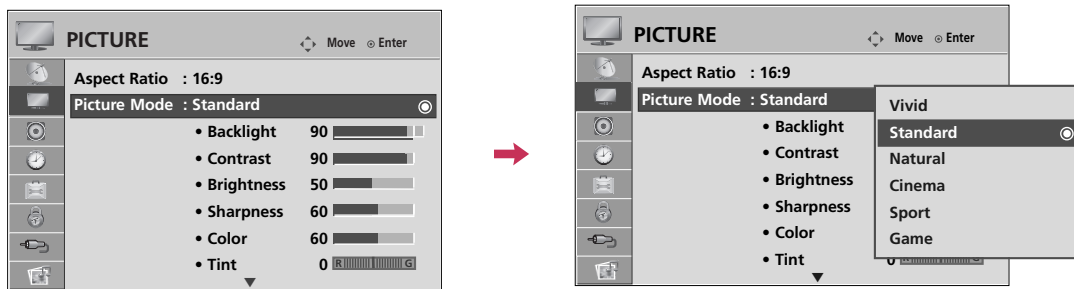

# PICTURE CONTROL

## PRESET PICTURE SETTINGS

### Picture Mode - Preset

There are factory presets for picture settings available in the user menus. You can use a preset, change each setting manually.



-   Select **PICTURE**.
-   Select **Picture Mode**.
-   Select **Vivid, Standard, Natural, Cinema, Sport or Game**.
-  Return to the previous menu.
-  Return to TV viewing.







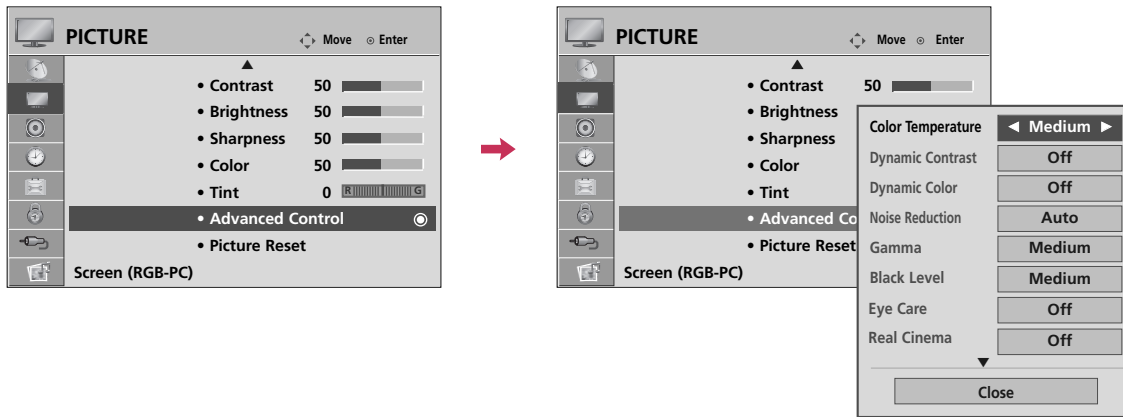

- **Vivid, Standard, Natural, Cinema, Sport, and Game** Settings are preset for the optimum picture quality at the factory and are not adjustable.
- **Vivid:** This is the mode to maximize the effect of the video in the retail store. Strengthen the contrast, brightness, color and sharpness for vivid picture.
- **Standard:** This is the mode to realize optimum viewing condition for the general user.
- **Natural:** This is the mode to display the most natural screen status.
- **Cinema:** This mode optimizes video for watching movies.
- **Sport:** This is the video mode to emphasize dynamic video and primary color (e.g, white, uniform, grass, sky blue etc.) by realizing the optimal screen for sports.
- **Game:** This is the mode to realize fast response speed in a fast gaming screen.



## Color Tone - Preset

Choose one of three automatic color adjustments. Set to warm to enhance hotter colors such as red, or set to cool to see less intense colors with more blue.











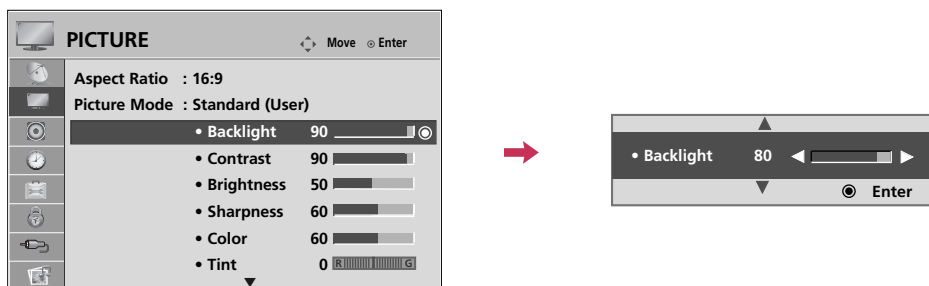



-   Select **PICTURE**.
-   Select **Advanced Control**.
-   Select **Color Temperature**.
-  Select your desired options.
-  Return to the previous menu.
-  Return to TV viewing.

# PICTURE CONTROL

## MANUAL PICTURE ADJUSTMENT - USER MODE

Adjust the picture appearance to suit your preference and viewing situations.



-   Select **PICTURE**.
-   Select **Picture Mode**.
-   Select **Vivid, Standard, Natural, Cinema, Sport or Game**.
-   Select **Backlight, Contrast, Brightness, Sharpness, Color, or Tint**.
-   Make appropriate adjustments.
-  Return to the previous menu.
-  Return to TV viewing.

# PICTURE IMPROVEMENT TECHNOLOGY

**Dynamic Contrast:** Optimizes the contrast automatically according to the brightness of the reflection.

**Dynamic Color:** Adjusts the color of the reflection automatically to reproduce as close as possible natural colors.

**Noise Reduction:** Removes interference up to the point where it does not damage the original picture.







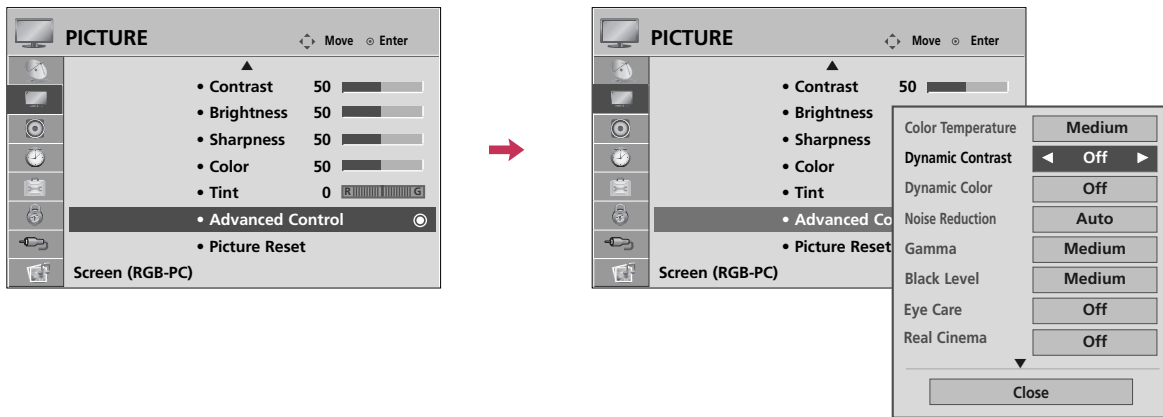

**Gamma:** High gamma values display whitish images and low gamma values display high contrast images.

**Color Gamut:** Maximize the utilization of color to increase color quality.

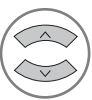
**Edge Enhancer:** Show clearer and distinctive yet natural edges in of the video. This function is enabled in **"Picture Mode - Cinema"**.

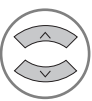
**xvYCC:** This is the function to express richer color. This feature represents rich color as much as conventional video signal. This function is enabled in **"Picture mode - Cinema"** when xvYCC signal is inputted through HDMI.



- 1   Select **PICTURE**.
- 2   Select **Advanced Control**.
- 3   Select **Dynamic Contrast, Dynamic Color, Noise Reduction, Gamma, Color Gamut, Edge Enhancer, or xvYcc**.
- 4  Select your desired options.
- 5  Return to the previous menu.
-  Return to TV viewing.









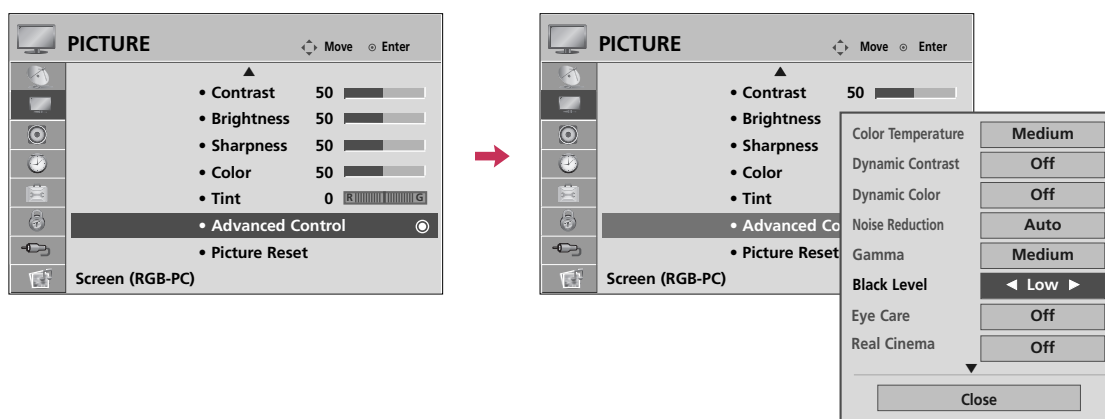

# PICTURE CONTROL

## ADVANCED CONTROL - BLACK (DARKNESS) LEVEL

Adjusting the contrast and the brightness of the screen using the black level of the screen.

This function enables to select 'Low' or 'High' in the following mode: AV (NTSC-M), HDMI or Component. Otherwise, 'Black level' is set to 'Auto'.



-   Select **PICTURE**.
-   Select **Advanced Control**.
-   Select **Black Level**.
-   Select **Low** or **High**.
-  Return to the previous menu.
-  Return to TV viewing.









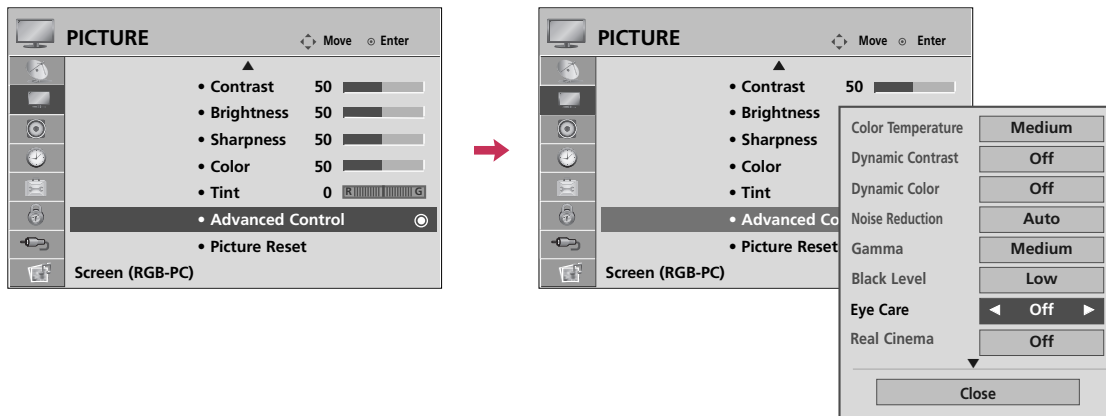

- **Low:** The reflection of the screen gets darker.
- **High:** The reflection of the screen gets brighter.

# ADVANCED CONTROL - EYE CARE

Dims extremely bright pictures.

This feature is disabled in "Picture Mode-Vivid, Cinema".



- 1   Select **PICTURE**.
- 2   Select **Advanced Control**.
- 3   Select **Eye Care**.
- 4   Select **On** or **Off**.
- 5  Return to the previous menu.
-  Return to TV viewing.

# PICTURE CONTROL









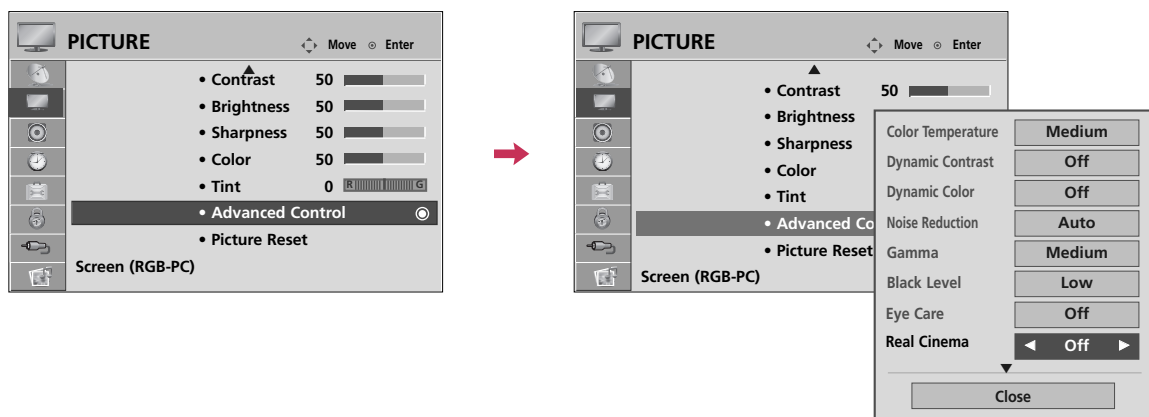

## ADVANCED CONTROL - REAL CINEMA

Set up the TV for the best picture appearance for viewing movies.

When you operate Real Cinema (3:2 Pull-Down Mode or Cinema Correction Mode), the TV will adjust 24 fps video from movies to 30 fps video for display.

This feature operates only in TV (Analog TV, Digital DTV), AV1, AV2, Component 480i/1080i, and HDMI 1080i mode.







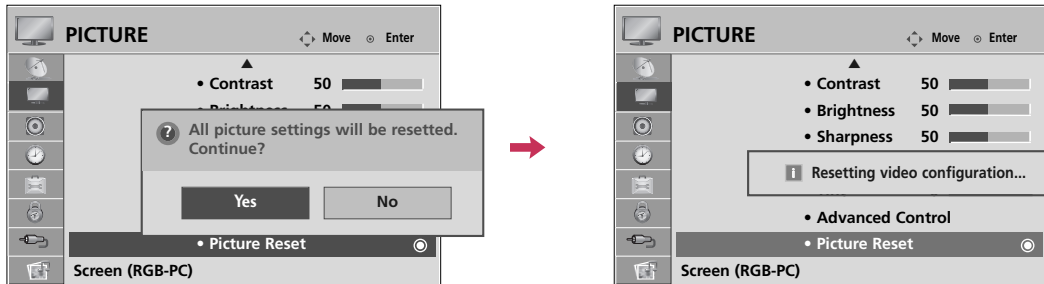

-   Select **PICTURE**.
-   Select **Advanced Control**.
-   Select **Real Cinema**.
-   Select **On** or **Off**.
-  Return to the previous menu.
-  Return to TV viewing.

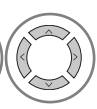
# PICTURE RESET

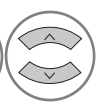
Settings of the selected picture modes return to the default factory settings.







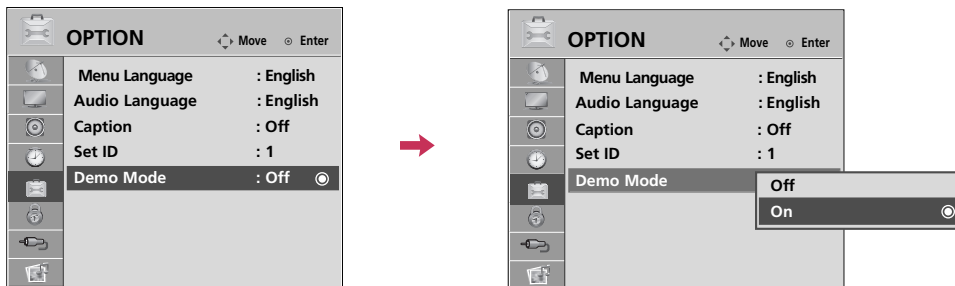

- 1   Select **PICTURE**.
- 2   Select **Picture Reset**.
- 3   Select **Yes**.
- 4  Initialize the adjusted value.
- 5  Return to TV viewing.

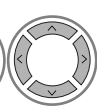
# DEMO MODE

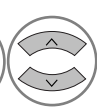
Displays a slide show to explain the various feature of this TV.

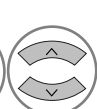

- 1   Select **OPTION**.
- 2   Select **Demo Mode**.
- 3   Select **On** to show the various feature of the TV.
- 4  Return to TV viewing.  
After a while, **Demo Mode** starts.  
If you want to stop the demo, press any button (Except VOL +, - and MUTE button).







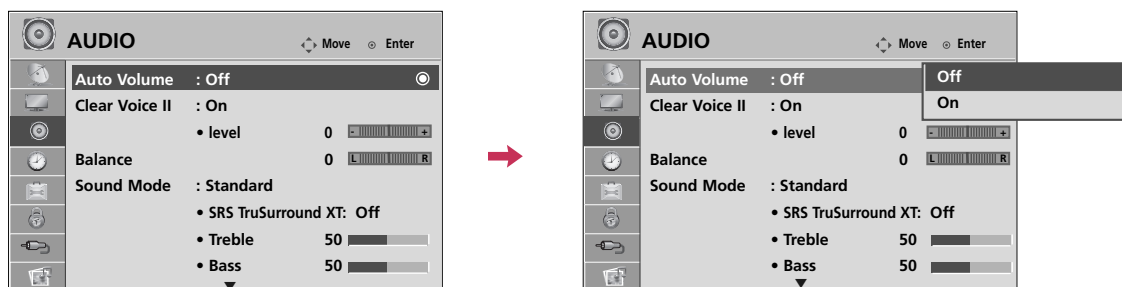

# SOUND & LANGUAGE CONTROL

## AUTO VOLUME LEVELER (AUTO VOLUME)

Auto Volume makes sure that the volume level remains consistent whether you are watching a commercial or a regular TV program.

Because each broadcasting station has its own signal conditions, volume adjustment may be needed every time the channel is changed. This feature allows users to enjoy stable volume levels by making automatic adjustments for each program.









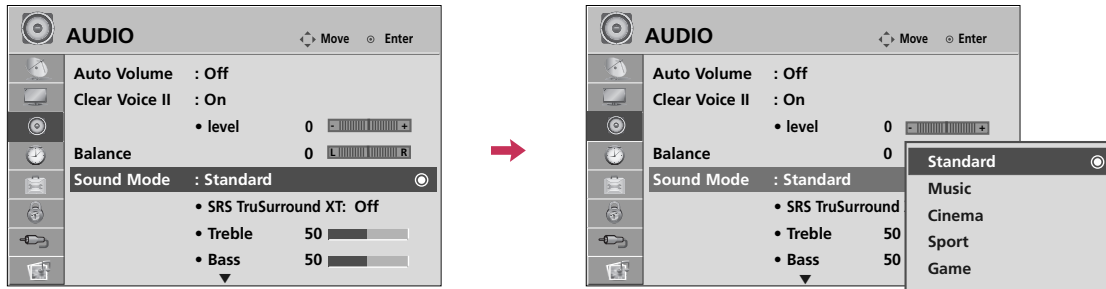

-   Select **AUDIO**.
-   Select **Auto Volume**.
-   Select **On** or **Off**.
-  Return to the previous menu.
-  Return to TV viewing.

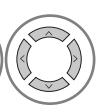

## PRESET SOUND SETTINGS (SOUND MODE)

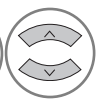
Sound Mode lets you enjoy the best sound without any special adjustment as the TV sets the appropriate sound options based on the program content.

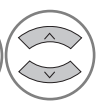

-   Select **AUDIO**.
-   Select **Sound Mode**.
-   Select **Standard, Music, Cinema, Sport, or Game**.
-  Return to the previous menu.
-  Return to TV viewing.









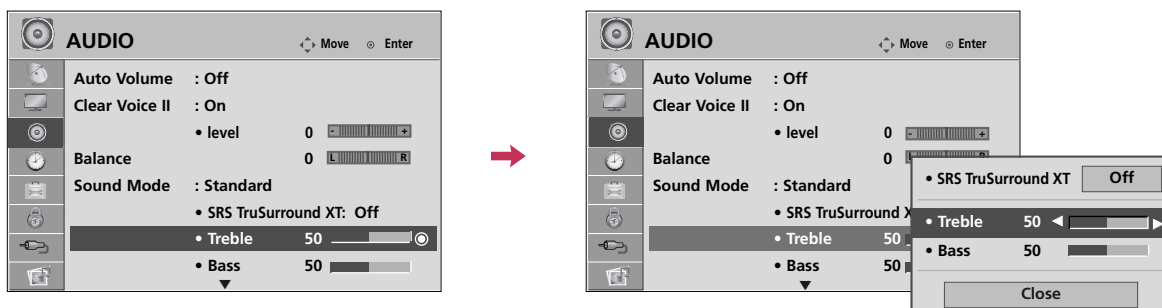



- **Standard, Music, Cinema, Sport, and Game** are preset for optimum sound quality at the factory.
- **Standard:** Offers standard-quality sound.
- **Music:** Optimizes sound for listening to music.
- **Cinema:** Optimizes sound for watching movies.
- **Sport:** Optimizes sound for watching sports events.
- **Game:** Optimizes sound for playing games.

# SOUND & LANGUAGE CONTROL

## SOUND SETTING ADJUSTMENT - USER MODE

Adjust the sound to suit your taste and room situations.







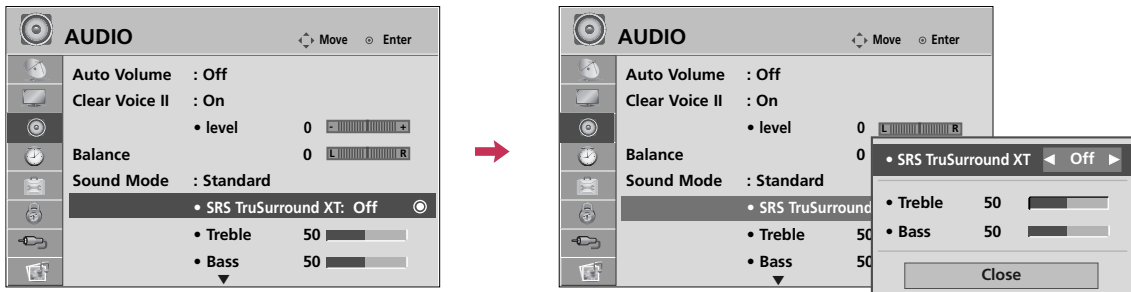

-   Select **AUDIO**.
-   Select **Sound Mode**.
-   Select **Standard, Music, Cinema, Sport, or Game**.
-   Select **Treble** or **Bass**.
-   Make appropriate adjustments.
-  Return to the previous menu.
-  Return to TV viewing.

- If sound quality or volume is not at the level you want, it is recommended to use a separate home theater system or amp to cope with different user environments.
- If you select “**Clear Voice II-On**”, **SRS TruSurround XT** feature will not work.

## SRS TRUSURROUND XT

TruSurround XT is a patented SRS technology that solves the problem of playing 5.1 multichannel content over two speakers.







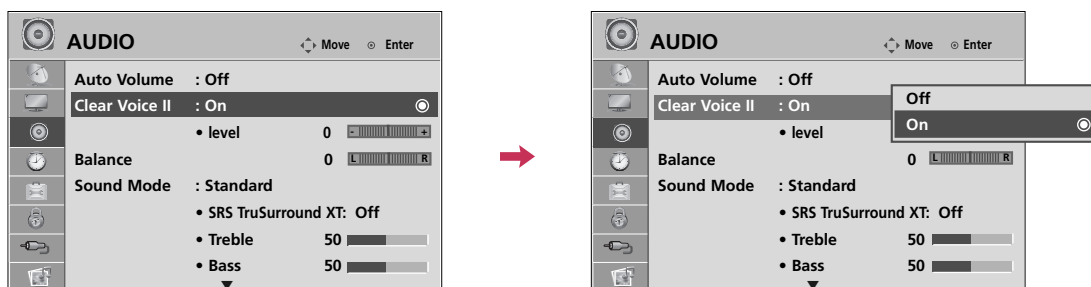

-   Select **AUDIO**.
-   Select **SRS TruSurround XT**.
-   Select **On** or **Off**.
-  Return to the previous menu.
-  Return to TV viewing.

# SOUND & LANGUAGE CONTROL





## CLEAR VOICE II

By differentiating the human sound range from others, it improves the sound quality of voices.



-   Select **AUDIO**.
-   Select **Clear Voice II**.
-   Select **On** or **Off**.



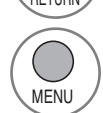

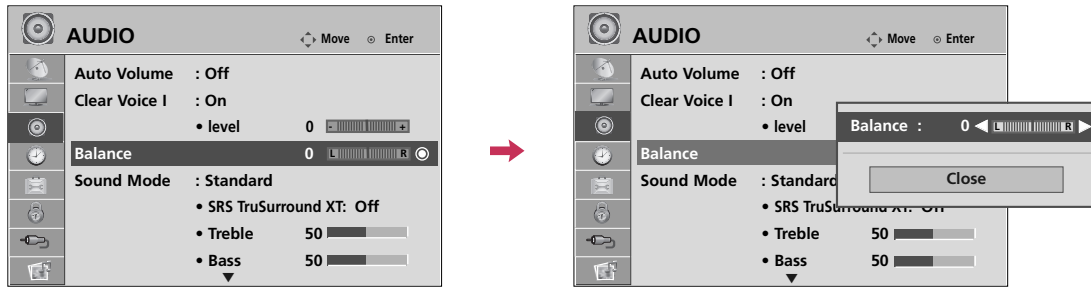

### Adjustment for Clear Voice Level With selecting **On**

-   Select **Level**.
-   Make appropriate adjustments.
-  Return to the previous menu.
-  Return to TV viewing.

# BALANCE

Adjust the left/right sound of speaker to suit your taste and room situations.



-   Select **AUDIO**.
-   Select **Balance**.
-   Make appropriate adjustments.
-  Return to the previous menu.
-  Return to TV viewing.

# SOUND & LANGUAGE CONTROL





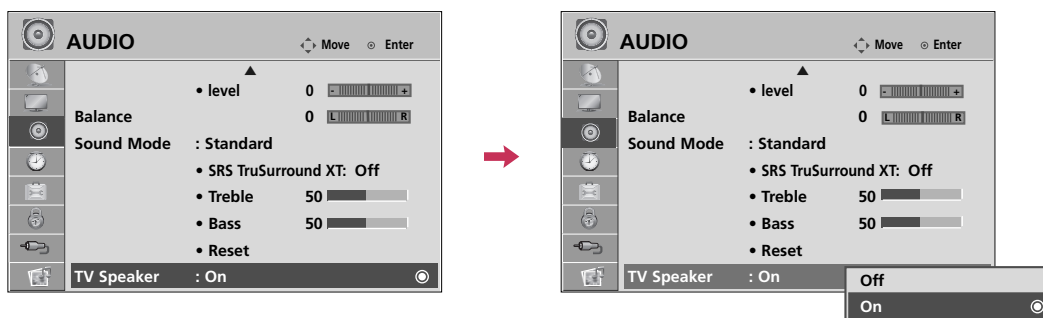

## TV SPEAKERS ON/OFF SETUP

Turn the TV speakers off if using external audio equipment.

In **AV**, **Component**, **RGB** and **HDMI** with HDMI to DVI cable, the TV speaker can be operational even when there is no video signal.

If you wish to use an external Hi-Fi system or a SRS System, turn off the TV's internal speakers.





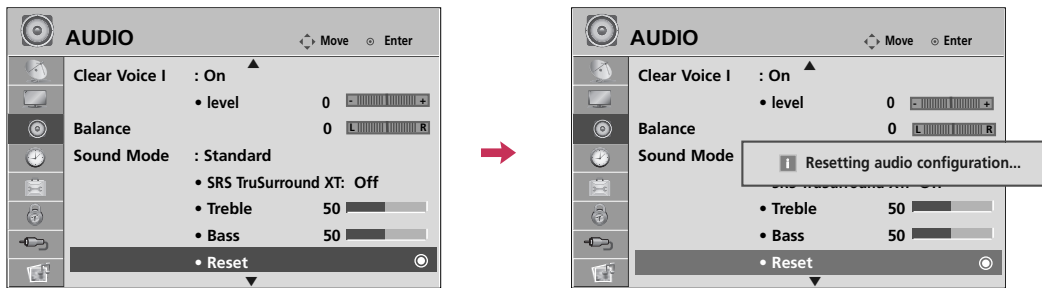

-   Select **AUDIO**.
-   Select **TV Speaker**.
-   Select **On** or **Off**.
-  Return to the previous menu.
-  Return to TV viewing.

# AUDIO RESET

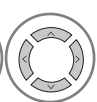
Settings of the selected Sound Mode return to the default factory settings.

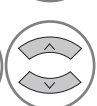



-   Select **AUDIO**.
-   Select **Reset**.
-  Initialize the adjusted value.
-  Return to TV viewing.

# SOUND & LANGUAGE CONTROL

## STEREO/SAP BROADCAST SETUP

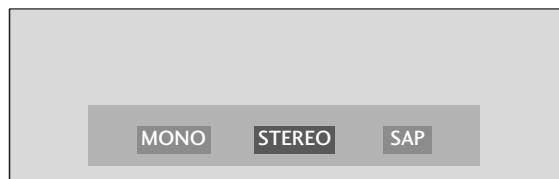
For Analog only: This TV can receive MTS stereo programs and any SAP (Secondary Audio Program) that accompanies the stereo program if the station transmits an additional sound signal. Mono sound is automatically used if the broadcast is only in Mono.



**1**  Each time you press the **SAP** button, **Mono, Stereo, or SAP** appear in turn.

**2**  Return to TV viewing.







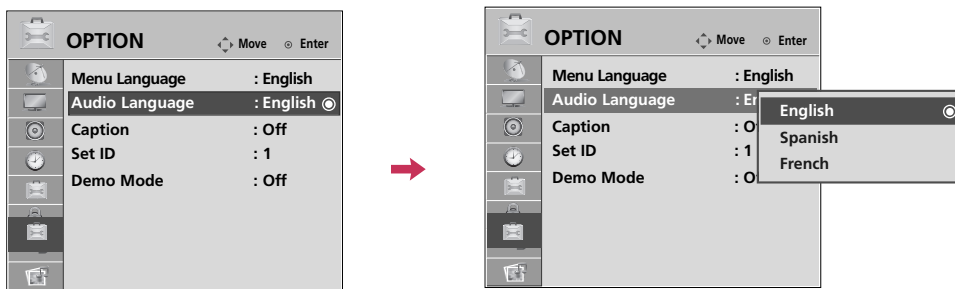

■ If other languages available on the digital signal, select them with the **SAP** button.



# AUDIO LANGUAGE

Other languages may be available if a digital signal is provided by the broadcasting station.  
This feature operates only in DTV mode.









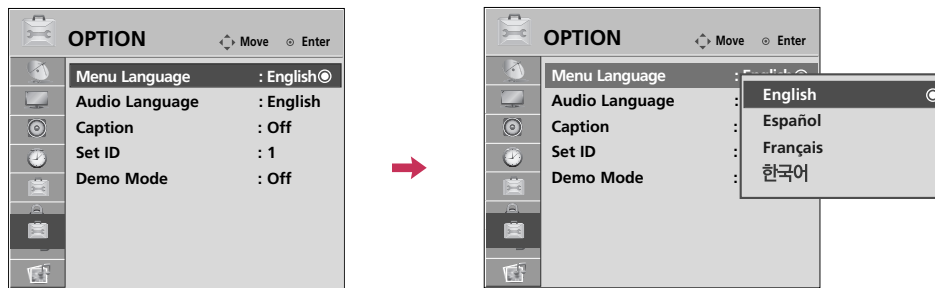

-   Select **OPTION**.
-   Select **Audio Language**.
-   Select your desired language.
-  Return to the previous menu.
-  Return to TV viewing.

# SOUND & LANGUAGE CONTROL

## ON-SCREEN MENUS LANGUAGE SELECTION

The menus can be shown on the screen in the selected language.



-   Select **OPTION**.
-   Select **Menu Language**.
-   Select your desired language.  
From this point on, the on-screen menus will be shown in the selected language.
-  Return to the previous menu.
-  Return to TV viewing.

## CAPTION MODE

Caption must be provided to help people with hearing loss watch TV.  
This feature operates only in TV, AV1-2 mode.









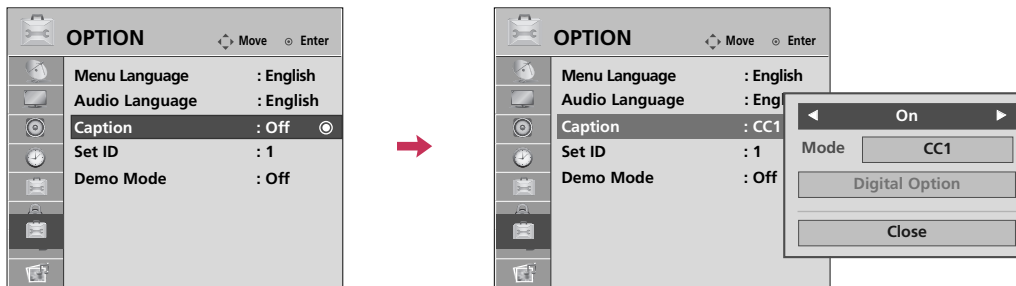

- 1  Select Caption **On** or **Off**.

- When selecting **Off**, Sub-menus for Analog, DTV, and Digital Option become disabled.

## Analog Broadcasting System Captions

Captions provided to help people with hearing loss watch TV. Select a caption mode for displaying captioning information if provided on a program. Analog caption displays information at any position on the screen and is usually the program's dialog. Caption/Text, if provided by the broadcaster, would be available for both digital and analog channels on the Antenna/Cable. This TV is programmed to memorize the caption/text mode which was last set when you turned the power off. This function is only available when **Caption Mode** is set **On**.



- 1   Select **OPTION**.
- 2   Select **Caption**.
- 3   Select **On**.
- 4   Select **CC1-4** or **Text1-4**.
- 5  Return to the previous menu.
-  Return to TV viewing.

### ■ CAPTION

The term for the words that scroll across the bottom of the TV screen; usually the audio portion of the program provided for the hearing impaired.

### ■ TEXT

The term for the words that appear in a large black frame and almost cover the entire screen; usually messages provided by the broadcaster.

# SOUND & LANGUAGE CONTROL







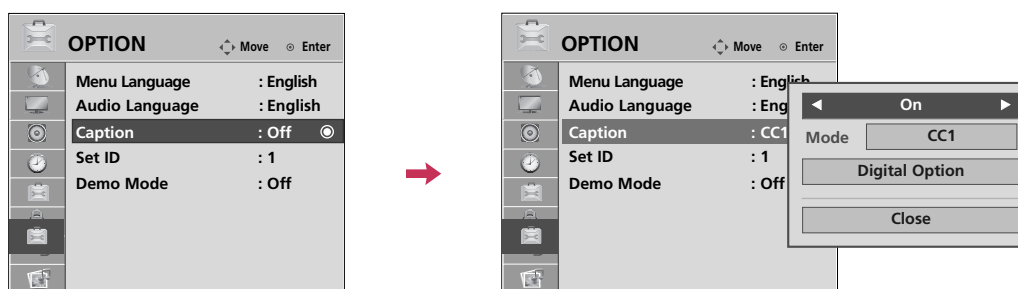

## Digital Broadcasting System Captions

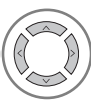
Choose the language you want the DTV Captions to appear in.

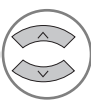
Other Languages can be chosen for digital sources only if they are included on the program.

This function is only available when **Caption Mode** is set **On**.



-   Select **OPTION**.
-   Select **Caption**.
-   Select **On**.
-   Select **CC1-4, Text1-4, or Service1 - 6**.
-  Return to the previous menu.
-  Return to TV viewing.

## Caption Option

Customize the DTV captions that appear on your screen.

This function is only available when **Caption Mode** is set **On**.

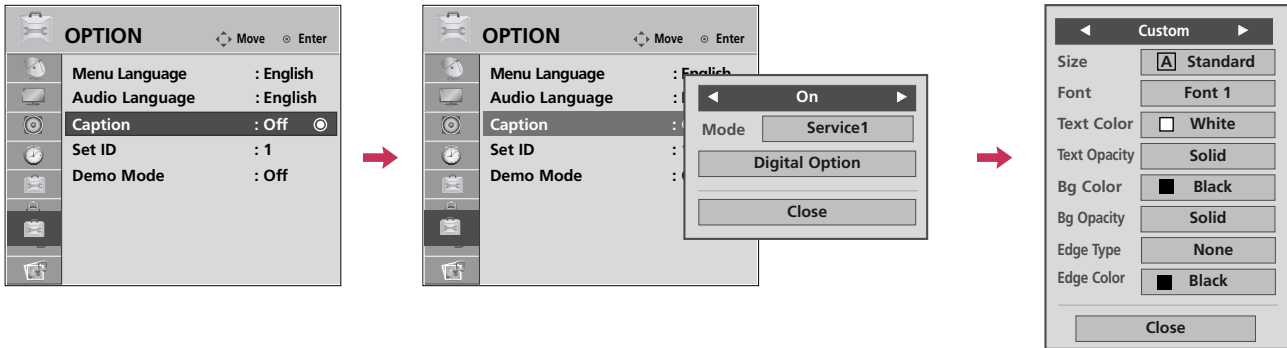



1   Select **OPTION**.

2   Select **Caption**.

3   Select **On**.

4  Select **Digital Option**.

5   Select **Custom**.

6   Customize the **Style, Font**, etc., to your preference. A preview icon is provided at the bottom of the screen, use it to see the caption language.

7  Return to the previous menu.

 Return to TV viewing.

- **Size:** Set the word size.
- **Font:** Select a typeface for the text.
- **Text Color:** Choose a color for the text.
- **Text Opacity:** Specify the opacity for the text color.
- **Bg (Background) Color:** Select a background color.
- **Bg (Background) Opacity:** Select the opacity for the background color.
- **Edge Type:** Select an edge type.
- **Edge Color:** Select a color for the edges.

# TIME SETTING

## CLOCK SETTING









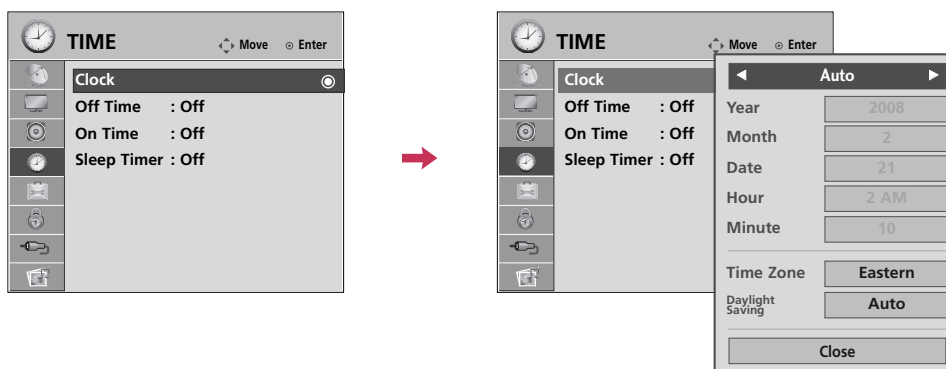



### Auto Clock Setup

The time is set automatically from a digital channel signal.

The digital channel signal includes information for the current time provided by the broadcasting station.

Set the clock manually if the current time is set incorrectly by the auto clock function.









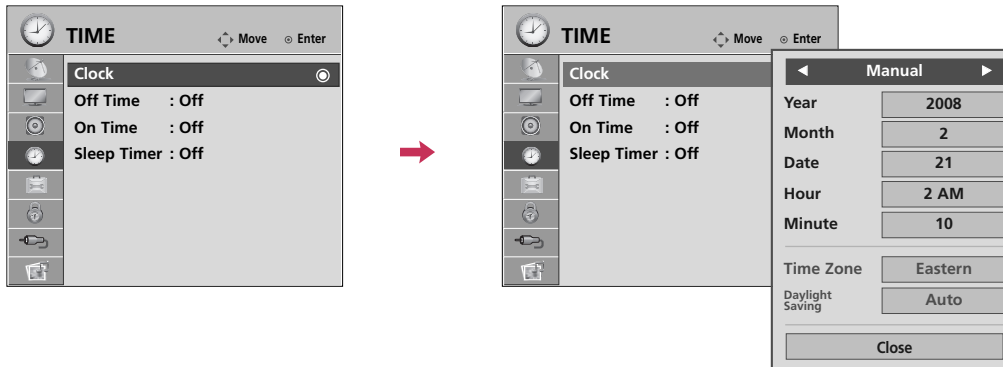



-   Select **TIME**.
-   Select **Clock**.
-   Select **Auto**.
-   Select your viewing area time zone.  
: **Eastern, Central, Mountain, Pacific, Alaska, or Hawaii.**
-   Select **Auto, Off, or On** (depending on whether or not your viewing area observes Daylight Saving time).
-  Return to the previous menu.
-  Return to TV viewing.

## Manual Clock Setup

If the current time setting is wrong, set the clock manually.



-   Select **TIME**.
-   Select **Clock**.
-   Select **Manual**.
-  Select the Year, Month, Date, Hour, or Minute option.
-  Set the Year, Month, Date, Hour, or Minute option.
-  Return to the previous menu.
-  Return to TV viewing.

# TIME SETTING

## AUTO ON/OFF TIME SETTING

This function operates only if the current time has been set.

The **Off Time** function overrides the **On Time** function if they are both set to the same time.

The TV must be in standby mode for the **On Time** to work.

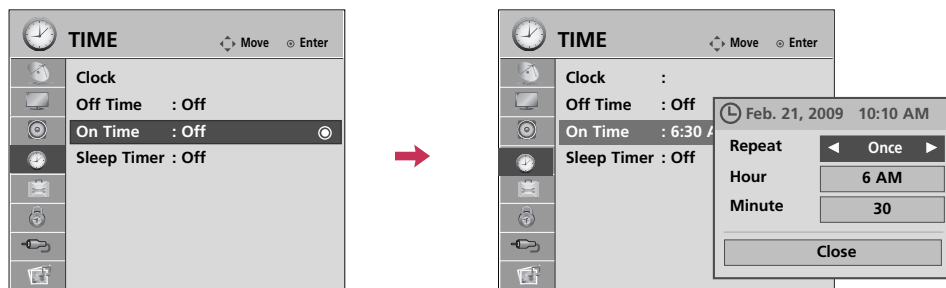

-   Select **TIME**.
-   Select **Off Time** or **On Time**.
-   Select **Repeat**.
-  Select **Off, Once, Daily, Mon.~Fri., Mon.~Sat., Sat.~ Sun., or Sun.**
-   Select and set **Hour** or **Minute**.
-  Return to the previous menu.
-  Return to TV viewing.



## SLEEP TIMER SETTING

The Sleep Time turns the TV off at the preset time.

Note that this setting is cleared when the TV is turned off.

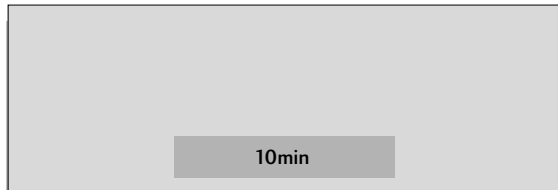

Press the **TIMER** button repeatedly to select the number of minutes.  
Sleep timer options: Off, 10, 20, 30, 60, 90, 120, 180, and 240 minutes.



Return to TV viewing.

■ You can also adjust **Sleep Timer** in the **TIME** menu.

# PARENTAL CONTROL / RATINGS

Parental Control can be used to block specific channels, ratings and other viewing sources.

The Parental Control Function (V-Chip) is used to block program viewing based on the ratings sent by the broadcasting station. The default setting is to allow all programs to be viewed. Viewing can be blocked by choosing the type of the program and the categories. It is also possible to block all program viewing for a time period. To use this function, the following must be done :

1. Set ratings and categories to be blocked.
2. Specify a password
3. Enable the lock

## V-Chip rating and categories

Rating guidelines are provided by broadcasting stations. Most television programs and television movies can be blocked by TV Rating and/or Individual Categories. Movies that have been shown at the theaters or direct-to-video movies use the Movie Rating System (MPAA) only.

## Ratings for Television programs including made-for-TV movies :

- TV-G (General audience)
- TV-PG (Parental guidance suggested)
- TV-14 (Parents strongly cautioned)
- TV-MA (Mature audience only)
- TV-Y (All children)
- TV-Y7 (Children 7 years older)

## SET PASSWORD & LOCK SYSTEM

### Setting up Your Password

Set up blocking schemes to block specific channels, ratings, and external viewing sources. A password is required to gain access to this menu.

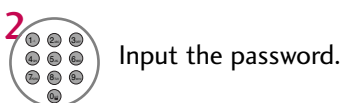
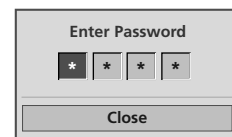
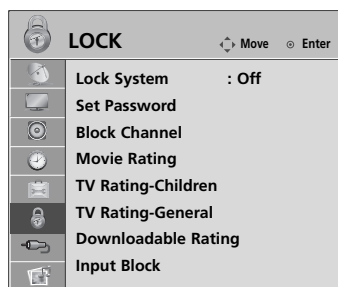

- Enter the password as requested.
- The TV is set up with the initial password "0-0-0-0".

## Lock System

Enables or disables the blocking scheme you set up previously.

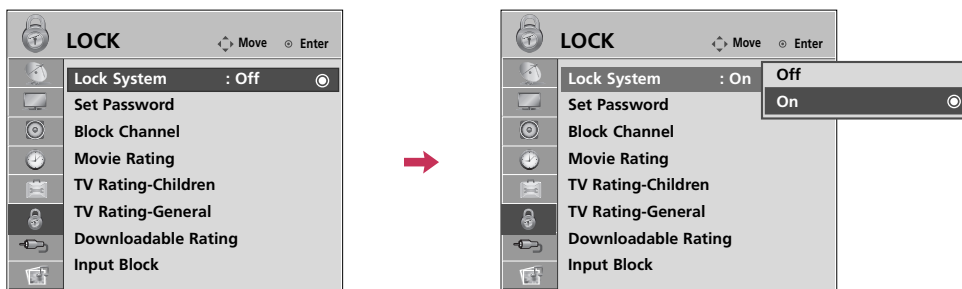



1    Select **LOCK**.

2  Input the password.

3  Select **Lock System**.

4   Select **On** or **Off**.

5  Return to the previous menu.

 Return to TV viewing.



- When you select **On**, the Lock System is enable.

# PARENTAL CONTROL /RATINGS

## Set Password

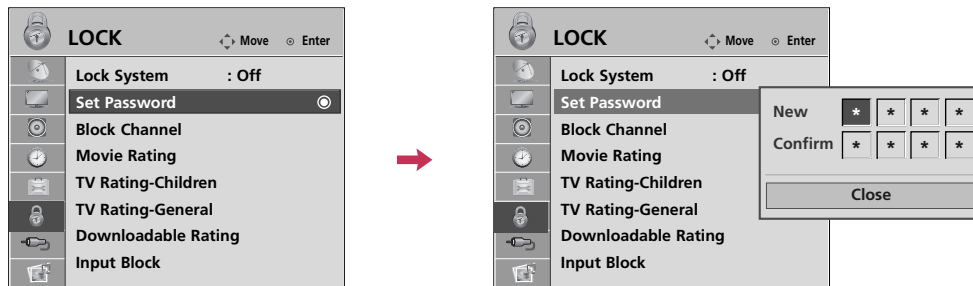
Change the password by inputting a new password twice.

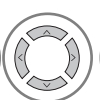



1    Select **LOCK**.

2  Input the password.

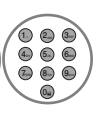
3  Select **Set password**.

4   Choose any 4 digits for your new password.  
As soon as the 4 digits are entered, re-enter the same 4 digits on the **Confirm**.









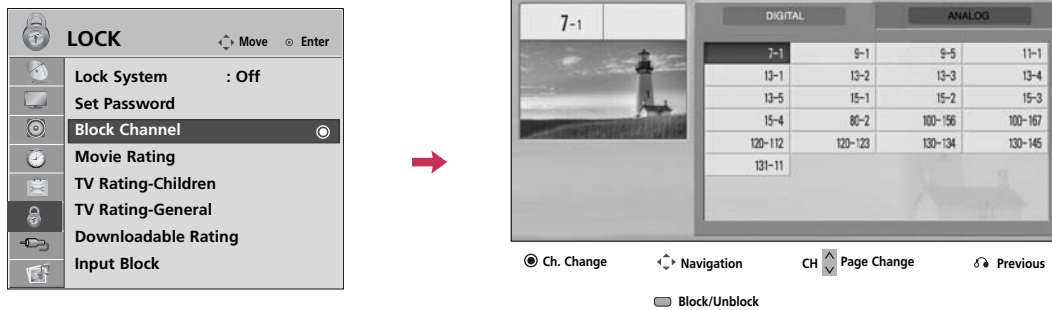

5  Return to the previous menu.

 Return to TV viewing.

# CHANNEL BLOCKING

Blocks any channels that you do not want to watch or that you do not want your children to watch.



- 1    Select **LOCK**.
- 2  Input the password.
- 3  Select **Block Channel**.
- 4   Select a channel to block or unblock.
- 5  Block or unblock a channel.
- 6  Return to the previous menu.
-  Return to TV viewing.



# PARENTAL CONTROL / RATINGS

## MOVIE & TV RATING

### Movie Rating (MPAA)

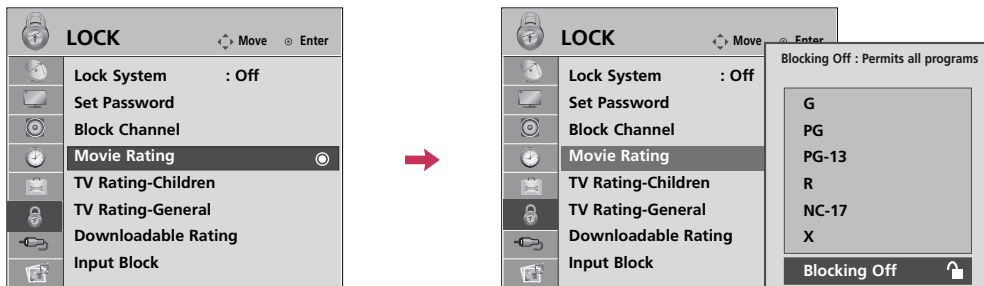
Blocks movies according to the movie ratings limits specified, so children cannot view certain movies. You can set the ratings limit by blocking out all the movies with the ratings above a specified level. Keep in mind that the movie ratings limit only applies to movies shown on TV, not TV programs, such as soap operas.





1    Select **LOCK**.

2  Input the password.

3  Select **Movie Rating**.

4   Select **G, PG, PG-13, R, NC-17, X, or Blocking Off**.

5  Return to the previous menu.



 Return to TV viewing.

- G (General audience)
- PG (Parental guidance suggested)
- PG-13 (Parents strongly cautioned)
- R (Restricted)
- NC-17 (No one 17 and under admitted)
- X (Adult only)
- Blocking Off (Permits all programs)
- ▶ If you set PG-13: G and PG movies will be available, PG-13, R, NC-17 and X will be blocked.

## TV Rating Children

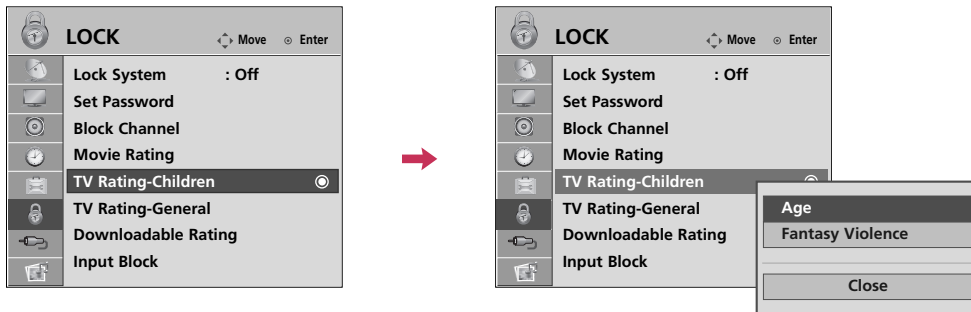
Prevents children from watching certain children's TV programs, according to the ratings limit set. The children rating does not apply to other TV programs. Unless you block certain TV programs intended for mature audiences in the TV Rating - sub menu, your children can view those programs.



1    Select **LOCK**.

2  Input the password.

3  Select **TV Rating-Children**.

4   Select **Age** or **Fantasy Violence**.

5   Select block options.

6  Return to the previous menu.

 Return to TV viewing.

- Age (applies to TV-Y, TV-Y7)
- Fantasy Violence (applies to TV-Y7)

# PARENTAL CONTROL / RATINGS

## TV Rating General

Based on the ratings, blocks certain TV programs that you and your family do not want to view.

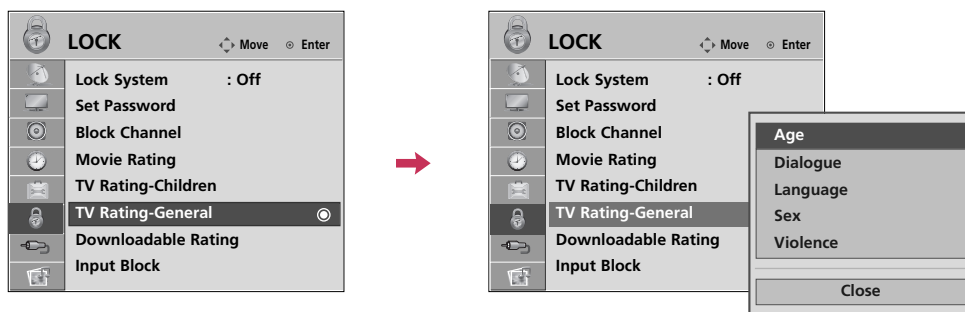

1    Select **LOCK**.

2  Input the password.

3  Select **TV Rating-General**.

4   Select **Age, Dialogue, Language, Sex or Violence**.

5   Select block options.

6  Return to the previous menu.

 Return to TV viewing.

- Age (applies to TV-G,TV-PG,TV-14,TV-MA).
- Dialogue-sexual dialogue (applies to TV-PG,TV-14).
- Language-adult language (applies to TV-PG, TV-14, TV-MA).
- Sex-sexual situations (applies to TV-PG, TV-14, TV-MA).
- Violence (applies to TV-PG, TV-14, TV-MA).







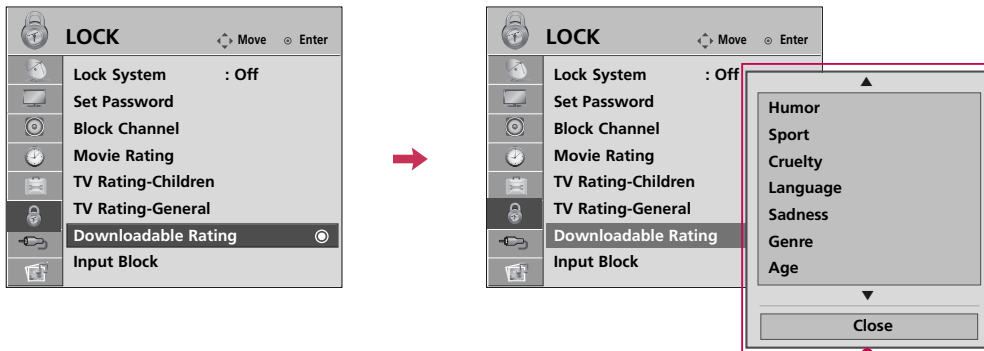





# DOWNLOADABLE RATING

This function operates only when TV has received Region5 Rating data.



■ Based on rating table, your TV's OSD (On Screen Display) may differ slightly from what is shown in this manual.

- 1    Select **LOCK**.
- 2  Input the password.
- 3  Select **Downloadable Rating**.
- 4   Select desired **Downloadable Rating** option.
- 5   Select desired option and block it.
- 6  Return to the previous menu.
-  Return to TV viewing.

■ If a Downloadable rating is locked, enter the password to unlock it temporarily.

# PARENTAL CONTROL /RATINGS

## EXTERNAL INPUT BLOCKING

Enables you to block an input.

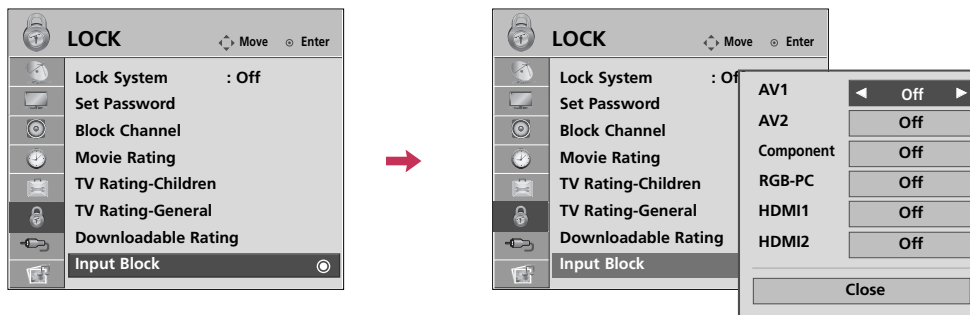

1    Select **LOCK**.

2  Input the password.

3  Select **Input Block**.

4   Select input source.

5  Select **On** or **Off**.

6  Return to the previous menu.

 Return to TV viewing.

# APPENDIX

## TROUBLESHOOTING

### The operation does not work normally.

The remote control doesn't work

- Check to see if there is any object between the product and the remote control causing obstruction. Ensure you are pointing the remote control directly at the TV.
- Ensure that the batteries are installed with correct polarity (+ to +, - to -).
- Ensure that the correct remote operating mode is set: TV, VCR etc.
- Install new batteries.

\*This feature is not available for all models.

Power is suddenly turned off

- Is the sleep timer set?
- Check the power control settings. Power interrupted.
- TV will be automatically turned off, in case of no signal for 15 minutes.

### The video does not work.

No picture & No sound

- Check whether the product is turned on.
- Try another channel. The problem may be with the broadcast.
- Is the power cord inserted into wall power outlet?
- Check your antenna direction and/or location.
- Test the wall power outlet, plug another product's power cord into the outlet where the product's power cord was plugged in.

Picture appears slowly after switching on

- This is normal, the image is muted during the product startup process. Please contact your service center, if the picture has not appeared after five minutes.

No or poor color or poor picture

- Adjust Color in menu option.
- Keep a sufficient distance between the product and the VCR.
- Try another channel. The problem may be with the broadcast.
- Are the video cables installed properly?
- Activate any function to restore the brightness of the picture.

Horizontal/vertical bars or picture shaking

- Check for local interference such as an electrical appliance or power tool.

Poor reception on some channels

- Station or cable product experiencing problems, tune to another station.
- Station signal is weak, reorient antenna to receive weaker station.
- Check for sources of possible interference.

Lines or streaks in pictures

- Check antenna (Change the direction of the antenna).

No picture when connecting HDMI

- Check HDMI cable over version 1.3.  
The HDMI cables don't support HDMI version 1.3, it cause flickers or no screen display. In this case use the latest cables that support HDMI version 1.3.

## The audio does not work.

Picture OK & No sound	<ul style="list-style-type: none"> <li>■ Press the VOL or VOLUME button.</li> <li>■ Sound muted? Press MUTE button.</li> <li>■ Try another channel. The problem may be with the broadcast.</li> <li>■ Are the audio cables installed properly?</li> </ul>
No output from one of the speakers	<ul style="list-style-type: none"> <li>■ Adjust Balance in menu option.</li> </ul>
Unusual sound from inside the product	<ul style="list-style-type: none"> <li>■ A change in ambient humidity or temperature may result in an unusual noise when the product is turned on or off and does not indicate a fault with the product.</li> </ul>
No sound when connecting HDMI or USB	<ul style="list-style-type: none"> <li>■ Check HDMI cable over version 1.3.</li> <li>■ Check USB cable over version 2.0.</li> <li>■ Use normal MP3 file.</li> </ul> <p style="text-align: right;">*This feature is not available for all models.</p>

## There is a problem in PC mode. (Only PC mode applied)

The signal is out of range	<ul style="list-style-type: none"> <li>■ Adjust resolution, horizontal frequency, or vertical frequency.</li> <li>■ Check the input source.</li> </ul>
Vertical bar or stripe on background & Horizontal Noise & Incorrect position	<ul style="list-style-type: none"> <li>■ Work the Auto configure or adjust clock, phase, or H/V position. (Option)</li> </ul>
Screen color is unstable or single color	<ul style="list-style-type: none"> <li>■ Check the signal cable.</li> <li>■ Reinstall the PC video card.</li> </ul>

## Power

No Power	<ul style="list-style-type: none"> <li>■ See troubleshooting flow chart.</li> </ul>
----------	---

## Erratic Operation

Installer menu setup	<ul style="list-style-type: none"> <li>■ Adjust Installer menu settings as required.</li> </ul>
----------------------	---

## Software Problems

Cannot direct enter channel number or "No Signal" appears	<ul style="list-style-type: none"> <li>■ After 2-5-5 + MENU, only channels included in TV controller will appear. If channel is available it can be added to channel scan, rescan channels. If it is not available, the 'No Signal' message appears on the TV screen.</li> </ul>
---	--

### ! NOTE

- ▶ For other problems not caused by the TV, refer to other devices' operating guides.

# MAINTENANCE

Early malfunctions can be prevented. Careful and regular cleaning can extend the amount of time you can enjoy your new TV.

Caution: Be sure to turn the power off and unplug the power cord before you begin any cleaning.

## Cleaning the Screen

- 1 Here's a great way to keep the dust off your screen for a while. Wet a soft cloth in a mixture of lukewarm water and a little fabric softener or dish washing detergent. Wring the cloth until it's almost dry, and then use it to wipe the screen.
- 2 Make sure the excess water is off the screen, and then let it air-dry before you turn on your TV.

### ⚠ WARNING

- ▶ Do not use window/glass cleaner or anything with ammonia to clean the screen.

## Cleaning the Cabinet

- To remove dirt or dust, wipe the cabinet with a soft, dry, lint-free cloth.
- Please be sure not to use a wet cloth.

## Extended Absence

### ⚠ CAUTION

- ▶ If you expect to leave your TV dormant for a long time (such as a vacation), it's a good idea to unplug the power cord to protect against possible damage from lightning or power surges.

# PRODUCT SPECIFICATIONS

MODEL		32LH240H (32LH240H-UA) 32LH250H (32LH250H-UA) 32LH255H (32LH255H-UA)	37LH250H (37LH250H-UA) 37LH255H (37LH255H-UA) 37LH260H (37LH260H-UA) 37LH265H (37LH265H-UA)	42LH250H (42LH250H-UA) 42LH255H (42LH255H-UA) 42LH260H (42LH260H-UA)
Dimensions (Width x Height x Depth)	With stand	31.6 x 22.9 x 8.8 inches 805.0 x 583.0 x 223.8 mm	36.2 x 25.9 x 11.6 inches 922.0 x 659.0 x 297.0 mm	40.4 x 28.1 x 11.6 inches 1028.0 x 715.4 x 297.0 mm
	Without stand	31.6 x 20.7 x 4.2 inches 805.0 x 528.2 x 108.9 mm	36.2 x 23.4 x 3.4 inches 922.0 x 595.0 x 88.0 mm	40.4 x 25.7 x 3.4 inches 1028.0 x 655.0 x 88.7 mm
Weight	With stand	27.7 pounds / 12.6 kg	33.0 pounds / 15.0 kg	41.0 pounds / 18.6 kg
	Without stand	25.1 pounds / 11.4 kg	29.1 pounds / 13.2 kg	37.0 pounds / 16.8 kg
Power requirement	AC100-240V ~ 50/60Hz			
Television System	NTSC-M, ATSC, 64 & 256 QAM			
Program Coverage	VHF 2-13, UHF 14-69, CATV 1-135, DTV 2-69, CADTV 1-135			
External Antenna Impedance	75 ohm			
Environment condition	Operating Temperature	32 ~ 104°F (0 ~ 40°C)		
	Operating Humidity	Less than 80%		
	Storage Temperature	-4 ~ 140°F (-20 ~ 60°C)		
	Storage Humidity	Less than 85%		

- The specifications shown above may be changed without prior notice for quality improvement.

## IR CODES

### 1. How to Connect

- Connect your wired remote control to the Remote Control port on the TV.

### 2. Remote Control IR Codes

#### ■ Output waveform

Single pulse, modulated with 37.917KHz signal at 455KHz

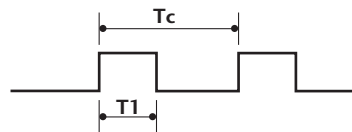

Carrier frequency  
 $FCAR = 1/T_C = f_{OSC}/12$   
 Duty ratio =  $T_1/T_C = 1/3$

#### ■ Configuration of frame

1st frame

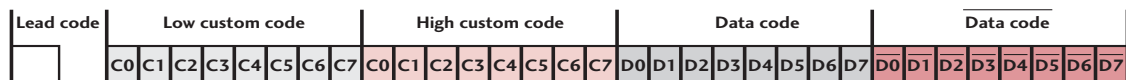

Repeat frame

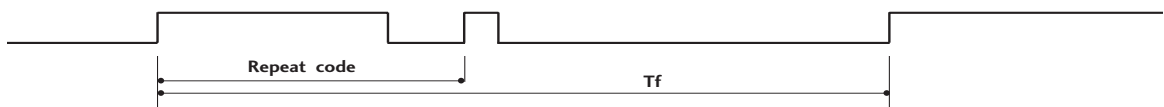

#### ■ Lead code

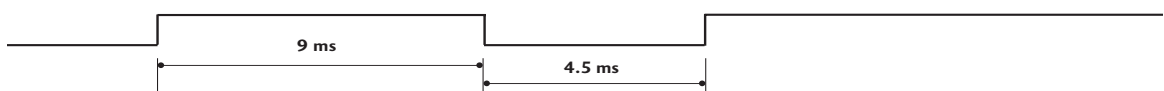

#### ■ Repeat code

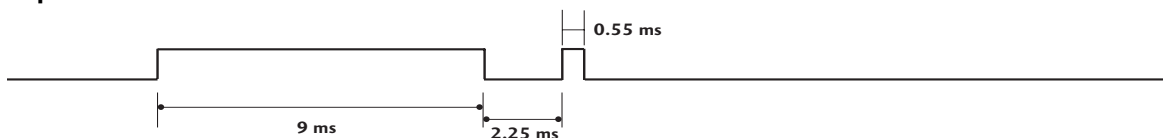

#### ■ Bit description

Bit "0"

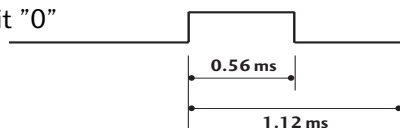

Bit "1"

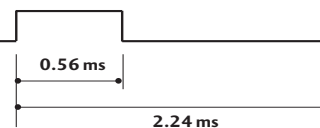

#### ■ Frame interval: $T_f$

The waveform is transmitted as long as a key is depressed.

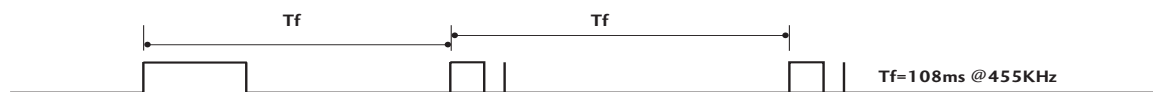

Code (Hexa)	Function	Note	Code (Hexa)	Function	Note
08	POWER	Remote control Button (Power On/Off)	D6	TV	Discrete IR Code (TV Input Selection)
0B	INPUT	Remote control Button	5A	AV1	Discrete IR Code (AV1 Input Selection)
1E	MARK	Remote control Button	D0	AV2	Discrete IR Code (AV2 Input Selection)
79	RATIO	Remote control Button	BF	COMPONENT	Discrete IR Code (COMPONENT Input Selection)
39	CC	Remote control Button	D5	RGB-PC	Discrete IR Code (RGB Input Selection)
10-19	Number Key 0-9	Remote control Button	CE	HDMI1	Discrete IR Code (HDMI1 Input Selection)
4C	- (Dash)/LIST	Remote control Button	CC	HDMI2	Discrete IR Code (HDMI2 Input Selection)
1A	FLASHBK	Remote control Button	76	Ratio 4:3	Discrete IR Code (Only 4:3 Mode)
02	VOL +	Remote control Button	77	Ratio 16:9	Discrete IR Code (Only 16:9 Mode)
03	VOL -	Remote control Button	AF	Ratio Zoom	Discrete IR Code (Only Zoom1 Mode)
00	CH ^	Remote control Button	C4	POWER ON	Discrete IR Code (Only Power On)
01	CH v	Remote control Button	C5	POWER OFF	Discrete IR Code (Only Power Off)
0A	SAP	Remote control Button			
0E	TIMER	Remote control Button			
09	MUTE	Remote control Button			
43	MENU	Remote control Button			
5B	RETURN	Remote control Button			
E8	ALAM	Remote control Button			
CA	EJECT	Remote control Button			
40	^	Remote control Button			
41	v	Remote control Button			
07	<	Remote control Button			
06	>	Remote control Button			
44	ENTER	Remote control Button			
72	RED	Remote control Button			
71	■ (GREEN)	Remote control Button			
63	► (YELLOW)	Remote control Button			
61	(BLUE)	Remote control Button			
8F	◀◀	Remote control Button			
8E	▶▶	Remote control Button			

# OPEN SOURCE LICENSE

## GNU GENERAL PUBLIC LICENSE

Version 2, June 1991

Copyright (C) 1989, 1991 Free Software Foundation, Inc., 51 Franklin Street, Fifth Floor, Boston, MA 02110-1301 USA

Everyone is permitted to copy and distribute verbatim copies of this license document, but changing it is not allowed.

### Preamble

The licenses for most software are designed to take away your freedom to share and change it. By contrast, the GNU General Public License is intended to guarantee your freedom to share and change free software - to make sure the software is free for all its users. This General Public License applies to most of the Free Software Foundation's software and to any other program whose authors commit to using it. (Some other free software foundation software is covered by the GNU Lesser General Public License instead.) You can apply it to your programs, too.

When we speak of free software, we are referring to freedom, not price. Our General Public Licenses are designed to make sure that you have the freedom to distribute copies of free software (and charge for this service if you wish), that you receive source code or can get it if you want it, that you can change the software or use pieces of it in new free programs; and that you know you can do these things.

To protect your rights, we need to make restrictions that forbid anyone to deny you these rights or to ask you to surrender the rights. These restrictions translate to certain responsibilities for you if you distribute copies of the software, or if you modify it.

For example, if you distribute copies of such a program, whether gratis or for a fee, you must give the recipients all the rights that you have. You must make sure that they, too, receive or can get the source code. And you must show them these terms so they know their rights.

We protect your rights with two steps: (1) copyright the software, and (2) offer you this license which gives you legal permission to copy, distribute and/or modify the software.

Also, for each author's protection and ours, we want to make certain that everyone understands that there is no warranty for this free software. If the software is modified by someone else and passed on, we want its recipients to know that what they have is not the original, so that any problems introduced by others will not reflect on the original authors' reputations.

Finally, any free program is threatened constantly by software patents. We wish to avoid the danger that redistributors of a free program will individually obtain patent licenses, in effect making

the program proprietary. To prevent this, we have made it clear that any patent must be licensed for everyone's free use or not licensed at all.

The precise terms and conditions for copying, distribution and modification follow.

### GNU GENERAL PUBLIC LICENSE

#### TERMS AND CONDITIONS FOR COPYING, DISTRIBUTION AND MODIFICATION

0. This license applies to any program or other work which contains a notice placed by the copyright holder saying it may be distributed under the terms of this General Public License. The "Program", below, refers to any such program or work, and a "work based on the Program" means either the Program or any derivative work under copyright law: that is to say, a work containing the Program or a portion of it, either verbatim or with modifications and/or translated into another language. (Hereinafter, translation is included without limitation in the term "modification".) Each licensee is addressed as "you".

Activities other than copying, distribution and modification are not covered by this license; they are outside its scope. The act of running the Program is not restricted, and the output from the program is covered only if its contents constitute a work based on the program (independent of having been made by running the program). Whether that is true depends on what the program does.

1. You may copy and distribute verbatim copies of the program's source code as you receive it, in any medium, provided that you conspicuously and appropriately publish on each copy an appropriate copyright notice and disclaimer of warranty; keep intact all the notices that refer to this license and to the absence of any warranty; and give any other recipients of the program a copy of this license along with the Program.

You may charge a fee for the physical act of transferring a copy, and you may at your option offer warranty protection in exchange for a fee.

2. You may modify your copy or copies of the program or any portion of it, thus forming a work based on the Program, and copy and distribute such modifications or work under the terms of section 1 above, provided that you also meet all of these conditions:

a) You must cause the modified files to carry prominent notices stating that you changed the files and the date of any change.



- b) You must cause any work that you distribute or publish, that in whole or in part contains or is derived from the Program or any part thereof, to be licensed as a whole at no charge to all third parties under the terms of this license.
- c) If the modified program normally reads commands interactively when run, you must cause it, when started running for such interactive use in the most ordinary way, to print or display an announcement including an appropriate copyright notice and a notice that there is no warranty (or else, saying that you provide a warranty) and that users may redistribute the program under these conditions, and telling the user how to view a copy of this license. (Exception: if the Program itself is interactive but does not normally print such an announcement, your work based on the Program is not required to print an announcement.)

These requirements apply to the modified work as a whole. If identifiable sections of that work are not derived from the Program, and can be reasonably considered independent and separate works in themselves, then this license, and its terms, do not apply to those sections when you distribute them as separate works. But when you distribute the same sections as part of a whole which is a work based on the Program, the distribution of the whole must be on the terms of this license, whose permissions for other licensees extend to the entire whole, and thus to each and every part regardless of who wrote it.

Thus, it is not the intent of this section to claim rights or contest your rights to work written entirely by you; rather, the intent is to exercise the right to control the distribution of derivative or collective works based on the program.

In addition, mere aggregation of another work not based on the program with the Program (or with a work based on the program) on a volume of a storage or distribution medium does not bring the other work under the scope of this license.

- 3. You may copy and distribute the program (or a work based on it, under section 2) in object code or executable form under the terms of sections 1 and 2 above provided that you also do one of the following:
  - a) Accompany it with the complete corresponding machine-readable source code, which must be distributed under the terms of sections 1 and 2 above on a medium customarily used for software interchange; or,
  - b) Accompany it with a written offer, valid for at least three years, to give any third party, for a charge no more than your cost of physically performing source distribution, a complete machine-readable copy of the corresponding source code, to be distributed under the terms of sections 1 and 2 above on a medium customarily used for software interchange; or,

- c) Accompany it with the information you received as to the offer to distribute corresponding source code. (This alternative is allowed only for noncommercial distribution and only if you received the program in object code or executable form with such an offer, in accord with Subsection b above.)

The source code for a work means the preferred form of the work for making modifications to it. For an executable work, complete source code means all the source code for all modules it contains, plus any associated interface definition files, plus the scripts used to control compilation and installation of the executable. However, as a special exception, the source code distributed need not include anything that is normally distributed (in either source or binary form) with the major components (compiler, kernel, and so on) of the operating system on which the executable runs, unless that component itself accompanies the executable.

If distribution of executable or object code is made by offering access to copy from a designated place, then offering equivalent access to copy the source code from the same place counts as distribution of the source code, even though third parties are not compelled to copy the source along with the object code.

- 4. You may not copy, modify, sublicense, or distribute the Program except as expressly provided under this license. Any attempt otherwise to copy, modify, sublicense or distribute the Program is void, and will automatically terminate your rights under this license. However, parties who have received copies, or rights, from you under this license will not have their licenses terminated so long as such parties remain in full compliance.
- 5. You are not required to accept this license, since you have not signed it. However, nothing else grants you permission to modify or distribute the Program or its derivative works. These actions are prohibited by law if you do not accept this license. Therefore, by modifying or distributing the program (or any work based on the program), you indicate your acceptance of this license to do so, and all its terms and conditions for copying, distributing or modifying the program or works based on it.
- 6. Each time you redistribute the program (or any work based on the Program), the recipient automatically receives a license from the original licensor to copy, distribute or modify the Program subject to these terms and conditions. You may not impose any further restrictions on the recipients' exercise of the rights granted herein. You are not responsible for enforcing compliance by third parties to this license.

7. If, as a consequence of a court judgment or allegation of patent infringement or for any other reason (not limited to patent issues), conditions are imposed on you (whether by court order, agreement or otherwise) that contradict the conditions of this license, they do not excuse you from the conditions of this license. If you cannot distribute so as to satisfy simultaneously your obligations under this license and any other pertinent obligations, then as a consequence you may not distribute the program at all. For example, if a patent license would not permit royalty-free redistribution of the program by all those who receive copies directly or indirectly through you, then the only way you could satisfy both it and this license would be to refrain entirely from distribution of the program.

If any portion of this section is held invalid or unenforceable under any particular circumstance, the balance of the section is intended to apply and the section as a whole is intended to apply in other circumstances.

It is not the purpose of this section to induce you to infringe any patents or other property right claims or to contest validity of any such claims; this section has the sole purpose of protecting the integrity of the free software distribution system, which is implemented by public license practices. Many people have made generous contributions to the wide range of software distributed through that system in reliance on consistent application of that system; it is up to the author/donor to decide if he or she is willing to distribute software through any other system and a licensee cannot impose that choice.

This section is intended to make thoroughly clear what is believed to be a consequence of the rest of this license.

8. If the distribution and/or use of the program is restricted in certain countries either by patents or by copyrighted interfaces, the original copyright holder who places the program under this license may add an explicit geographical distribution limitation excluding those countries, so that distribution is permitted only in or among countries not thus excluded. In such case, this license incorporates the limitation as if written in the body of this license.
9. The Free Software Foundation may publish revised and/or new versions of the General Public License from time to time. Such new versions will be similar in spirit to the present version, but may differ in detail to address new problems or concerns.

Each version is given a distinguishing version number. If the program specifies a version number of this license which applies to it and "any later version", you have the option of following the terms and conditions either of that version or of

any later version published by the Free Software Foundation. If the program does not specify a version number of this license, you may choose any version ever published by the Free Software Foundation.

10. If you wish to incorporate parts of the program into other programs whose distribution conditions are different, write to the author to ask for permission. For software which is copyrighted by the Free Software Foundation, write to the Free Software Foundation; we sometimes make exceptions for this. Our decision will be guided by the two goals of preserving the free status of all derivatives of our free software and of promoting the sharing and reuse of software generally.

## NO WARRANTY

11. BECAUSE THE PROGRAM IS LICENSED FREE OF CHARGE, THERE IS NO WARRANTY FOR THE PROGRAM, TO THE EXTENT PERMITTED BY APPLICABLE LAW. EXCEPT WHEN OTHERWISE STATED IN WRITING THE COPYRIGHT HOLDERS AND/OR OTHER PARTIES PROVIDE THE PROGRAM "AS IS" WITHOUT WARRANTY OF ANY KIND, EITHER EXPRESSED OR IMPLIED, INCLUDING, BUT NOT LIMITED TO, THE IMPLIED WARRANTIES OF MERCHANTABILITY AND FITNESS FOR A PARTICULAR PURPOSE. THE ENTIRE RISK AS TO THE QUALITY AND PERFORMANCE OF THE PROGRAM IS WITH YOU. SHOULD THE PROGRAM PROVE DEFECTIVE, YOU ASSUME THE COST OF ALL NECESSARY SERVICING, REPAIR OR CORRECTION.
12. IN NO EVENT UNLESS REQUIRED BY APPLICABLE LAW OR AGREED TO IN WRITING WILL ANY COPYRIGHT HOLDER, OR ANY OTHER PARTY WHO MAY MODIFY AND/OR REDISTRIBUTE THE PROGRAM AS PERMITTED ABOVE, BE LIABLE TO YOU FOR DAMAGES, INCLUDING ANY GENERAL, SPECIAL, INCIDENTAL OR CONSEQUENTIAL DAMAGES ARISING OUT OF THE USE OR INABILITY TO USE THE PROGRAM (INCLUDING BUT NOT LIMITED TO LOSS OF DATA OR DATA BEING RENDERED INACCURATE OR LOSSES SUSTAINED BY YOU OR THIRD PARTIES OR A FAILURE OF THE PROGRAM TO OPERATE WITH ANY OTHER PROGRAMS), EVEN IF SUCH HOLDER OR OTHER PARTY HAS BEEN ADVISED OF THE POSSIBILITY OF SUCH DAMAGES.

## END OF TERMS AND CONDITIONS

How to apply these terms to your new programs

If you develop a new program, and you want it to be of the greatest possible use to the public, the best way to achieve this is to make it free software which everyone can redistribute and change under these terms.

To do so, attach the following notices to the program. It is safest to attach them to the start of each source file to most effectively convey the exclusion of warranty; and each file should have at least the "copyright" line and a pointer to where the full notice is found.

one line to give the program's name and a brief idea of what it does.

Copyright (C) <year> <name of author>

This program is free software; you can redistribute it and/or modify it under the terms of the GNU General Public License as published by the Free Software Foundation; either version 2 of the license, or (at your option) any later version.

This program is distributed in the hope that it will be useful, but WITHOUT ANY WARRANTY; without even the implied warranty of MERCHANTABILITY or FITNESS FOR A PARTICULAR PURPOSE. See the GNU General Public License for more details.

You should have received a copy of the GNU General Public License along with this program; if not, write to the Free Software Foundation, Inc., 51 Franklin Street, Fifth Floor, Boston, MA 02110-1301 USA.

Also add information on how to contact you by electronic and paper mail.

If the program is interactive, make it output a short notice like this when it starts in an interactive mode:

Gnomovision version 69, Copyright (C) year name of author  
Gnomovision comes with ABSOLUTELY NO WARRANTY; for details type 'show w'. This is free software, and you are welcome to redistribute it under certain conditions; type 'show c' for details.

The hypothetical commands 'show w' and 'show c' should show the appropriate parts of the General Public License. Of course, the commands you use may be called something other than 'show w' and 'show c'; they could even be mouse-clicks or menu items-whatever suits your program.

You should also get your employer (if you work as a programmer) or your school, if any, to sign a "copyright disclaimer" for the program, if necessary. Here is a sample; alter the names:

Yoyodyne, Inc., hereby disclaims all copyright interest in the program 'Gnomovision' (which makes passes at compilers) written by James Hacker.

signature of Ty Coon, 1 April 1989  
Ty Coon, President of Vice

This General Public License does not permit incorporating your program into proprietary programs. If your program is a subroutine library, you may consider it more useful to permit linking proprietary applications with the library. If this is what you want to do, use the GNU Lesser General Public License instead of this license.

# GNU LESSER GENERAL PUBLIC LICENSE

Version 2.1, February 1999

Copyright (C) 1991, 1999 Free Software Foundation, Inc. 51 Franklin Street, Fifth Floor, Boston, MA 02110-1301 USA  
Everyone is permitted to copy and distribute verbatim copies of this license document, but changing it is not allowed.

[This is the first released version of the Lesser GPL. It also counts as the successor of the GNU Library Public License, version 2, hence the version number 2.1.]

## Preamble

The licenses for most software are designed to take away your freedom to share and change it. By contrast, the GNU General Public Licenses are intended to guarantee your freedom to share and change free software - to make sure the software is free for all its users.

This license, the Lesser General Public License, applies to some specially designated software packages - typically libraries - of the Free Software Foundation and other authors who decide to use it. You can use it too, but we suggest you first think carefully about whether this license or the ordinary General Public License is the better strategy to use in any particular case, based on the explanations below.

When we speak of free software, we are referring to freedom of use, not price. Our General Public Licenses are designed to make sure that you have the freedom to distribute copies of free software (and charge for this service if you wish); that you receive source code or can get it if you want it; that you can change the software and use pieces of it in new free programs; and that you are informed that you can do these things.

To protect your rights, we need to make restrictions that forbid distributors to deny you these rights or to ask you to surrender these rights. These restrictions translate to certain responsibilities for you if you distribute copies of the library or if you modify it.

For example, if you distribute copies of the library, whether gratis or for a fee, you must give the recipients all the rights that we gave you. You must make sure that they, too, receive or can get the source code. If you link other code with the library, you must provide complete object files to the recipients, so that they can relink them with the library after making changes to the library and recompiling it. And you must show them these terms so they know their rights.

We protect your rights with a two-step method: (1) we copyright the library, and (2) we offer you this license, which gives you legal permission to copy, distribute and/or modify the library.

To protect each distributor, we want to make it very clear that there is no warranty for the free library. Also, if the library is modified by someone else and passed on, the recipients should know that what they have is not the original version, so that the original author's reputation will not be affected by problems that might be introduced by others.

Finally, software patents pose a constant threat to the existence of any free program. We wish to make sure that a company cannot effectively restrict the users of a free program by obtaining a restrictive license from a patent holder. Therefore, we insist that any patent license obtained for a version of the library must be consistent with the full freedom of use specified in this license.

Most GNU software, including some libraries, is covered by the ordinary GNU General Public License. This license, the GNU Lesser General Public License, applies to certain designated libraries, and is quite different from the ordinary General Public License. We use this license for certain libraries in order to permit linking those libraries into non-free programs.

When a program is linked with a library, whether statically or using a shared library, the combination of the two is legally speaking a combined work, a derivative of the original library. The ordinary General Public License therefore permits such linking only if the entire combination fits its criteria of freedom. The Lesser General Public License permits more lax criteria for linking other code with the library.

We call this license the "Lesser" General Public License because it does Less to protect the user's freedom than the ordinary General Public License. It also provides other free software developers Less of an advantage over competing non-free programs. These disadvantages are the reason we use the ordinary General Public License for many libraries. However, the Lesser license provides advantages in certain special circumstances.

For example, on rare occasions, there may be a special need to encourage the widest possible use of a certain library, so that it becomes a de-facto standard. To achieve this, non-free programs must be allowed to use the library. A more frequent case is that a free library does the same job as widely used non-free libraries. In this case, there is little to gain by limiting the free library to free software only, so we use the Lesser General Public License.

In other cases, permission to use a particular library in non-free programs enables a greater number of people to use a large body of free software. For example, permission to use the GNU C Library in non-free programs enables many more people to use the whole GNU operating system, as well as its variant, the GNU/Linux operating system.

Although the Lesser General Public License is Less protective of the users' freedom, it does ensure that the user of a program that is linked with the Library has the freedom and the wherewithal to run that program using a modified version of the Library.

The precise terms and conditions for copying, distribution and modification follow. Pay close attention to the difference between a "work based on the library" and a "work that uses the library". The former contains code derived from the library, whereas the latter must be combined with the library in order to run.

#### GNU LESSER GENERAL PUBLIC LICENSE TERMS AND CONDITIONS FOR COPYING, DISTRIBUTION AND MODIFICATION

0. This license agreement applies to any software library or other program which contains a notice placed by the copyright holder or other authorized party saying it may be distributed under the terms of this Lesser General Public License (also called "this license"). Each license is addressed as "you".

A "library" means a collection of software functions and/or data prepared so as to be conveniently linked with application programs (which use some of those functions and data) to form executables.

The "Library", below, refers to any such software library or work which has been distributed under these terms. A "work based on the Library" means either the Library or any derivative work under copyright law: that is to say, a work containing the library or a portion of it, either verbatim or with modifications and/or translated straightforwardly into another language. (Hereinafter, translation is included without limitation in the term "modification".)

"Source code" for a work means the preferred form of the work for making modifications to it. For a library, complete source code means all the source code for all modules it contains, plus any associated interface definition files, plus the scripts used to control compilation and installation of the library.

Activities other than copying, distribution and modification are not covered by this license; they are outside its scope. The act of running a program using the Library is not restricted, and output from such a program is covered only if its contents constitute a work based on the library (independent of the use of the Library in a tool for writing it). Whether that is true depends on what the library does and what the program that uses the library does.

1. You may copy and distribute verbatim copies of the library's complete source code as you receive it, in any medium, provided that you conspicuously and appropriately publish on

each copy an appropriate copyright notice and disclaimer of warranty; keep intact all the notices that refer to this license and to the absence of any warranty; and distribute a copy of this license along with the Library.

You may charge a fee for the physical act of transferring a copy, and you may at your option offer warranty protection in exchange for a fee.

2. You may modify your copy or copies of the Library or any portion of it, thus forming a work based on the Library, and copy and distribute such modifications or work under the terms of section 1 above, provided that you also meet all of these conditions:

- a) The modified work must itself be a software library.
- b) You must cause the files modified to carry prominent notices stating that you changed the files and the date of any change.
- c) You must cause the whole of the work to be licensed at no charge to all third parties under the terms of this license.
- d) If a facility in the modified Library refers to a function or a table of data to be supplied by an application program that uses the facility, other than as an argument passed when the facility is invoked, then you must make a good faith effort to ensure that, in the event an application does not supply such function or table, the facility still operates, and performs whatever part of its purpose remains meaningful.

(For example, a function in a library to compute square roots has a purpose that is entirely well-defined independent of the application. Therefore, Subsection 2d requires that any application-supplied function or table used by this function must be optional: if the application does not supply it, the square root function must still compute square roots.)

These requirements apply to the modified work as a whole. If identifiable sections of that work are not derived from the library, and can be reasonably considered independent and separate works in themselves, then this license, and its terms, do not apply to those sections when you distribute them as separate works. But when you distribute the same sections as part of a whole which is a work based on the library, the distribution of the whole must be on the terms of this license, whose permissions for other licenses extend to the entire whole, and thus to each and every part regardless of who wrote it.

Thus, it is not the intent of this section to claim rights or contest your rights to work written entirely by you; rather, the intent is to exercise the right to control the distribution of derivative or collective works based on the library.

In addition, mere aggregation of another work not based on the library with the library (or with a work based on the library) on a volume of a storage or distribution medium does not bring the other work under the scope of this license.

3. You may opt to apply the terms of the ordinary GNU General Public License instead of this License to a given copy of the Library. To do this, you must alter all the notices that refer to this License, so that they refer to the ordinary GNU General Public License, version 2, instead of to this License. (If a newer version than version 2 of the ordinary GNU General Public License has appeared, then you can specify that version instead if you wish.) Do not make any other change in these notices.

Once this change is made in a given copy, it is irreversible for that copy, so the ordinary GNU General Public License applies to all subsequent copies and derivative works made from that copy.

This option is useful when you wish to copy part of the code of the library into a program that is not a library.

4. You may copy and distribute the library (or a portion or derivative of it, under Section 2) in object code or executable form under the terms of Sections 1 and 2 above provided that you accompany it with the complete corresponding machine-readable source code, which must be distributed under the terms of sections 1 and 2 above on a medium customarily used for software interchange.

If distribution of object code is made by offering access to copy from a designated place, then offering equivalent access to copy the source code from the same place satisfies the requirement to distribute the source code, even though third parties are not compelled to copy the source along with the object code.

5. A program that contains no derivative of any portion of the Library, but is designed to work with the Library by being compiled or linked with it, is called a "work that uses the Library". Such a work, in isolation, is not a derivative work of the Library, and therefore falls outside the scope of this license.

However, linking a "work that uses the library" with the Library creates an executable that is a derivative of the Library (because it contains portions of the library), rather than a "work that uses the library". The executable is therefore covered by this license. Section 6 states terms for distribution of such executable.

When a "work that uses the library" uses material from a header file that is part of the library, the object code for the work may be a derivative work of the library even though the source code is not.

Whether this is true is especially significant if the work can be linked without the library, or if the work is itself a library. The threshold for this to be true is not precisely defined by law.

If such an object file uses only numerical parameters, data structure layouts and accessories, and small macros and small inline functions (ten lines or less in length), then the use of

the object file is unrestricted, regardless of whether it is legally a derivative work. (Executable containing this object code plus portions of the library will still fall under Section 6.)

Otherwise, if the work is a derivative of the library, you may distribute the object code for the work under the terms of Section 6. Any executable containing that work also fall under Section 6, whether or not they are linked directly with the library itself.

6. As an exception to the sections above, you may also combine or link a "work that uses the library" with the library to produce a work containing portions of the library, and distribute that work under terms of your choice, provided that the terms permit modification of the work for the customer's own use and reverse engineering for debugging such modifications.

You must give prominent notice with each copy of the work that the library is used in it and that the Library and its use are covered by this license. You must supply a copy of this license. If the work during execution displays copyright notices, you must include the copyright notice for the library among them, as well as a reference directing the user to the copy of this license. Also, you must do one of these things:

- a) Accompany the work with the complete corresponding machine-readable source code for the library including whatever changes were used in the work (which must be distributed under Sections 1 and 2 above); and, if the work is an executable linked with the Library, with the complete machine-readable "work that uses the Library", as object code and/or source code, so that the user can modify the library and then relink to produce a modified executable containing the modified library. (It is understood that the user who changes the contents of definitions files in the library will not necessarily be able to recompile the application to use the modified definitions.)
- b) Use a suitable shared library mechanism for linking with the library. A suitable mechanism is one that (1) uses at run time a copy of the library already present on the user's computer system, rather than copying library functions into the executable, and (2) will operate properly with a modified version of the library, if the user installs one, as long as the modified version is interface-compatible with the version that the work was made with.
- c) Accompany the work with a written offer, valid for at least three years, to give the same user the materials specified in Subsection 6, above, for a charge no more than the cost of performing this distribution.
- d) If distribution of the work is made by offering access to copy from a designated place, offer equivalent access to copy the above specified materials from the same place.
- e) Verify that the user has already received a copy of these materials or that you have already sent this user a copy.

For an executable, the required form of the "work that uses the library" must include any data and utility programs needed for reproducing the executable from it. However, as a special exception, the materials to be distributed need not include anything that is normally distributed (in either source or binary form) with the major components (compiler, kernel, and so on) of the operating system on which the executable runs, unless that component itself accompanies the executable.

It may happen that this requirement contradicts the license restrictions of other proprietary libraries that do not normally accompany the operating system. Such a contradiction means you cannot use both them and the library together in an executable that you distribute.

7. You may place library facilities that are a work based on the library side-by-side in a single library together with other library facilities not covered by this license, and distribute such a combined library, provided that the separate distribution of the work based on the Library and of the other library facilities is otherwise permitted, and provided that you do these two things:
  - a) Accompany the combined library with a copy of the same work based on the Library, uncombined with any other library facilities. This must be distributed under the terms of the sections above.
  - b) Give prominent notice with the combined library of the fact that part of it is a work based on the library, and explaining where to find the accompanying uncombined form of the same work.
8. You may not copy, modify, sublicense, link with, or distribute the library except as expressly provided under this license. Any attempt otherwise to copy, modify, sublicense, link with, or distribute the library is void, and will automatically terminate your rights under this license. However, parties who have received copies, or rights, from you under this license will not have their licenses terminated so long as such parties remain in full compliance.
9. You are not required to accept this license, since you have not signed it. However, nothing else grants you permission to modify or distribute the library or its derivative works. These actions are prohibited by law if you do not accept this license. Therefore, by modifying or distributing the library (or any work based on the library), you indicate your acceptance of this license to do so, and all its terms and conditions for copying, distributing or modifying the library or works based on it.
10. Each time you redistribute the library (or any work based on the Library), the recipient automatically receives a license from the original licensor to copy, distribute, link with or modify the library subject to these terms and conditions. You may not impose any further restrictions on the recipients' exercise

of the rights granted herein.

You are not responsible for enforcing compliance by third parties with this license.

11. If, as a consequence of a court judgment or allegation of patent infringement or for any other reason (not limited to patent issues), conditions are imposed on you (whether by court order, agreement or otherwise) that contradict the conditions of this license, they do not excuse you from the conditions of this license. If you cannot distribute so as to satisfy simultaneously your obligations under this license and any other pertinent obligations, then as a consequence you may not distribute the library at all. For example, if a patent license would not permit royalty-free redistribution of the library by all those who receive copies directly or indirectly through you, then the only way you could satisfy both it and this license would be to refrain entirely from distribution of the library.

If any portion of this section is held invalid or unenforceable under any particular circumstance, the balance of the section is intended to apply, and the section as a whole is intended to apply in other circumstances.

It is not the purpose of this section to induce you to infringe any patents or other property right claims or to contest validity of any such claims; this section has the sole purpose of protecting the integrity of the free software distribution system which is implemented by public license practices. Many people have made generous contributions to the wide range of software distributed through that system in reliance on consistent application of that system; it is up to the author/donor to decide if he or she is willing to distribute software through any other system and a license cannot impose that choice.

This section is intended to make thoroughly clear what is believed to be a consequence of the rest of this license.
12. If the distribution and/or use of the library is restricted in certain countries either by patents or by copyrighted interfaces, the original copyright holder who places the library under this license may add an explicit geographical distribution limitation excluding those countries, so that distribution is permitted only in or among countries not thus excluded. In such case, this license incorporates the limitation as if written in the body of this license.
13. The Free Software Foundation may publish revised and/or new versions of the Lesser General Public License from time to time. Such new versions will be similar in spirit to the present version, but may differ in detail to address new problems or concerns.

Each version is given a distinguishing version number. If the library specifies a version number of this license which applies to it and "any later version", you have the option of following the terms and conditions either of that version or of any later version published by the Free Software Foundation.

If the library does not specify a license version number, you may choose any version ever published by the Free Software Foundation.

14. If you wish to incorporate parts of the library into other free programs whose distribution conditions are incompatible with these, write to the author to ask for permission. For software which is copyrighted by the Free Software Foundation, write to the Free Software Foundation; we sometimes make exceptions for this. Our decision will be guided by the two goals of preserving the free status of all derivatives of our free software and of promoting the sharing and reuse of software generally.

#### NO WARRANTY

15. BECAUSE THE LIBRARY IS LICENSED FREE OF CHARGE, THERE IS NO WARRANTY FOR THE LIBRARY, TO THE EXTENT PERMITTED BY APPLICABLE LAW. EXCEPT WHEN OTHERWISE STATED IN WRITING THE COPYRIGHT HOLDERS AND/OR OTHER PARTIES PROVIDE THE LIBRARY "AS IS" WITHOUT WARRANTY OF ANY KIND, EITHER EXPRESSED OR IMPLIED, INCLUDING, BUT NOT LIMITED TO, THE IMPLIED WARRANTIES OF MERCHANTABILITY AND FITNESS FOR A PARTICULAR PURPOSE. THE ENTIRE RISK AS TO THE QUALITY AND PERFORMANCE OF THE LIBRARY IS WITH YOU. SHOULD THE LIBRARY PROVE DEFECTIVE, YOU ASSUME THE COST OF ALL NECESSARY SERVICING, REPAIR OR CORRECTION.

16. IN NO EVENT UNLESS REQUIRED BY APPLICABLE LAW OR AGREED TO IN WRITING WILL ANY COPYRIGHT HOLDER, OR ANY OTHER PARTY WHO MAY MODIFY AND/OR REDISTRIBUTE THE LIBRARY AS PERMITTED ABOVE, BE LIABLE TO YOU FOR DAMAGES, INCLUDING ANY GENERAL, SPECIAL, INCIDENTAL OR CONSEQUENTIAL DAMAGES ARISING OUT OF THE USE OR INABILITY TO USE THE LIBRARY (INCLUDING BUT NOT LIMITED TO LOSS OF DATA OR DATA BEING RENDERED INACCURATE OR LOSSES SUSTAINED BY YOU OR THIRD PARTIES OR A FAILURE OF THE LIBRARY TO OPERATE WITH ANY OTHER SOFTWARE), EVEN IF SUCH HOLDER OR OTHER PARTY HAS BEEN ADVISED OF THE POSSIBILITY OF SUCH DAMAGES.

#### END OF TERMS AND CONDITIONS

##### How to apply these terms to your new libraries

If you develop a new library, and you want it to be of the greatest possible use to the public, we recommend making it free software that everyone can redistribute and change. You can do so by permitting redistribution under these terms (or, alternatively, under the terms of the ordinary General Public License).

To apply these terms, attach the following notices to the library. It is safest to attach them to the start of each source file to most effectively convey the exclusion of warranty; and each file should have at least the "copyright" line and a pointer to where the full notice is found.

one line to give the library's name and a brief idea of what it does.  
Copyright (C) <year> <name of author>

This library is free software; you can redistribute it and/or modify it under the terms of the GNU Lesser General Public License as published by the Free Software Foundation; either version 2.1 of the license, or (at your option) any later version.

This library is distributed in the hope that it will be useful, but WITHOUT ANY WARRANTY; without even the implied warranty of MERCHANTABILITY or FITNESS FOR A PARTICULAR PURPOSE. See the GNU Lesser General Public License for more details.

You should have received a copy of the GNU Lesser General Public License along with this library; if not, write to the Free Software Foundation, Inc., 51 Franklin Street, Fifth Floor, Boston, MA 02110-1301 USA

Also add information on how to contact you by electronic and paper mail.

You should also get your employer (if you work as a programmer) or your school, if any, to sign a "copyright disclaimer" for the library, if necessary. Here is a sample; alter the names:

Yoyodyne, Inc., hereby disclaims all copyright interest in the library 'Frob' (a library for tweaking knobs) written by James Random Hacker.

signature of Ty Coon, 1 April 1990  
Ty Coon, President of Vice



# MOZILLA PUBLIC LICENSE

Version 1.1

-----

## 1. Definitions.

1.0.1. "Commercial use" means distribution or otherwise making the covered code available to a third party.

1.1. "Contributor" means each entity that creates or contributes to the creation of modifications.

1.2. "Contributor version" means the combination of the original code, prior modifications used by a contributor, and the modifications made by that particular contributor.

1.3. "Covered code" means the original code or modifications or the combination of the original code and modifications, in each case including portions thereof.

1.4. "Electronic distribution mechanism" means a mechanism generally accepted in the software development community for the electronic transfer of data.

1.5. "Executable" means covered code in any form other than source code.

1.6. "Initial developer" means the individual or entity identified as the initial Developer in the Source Code notice required by exhibit A.

1.7. "Larger work" means a work which combines covered code or portions thereof with code not governed by the terms of this License.

1.8. "License" means this document.

1.8.1. "Licensable" means having the right to grant, to the maximum extent possible, whether at the time of the initial grant or subsequently acquired, any and all of the rights conveyed herein.

1.9. "Modifications" means any addition to or deletion from the substance or structure of either the original code or any previous modifications. When covered code is released as a series of files, a modification is:

A. Any addition to or deletion from the contents of a file containing original code or previous modifications.

B. Any new file that contains any part of the original code or previous modifications.

1.10. "Original code" means source code of computer software

code which is described in the source code notice required by exhibit as original code, and which, at the time of its release under this license is not already covered code governed by this license.

1.10.1. "Patent claims" means any patent claim(s), now owned or hereafter acquired, including without limitation, method, process, and apparatus claims, in any patent licensable by grantor.

1.11. "Source code" means the preferred form of the covered code for making modifications to it, including all modules it contains, plus any associated interface definition files, scripts used to control compilation and installation of an executable, or source code differential comparisons against either the original code or another well known, available covered code of the contributor's choice. The source code can be in a compressed or archival form, provided the appropriate decompression or de-archiving software is widely available for no charge.

1.12. "You" (or "Your") means an individual or a legal entity exercising rights under, and complying with all of the terms of, this license or a future version of this license issued under section 6.1.

For legal entities, "You" includes any entity which controls, is controlled by, or is under common control with You. For purposes of this definition, "control" means (a) the power, direct or indirect, to cause the direction or management of such entity, whether by contract or otherwise, or (b) ownership of more than fifty percent (50%) of the outstanding shares or beneficial ownership of such entity.

## 2. Source Code License.

### 2.1. The initial developer grant.

The initial developer hereby grants You a world-wide, royalty-free, non-exclusive license, subject to third party intellectual property claims:

- a) under intellectual property rights (other than patent or trademark) licensable by initial developer to use, reproduce, modify, display, perform, sublicense and distribute the original code (or portions thereof) with or without modifications, and/or as part of a larger work; and
- (b) under patents claims infringed by the making, using or selling of original code, to make, have made, use, practice, sell, and offer for sale, and/or otherwise dispose of the original code (or portions thereof).

- (c) the licenses granted in this section 2.1 (a) and (b) are effective on the date Initial developer first distributes original code under the terms of this license.
- (d) Notwithstanding section 2.1(b) above, no patent license is granted: 1) for code that You delete from the original Code; 2) separate from the original code; or 3) for infringements caused by: i) the modification of the original code or ii) the combination of the original code with other software or devices.

## 2.2. Contributor Grant.

Subject to third party intellectual property claims, each contributor hereby grants You a world-wide, royalty-free, non-exclusive license

- (a) under intellectual property rights (other than patent or trademark) licensable by contributor, to use, reproduce, modify, display, perform, sublicense and distribute the modifications created by such contributor (or portions thereof) either on an unmodified basis, with other modifications, as covered code and/or as part of a larger work; and
- (b) under patent claims infringed by the making, using, or selling of modifications made by that contributor either alone and/or in combination with its contributor version (or portions of such combination), to make, use, sell, offer for sale, have made, and/or otherwise dispose of: 1) modifications made by that contributor (or portions thereof); and 2) the combination of modifications made by that contributor with its contributor version (or portions of such combination).
- (c) the licenses granted in sections 2.2(a) and 2.2(b) are effective on the date contributor first makes commercial use of the covered code.
- (d) Notwithstanding section 2.2(b) above, no patent license is granted: 1) for any code that contributor has deleted from the contributor version; 2) separate from the contributor version; 3) for infringements caused by: i) third party modifications of contributor version or ii) the combination of modifications made by that contributor with other software (except as part of the contributor version) or other devices; or 4) under patent claims infringed by covered code in the absence of modifications made by that contributor.

## 3. Distribution Obligations.

### 3.1. Application of license.

The modifications which You create or to which you contribute are governed by the terms of this license, including without limitation section 2.2. The source code version of covered code may be distributed only under the terms of this license or a future version of this license released under section 6.1, and you must include a copy of this license with every copy of the source code you distribute.

You may not offer or impose any terms on any source code version that alters or restricts the applicable version of this license or the recipients' rights hereunder. However, you may include an additional document offering the additional rights described in section 3.5.

### 3.2. Availability of source code.

Any modification which you create or to which you contribute must be made available in source code form under the terms of this license either on the same media as an executable version or via an accepted electronic distribution mechanism to anyone to whom you made an executable version available; and if made available via electronic distribution mechanism, must remain available for at least twelve (12) months after the date it initially became available, or at least six (6) months after a subsequent version of that particular modification has been made available to such recipients. You are responsible for ensuring that the source code version remains available even if the electronic distribution mechanism is maintained by a third party.

### 3.3. Description of modifications.

You must cause all covered code to which you contribute to contain a file documenting the changes You made to create that covered code and the date of any change. You must include a prominent statement that the modification is derived, directly or indirectly, from original code provided by the initial developer and including the name of the initial developer in (a) the source code, and (b) in any notice in an executable version or related documentation in which you describe the origin or ownership of the covered code.

### 3.4. Intellectual property matters

#### (a) Third party claims.

If contributor has knowledge that a license under a third party's intellectual property rights is required to exercise the rights granted by such contributor under sections 2.1 or 2.2, contributor must include a text file with the source code distribution titled "LEGAL" which describes the claim and the party making the claim in sufficient detail that a recipient will know whom to contact. If contributor obtains such knowledge after the modification is made available as described in section 3.2, contributor shall promptly modify the LEGAL file in all copies contributor makes available thereafter and shall take other steps (such as notifying appropriate mailing lists or newsgroups) reasonably calculated to inform those who received the covered code that new knowledge has been obtained.

#### (b) Contributor APIs.

If contributor's modifications include an application programming interface and contributor has knowledge of patent licenses which are reasonably necessary to implement that API, contributor must also include this information in the LEGAL file.

(c) Representations.

contributor represents that, except as disclosed pursuant to section 3.4(a) above, contributor believes that contributor's modifications are contributor's original creation(s) and/or contributor has sufficient rights to grant the rights conveyed by this license.

3.5. Required notices.

You must duplicate the notice in exhibit A in each file of the source code. If it is not possible to put such notice in a particular source code file due to its structure, then You must include such notice in a location (such as a relevant directory) where a user would be likely to look for such a notice. If You created one or more modification(s), you may add your name as a contributor to the notice described in exhibit A. you must also duplicate this license in any documentation for the source code where You describe recipients' rights or ownership rights relating to covered code. You may choose to offer, and to charge a fee for, warranty, support, indemnity or liability obligations to one or more recipients of covered code. However, you may do so only on your own behalf, and not on behalf of the Initial developer or any contributor. You must make it absolutely clear than any such warranty, support, indemnity or liability obligation is offered by you alone, and You hereby agree to indemnify the Initial developer and every contributor for any liability incurred by the Initial developer or such contributor as a result of warranty, support, indemnity or liability terms you offer.

3.6. Distribution of executable versions.

You may distribute covered code in executable form only if the requirements of section 3.1-3.5 have been met for that covered code, and if you include a notice stating that the source code version of the covered code is available under the terms of this license, including a description of how and where you have fulfilled the obligations of section 3.2. The notice must be conspicuously included in any notice in an executable version, related documentation or collateral in which you describe recipients' rights relating to the covered code. You may distribute the executable version of covered code or ownership rights under a license of your choice, which may contain terms different from this license, provided that you are in compliance with the terms of this license and that the license for the executable version does not attempt to limit or alter the recipient's rights in the source code version from the rights set forth in this license. If you distribute the executable version under a different license you must make it absolutely clear that any terms which differ from this license are offered by you alone, not by the Initial developer or any contributor. You hereby agree to indemnify the initial developer and every contributor for any liability incurred by the initial developer or such contributor as a result of any such terms You offer.

3.7. Larger works.

You may create a larger work by combining covered code with other code not governed by the terms of this license and distribute the larger work as a single product. In such a case, you must make sure the requirements of this license are fulfilled for the covered code.

4. Inability to comply due to statute or regulation.

If it is impossible for you to comply with any of the terms of this license with respect to some or all of the covered code due to statute, judicial order, or regulation then you must: (a) comply with the terms of this license to the maximum extent possible; and (b) describe the limitations and the code they affect. Such description must be included in the LEGAL file described in section 3.4 and must be included with all distributions of the source code. Except to the extent prohibited by statute or regulation, such description must be sufficiently detailed for a recipient of ordinary skill to be able to understand it.

5. Application of this license.

This license applies to code to which the initial developer has attached the notice in exhibit A and to related covered code.

6. Versions of the license.

6.1. New versions.

Netscape communications corporation ("Netscape") may publish revised and/or new versions of the license from time to time. Each version will be given a distinguishing version number.

6.2. Effect of new versions.

Once covered code has been published under a particular version of the license, you may always continue to use it under the terms of that version. You may also choose to use such covered code under the terms of any subsequent version of the license published by netscape. No one other than netscape has the right to modify the terms applicable to covered code created under this license.

6.3. Derivative works.

If You create or use a modified version of this license (which you may only do in order to apply it to code which is not already covered code governed by this license), You must (a) rename Your license so that the phrases "Mozilla", "MOZILLAPL", "MOZPL", "Netscape", "MPL", "NPL" or any confusingly similar phrase do not appear in your license (except to note that your license differs from this license) and (b) otherwise make it clear that Your version of the license contains terms which differ from the Mozilla Public license and netscape Public License. (Filling in the name of the initial developer, original code or contributor in the notice described in exhibit A shall not of themselves be deemed to be modifications of this license.)

## 7. DISCLAIMER OF WARRANTY.

COVERED CODE IS PROVIDED UNDER THIS LICENSE ON AN "AS IS" BASIS, WITHOUT WARRANTY OF ANY KIND, EITHER EXPRESSED OR IMPLIED, INCLUDING, WITHOUT LIMITATION, WARRANTIES THAT THE COVERED CODE IS FREE OF DEFECTS, MERCHANTABILITY, FIT FOR A PARTICULAR PURPOSE OR NON-INFRINGEMENT. THE ENTIRE RISK AS TO THE QUALITY AND PERFORMANCE OF THE COVERED CODE IS WITH YOU. SHOULD ANY COVERED CODE PROVE DEFECTIVE IN ANY RESPECT, YOU (NOT THE INITIAL DEVELOPER OR ANY OTHER CONTRIBUTOR) ASSUME THE COST OF ANY NECESSARY SERVICING, REPAIR OR CORRECTION. THIS DISCLAIMER OF WARRANTY CONSTITUTES AN ESSENTIAL PART OF THIS LICENSE. NO USE OF ANY COVERED CODE IS AUTHORIZED HEREUNDER EXCEPT UNDER THIS DISCLAIMER.

## 8. TERMINATION.

- 8.1. This license and the rights granted hereunder will terminate automatically if you fail to comply with terms herein and fail to cure such breach within 30 days of becoming aware of the breach. All sublicenses to the covered code which are properly granted shall survive any termination of this license. Provisions which, by their nature, must remain in effect beyond the termination of this license shall survive.
- 8.2. If you initiate litigation by asserting a patent infringement claim (excluding declaratory judgment actions) against initial developer or a contributor (the initial developer or contributor against whom you file such action is referred to as "Participant") alleging that:
  - (a) such participant's contributor version directly or indirectly infringes any patent, then any and all rights granted by such participant to you under sections 2.1 and/or 2.2 of this license shall, upon 60 days notice from Participant terminate prospectively, unless if within 60 days after receipt of notice you either: (i) agree in writing to pay participant a mutually agreeable reasonable royalty for your past and future use of modifications made by such participant, or (ii) withdraw your litigation claim with respect to the contributor version against such participant. If within 60 days of notice, a reasonable royalty and payment arrangement are not mutually agreed upon in writing by the parties or the litigation claim is not withdrawn, the rights granted by participant to you under sections 2.1 and/or 2.2 automatically terminate at the expiration of the 60 day notice period specified above.
  - (b) any software, hardware, or device, other than such participant's contributor Version, directly or indirectly infringes any patent, then any rights granted to You by

such participant under sections 2.1 (b) and 2.2(b) are revoked effective as of the date you first made, used, sold, distributed, or had made, modifications made by that participant.

- 8.3. If you assert a patent infringement claim against participant alleging that such participant's contributor version directly or indirectly infringes any patent where such claim is resolved (such as by license or settlement) prior to the initiation of patent infringement litigation, then the reasonable value of the licenses granted by such participant under sections 2.1 or 2.2 shall be taken into account in determining the amount or value of any payment or license.
- 8.4. In the event of termination under sections 8.1 or 8.2 above, all end user license agreements (excluding distributors and resellers) which have been validly granted by you or any distributor hereunder prior to termination shall survive termination.

## 9. LIMITATION OF LIABILITY.

UNDER NO CIRCUMSTANCES AND UNDER NO LEGAL THEORY, WHETHER TORT (INCLUDING NEGLIGENCE), CONTRACT, OR OTHERWISE, SHALL YOU, THE INITIAL DEVELOPER, ANY OTHER CONTRIBUTOR, OR ANY DISTRIBUTOR OF COVERED CODE, OR ANY SUPPLIER OF ANY OF SUCH PARTIES, BE LIABLE TO ANY PERSON FOR ANY INDIRECT, SPECIAL, INCIDENTAL, OR CONSEQUENTIAL DAMAGES OF ANY CHARACTER INCLUDING, WITHOUT LIMITATION, DAMAGES FOR LOSS OF GOODWILL, WORK STOPPAGE, COMPUTER FAILURE OR MALFUNCTION, OR ANY AND ALL OTHER COMMERCIAL DAMAGES OR LOSSES, EVEN IF SUCH PARTY SHALL HAVE BEEN INFORMED OF THE POSSIBILITY OF SUCH DAMAGES. THIS LIMITATION OF LIABILITY SHALL NOT APPLY TO LIABILITY FOR DEATH OR PERSONAL INJURY RESULTING FROM SUCH PARTY'S NEGLIGENCE TO THE EXTENT APPLICABLE LAW PROHIBITS SUCH LIMITATION. SOME JURISDICTIONS DO NOT ALLOW THE EXCLUSION OR LIMITATION OF INCIDENTAL OR CONSEQUENTIAL DAMAGES, SO THIS EXCLUSION AND LIMITATION MAY NOT APPLY TO YOU.

## 10. U.S. GOVERNMENT END USERS.

The covered code is a "commercial item," as that term is defined in 48 C.F.R. 2.101 (Oct. 1995), consisting of "commercial computer software" and "commercial computer software documentation," as such terms are used in 48 C.F.R. 12.212 (Sept. 1995). Consistent with 48 C.F.R. 12.212 and 48 C.F.R. 227.7202-1 through 227.7202-4 (June 1995), all U.S. Government end users acquire covered code with only those rights set forth herein.

11. MISCELLANEOUS.

This license represents the complete agreement concerning subject matter hereof. If any provision of this license is held to be unenforceable, such provision shall be reformed only to the extent necessary to make it enforceable. This License shall be governed by California law provisions (except to the extent applicable law, if any, provides otherwise), excluding its conflict-of-law provisions. With respect to disputes in which at least one party is a citizen of, or an entity chartered or registered to do business in the united states of america, any litigation relating to this License shall be subject to the jurisdiction of the federal courts of the northern district of california, with venue lying in santa clara county, california, with the losing party responsible for costs, including without limitation, court costs and reasonable attorneys' fees and expenses. The application of the united nations convention on contracts for the International sale of goods is expressly excluded. Any law or regulation which provides that the language of a contract shall be construed against the drafter shall not apply to this license.

12. RESPONSIBILITY FOR CLAIMS.

As between initial developer and the contributors, each party is responsible for claims and damages arising, directly or indirectly, out of its utilization of rights under this license and you agree to work with initial developer and contributors to distribute such responsibility on an equitable basis. Nothing herein is intended or shall be deemed to constitute any admission of liability.

13. MULTIPLE-LICENSED CODE.

Initial developer may designate portions of the covered code as "Multiple-Licensed". "Multiple-Licensed" means that the initial developer permits you to utilize portions of the covered code under your choice of the NPL or the alternative licenses, if any, specified by the initial developer in the file described in exhibit A.

EXHIBIT A -Mozilla Public License.

The contents of this file are subject to the Mozilla Public License Version 1.1 (the "license"); you may not use this file except in compliance with the License. You may obtain a copy of the license at <http://www.mozilla.org/MPL/>

Software distributed under the license is distributed on an "AS IS" basis, WITHOUT WARRANTY OF ANY KIND, either express or implied. See the license for the specific language governing rights and limitations under the License.

The Original Code is \_\_\_\_\_.

The Initial Developer of the Original Code is \_\_\_\_\_.

Portions created by \_\_\_\_\_ are Copyright (C) \_\_\_\_\_ All Rights Reserved.

Contributor(s): \_\_\_\_\_.

Alternatively, the contents of this file may be used under the terms of the \_\_\_\_\_ license (the "[ ] License"), in which case the provisions of [ ] license are applicable instead of those above. If you wish to allow use of your version of this file only under the terms of the [ ] license and not to allow others to use your version of this file under the MPL, indicate your decision by deleting the provisions above and replace them with the notice and other provisions required by the [ ] license. If you do not delete the provisions above, a recipient may use your version of this file under either the MPL or the [ ] license."

NOTE: The text of this exhibit A may differ slightly from the text of the notices in the source code files of the original code. You should use the text of this exhibit A rather than the text found in the original code/source code for Your modifications.

---

# COMMERCIAL MODE SETUP GUIDE

---

Note: All features shown within this guide may not be available on all models.

## EXPERIENCED INSTALLER

Commercial Mode Setup  
page 7

B-LAN Setup  
page 45

Cloning Information  
pages 21 - 25

For Customer Support/Service, please call:

**1-888-865-3026**

www.lgcommercial.com • www.zenith.com

RECORD Model and SERIAL NUMBER

The model and serial number of this TV is located on the back of the cabinet. For future reference, we suggest that you record those numbers here:

Model No. \_\_\_\_\_ Serial No. \_\_\_\_\_



**WARNING:** TO REDUCE THE RISK OF ELECTRIC SHOCK DO NOT REMOVE COVER (OR BACK). NO USER SERVICEABLE PARTS INSIDE. REFER TO QUALIFIED SERVICE PERSONNEL



The lightning flash with arrowhead symbol, within an equilateral triangle, is intended to alert the user to the presence of uninsulated "dangerous voltage" within the product's enclosure that may be of sufficient magnitude to constitute a risk of electric shock to persons.



The exclamation point within an equilateral triangle is intended to alert the user to the presence of important operating and maintenance (servicing) instructions in the literature accompanying the appliance

**WARNING:**

TO PREVENT FIRE OR SHOCK HAZARDS, DO NOT EXPOSE THIS PRODUCT TO RAIN OR MOISTURE.

**POWER CORD POLARIZATION:**

This product is equipped with a 3-wire grounding-type alternating current line plug. This plug will fit into the power outlet only one way. This is a safety feature. If you are unable to insert the plug fully into the outlet, contact your electrician to replace your obsolete outlet. Do not defeat the safety purpose of the three-wire ground type plug.

**NOTE TO CABLE/TV INSTALLER:**

This reminder is provided to call the cable TV system installer's attention to Article 820-40 of the National Electric Code (U.S.A.). The code provides guidelines for proper grounding and, in particular, specifies that the cable ground shall be connected to the grounding system of the building, as close to the point of the cable entry as practical.

**REGULATORY INFORMATION:**

This equipment has been tested and found to comply with the limits for a Class B digital device, pursuant to Part 15 of the FCC Rules. These limits are designed to provide reasonable protection against harmful interference when the equipment is operated in a residential installation. This equipment generates, uses and can radiate radio frequency energy and, if not installed and used in accordance with the instruction manual, may cause harmful interference to radio communications. However, there is no guarantee that interference will not occur in a particular installation. If this equipment does cause harmful interference to radio or television reception, which can be determined by turning the equipment off and on, the user is encouraged to try to correct the interference by one or more of the following measures:

- Reorient or relocate the receiving antenna.
- Increase the separation between the equipment and receiver.
- Connect the equipment into an outlet on a circuit different from that to which the receiver is connected.
- Consult the dealer or an experienced radio/TV technician for help.

**CAUTION:**

Do not attempt to modify this product in any way without written authorization from LG Electronics U.S.A., Inc. Unauthorized modification could void the user's authority to operate this product.

**COMPLIANCE:**

The responsible party for this product's compliance is: LG Electronics U.S.A., Inc.  
1000 Sylvan Avenue, Englewood Cliffs, NJ 07632, USA • Phone: 1-201-816-2000.

Marketed and Distributed in the United States by LG Electronics U.S.A., Inc.  
2000 Millbrook Drive, Lincolnshire, IL 60069

© Copyright 2009, LG Electronics U.S.A., Inc.

# IMPORTANT SAFETY INSTRUCTIONS

## SAFETY INSTRUCTIONS

### Important safeguards for you and your new product

This product has been manufactured and tested with safety in mind. However, improper use can result in potential electrical shock or fire hazards. To avoid defeating the safeguards that have been built into the new product, please read and observe the following safety points when installing and using the new product, and save them for future reference.

Observing the simple precautions discussed in this installation and operating guide can help get many years of enjoyment and safe operation that are built into the new product.

This product complies with all applicable U.S. Federal safety requirements, and those of the Canadian Standards Association

### 1. Read Instructions

All the safety and operating instructions should be read before the product is operated.

### 2. Follow Instructions

All operating and use instructions should be followed.

### 3. Retain Instructions

The safety and operating instructions should be retained for future reference.

### 4. Heed Warnings

All warnings on the product and in the operating instructions should be adhered to.

### 5. Cleaning

Unplug this product from the wall outlet before cleaning. Do not use liquid cleaners or aerosol cleaners. Use a damp cloth for cleaning.

### 6. Water and Moisture

Do not use this product near water for example, near a bath tub, wash bowl, kitchen sink, or laundry tub, in a wet basement, or near a swimming pool.

### 7. Accessories, Carts, and Stands

Do not place this product on a slippery or tilted surface, or on an unstable cart, stand, tripod, bracket, or table. The product may slide or fall, causing serious injury to a child or adult, and serious damage to the product. Use only with a cart, stand, tripod, bracket, or table recommended by the manufacturer, or sold with the product. Any mounting of the product should follow the manufacturer's instructions, and should use a mounting accessory recommended by the manufacturer.



PORTABLE CART WARNING

### 8. Transporting Product

A product and cart combination should be moved with care. Quick stops, excessive force, and uneven surfaces may cause the product and cart combination to overturn.

### 9. Attachments

Do not use attachments not recommended by the product manufacturer as they may cause hazards.

### 10. Ventilation

Slots and openings in the cabinet are provided for ventilation and to ensure reliable operation of the product and to protect it from overheating, and these openings must not be blocked or covered. The openings should never be blocked by placing the product on a bed, sofa, rug, or other similar surface. This product should not be placed in a built-in installation such as a bookcase or rack unless proper ventilation is provided or the manufacturer's instructions have been adhered to.

### 11. Power Sources

This product should be operated only from the type of power source indicated on the marking label. If you are not sure of the type of power supply to your home, consult your product dealer or local power company. For products intended to operate from battery power, or other sources, refer to the operating instructions.

### 12. Power Cord Polarization (Some models)

This product is equipped with a three-wire grounding type alternating-current power plug. This plug will fit into the power outlet only one way. This is a safety feature. If you are unable to insert the plug fully into the outlet, contact your electrician to replace your obsolete outlet. Do not defeat the safety purpose of the three-wire ground-type plug.

### 13. Power Cord Protection

Power-supply cords should be routed so that they are not likely to be walked on or pinched by items placed upon or against them, paying particular attention to cords at plugs, convenience receptacles, and the point where they exit from the product.



# IMPORTANT SAFETY INSTRUCTIONS

(Continued from previous page)

## 14. Outdoor Antenna Grounding

If an outside antenna or cable system is connected to the product, be sure the antenna or cable system is grounded so as to provide some protection against voltage surges and built-up static charges. Article 810 of the National Electrical Code (U.S.A.), ANSI/ NFPA 70 provides information with regard to proper grounding of the mast and supporting structure, grounding of the lead-in wire to an antenna discharge unit, size of grounding conductors, location of antenna-discharge unit, connection to grounding electrodes, and requirements for the grounding electrode.

### Example of Grounding According to National Electrical Code Instructions

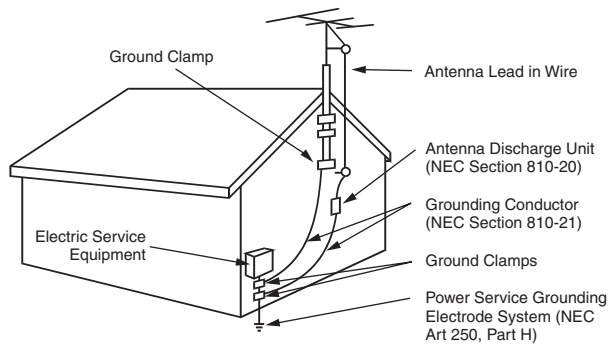

NEC - National Electrical Code

## 15. Lightning

For added protection for this product (receiver) during a lightning storm, or when it is left unattended and unused for long periods of time, unplug it from the wall outlet and disconnect the antenna or cable system. This will prevent damage to the product due to lightning and power-line surges.

## 16. Power Lines

An outside antenna system should not be located in the vicinity of overhead power lines or other electric light or power circuits, or where it can fall into such power lines or circuits. When installing an outside antenna system, extreme care should be taken to keep from touching such power lines or circuits as contact with them might be fatal.

## 17. Overloading

Do not overload wall outlets and extension cords as this can result in a risk of fire or electric shock.

## 18. Object and Liquid Entry

Never push objects of any kind into this product through openings as they may touch dangerous voltage points or

short-out parts that could result in a fire or electric shock. Never spill liquid of any kind on the product.

## 19. Servicing

Do not attempt to service this product yourself as opening or removing covers may expose you to dangerous voltage or other hazards. Refer all servicing to qualified service personnel.

## 20. Damage Requiring Service

Unplug this product from the wall outlet and refer servicing to qualified service personnel under the following conditions:

- If the power-supply cord or plug is damaged.
- If liquid has been spilled, or objects have fallen into the product.
- If the product has been exposed to rain or water.
- If the product does not operate normally by following the operating instructions. Adjust only those controls that are covered by the operating instructions as an improper adjustment of other controls may result in damage and will often require extensive work by a qualified technician to restore the product to its normal operation.
- If the product has been dropped or the cabinet has been damaged.
- If the product exhibits a distinct change in performance.

## 21. Replacement Parts

When replacement parts are required, be sure the service technician has used replacement parts specified by the manufacturer or have the same characteristics as the original part. Unauthorized substitutions may result in fire, electric shock, or other hazards.

## 22. Safety Check

Upon completion of any service or repairs to this product, ask the service technician to perform safety checks to determine that the product is in proper operating condition.

## 23. Wall or Ceiling Mounting

The product should be mounted to a wall or ceiling only as recommended by the manufacturer. The product may slide or fall, causing serious injury to a child or adult, and serious damage to the product.

## 24. Heat

The product should be situated away from heat sources such as radiators, heat registers, stoves, or other products (including amplifiers) that produce heat.

Use this page as a reference to find pages or sections to go to and set up the TV features.  
Go to page 7 to begin the Commercial Mode Master TV setup.

Warnings . . . . .	2	Installer Menus . . . . .	26 - 27 - 28 - 29 - 30 - 31
Important Safety Instructions . . . . .	3 - 4	<b>References</b>	
Table of Contents . . . . .	5	Detailed Instructions For Making A Master TV . . . . .	32
Setup Checklist . . . . .	6	Editing Channel Icons/Adding Ch Labels 2-5-4 + Menu Mode 33	
<b>Commercial Mode Setup for Master TV . . . . .</b>	<b>7</b>	Clonable Menu Features / Checking Software Version . . . . .	34
Installer Overview . . . . .	8	USB End User Features . . . . .	35
FTG Card Mode of Operation Overview . . . . .	9	USB Cloning Setup: Master TV Learning . . . . .	36
FTG Card Operation Setup . . . . .	10	USB Cloning Setup: Master TV Teaching . . . . .	37
FTG Card Channel Map Overview . . . . .	11	TV Camport Auto Sense Operation . . . . .	38
FTG Installer Menu Overview . . . . .	12	TV Aux Input Configuration / Troubleshooting . . . . .	39
FTG Operation Troubleshooting . . . . .	13	Troubleshooting . . . . .	40
Typical Installer's Remote Control . . . . .	14	LT2002 Cloning Troubleshooting . . . . .	41
Installer Remote Control Key Functions . . . . .	15	Troubleshooting Flow Chart . . . . .	42
Rear Connections Panel . . . . .	16	Commercial Mode Check . . . . .	43
A/V Input 2 Side Connections Panel/RF Antenna Connection	17	Glossary of Terms . . . . .	44
RJP / TV Connections & Setup . . . . .	18	B-LAN Setup and Overview . . . . .	45
MPI Card Slot / PPV Card Installation . . . . .	19	RJP Model List and Input Hierarchy . . . . .	46
TV Features Configuration Menus Overview . . . . .	20	Notes . . . . .	47
TLL-1100A Cloning Instructions / Learning Setup . 21 -22 - 23		Back Cover . . . . .	48
LT2002 Cloning Instructions . . . . .	24 - 25		

**Notes**

- See the Installer's menus to set up the operational features of the TV. The Installer's section content is intended to be used primarily by qualified TV electronics technicians.
- Reference is made to installer remote controls used for menu operation within the manual. The remote information is provided for reference only. The typical installer remote control shown for reference in this manual may be different than the actual remote control supplied with the TV.
- For any additional information, contact your LG representative.

Note: Design and specifications are subject to change without prior notice.

Marketed and Distributed in the United States by LG Electronics U.S.A., Inc.  
1000 Sylvan Avenue  
Englewood Cliffs, NJ 07632

For Customer Support/Service please call:

**1-888-865-3026**

www.lgcommercial.com

# Setup Checklist

## Installation and Setup Checklist

- Unpack TV and all accessories.
- Install batteries in remote control.
- Install TV on Vesa Mount or Stand.  
Note: It may be advisable to make all hard-wire connections before installing on Vesa mount or stand, as appropriate.

## Hardware Connections

- Install any additional hardware as appropriate to your institution, LAN etc.

## Hardwire Connections

- Make all connections to rear Jack Pack and RF antenna on MPI card.
- Make all connections to signal, interactive resources and Aux sources as appropriate.

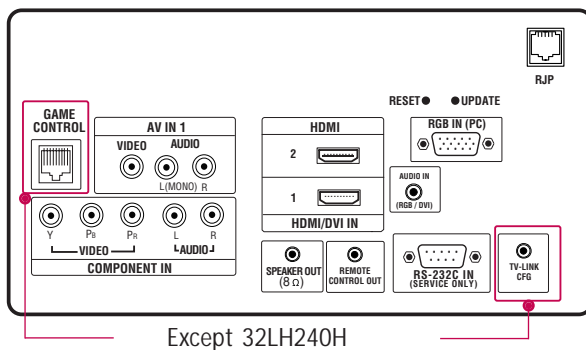

## Installer Menu Items Setup

- Configure all relevant Installer menu items as required of your institution.

## TV Menus Configuration

Configure TV features for the end user.

- Channel
- Picture
- Audio
- Option
- Time
- Lock
- Choose on screen menu language.  
(English is the default language.)

## Commercial Mode Setup

- Commercial Mode Setup, see next page.

## Software Installation

- Install or configure any software as applicable; PPV etc.

## Additional Features Setup

See page 5, Table of Contents.

- Select viewing source on TV.

This page provides an overview of a Master TV configuration.

**Note 1:** Disconnect all Aux inputs. Under certain conditions, Auto Tuning (Channel search) is disabled if there is an Aux input active.

## Commercial Mode Setup Procedure

### 1. Set Installer Menu Items

(Enter TV Installer Menu, see Installer menus for detailed instructions.)

- Set Installer menu item **117 FACT DEFAULT**, to **001** and press **ENTER** on Installer remote. (This clears all installer menu custom settings, channel labels / icons etc. and reloads the factory default settings.)
- Set Item **003 BAND/AFC**.
  - **Broadcast:** set to **000**.      - **HRC:** set to **002**
  - **CATV:** set to **001**.            - **IRC:** set to **003**
- Set item **028 CH OVERRIDE** to **001**. This allows access to channel search, Auto Tuning and Channel List/Edit options in the Channel Menu.
- Set other particular installer items that affect your TV programming network. Enable/Disable Aux sources, set a **Start Channel** etc.
- After all required installer menu item settings have been adjusted, press **ENTER** on the remote to remove Installer Menu.

### 2. Set Up TV Features

(Channel, Picture, Audio, Lock, Time, Option, Digital Captions etc. See TV Clonable options list and TV menus pages.)

### 3. Run Auto Tuning (Channel Search)

(Search for all available channels.) Go to the Channel Menu and access the Auto Tuning option, follow onscreen instructions.

- Edit Channel Scan. In the Channel Menu, access Channel Edit option.
- Add/Delete channels per your system requirements.
  - Note: Physical channel numbers are used to identify Virtual channels.
  - Add familiar channel trademarks/logos like ABC, CBS, NBC etc. to the Channel-Time onscreen display. In the Channel menu, select the Channel Label option. Add identifiable labels (logos) for the end user to readily know what common networks are available.

### 4. Transfer TV Setup to Internal TV Controller: 2-5-5 + Menu Mode

After the TV channel scan has been edited and channel label icons added, enter the Installer menu. Once in the Installer menu, press 2-5-5 and MENU on the remote. This transfers the TV setup to the internal controller box.

### 5. Add Custom Channel Labels for Analog Channels: 2-5-4 + Menu Mode

Enter Installer menu, press 2-5-4 and MENU. Add your own custom text labels to channel onscreen displays. Note: Digital Channels often have a broadcaster generated label. (See 2-5-4+Menu pages.)

When finished, to exit 2-5-4+Menu mode, press **MENU**.

### Verify TV Setup

At this point, verify that the channel lineup, channel icons and custom labels are correct. Make sure the TV features are set per your requirements. Set item **028 Ch Override** to **000** to lock the channel scan. After the preceding has been completed, the Master TV setup is ready to be copied to a Clone Programmer, see cloning options pages.

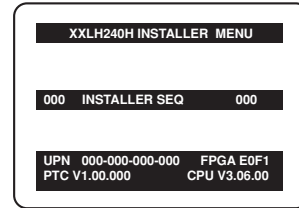

For 32LH240H

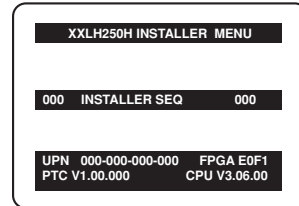

For 32/37/42LH250H,  
32/37/42LH255H

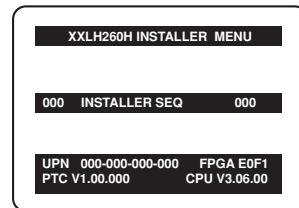

For 37/42LH260H  
37LH265H

Typical TV Installer Menu

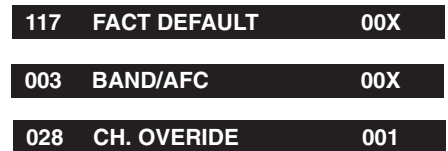

Adjust the settings for these  
Installer Menu Items

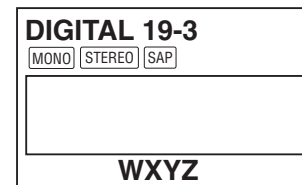

Custom Text Label 'WXYZ' created in  
2-5-4 + Menu (Add Channel Label) Mode



Set 093 RJP Available to 001 if using a remote  
jack pack



After Master TV setup has been completed,  
set item 028 Ch Override to 000.

This is the commercial mode setup guide only.

## Operating Installer Menu

To set up the controls for the TV you will need to know how to enter the TV Installer menu and make changes to the default values as required. If necessary, familiarize yourself with the TV Installer menu and how to make and save changes in the menu.

## LG Installer Remote

You will need an **LG Installer remote** control similar to the one shown to the right. The installer remote must have a "Source" button or its equivalent. The remote shown in this manual has "INPUT" -- this button serves the purpose of a Source button.

The TV's clonable features need to be set up. This is a critical step. If the Master TV display panel's clonable features like adding channel icons or channel labels are not done correctly, then the cloned TVs will all have problems. Refer to the Owner's Manual for other TV features: Video, Audio, Closed Captions, V-Chip, etc.

## TLL-1100A Clone Programmer

The TLL is a very simple cloner to use. It can be set up to clone a master TV setup and transfer it into a target TV. Cloning is accomplished using the TV/Cloner MPI ports for communication. Be sure the Master TV is set up completely. Cloning is only possible when the TV is tuned to an Aux source or Analog channel, not a digital channel.

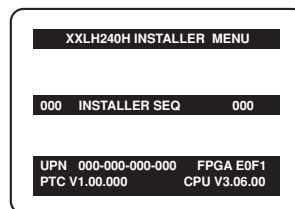
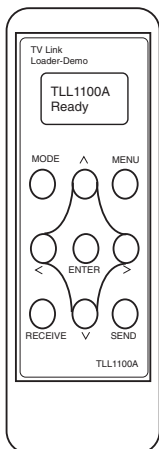

For 32LH240H

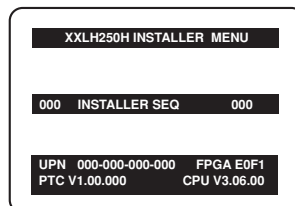

For 32/37/42LH250H,  
32/37/42LH255H

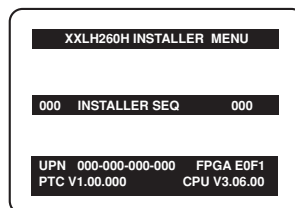

For 37/42LH260H  
37LH265H

Typical

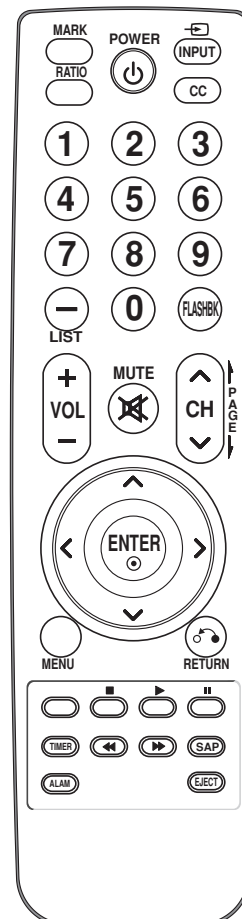

Outlined below is the FTG (Free-To-Guest) setup for individual TV control

1. Set up commercial features of TV/STB. Enter Installer Menu and set all desired items as required. (i.e. Tuning Band, Start Channel etc.) Refer to the Installation and Setup Guide of the TV/STB.
2. Load the FTG Configuration Application program onto the PC that will be used to configure the FTG card.
3. Install FTG card into TV/STB's MPI card slot and connect PC. (See below)
4. Execute the FTG Configuration Application and create a configuration file.
5. Build a Channel Map and 'Write' it to FTG card. (Converts card from pass-through to FTG mode.)
6. If necessary, make changes to Installer Menu items using FTG Installer Menu Configuration utility and 'Write' them to FTG card.
7. Save the configuration file (\*.rml) for future use.
8. Tune TV/STB to a Logical Channel in the Channel Map.

## LMT7Z7 Configured Card in FTG Mode of Operation

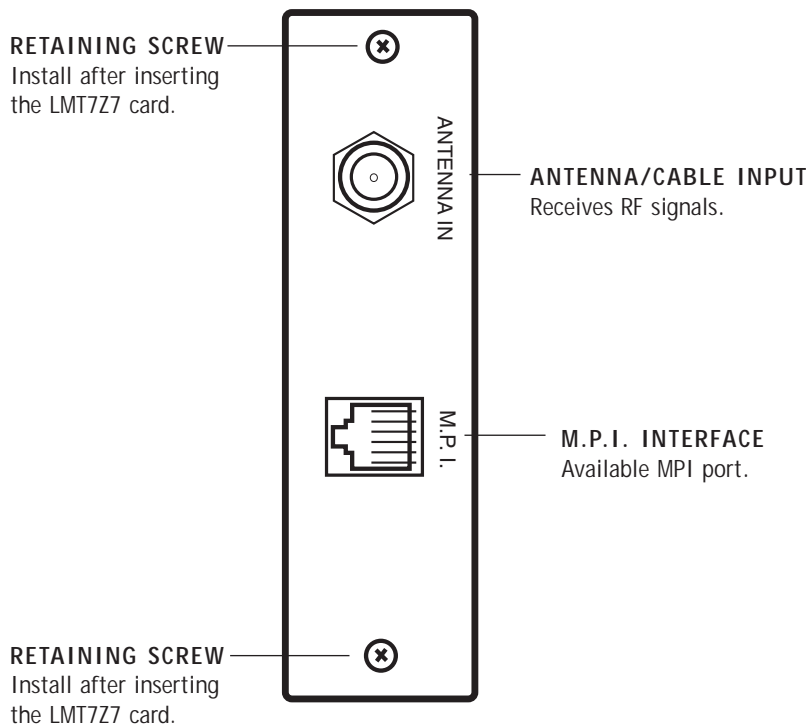
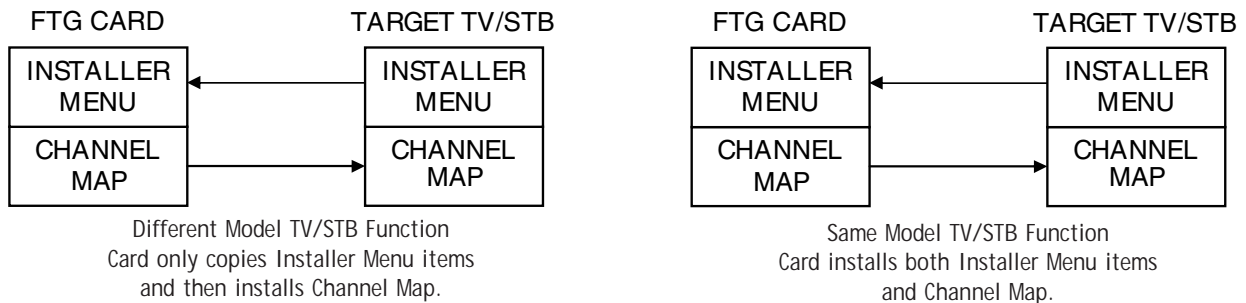

## FTG Card Mode of Operation Contd.

It is easy to determine the operating mode of the TV/STB. By pressing Menu, if the Setup or TV menu appears, the Z7 card is in pass-through mode. If the End User 'Function' menu appears, the TV/STB is in FTG mode.

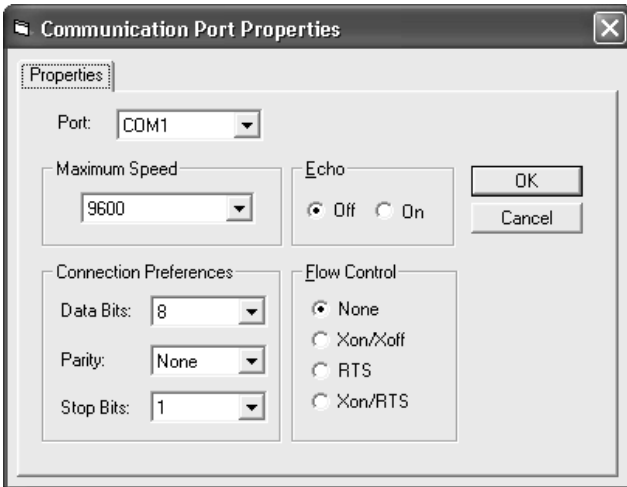

### Communications Setup Menu

Sets up the communications link between the FTG Configuration Application and the Z7 card installed in a TV/STB.

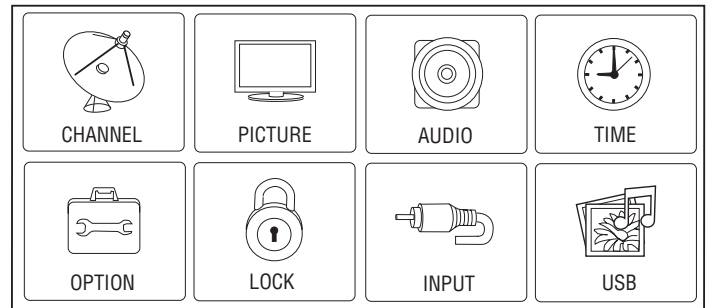

### Typical TV/STB Setup Menu

Shows that the Z7 card is in pass-through mode. This menu can also be accessed by turning IR remote access 'On' in the FTG Configuration Application, while the TV/STB is in FTG mode.

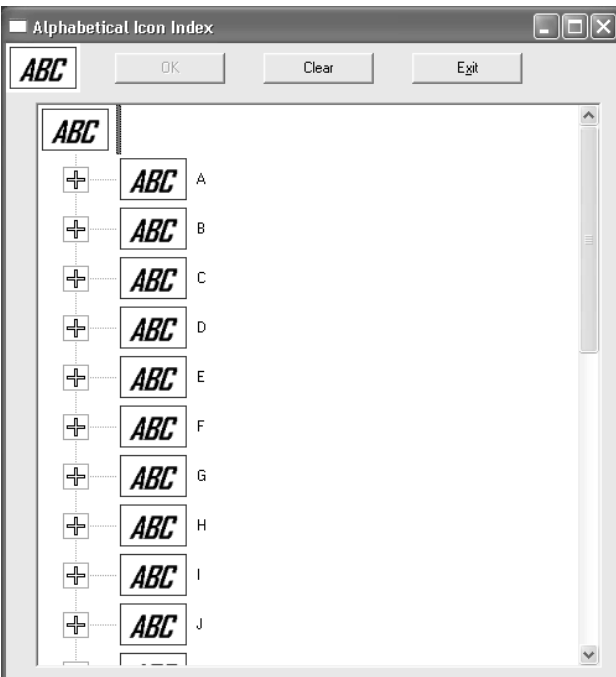

### Network Icon Selection Menu

Select channel icons like ABC, NBC etc., to add to the channel OSDs to identify common networks for the end user.

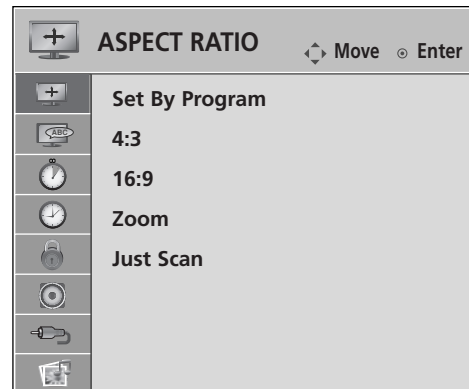

### End User 'Aspect Ratio' or Function Menu

Shows that the Z7 card is in FTG mode. While this menu is present on-screen, the only way the Installer menu can be accessed is by the FTG Configuration Application.

# FTG Channel Map Overview

Creating/copying a channel map into LMT7Z7 card will convert the card from pass-through mode to FTG mode. When 'Aspect Ratio' menu is present, card is in FTG mode.

## LOGICAL CHANNEL NUMBERS

Channels appear in numerical order. Select logical, Major and Minor numbers on menu.

## CUSTOM CHANNEL LABELS/ICONS

Set custom labels and select icons on menu.

## SET CHANNEL ATTRIBUTES

Set encrypted, OSD on or off or blank video only.

Logical Channel	Physical Channel	Major Channel	Minor Channel	Channel Label	Channel ICON	Attribute
2	2	2	0	WBBM-TV	14 - CBS	0
5	5	5	0	WMAQ-TV	15 - NBC	0
7	7	7	0	WLS-TV	13 - ABC	0
9	9	9	0	WGN-TV	89 - WGN	0
11	11	11	0	wTTW	17 - PBS	0
14	31	31	3	FOX	16 - FOX	0
15	19	19	3	WGN	89 - WGN	0
16	47	47	4	KIDS	133 - PBS Kids	0
17	27	27	3	THE U	174 - UPN	0
40	65	65	1	HBO-HD	12 - HBO	EO
41	66	66	1	ESPN-HD	2 - ESPN	EO
42	67	67	1	ESPN2HD	21 - ESPN2	EO
43	68	68	1	TNT-HD	4 - TNT	EO
44	69	69	1	HDNET	161 - HDNet	EO
52	74	74	1	STARZHD	33 - Starz	EO
62	75	75	1	WISN-TV	12 - WISN	EO

## CHANNEL MAP EDITOR

Shows both channel data and logical channel lineup.

## EXIT

Exits menu and returns to logical channel listing.

## DELETE

Removes channel from lineup.

## ADD

After inputting a new channel's data, press to add channel to list.

## UPDATE

After editing a channel's data, press to include the changes in the channel list.



# FTG Installer Menu Overview

**CONFIGURATION SETTINGS**  
Select tabs for Installer submenu items to set up TV/STB.

**HOSPITAL GRADE TV/STB ITEMS**  
Set hospital only items on Installer menu for Hospital grade TV/STBs.

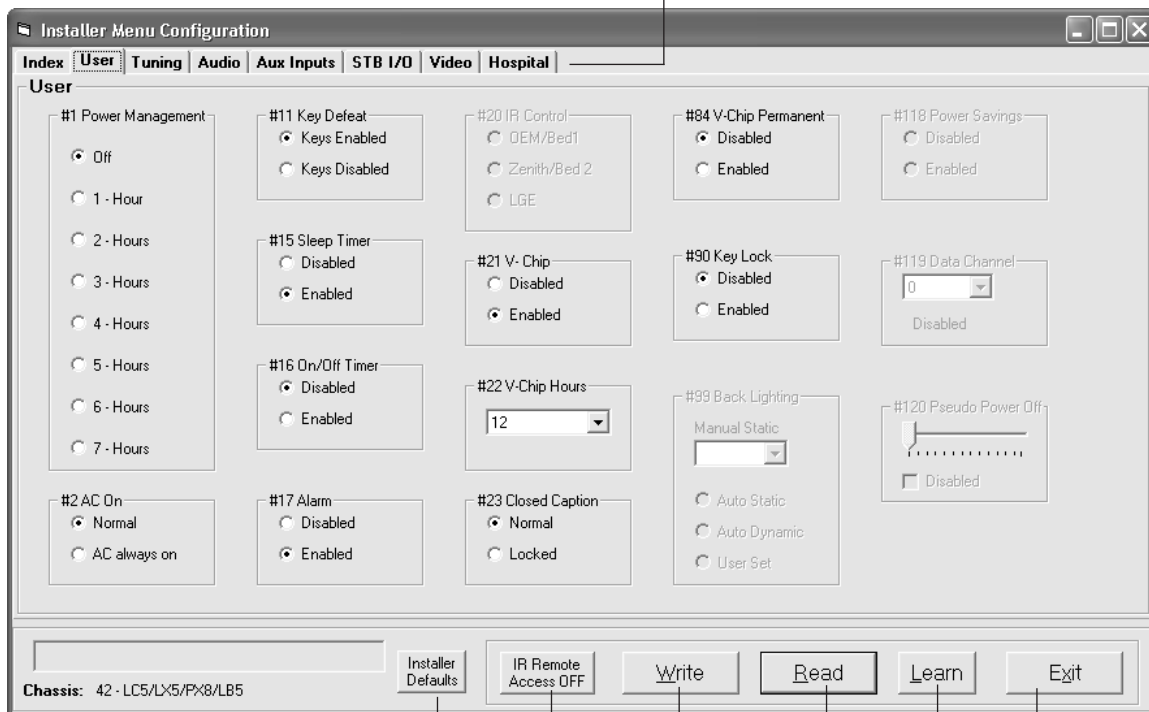

**INSTALLER DEFAULTS**  
Press to reset TV/STB to Installer menu defaults.

**IR REMOTE ACCESS**  
Toggle IR remote access to On to get access to TV/STB feature menus or Installer menu.

**WRITE**  
Press to transfer the FTG Installer menu values to the FTG card and TV/STB.

**READ**  
Press to transfer the Installer menu values on the FTG card to the PC FTG Configuration Application.

**EXIT**  
Returns to logical channel map menu.

**LEARN**  
Press to transfer the installer menu settings on the TV/STB to the FTG card and PC FTG Configuration Application.

## LMT7Z7 Configured Card in FTG Mode of Operation

### Error Messages

<b>Problem</b>	<b>Probable Cause</b>	<b>Solution</b>
Cannot contact target.	FTG application already open.	Close extra FTG application on computer.
	Cable(s) not connected.	Check and connect communication cables.
	TV off.	Turn TV on.
	Wrong Communication port.	Select correct Comm port on computer.

# Typical Installer Remote Control

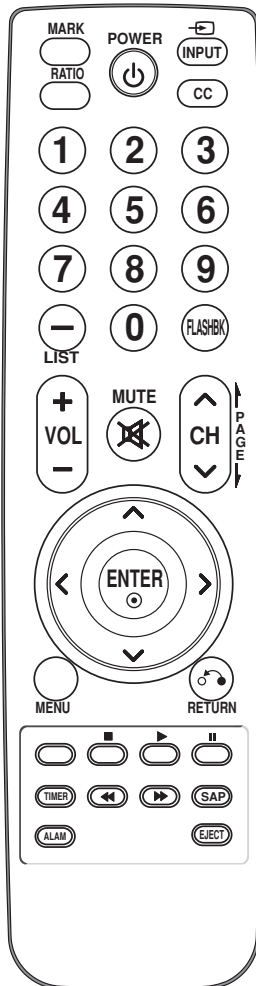

## *LG Installer Remote Control*

*The remote control is supplied with and dedicated to operate the TV. Some DVD and VCR controls may be available for some LG DVD/VCR products.*

*See next page for typical key functions in TV mode and DVD/VCR control.*

*Follow the instructions provided in the Installer menu pages to access the Installer menus.*

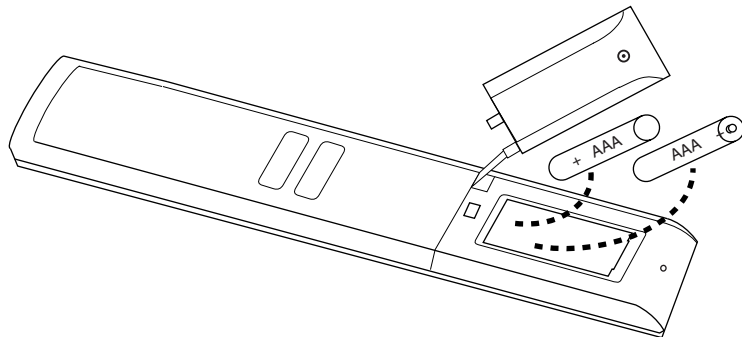

### **Installing Batteries in Installer Remote Control**

- Remove the battery compartment cover on the back side by loose the bolt on the battery compartment cover, pressing the arrow tab and sliding the cover downward. Install batteries matching correct polarity as shown (+ with + and - with -).
- Install two high-quality alkaline 1.5V AAA batteries. Never mix old or used batteries with new ones. Replace cover.

# Installer Remote Control Typical Key Functions

Remote Control Key Functions: This typical LG TV remote control is shown for reference. Follow the instructions provided on the Installer menu pages to access the Installer menu.

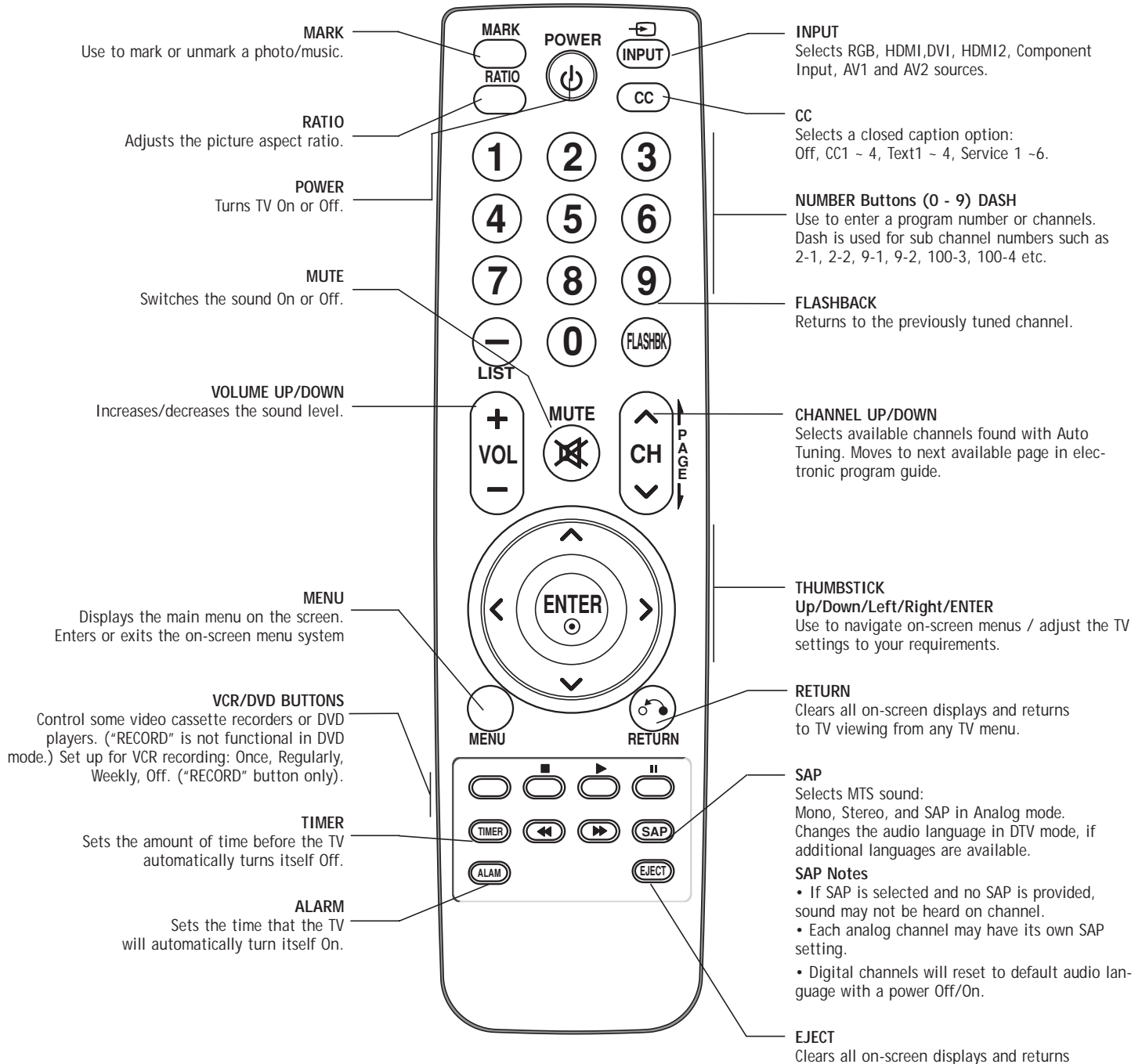

# Rear Connections Panel

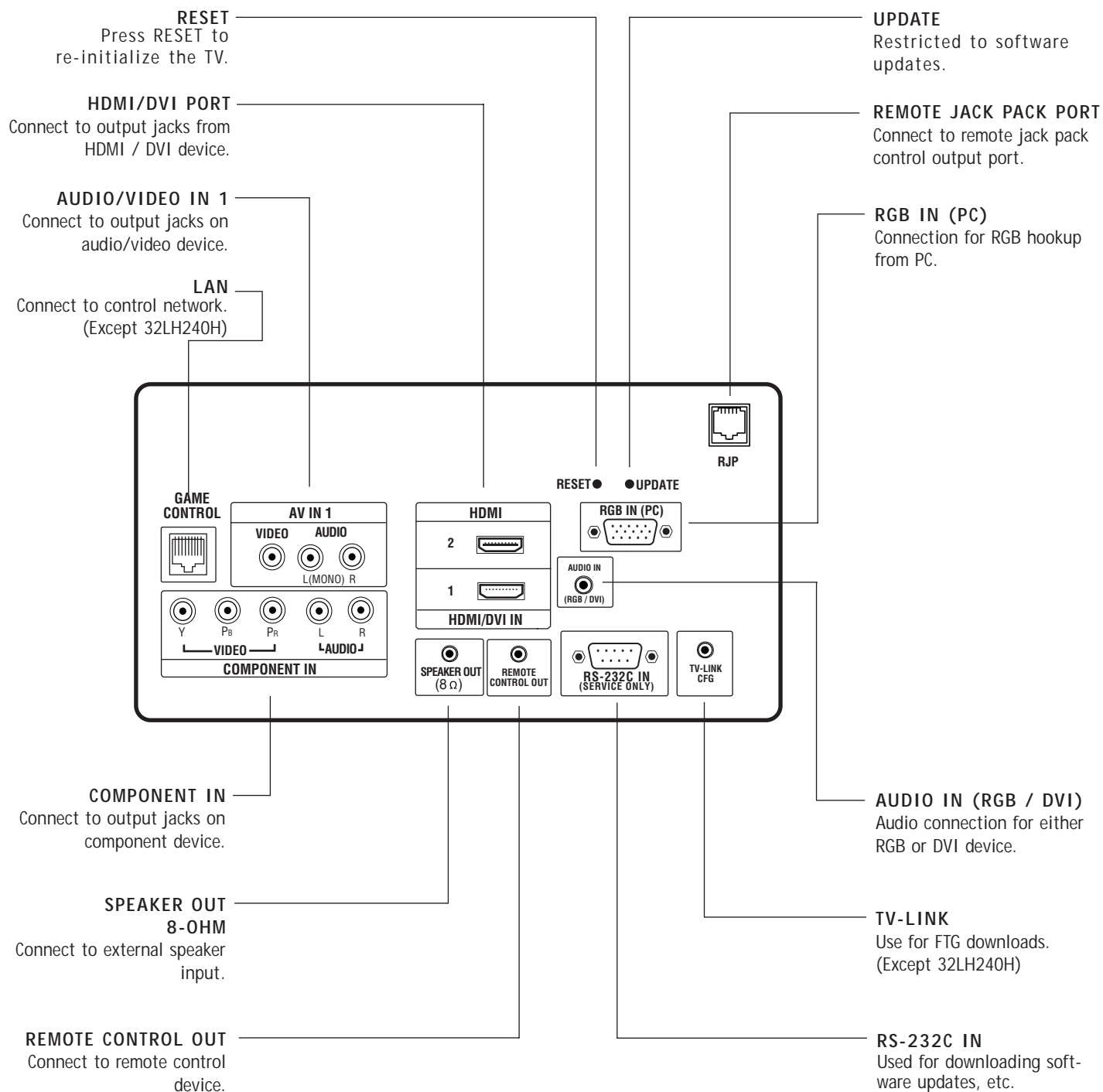

# A/V 2 Input: Side Connections Panel / RF Antenna Connection

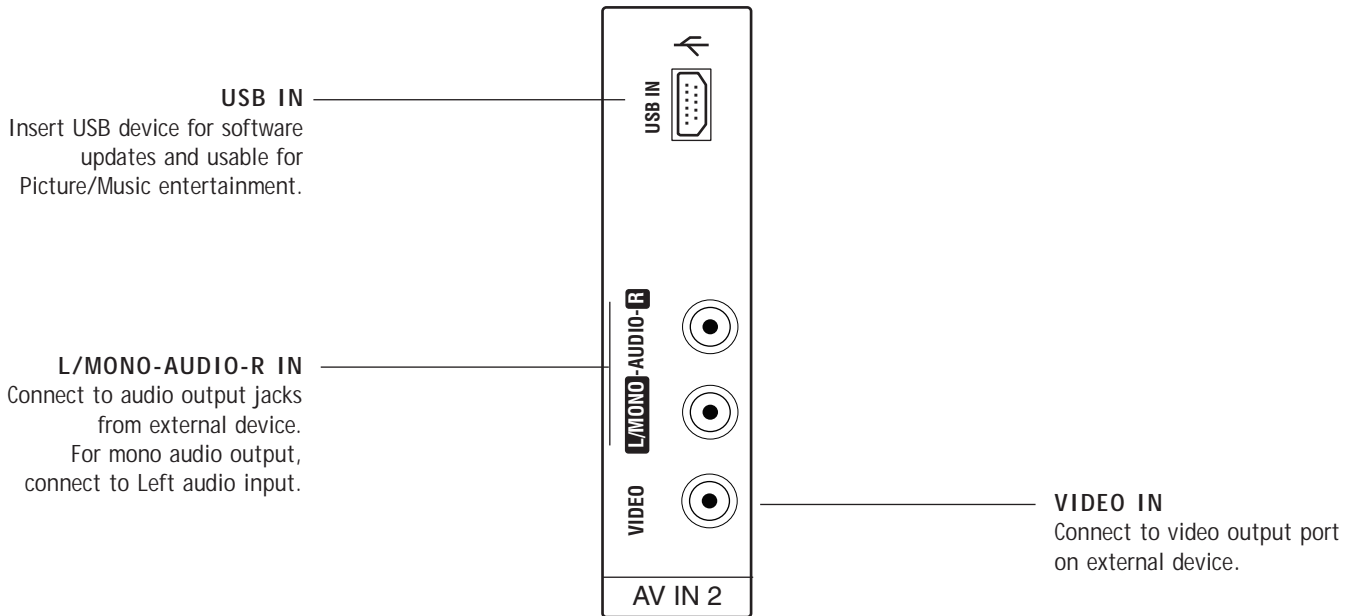

## RF Antenna Connection

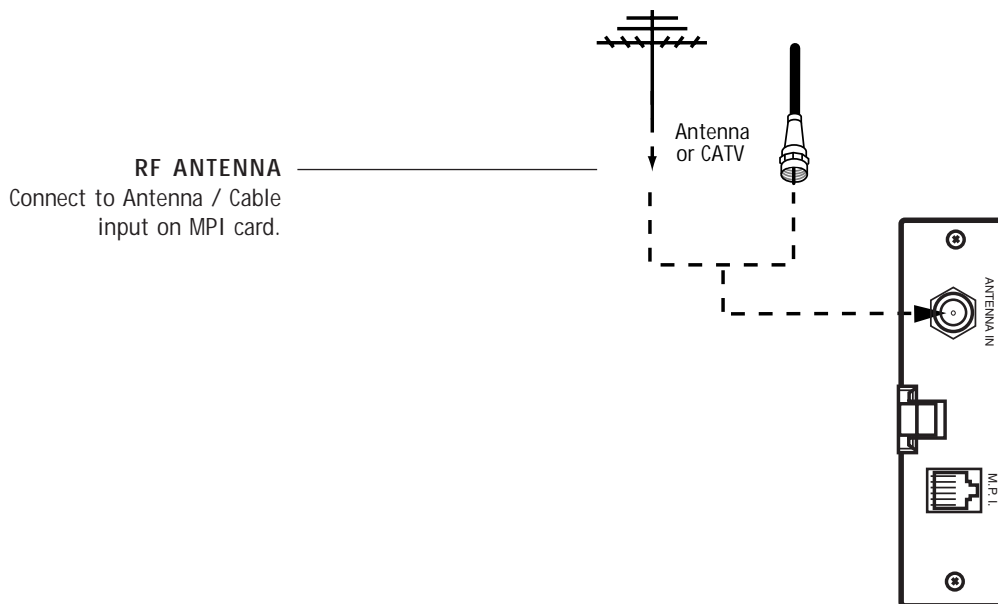

# Remote Jack Pack (RJP) / TV Connections after Commercial Mode Setup and Cloning Master TV Setup Procedures

Make these connections after commercial mode setup and cloning procedures are complete

## Remote Jack Pack Setup

- RJP Available? If you will use a remote jack pack in your system, set installer item 093 RJP Available to 001 so the RJP function is enabled.  
Note: Make RJP connections first then set 093 to 001.

**093 RJP AVAILABLE 001**

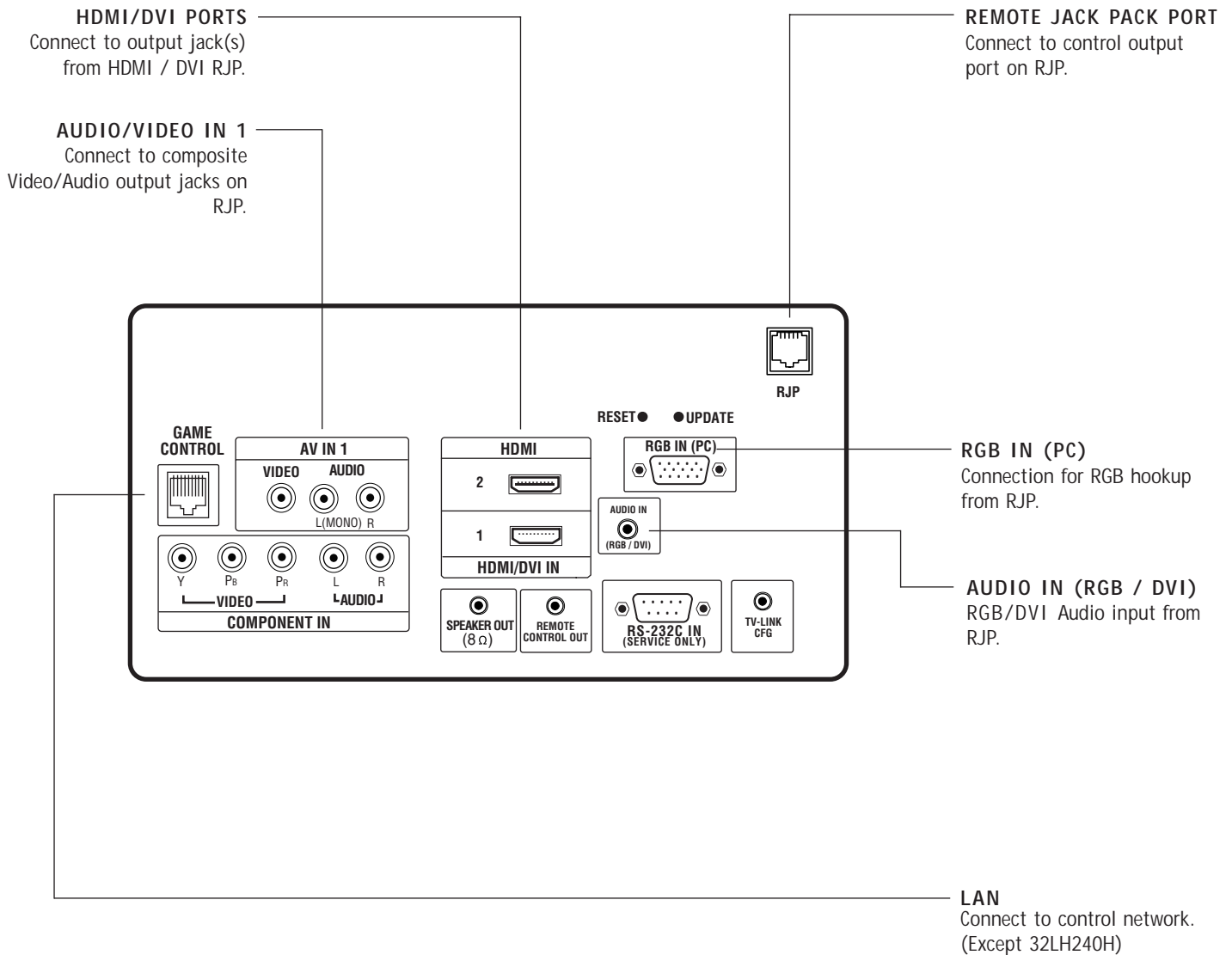

The MPI card is equipped with an RF jack for antenna/cable signal source connection.  
The MPI card slot is also available for installing a PPV (Pay-Per-View) card.

### MPI Card Removal / PPV Card Installation

1. Remove the two MPI card retainer screws.
2. Pull out current MPI card far enough so that the RF cable can be detached from the old card.
2. Detach RF cable.
3. Place new PPV card into slot and slide it in far enough to reconnect RF cable.
4. Insert card all the way into the slot making sure it is fully seated into back plane connector.
5. Replace the two card retainer screws.

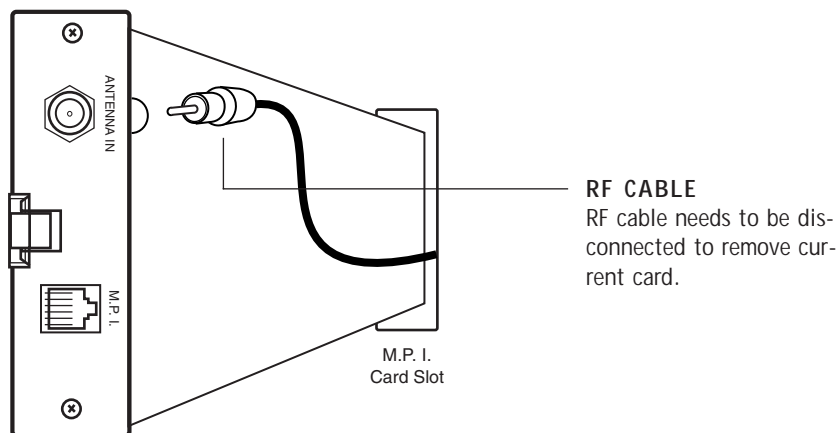



# TV Features Configuration Menus Overview

*The onscreen menus control the basic TV features*

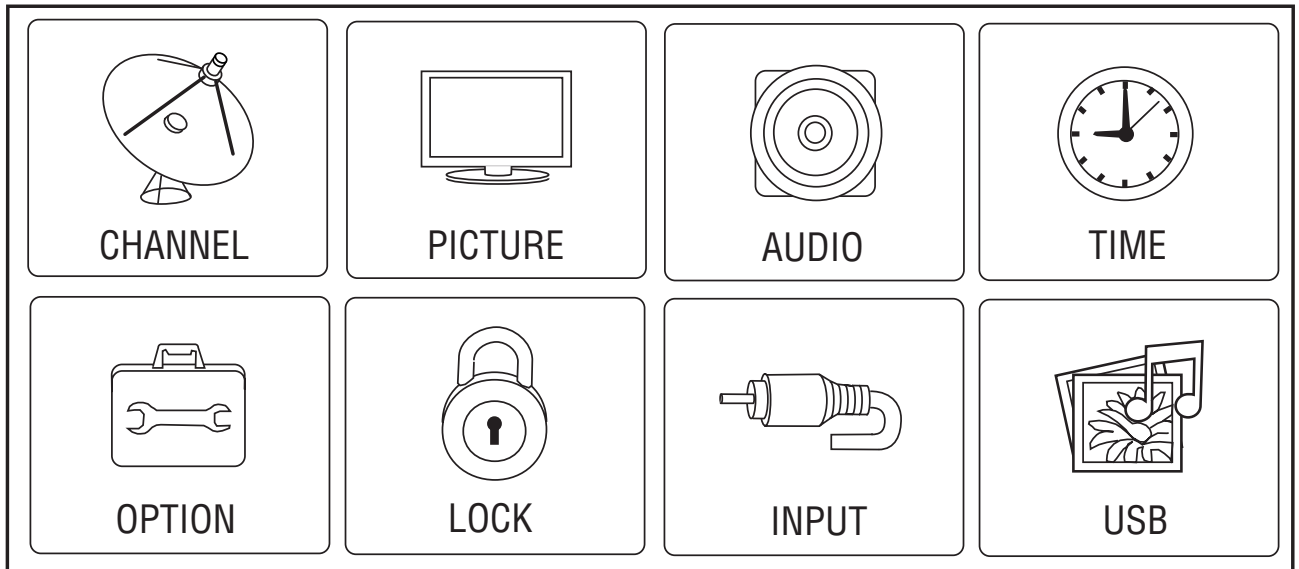

## Main TV Menus

The Main TV setup menus control the features of the TV. Set the TV features to the desired configuration for the end user.

Use the USB port to upgrade TV software.

## Connections for the TLL-1100A Clone Programmer to Learn the TV Master TV Setup

### On Master TV

Set up all Master TV features on the menus and do a Channel Search. Add Channel and Aux labels etc. See previous page. Insert MPI cable into TV MPI port.

### On TLL-1100A

1. Turn On the TLL-1100A.
2. Use the Mode button to select Clone Mode.
3. Use the Left/Right arrow to select the CBank (1 - 8) to store the master setup in.
4. Plug the other end of the MPI cable into the MPI port on the bottom of the TLL.
5. With the Installer remote control, select item 1 on TLL menu.
6. Press Enter, to transfer the Master setup into CBankX on the TLL. The TLL will copy the master setup.
7. When learning is done, disconnect MPI cable from Master TV.
8. Reconnect TV power cord. Power the TV On and the master setup should be resident on the TV.

### On Target TV

1. Connect MPI cable from the TLL to the MPI port on the Target TV. Assure that the correct CBank(X) is selected on TLL..
2. With the Installer remote control select item 2, to Teach the target TV the master TV setup.
3. Press Enter to begin teaching.
4. When Teaching is done, disconnect MPI cable and power the TV Off. Unplug TV power cord.
5. Reconnect TV power cord. Power the TV On and the master setup should be resident on the TV.

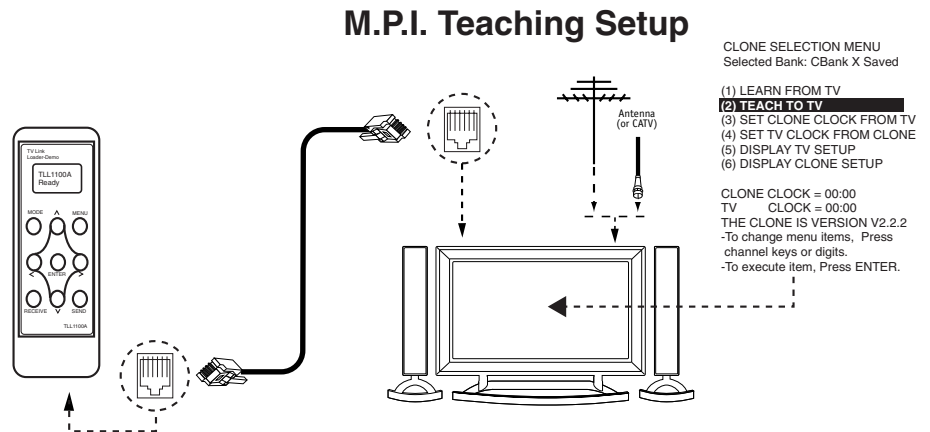
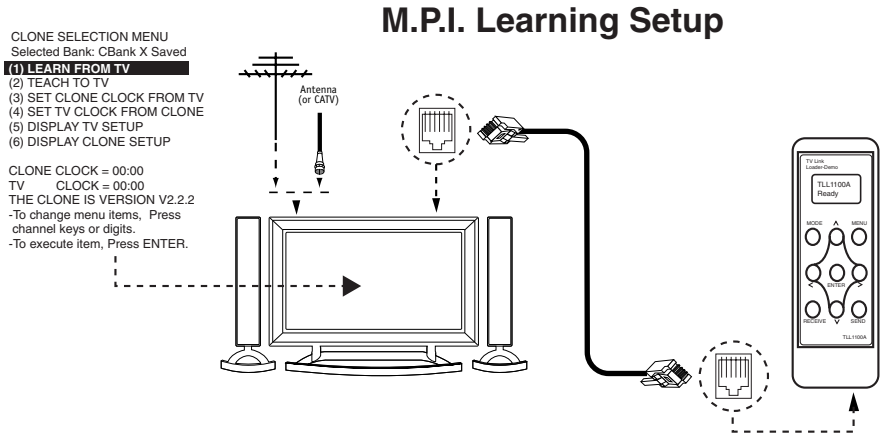

**Warning:** Do not use the TLL-1100A while any PPV card is installed in TV or clone programmer device will be damaged.

**Notes:** It is assumed that the TV is connected to a signal source, the TV source selected is Antenna (RF) In, the signal is from an Analog channel, not a digital channel, all equipment is connected to power and turned on and the TLL Cloner main menu is displayed on the TV screen, see above.

► If an analog channel is not available, tune TV to an Aux source like AV-1 for cloning purposes.

# LT2002 Cloning Connections/Learning Setup

## Connections for the LT2002 Clone Programmer to Learn the TV Master TV Setup

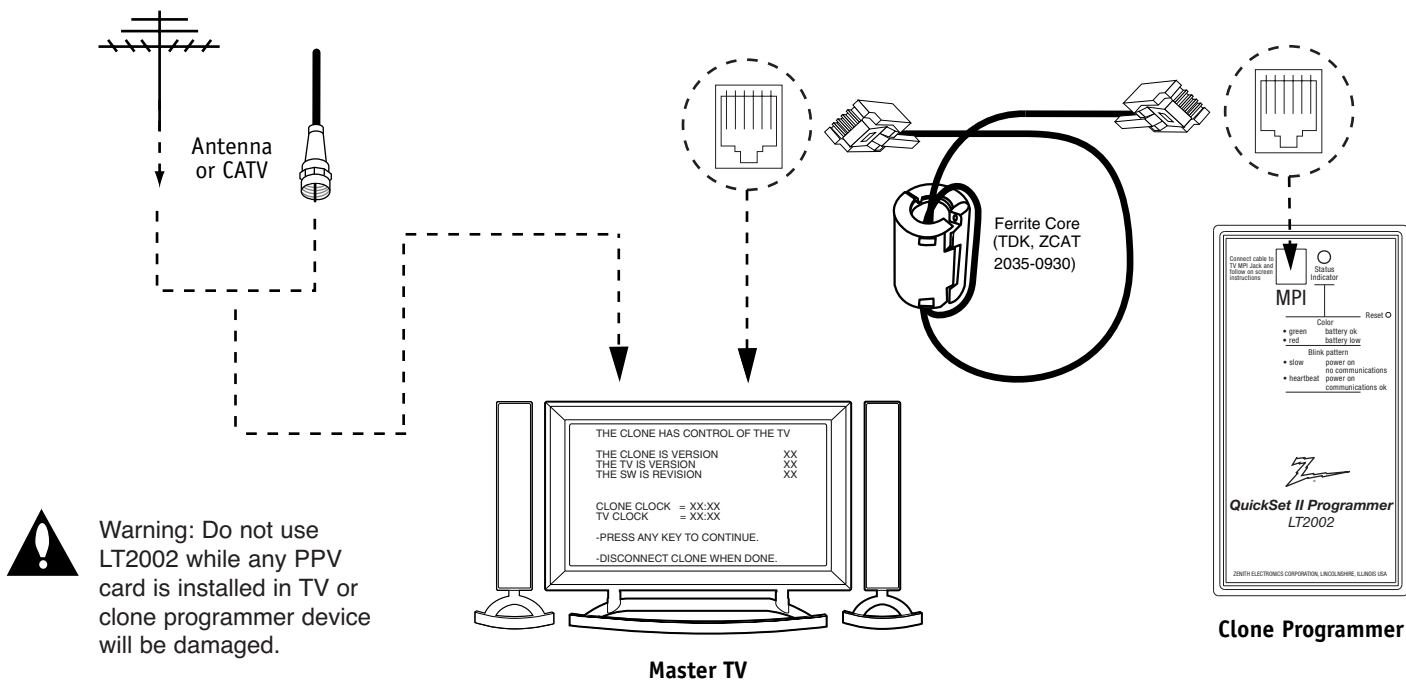

**Notes:** It is assumed that the TV is connected to a signal source, the source selected is Antenna (RF) In, the signal is from an Analog channel, not a digital channel, all equipment is connected to power and turned on and the LT2002 Clone Programmer main menu (THE CLONE HAS CONTROL OF THE TV) menu is displayed on the TV screen, see above and next page.

► If an analog channel is not available, tune TV to an Aux source like AV-1 for cloning purposes.

### Before you begin cloning...

- The Master TV should be connected to a good, stable signal from an over-the-air antenna or cable service Analog channel and connected to power. (See above.)
- Teaching and Learning is only possible between identical model devices. (However, the LT2002 Clone programmer can store up to 3 different 'master' setups.)

**WARNING:** Copying a blank or incorrect memory into a TV, STB or other device will cause the TV, STB or other device to operate erratically or become inoperable.

- Use an Installer's remote to operate Learning and Teaching menus.
- Make sure that the batteries in the Clone programmer are fresh.

- If batteries are removed, the Clone Clock time will be lost.
- Decide if you want to set the time from the Clone programmer or copy the time to the Clone programmer; from a compatible TV which has the clock set to the current time.
- Setting the time and transferring it to the Clone or other device is a separate procedure.
- Follow the connection diagram above to connect the Clone to a Master TV TV display panel. After learning is complete, to another identical TV TV display panel to "teach" it the master setup.
- See the Clone Troubleshooting section to resolve problems.

Turn to the next page to continue Cloning Setup.

## Learning the Master TV Setup

### Instructions for the Clone Programmer to Learn the Master TV Setup

#### Use MPI Cable to Connect LT2002 Clone Programmer to Master TV MPI Port

If there is a good connection, "THE CLONE HAS CONTROL OF TV" message will appear. Press any key on the Installer remote.

#### Learn Setup from Master TV

Press 1 to select the "LEARN FROM TV" option, then press ON/OFF, POWER, or ENTER to go to the Memory Bank Selection Menu. Pick the Memory "Bank" you want to store the master TV's setup in by pressing either Channel key repeatedly to choose Memory 1, 2 or 3. (If you choose a Memory "Bank" that has a master device's setup programmed into it, that setup will be overwritten by the new master TV's setup.) Once the Clone memory bank is selected, press ON/OFF, POWER, or ENTER. The Clone memory bank you have selected will be shown. Press ON/OFF or POWER to begin copying the master TV's setup.

#### Set the Clock (Optional)

Set the time on a Master TV's Clock. (If the time has already been copied from a TV into the Clone programmer, you can set a master TV's clock by copying the time from the Clone programmer.) The Clone Programmer can copy the current time to both a master TV and to the Clone's internal clock; accurate to within one minute. (Another reason that the Clone programmer should be equipped with fresh, high-quality alkaline batteries, is for it to keep the time as accurately as possible.)

Since the Clone Programmer's time cannot be set directly, the current time needs to be copied from a Zenith/LG TV equipped with M.P.I. input capability.

After the time is copied to the Clone programmer, the current time can then be transferred to another TV. (This can be a master TV, or another TV which has already had the features set up.)

```

THE CLONE HAS CONTROL OF THE TV

THE CLONE IS VERSION      XX
THE TV IS VERSION        XX
THE SW IS REVISION       XX

CLONE CLOCK=             XX:XX
TV   CLOCK=              XX:XX

-PRESS ANY KEY TO CONTINUE.

-DISCONNECT CLONE WHEN DONE.
    
```

This menu should appear by itself after the LT2002 is connected to the TV MPI port.

```

CLONE SELECTION MENU

(1) LEARN FROM TV
(2) TEACH TO TV
(3) SET CLONE CLOCK FROM TV
(4) SET TV CLOCK FROM CLONE
(5) DISPLAY TV SETUP
(6) DISPLAY CLONE SETUP

-TO CHANGE MENU ITEMS, PRESS
CHANNEL KEYS OR DIGITS.
-TO EXECUTE ITEM, PRESS ON/OFF,
POWER, OR ENTER
    
```

This menu should appear after any key is pressed on the Installer remote.

#### LT2002 Clone Programmer Communication Problems

- A slow flashing green light indicates there are communication problems between the TV and the LT2002 clone programmer. If this is the case, check for a damaged cable, poor contacts, or other connection troubles.
- If the status indicator is red, the programmer batteries are low and should be replaced. Install 4 high-quality alkaline AA batteries.

# Cloning Connections/Teaching Setup

## Teaching the Master Setup to Another TV

### Connections for the LT2002 to Teach another TV the Master Setup

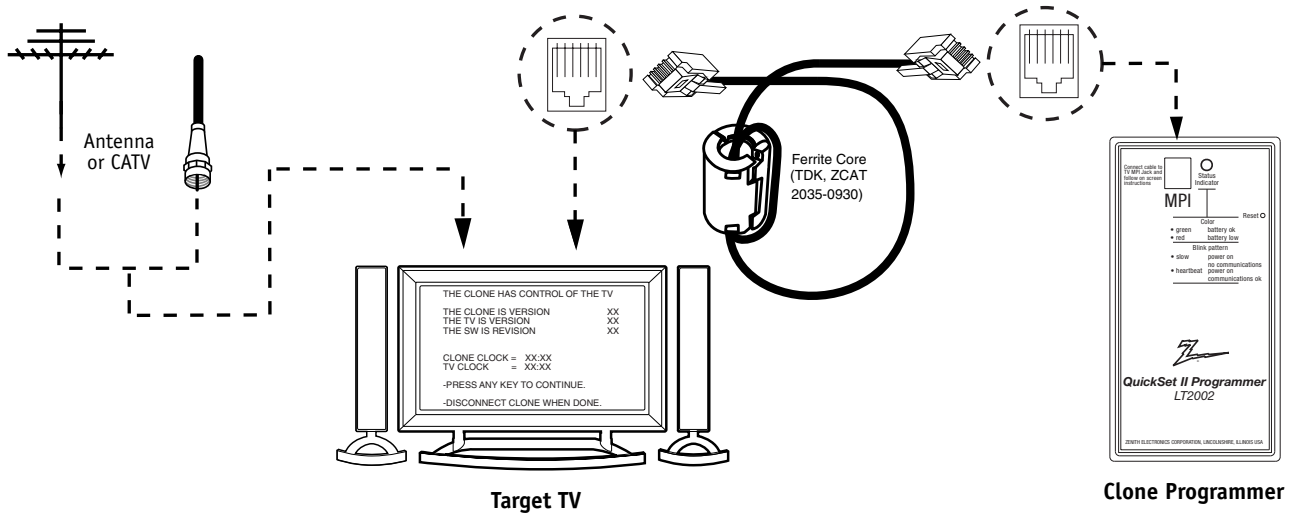

► If an analog channel is not available, tune TV to an Aux source lik AV-1 for cloning purposes.

### Teach Master TV's Setup to the target TV

After learning is complete, remove the M.P.I. cable from the master TV and connect it to the target TV that you want to copy the master TV's setup into. With "THE CLONE HAS CONTROL OF TV" message displayed, press 2 or use either Channel key to go to the "TEACH TO TV" option, press ON/OFF, POWER, or ENTER. Select the LT2002 memory that the new setup is in. Press On/Off to transfer the new setup and other information to the new TV. Teaching usually takes 2-3 minutes. After the "TEACHING COMPLETE" message is displayed, press any key to return to the Clone menu, then press ON/OFF, POWER, or ENTER. If finished, detach M.P.I. cable from the target, newly-cloned TV.

### Disconnect TV Power for 15 Seconds

Unplug the AC power cord of the newly-cloned TV from the power outlet for about 15 seconds to activate the newly-copied setup.

CLONE SELECTION MENU  
(1) LEARN FROM TV  
(2) TEACH TO TV  
(3) SET CLONE CLOCK FROM TV  
(4) SET TV CLOCK FROM CLONE  
(5) DISPLAY TV SETUP  
(6) DISPLAY CLONE SETUP

-TO CHANGE MENU ITEMS, PRESS CHANNEL KEYS OR DIGITS.  
-TO EXECUTE ITEM, PRESS ON/OFF, POWER, OR ENTER

This menu should appear after any key is pressed on the Installer remote.

TEACHING IN PROGRESS,  
PLEASE WAIT

This display will appear during Teaching function.

TEACHING COMPLETE

This display will appear after Teaching is complete.



**Warning:** Do not use LT2002 while any PPV card is installed in TV or clone programmer will be damaged.

### Note

The LT2002 programmer is designed to be used with TVs containing the 221-01006 and later processors. Use with earlier TV sets may give unpredictable results. Processors used before the 221-01006-04 have a limited screen display capability. They cannot display entire screens as shown in the quick setup instructions accompanying the LT2002 clone programmer. Use the printed menu illustrations on the quick setup sheet supplied with the Clone as an aid to making your programming choices. (Although the menus are not all displayed, the clone functions all operate normally.)

### Reset Clone After Static Shock

After replacing exhausted batteries, or if the programmer behaves strangely after a static shock, use a paper clip or similar instrument inserted through the small hole marked "RESET" to activate the internal reset switch and restore normal operation. After a reset, check the real-time clock setting. It may be necessary to reset the Clone Programmer clock from a TV containing the correct time.

## Clone Programmer Troubleshooting

Problem	Possible Cause(s)	Possible Solution(s)
<b>Clone Programmer</b>		
Clone copies Setup in less than 30 seconds	<ul style="list-style-type: none"> <li>• Not enough time to copy entire TV setup.</li> </ul>	<ul style="list-style-type: none"> <li>- Press Reset on clone programmer, redo teach/learn. (Teach/Learn should take a minimum of 1 minute.)</li> </ul>
Remote does not operate clone.	<ul style="list-style-type: none"> <li>• Wrong Installer remote.</li> </ul>	<ul style="list-style-type: none"> <li>- Only use an LG Installer remote to operate clone programmer with TV.</li> </ul>
LED does not blink.	<ul style="list-style-type: none"> <li>• M.P.I. cord not connected.</li> <li>• TV not turned on.</li> <li>• Weak batteries.</li> </ul>	<ul style="list-style-type: none"> <li>- Connect M.P.I. cord properly, assure good connection.</li> <li>- TV must be powered On for clone to work.</li> <li>- Install 4 fresh AA high-quality alkaline batteries.</li> </ul>
Clone menu hard to read.	<ul style="list-style-type: none"> <li>• Weak signal.</li> </ul>	<ul style="list-style-type: none"> <li>- Connect TV to a reliable Analog channel signal source.</li> </ul>
No time set.	<ul style="list-style-type: none"> <li>• Time not available.</li> </ul>	<ul style="list-style-type: none"> <li>- Set time on a TV, copy time to Clone Programmer.</li> </ul>
Clone not working.	<ul style="list-style-type: none"> <li>• Clone programmer problem.</li> </ul>	<ul style="list-style-type: none"> <li>- Try a different LT2002 Clone programmer.</li> <li>- Reset Clone Programmer.</li> </ul>
Clone Scans Channels more than once.	<ul style="list-style-type: none"> <li>• Clone should only scan channels once.</li> </ul>	<ul style="list-style-type: none"> <li>- Retry cloning again.</li> </ul>

### Master and Other TVs

Cloning did not work.	<ul style="list-style-type: none"> <li>• Procedure interrupted.</li> <li>• Different TV models.</li> <li>• Step(s) omitted or not performed.</li> </ul>	<ul style="list-style-type: none"> <li>- Wait until procedure complete message is displayed.</li> <li>- Cloning is only possible with identical model TVs.</li> <li>- Reread pages 7-8-9 to be sure all tasks were performed.</li> </ul>
Clone time disappeared.	<ul style="list-style-type: none"> <li>• Batteries were removed.</li> </ul>	<ul style="list-style-type: none"> <li>- Batteries must remain installed to retain time settings.</li> </ul>
New Setup not present.	<ul style="list-style-type: none"> <li>• TV not reset.</li> </ul>	<ul style="list-style-type: none"> <li>- Disconnect newly-cloned unit from power for 5 seconds.</li> </ul>

- After cloning operations are complete, just unplug the LT2002 from the TV.
- If the TV does not display a picture on the TV (blank screen) after a few seconds, just change channels.

# Installer Menu

Use the Installer's Menu to set up or change operational settings.  
See more detailed descriptions of the Installer menu items on the following pages...

## Accessing the Installer's Menu

Make sure TV is on. Installer's menu items can be accessed by using an installer's remote control. Just press MENU repeatedly until the TV seems to stop responding, then press 9, 8, 7, 6, then ENTER to access the Installer's menu. To remove the Installer's menu, press ENTER again. *Any changes you make will be stored in nonvolatile memory.*

The Installer's menu opens with item 000 INSTALLER SEQ 000. Use the Up/Down arrow keys to sequence through the available menu items. Or, access an item directly by keying in the line number, then pressing MENU. For example, to access the Sleep Timer option which is item 015, press 0-1-5, then MENU. To change a setting, use the Left/Right arrow keys. Or, enter a value directly.

## Using the Installer's Menu

Items 000 ~ 118 are immediately accessible only upon entering the Installer's Menu. Their numbers, descriptions, ranges, factory default settings, and a place for listing any changes made on-site are given below and on the following pages. Installer menu items not relevant to this TV series are not present on the Installer menu, therefore some numbers are missing. Items 006, 012, 013 etc., will not appear.

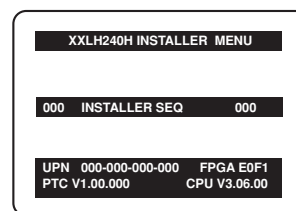

For 32LH240H

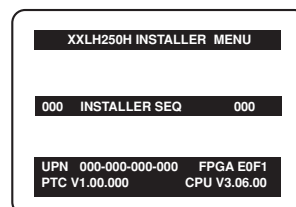

For 32/37/42LH250H,  
32/37/42LH255H

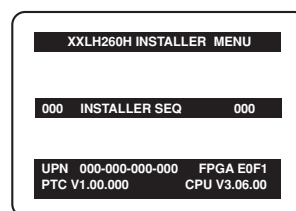

For 37/42LH260H  
37LH265H

Typical Installer Menu

## Installer Menu Items 000 through 034

Menu Item	Function	Value Range	Default Value	Brief Description of Function and Comments
000	INSTALLER SEQ	0 ~ 3	0	Leave default set to 0.
001	POWER MANAGE	0 ~ 7	0	Sets number of hours of no activity before auto shut Off.
002	AC ON	0 / 1	0	Set to 1 to enable auto turn On at power up.
003	BAND/AFC	0 ~ 3	1	Selects Tuning Band: 0=Broadcast, 1=CATV, 2=HRC, 3=IRC
004	STRT CHANNEL	0 ~ 127, 255	255	Channel at turn-on (Set to 255 to tune in last channel before power Off).
005	CHAN LOCK	0 / 1	0	If set to 1, cannot tune from current channel.
007	STRT VOLUME	0 ~ 63, 255	255	Sets Volume level at TV turn-on (Set 255 to retain last volume level).
008	MIN VOLUME	0 ~ 63	0	Sets minimum allowable volume setting.
009	MAX VOLUME	0 ~ 63	63	Sets maximum allowable volume setting.
010	MUTE DISABLE	0 / 1	0	Set to 1 to disable mute function.
011	KEY DEFEAT	0 / 1	0	Set to 1 to disable menu navigation keys on display panel.
015	SLEEP TIMER	0 / 1	1	Set to 1 to enable Sleep Timer.
016	EN TIMER	0 / 1	0	Set to 1 to enable On/Off Timers.
017	ALARM	0 / 1	1	Set to 1 to enable Alarm.
021	V-CHIP	0 / 1	1	Set to 1 to enable V-Chip functions.
022	MAX BLK HRS	0 ~ 99	12	Sets number of V-Chip (Parental Control) blocking hours.
023	CAPTION LOCK	0 / 1	0	Set to 1 to retain caption setting at power Off.
028	CH. OVERRIDE	0 / 1	1	If set to 0, limits direct access to favorite channels.
029	OLD OCV	0 / 1	0	Set to 1 to change M.P.I. operation to OCV.
030	ACK MASK	0 / 1	0	If set to 1, changes M.P.I. for some OCV boxes.
031	POLL RATE	20 ~ 169	94	Selects poll rate for M.P.I.
032	TIMING PULSE	186 ~ 227	207	Sets baud rate for M.P.I.
034	CAMPOR EN	0 / 1	1	Set to 1 to enable Video 2 input.

Installer Menu Items 035 through 118

Menu Item	Function	Value Range	Default Value	Brief Description of Function and Comments
035	COMPPORT EN.	0 / 1	1	Set to 0 to disable HDMI 1. Set to 1 enable HDMI 1
038	YPrPb EN.	0 / 1	1	Set to 1 to enable display panel Component Video 1 input jacks.
039	REAR AUX EN	0 / 1	1	Set to 1 to enable display panel Video 1 input jack.
040	AUTO CAMPORT	0 / 1	1	Set to 1 to automatically switch to Camport. If set to 1, STRT AUX SRCE cannot be set to 2.
046	STRT AUX SRCE	1 ~ 6, 255	6	Sets the starting AUX source.
047	AUX STATUS	0 / 1	0	Set to 1 for M.P.I. AUX source to be reported as a channel number instead of Channel 0.
053	DIS. CH-TIME	0 / 1	0	Set to 1 to disable Channel-Time display.
069	EN. CH-T COL.	0 / 1	1	Set to 1 to enable custom color for the Channel-Time display.
070	FOR. CH-TIME	0 ~ 7	2	Chooses custom foreground color for the Channel-Time display.
071	BCK. CH-TIME	0 ~ 7	2	Chooses custom background color for the Channel-Time display.
073	CH NOT AVBLE	0 / 1	0	If set to 1 and channel override is 0, "NOT AVAILABLE" message is displayed when directly accessing a channel not in the favorite channel list.
075	REVERT CH	0 / 1	0	If set to 1 and loss of M.P.I. communication occurs, TV tunes to Start Channel.
078	UPN MSB	0 ~ 255	0	User programmable number, most significant byte.
079	UPN MSB-1	0 ~ 255	0	User programmable number, most significant byte - 1.
080	UPN MSB-2	0 ~ 255	0	User programmable number, most significant byte - 2.
081	UPN LSB	0 ~ 255	0	User programmable number, least significant byte.
082	CHKSM ERROR	0 / 1	1	Enforces rigid M.P.I. checksum.
083	HANDSHK TIME	0 ~ 5	5	Relaxes M.P.I. timing to be compatible with PC based Windows-controlled systems.
084	PERMANENT BLK	0 / 1	0	Removes block hours setting for Parental Control and makes block permanent.
087	REAR RGB EN.	0 / 2 / 18	2	Set to 0 to disable RGB1. Set to 2 to enable for PC and Auto Configure always enabled. Set to 18 to enable for PC and Auto Configure one time only after AC ON.
088	EN NOISE MUTE	0 / 1	1	If set to 1, mutes audio if no signal is present.
090	KEY LOCK	0 / 1	0	If set to 1, keyboard is locked out, IR is still functional.
091	YPrPB2 EN	0 / 1	1	Set to 1 to enable HDMI-2 input.
093	RJP AVAILABLE	0 1 2 5 6	0	Set to 0 to disable. Set to 1, 2, 5 or 6 for HDMI or DVI mode. (See detailed descriptions.)
094	SAP MENU EN	0 / 1	1	Set to 0 to disable feature on Function menu. Set to 1 to enable feature on Function menu.
096	DEF. ASP. RATIO	0 ~ 4	2	Sets default aspect ratio at power up. See detailed descriptions and item 106.
099	BACK LIGHTING	1 ~ 100 101 ~ 200, 255	200	Sets the brilliance of the TV picture backlighting. Settings above 101 control dynamic back lighting and disable power saving mode..
102	ATSC BAND	0 ~ 4	4	Selects ATSC band.
103	ATSC TUNE MODE	0 / 1	1	Default 01 for physical channel scan. Set to 0 for Virtual Channel scan.
104	START MINOR CH	0 ~ 255	0	Selects Minor start channel. Set 0 for NTSC. Not 0, sets Minor channel number.
106	ASP RATIO LOCK	0 / 1	0	To retain set aspect ratio on power cycle, set to 1. Set to 0 for default ratio on power cycle.
116	VIDEO MUTE EN	0 / 1	0	Set to 0 for normal, set to 1 for Blank.
117	FACT DEFAULT	0 / 1	0	0=Normal. 1=Loads presets of all above settings.
118	POWER SAVING	1, 3, 7	3	Set to 1 to be powered at b-Lan module. Set to 3 to be powered at b-Lan module only when TV is powered n. Set to 7 to be not powered at b-Lan module.

(Except 32LH240H)

Note 1: Dependent on item 093 RJP Available setting.



# Installer Menu

## Detailed Descriptions of Installer Menu Items

### 000 - INSTALLER SEQUENCE

Specifies entry sequence to the Installer Menu.

0 = 9876	1 = 4321
2 = 1478	3 = 3698

### 001 - POWER MANAGE (Power Management)

Determines hours of no activity before automatic shutoff. The POWER MANAGE function is for saving energy. If set to 0, Power Manage is Off. Settings range from 0 ~ 7, with 1 ~ 7 representing the hours that the unit will remain On, unless there has been activity from either the control panel or remote control.

### 002 - AC ON (AC Power Switchable)

If set to 1, allows the TV to turn On just by applying AC power. Pressing the On button is not necessary. This is desirable if the TV is plugged into a cable box or a power outlet controlled by a wall switch. Use ADJ Left/Right arrow to choose 0 or 1 where 0 is the default is Off, and 1 is On.

**NOTE:** If set to 1 (On), the TV does not respond to On/Off commands from either the remote or the display control panel, and the SLEEP TIMER is also nonfunctional.

### 003 - BAND/AFC (Band/Automatic Frequency Control)

There are 4 possible settings for this option:

0 = Broadcast	1 = CATV
2 = HRC	3 = IRC

If some channels were not found by Auto Tuning (Channel Search), select the appropriate Band setting here and add the channels using the Channel Edit option in the Channel Menu.

### 004 - STRT CHANNEL (Start Channel)

If active, this function allows you to determine the initial channel number when the TV is turned On. This feature is useful for an in-house information channel, since the TV would always select that channel when it is turned On. Setting this to 255 causes the last channel viewed when the TV was turned Off, to be the tuned to channel when the TV is turned On again. Note: For a digital Start Channel, always remember to set item 104 to the Minor Start Channel number.

255 = Last channel	1 ~ 125 = Ch X	0 = Aux
126 Map to Channel 3.	127 Map to Channel 4.	

### 005 - CHAN LOCK (Channel Lock)

CHAN LOCK is ideal if the system must always be on the same channel. Changing channels with Channel Up/Down or keypad numbers is impossible. Channel Lock is inactive if set to 0 (default).

Generally, this feature is used in connection with START CHANNEL (Installer item 004) where the start channel may, for example, be set to 3 or 4. If the start channel is 3, then the TV will remain locked on Channel 3.

#### **NOTE: For Items 007, 008 and 009**

For legacy reasons, the scale used is 0 - 63. The PTC software will translate this to the 0 - 100 scale used by the TV.

To translate a TV volume level to the installer menu value, use the following formula:

$$\text{Installer Value} = \frac{\text{TV Value} \times 63}{100}$$

Enter only the whole number (disregard fractions).

### 007 - STRT VOLUME (Start Volume)

This function allows the Installer to determine the initial volume level setting when the TV is turned On. This feature is useful for an in-house information channel, since the TV would always select that volume level when it is turned On. The range of values are 0 - 63, 255. If 255 is selected, the current volume level will be retained in memory when the TV is turned Off; at turn On, the volume level will be automatically set at the previous or last level.

### 008 - MIN VOLUME (Minimum Volume)

This function determines the minimum volume level allowable with the VOLUME (VOL) Up/Down control. In this way, for example, someone cannot set the volume too low to hear. The value range is from 0 to 63 — change values with ADJ Left/Right arrow. The factory default is 0, which provides the full range of volume control, if item 009 MAX VOLUME is also set to 63. It may be best to set the same value on every TV.

**NOTE:** The minimum volume level cannot have a value setting higher than the MAX VOLUME level (described below).

### 009 - MAX VOLUME (Maximum Volume)

This function determines the maximum volume level allowable with the VOLUME (VOL) Up/Down controls. In this way, for example, someone can not set the volume level high enough to disturb others. The value range is 0 to 63, with 63 as the default, which gives the user the full range of volume control, if item 008 MIN VOLUME is also set at 0. Change values with ADJ Left/Right arrow keys. It may be best to set the same value on every TV.

**NOTE:** The maximum volume level cannot have a value setting lower than the MIN VOLUME level (described previously).

### 010 - MUTE DISABLE

Enables or disables sound mute function. If set to 1, sound cannot be muted. If set to 0, sound can be muted.

## 011 - KEY DEFEAT (Keyboard Defeat)

If set to 1, key defeat prevents the end user from accessing the on-screen menus with the display front panel—MENU, SELECT, and Left / Right arrow keys do not function. If set to 0, those keys do function.

**NOTE:** The menus can always be accessed by pressing MENU on the remote.

## 015 - SLEEP TIMER

If set to 1, the SLEEP TIMER feature may be used. If set to 0, the Sleep Timer is not available.

## 016 - EN TIMER (Enable On/Off Timers) \*

If set to 1, Timer function is available to user and enabled continuously. Set to 0 to disable On/Off Timers. (Clock must be set in order to use Timers.)

## 017 - ALARM \*

Gives the installer the option of making the Alarm function available to the end user. If set to 1, Alarm function is available to end user. Set to 0 to disable the Alarm function.

**NOTE:** Clock must be set before the Alarm function will work.

## 021 - V-CHIP (Parental Control) \*

Set to 1 to activate V-Chip (Parental Control); have it available to end user to filter and control or otherwise restrict programming content that can appear. Set to 0 to turn V-Chip feature Off, not available to user; no programming restrictions can be set.

## 022 - MAX BLK HRS (Maximum Block Hours) \*

Sets hours from 0 to 99 for the maximum V-Chip (Parental Control) block hours. Default setting is for 12 blocking hours.

## 023 - CAPTION LOCK

Set to 1 to restore previous caption On/Off state after turn Off. If set to 0, captions are always Off at turn On.

## 028 - CH. OVERRIDE (Channel Override)

If set to 1, the user can select channels with either Channel up/down or by direct keypad entry. If set to 0, only those channels that are entered for scanning can be selected.

## 029 - OLD OCV (On Command Video™)

Set to 1 for operation with systems from On Command Corporation.

## 030 - ACK MASK

M.P.I. Communication Parameter. Leave at default setting unless changed by Pay-Per-View provider. When set to 1, changes M.P.I. for some OCV boxes.

\* Only affects Function Menu if enabled by some PPV providers.

## 031 - POLL RATE

M.P.I. Communication Parameter. Selects Poll Rate for M.P.I. Leave at default setting unless changed by Pay-Per-View provider. Step size of 16 ms.

## 032 - TIMING PULSE

M.P.I. Communication Parameter. Leave at default setting unless changed by Pay-Per-View provider. Sets baud rate. Step size of 4.3 uS.

## 034 - CAMPORT EN. (Camera Port Enable)

Set to 1 to enable Video 2 input on display panel. If set to 0, Video 2 input on display panel is not functional.

**NOTE:** S-Video overrides Video jack.

## 035 - COMPPORT EN. (Computer Port Enable)

Enable/disables display panel HDMI1 input jack. Set to 0 to disable HDMI 1. set to 1 to enable HDMI 1.

**NOTE:** The setting above is ignored if Installer item 093 RJP AVAILABLE, is set to 1.

## 038 - YPrPb EN. (Rear Component Video Enable)

Set to 1 to enable display panel rear Component Video input jacks. Set to 0 to disable display panel rear Component Video input jacks.

## 039 - REAR AUX EN. (Rear Aux Enable)

Set to 1 to enable display panel rear AUX (Video 1) input. Set to 0 to disable display panel rear AUX (Video 1) input.

Note: S-Video overrides Video.

## 040 - AUTO CAMPORT

Set to 1 to automatically switch to Campport when equipment is connected to front Video input.

Set to 0 to disable front Video automatic source selection.

**NOTE:** If set to 1, 093 RJP Available is automatically set to 0.

## 046 - STRT AUX SRCE (Start Aux Source)

Sets the starting AUX source. At power up, TV will tune to starting Aux source if item 004 Start Channel is set to 0.

If item 093 RJP Available is set to 0 and item

040 Auto Campport is set to 0:

1 = Video 1	4 = RGB	255 = Last Aux
2 = Video 2	5 = HDMI 2	
3 = HDMI 1	6 = Component	

If item 093 RJP Available is set at 1:

2 = Video 2	5 = HDMI 2	6 = Component
-------------	------------	---------------

If item 040 Auto Campport is set to 1:

1 = Video 1	5 = HDMI 2
3 = HDMI 1	6 = Component
4 = RGB	

# Installer Menu

---

## Detailed Descriptions of Installer Menu Items

### 047 - AUX STATUS

Set to 1 for M.P.I. AUX source to be reported as a channel number instead of channel 0. Set to 0 to disable AUX identification change. Controls M.P.I. status channel response for AUX inputs.

### 053 - DIS. CH-TIME (Disable Channel-Time)

Set to 1 to disable the Channel-Time display, Channel-Time display will not appear.  
Set to 0 to enable the Channel-Time display.

### 069 - EN. CH-T COL. (Enable Channel-Time Custom Color)

Set to 1 to enable custom color for the Channel-Time display.  
Set to 0 to disable custom color for the Channel-Time display.

### 070 - FOR. CH-TIME (Channel-Time Display Foreground Color)

Set according to Color Chart.

0 = Black	3 = Cyan	6 = Yellow
1 = Blue	4 = Red	7 = White
2 = Green	5 = Violet	

**NOTE:** If foreground and background color are the same, menu background is transparent.

### 071 - BCK. CH-TIME (Channel-Time Display Background Color)

Set according to Color Chart.

0 = Black	3 = Yellow	6 = Cyan
1 = Red	4 = Blue	7 = White
2 = Green	5 = Violet	

**NOTE:** If foreground and background color are the same, menu background is transparent.

### 073 - CH NOT AVBLE (Channel Not Available)

If set to 1 and item 028 CHANNEL OVERRIDE is set to 0, "NOT AVAIL-ABLE" message is displayed when directly accessing a channel not in the channel scan list available in memory.

### 075 - REVERT CH (Revert to Start Channel)

If set to 1 and loss of M.P.I. communication occurs, TV automatically tunes to the specified Start Channel.

### 078 - UPN MSB (UPN Most Significant Byte)

User programmable number, most significant byte readable by M.P.I. command. Note: Not linked to serial number.

### 079 - UPN MSB-1 (UPN Most Significant Byte-1)

User programmable number, most significant byte-1 readable by M.P.I. command. Not linked to serial number.

### 080 - UPN MSB-2 (UPN Most Significant Byte-2)

User programmable number, most significant byte-2 readable by M.P.I. command. Not linked to serial number.

### 081 - UPN LSB (UPN Least Significant Byte)

User programmable number, least significant byte readable by M.P.I. command. Not linked to serial number.

### 082 - CHKSM ERROR (Checksum Error)

Enforces rigid M.P.I. checksum validation.

Set to 1 for validation.

Set to 0 to disable (does not check checksum on M.P.I. async port). SPI is always checked.

### 083 - HANDSHK TIME (Handshake Time)

Adds an additional delay to the handshake time which is 64 msec, thus relaxing M.P.I. timing requirements to be compatible with PC based Windows controlled systems, range is 0 - 5. (Timeout = 25.5MS + [25.5 MS\* Handshake time]).

### 084 - PERMANENT BLK (Permanent Block)

Allows Lock (Parental Control) blocking schemes to be permanent by disabling the blocking hours function.

Set to 1 to install Parental Control restrictions permanently.

Set to 0 for user-specified hours control of blocking schemes.

### 087 - REAR RGB EN. (Rear RGB Enable)

Controls access to rear RGB input on TV.

Set to 0 to disable RGB input.

Set to 2 to enable for PC and Auto Configure always enabled.

Set to 18 for Auto Configure one time only with power cord removal and reinsertion.

### 088 - EN NOISE MUTE (Enable Noise Mute)

If set to 1, audio mutes if no signal is present.

### 090 - KEY LOCK

If set to 1, display panel keyboard is locked out, not available to end user. IR receiver remains functional.

### 091 - YPrPb2 EN. (HDMI2 Enable)

Set to 0 to disable display panel HDMI2 input.

Set to 1 to enable DTV mode. Set to 2 to enable PC mode.

**093 -RJP AVAILABLE (Remote Jack Pack Available)**

0 = Remote jack pack is not available or disabled.

**1 = Legacy Model RJP: HDMI Mode**

Enables RJP when an HDMI cable is inserted into RJP. Video is from HDMI. Audio stream is expected from HDMI source. If no audio is present, no audio will be heard.

**2 = Legacy Model RJP: DVI Mode**

Enables RJP when an HDMI cable is inserted into RJP. Video is from HDMI however, Audio is from selected audio source, based on the RJP's audio hierarchical priority.

**5 = Scaler Model RJP: HDMI Mode**

Enables RJP when an HDMI cable is inserted into RJP. Video is from HDMI. Audio stream is expected from HDMI source. If no audio is present, no audio will be heard.

**6 = Scaler Model RJP: DVI Mode**

Enables RJP when an HDMI cable is inserted into RJP. Video is from HDMI however, Audio is from selected audio source, based on the RJP 's audio hierarchical priority.

Notes:

See Reference section, RJP Input Hierarchy and RJP Models page. If set to 1, 2, 5 or 6, item 040 Auto Camport is automatically set to 0. Settings 1, 2, 5 and 6 allow the lodge staff to customize each TV 's RJP setup based on customer requirements.

**094 - SAP MENU EN (2nd Audio Program)**

Set to 1 to enable SAP feature on Function menu, if Function menu is available.  
Set to 0 to disable SAP feature on Function menu, if Function menu is available.

**096 - DEF. ASP. RATIO (Default Aspect Ratio)**

Selects default aspect ratio at power up, see settings below.

Set to 0 for "Set By System".
Set to 1 for 4:3.
Set to 2 for 16:9 (Factory Default).
Set to 3 for 'Just Scan'
Set to 4 for Zoom

**099 - BACK LIGHTING**

Sets the TV screen brightness at power up, see settings below. Default setting is 200.

**1 - 100 Static Backlighting.**

(1 = Dimmest picture, 100 = Brightest picture.)

**101 - 200 Dynamic Backlighting.**

(101 = Dimmest picture, 200 = Brightest picture.) If settings are above

101, the TV automatically controls backlighting depending upon the picture level of the current program. set to 255, to disable power saving mode.

**102 - ATSC BAND**

Sets up TV to receive different types of incoming signals: 0=Broadcast, 1=CATV, 2=HRC, 3=IRC, 4=Same as NTSC.

**103 - ATSC TUNE MODE**

Sets ATSC tuning mode: Default set to 1 for Physical channel scan. Set to 0 for Virtual Channel scan.

**104 - START MINOR CHANNEL**

Sets XX-XX minor start channel number at power up: 0=NTSC. If not 0, number selected is the Minor start channel number.

**106 - ASP RATIO LOCK (Aspect Ratio Lock)**

Set to 1 to retain previous aspect ratio with power Off. Set to 0 to retain default aspect ratio with power Off. See item 96 Default Aspect Ratio above.

**116 - VIDEO MUTE EN (Video Mute Enable)**

Set to 0 for normal.  
Set to 1 for blank.

**117 - FACT DEFAULT (Factory Default)**

Set to 0 for normal.



Set to 1 to load presets to all of the previous item settings.  
**WARNING:** Setting this to 1 will reload the factory defaults and clear the channel list including erasing any assigned Channel Icons and custom channel Labels.

**118 - Power Saving (Except 32LH240H)**

Default is set to 3. When TV is in Standby mode, MPI card slot is powered by Standby power supply and embedded BLAN is not powered. When TV is in Power On mode, MPI card slot is powered by main 12V power supply and embedded BLAN is powered. Note, TV must be powered on in order to communicate with the embedded BLAN module for configuration and control.

- 1 = MPI card slot Standby mode power provided from Standby power supply and embedded BLAN is always powered on.
- 3 = MPI card slot Standby mode power provided from Standby power supply and embedded BLAN only powered on when TV is powered on.
- 7 = MPI card slot Standby mode power provided from Standby power supply and embedded BLAN always powered off.

## IMPORTANT INSTALLER SETUP INFORMATION! PLEASE READ THE FOLLOWING...



To set up a master TV you will need to know how to enter the TV Installer menu and make changes to the default values as required. If necessary, familiarize yourself with the TV Installer menu and how to make and save changes in the menu, before attempting to clone the TV Master TV setup.

You will also need an **LG Installer remote control** similar to the one shown in the front of this manual. The installer remote must have a "Source" button or its equivalent. The remote shown in this manual has a "INPUT" button -- this button serves the purpose of a Source button.

Finally, the TV's clonable features need to be set up. This is a critical step. If the Master TV display panel's clonable features

like adding channel icons or channel labels, digital font options etc., are not correctly added, then the cloned TVs will all have problems.

As the cloning procedure is being performed, specific steps need to be done at the indicated times to achieve the desired result. Be sure to do each task as indicated. If a procedure or step is left out or not performed completely, cloning may not work. At each step, pay attention to assure the TV screen shows the proper message when cloning. If the message indicated does not appear, there is a problem with that step and cloning may not be successful. Cloning is only possible when the signal source is an Analog channel, not a digital channel.

## Making a Master TV

### Detailed Instructions

The following describes the procedure for preparing a Master TV for cloning and the procedure for adding Channel Icons and/or Labels.

**Note 1:** Disconnect all Aux inputs. Under certain conditions, Auto Tuning Channel Search is disabled if there is an Aux input active.

**Note 2:** Under certain conditions, changes to the input mode of the RGB inputs will not take effect until the power is cycled (TV is turned Off and On). To avoid confusion, disconnect all RGB inputs before entering the Installer menu.

1. Enter the TV installer menu.
  - a. Reset the internal controller to factory default by accessing installer menu item 117 FACT DEFAULT, set it to 1 and press "ENTER". The value will change back to 0 after the TV's internal controller has been restored to factory default condition. This step will ensure that the TV channel memory will be the active channel list. Check the Status LED. If it is blinking rapidly then the TV channel map is in use.
  - b. Within the Installer menu, set the Installer menu items to the configuration required of your institution.
  - c. It is important to set the tuning band at this time, see Installer menu item 03 BAND/AFC.
  - d. Set Installer menu item 28 – CH OVERRIDE to 001 to allow access to the Auto Tuning and Ch. Edit features in the Channel Menu. Exit the Installer menu.
2. Access the Master TV menus and set the clonable options on the menus to the desired configuration. Refer to the

**Clonable Menu Features** Chart in this manual.

3. Run Auto Tuning to find analog and digital channels.
4. Enter the Channel Edit menu and edit the channel lineup to include the Free-To-Guest Channels only.
5. Assign ICONS to the channels using the Channel Label Menu.

**Note:** You can add Channel ICONS typically network logos like ABC, NBC, PBS etc. in this step. Or, in Step 7, add Channel ICONS or labels for channels without Icons.
6. Transfer the TV setup: Enter the TV installer menu. Press '2', '5', '5', 'MENU' to start the transfer of the TV's setup to the internal controller. Once the transfer is complete, the system will exit the Installer menu. Check the Status LED inside the TV. It should be blinking slowly (1 blink per second).
7. Edit/Add Channel ICONS and Channel Labels as needed. Enter Installer menu. With menu displayed, press 2-5-4 + MENU. See next page for detailed instructions:
  - **Editing/Adding Channel ICON and Labels on Master TV**
  - **Changing a Channel's ICON on Master TV**
  - **Changing/Adding Channel Labels on Master TV**
  - **Changing Source Labels on Master TV**
8. Verify Master TV setup and feature configuration:
  - Did you add Channel ICONS?
  - Did you add Channel Labels?
  - Did you add Source Labels?
  - Did you adjust all TV menu options as required?After verifying master setup, enter the TV Installer menu and set Installer menu item 28 CH OVERRIDE to 000. Press ENTER to remove and exit the Installer menu.

## Adding Channel Icons and Labels in the 2-5-4 + Menu Mode

### Editing/Adding Channel ICONs and/or Labels

If there is no pre-assigned ICON, you can make a custom channel label of up to 7 characters to help in identifying the channel or network. At your option, channel labels can also be added in addition to a pre-assigned ICON. You may also add labels for the Aux input sources to clearly identify the devices that are connected to the Aux inputs.

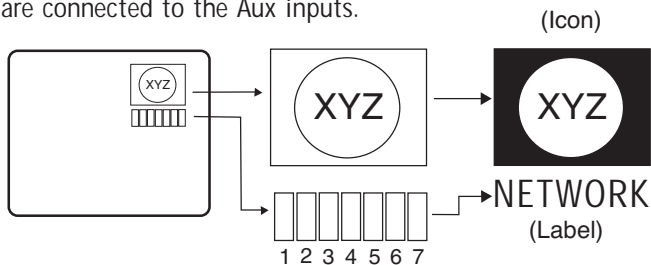

Editing and adding the labels can only be done if there are channels entered into the TV's channel map either by using the method described in item 6 (page 18), by cloning or by the use of the master remote control from the PPV provider.

Note: A blank letter space is available between 'Z' and '!'.

### To Do Channel Editing/Labeling, Proceed as Follows

1. Enter TV Installer menu.
2. Once the installer menu appears, press '2', '5', '4', 'MENU'. This enters the channel label editing mode. Add your channel icons and channel labels in this menu, see below. (You can do this more than once.)
3. To exit the menu when done press "MENU".

### Changing a Channel's ICON on Master TV

1. With Channel Up/Down, select the channel you want to change the Icon for.
2. With the Right or Left ADJ arrow, select the thin letter 'I' on the channel ID display.
3. With the Up or Down arrow, select the desired ICON you want to appear to identify the channel. (If you know the ICON number, enter the number followed by Enter / Select.)
4. Proceed with Changing/Adding Labels or go to the next channel.

### Changing/Adding Channel Labels on Master TV

1. Channel Up/Down to select the desired channel.
2. Press the Right or Left ADJ arrow repeatedly until the numbers 1 to 7 show up. The number shows the position of the character that can be changed. Number 1 is the first character, number 2 the second character and so on.
3. With the Up or Down arrow, select the desired character.
4. Proceed to the next number position or use Channel Up/Down to go to the next channel.

### Changing Source Labels on Master TV

1. Press "INPUT" to select the desired Aux input source; A/V 1, A/V 2, HDMI Component, RGB etc.
2. Press the Right or Left arrow repeatedly until the numbers 0 to 9 shows up. The number shows the position of the character that can be changed.
3. Use the Up or Down arrows to select the desired character.
4. Press "INPUT" for the next Aux source or proceed with Changing Icon or Changing/Adding Labels. Press Ch Up/Down to return to channels.

## Installer Remote Control Key Functions for Master TV Channel Editing/Labeling Menu

- **CHANNEL Up/Down** - Tunes in the next channel in scan.
- **Left/Right Arrows** - Select the item to change. If "I" is shown, the ICON can be changed. If a number is shown, it indicates the position of the character that can be changed.
- **Up/Down Arrows** - Select the ICON or the character to be displayed. Tip: Arrows can be held down for fast scrolling.
- **0 - 9** - Use to enter the index number of the ICON, if known.
- **ENTER/SELECT** - Changes the ICON after the number has been entered.
- **INPUT** - Changes the Aux input label. ("Source" on the remote shown in this manual is INPUT.)
- **MENU** - Exits the editing process.

# Reference: Clonable Menu Features

Clonable Menu Features		
<b>Menu /Sub Menu Features</b>		
<b>Installer Menu</b> Installer Item settings	<b>Audio</b> Contd. Treble Bass SRS TruSoundXT TV Speaker	<b>Lock</b> Movie Rating TV Rating – Children Age TV Rating – Children Fantasy Violence TV Rating – General Age Input Block
<b>Channel</b> Auto Tuning (Channel Lineup) Channel Edit Channel Label	<b>Option</b> Language Caption Caption Mode DTV Captions Style - Style DTV Captions Style - Size DTV Captions Style - Font DTV Captions Style - Text Color DTV Captions Style - Text Opacity DTV Captions Style - BG Color DTV Captions Style - BG Opacity DTV Captions Style - Edge Type DTV Captions Style - Edge Color	<b>Time</b> Auto Clock Manual Clock Off Time On Time Auto Off
<b>Picture</b> Aspect Ratio Picture Mode Advanced Control		
<b>Audio</b> Auto Volume Clear Voice Sound Mode Balance		

## Notes

- Picture Menu and other menu settings shown above are not clonable on all TVs.  
End user has access to Picture, Sound and Ratio on user remote control.
- Menu options vary between Analog / Digital channels and Aux Sources.

## Procedure for Checking Software Version

The software version of the TV may be checked by accessing the Installer Menu.

To do this, press MENU repeatedly until the menu display ceases to respond to MENU key presses.

Then, press "9", "8", "7", "6", "ENTER". Press ENTER again to remove Installer Menu from screen.

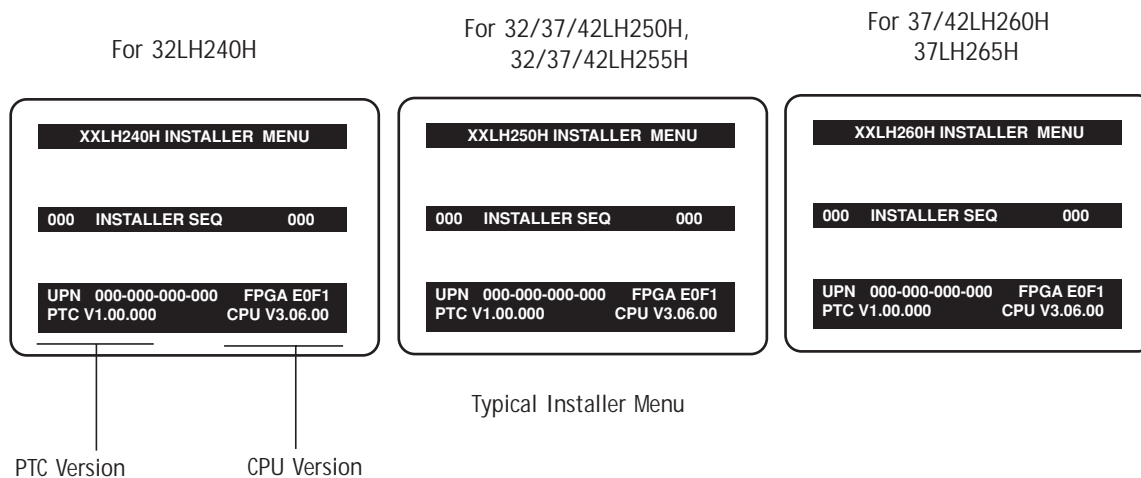

USB Menu features Picture Slideshow with or without Music accompaniment

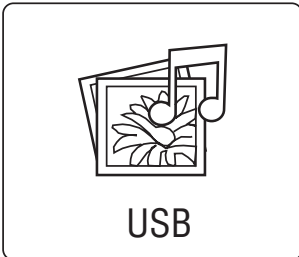

**USB Device Setup**

On the USB device, load Photo and Music files e.g. MP3. Insert USB device into USB port on TV side jack panel. Press Menu and select USB option, press Enter.

Note: Windows .wma files are not usable.

**View Pictures**

Select USB Icon and press Enter. Select Photo List option and press Enter. Select Folder photos are in. Press Enter. When photo list appears, choose Photo and press Enter.

**View Picture with Music**

Select USB Icon and press Enter. Select Music Folder option. Select Music List and select Play with Photo. Select music MP3 file and press Enter.

**Listen to Music MP3 Files**

Select USB Icon and press Enter. Select Music List option and press Enter. Select Folder with Music MP3 files. Press Enter. Adjust Volume to comfortable listening level.

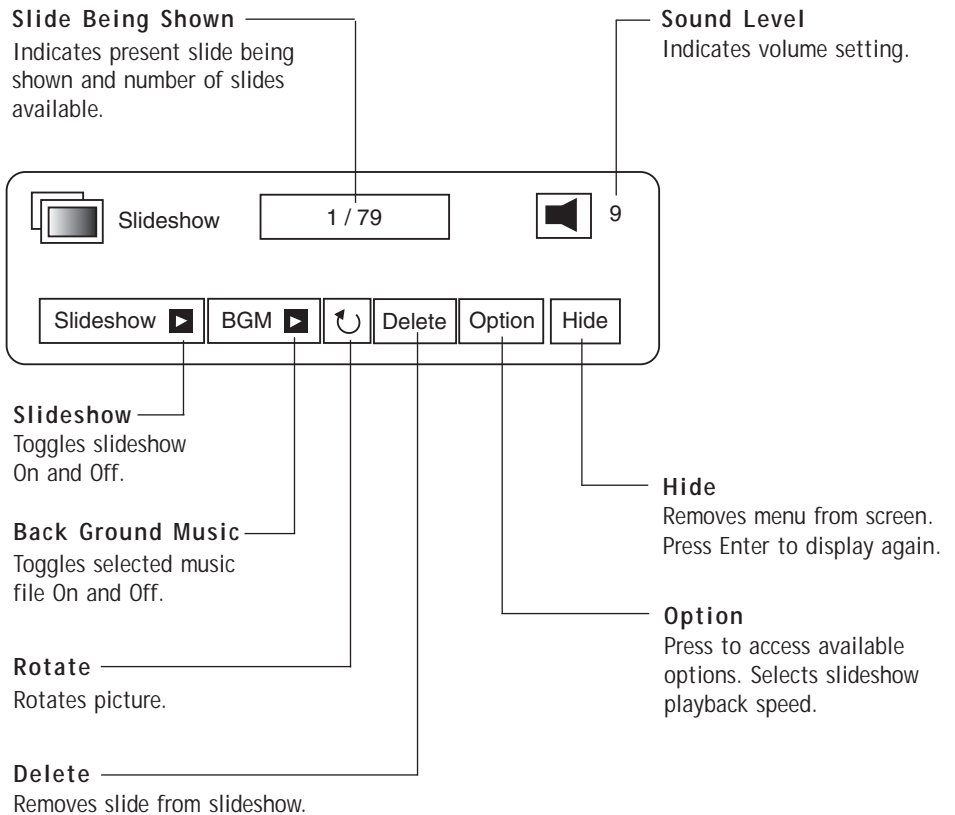



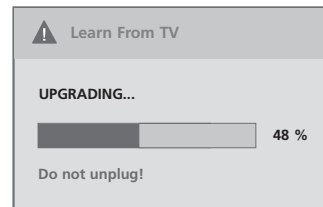
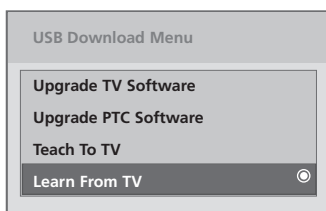

## On Master TV, Create Profile and Learn

1. Set up all Master TV features on the menus and do a Channel Search. Add Channel and Aux Labels etc. Do 255+ menu on Installer Menu to save current TV into flash memory.
2. Plug USB memory card into the USB In port on Master TV.
3. Press Menu key to open Main menu. Highlight the Option icon.
4. Press the Left arrow key once, the Option icon on left side of menu will be highlighted.
5. Press number key '7' a total of 7 times.
6. Access the "Learn From TV" option.
  - a. First, Expert Download Menu page will not show the "Learn From TV". In order to make "Learn From TV" available, key in the password which is used to enter Installer Menu. Example 9-8-7-6.
  - b. By pressing up/down arrow keys (if there is other menus), place the cursor on Learn From TV, then press Enter Key.
7. Using Up/Down arrow key, highlight "Learn From TV", then press Enter.
8. To identify the profile from others, you can change the last 5 digits. Key in a custom file name, then press the Enter key.
9. The Learning status will be shown on progress bar. As soon as learning the current profile is complete, a message will appear on screen indicating the learning process is done.
10. Remove the USB memory card.

## Optional: Edit / Change File Name

If necessary, the file name can be edited or changed.

For 32LH240H



For 32/37/42LH250H,  
32/37/42LH255H

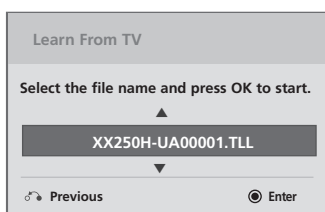

For 37/42LH260H  
37LH265H

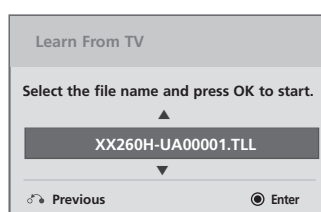

## Notes

- Do not remove TV power cord or USB memory card while Learning, doing so might harm your USB memory card.
- Do not remove TV power cord or USB memory card while Teaching, doing so may cause the TV to malfunction.
- You are allowed to edit the file name, however, a file with edited contents will not be recognized.
- Since clock data is copied into USB memory card as numeric data, the time difference between teaching and learning is not automatically adjusted. Either set the clock manually, or use Auto Clock set on TV main menu.



For 32LH240H



For 32/37/42LH250H,  
32/37/42LH255H

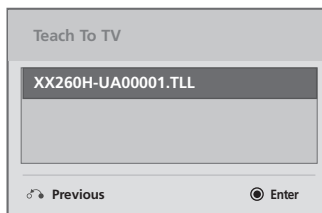

For 37/42LH260H  
37LH265H

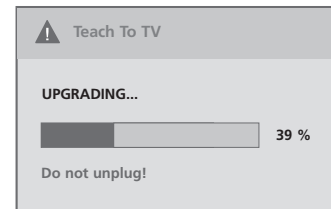

## On Target TV, Teach Master TV Profile

1. Plug USB memory card with Master TV Profile setup into Target TV USB input port.
2. Press Menu key to open Main menu and then highlight the Option Menu icon.
3. Press the Left arrow key once, this will highlight the Option icon on left side of menu.
4. Press number key '7', a total of 7 times.
5. Using the Up/Down arrow key, select 'Teach to TV', then press Enter key.
6. Use Up/Down arrow keys to navigate through profiles. Select the profile that you want to install by highlighting it and pressing the Enter key.
7. Teaching progress will be shown on the progress bar. As soon as teaching is done, a message will appear indicating that the teaching process has been completed.
8. When Teaching is done, remove the USB memory card and unplug TV power cord.
9. Reconnect TV power cord. Power the TV On and the master setup should be resident on the TV.

# TV Camport Auto Sense Operation

The CAMPORT Auto Sense function is enabled when:

1. Installer Menu Item 34, CAMPORT EN is set to 1 AND
2. Installer Menu Item 40, AUTO CAMPORT is enabled (1).

Selectable= Can be accessed with INPUT key, direct access, etc.  
 Auto Sense= Switches to this input when connector is inserted.  
 The camport (Side Video) has the highest priority and will override any commands including tuning to the Start Channel.

## CAMPORT (Front Video) Functionality Control

Item 34 CAMPORT EN	Item 40 AUTO CAMPORT	Front Video Operation
0	0	Disabled
0	1	Disabled
1	0	Selectable
1	1	Auto Sense

## CAMPORT Operation (Stand-Alone)

When Camport Auto Sense is enabled as above, the TV's source will switch to the side video aux source whenever a plug is inserted into any of the side video panel inputs (either composite Video or S-Video).

When the plug is removed, the TV will switch back to the previous channel or input source that the TV was using before the plug was inserted. However, if any direct access to an RF channel or Aux channel is requested while the camport is active, then, when the camport plug is removed, the TV will switch to the last requested channel. Source changes using any Source Keys (INPUT) are ignored. Channel Up/Channel Down and Flashback Commands are not direct access tuning commands and they are also ignored.

Previous State Before Inserting CAMPORT	Operation While CAMPORT Is Active	State Upon Removal Of CAMPORT
Aux or RF Channel	None	Previous Aux or RF Channel
Aux or RF Channel	Direct Access	Last Requested RF or Aux Channel
Aux or RF Channel	Ch Up/Down, Flashback and TV/AV Keys	Previous Aux or RF Channel

## CAMPORT Operation (PPV)

The operation will be similar to that of the Stand-Alone mode. However, the PPV providers may send different commands to the TV for the same user commands. For instance, some providers will always send a direct tune command when it receives a channel up/down or a flashback command while other PPV providers will just send a key command.

Previous State Before Inserting CAMPORT	Operation While CAMPORT Is Active	State Upon Removal Of CAMPORT
Aux or RF Channel	None	Previous Aux or RF Channel
Aux or RF Channel	Direct Access	Last Requested RF or Aux Channel
Aux or RF Channel	Ch Up/Down, Flashback and TV/AV Keys	Last Requested Channel if PPV translates it to direct access tuning command. Otherwise, goes to Previous Aux or RF Channel

DIRECT ACCESS Tuning		TV		ENABLE				MPI DATA			START AUX SOURCE ASSIGNMENT
				Installer Menu		MPI DATA STATUS TYPE 0x41 SOURCES ENABLED (R/W)		DATA STATUS TYPE 0xD2 CURRENT AV SOURCE (R)		DATA STATUS TYPE 0X0D AUX SOURCE (R)	
OLD_OCV=0	OLD_OCV=1	Source Input	Source Mode	Number	Labeling	Value	Labeling	Value	Labeling		
130	90	Video2 (Side)	CV/SVIDEO	34	CAMPOR_T_EN	0x01	Video Front (Campor_t)	0	Video Front (Campor_t)	0 (VIDE0)	2
131	91	Video1 (Rear)	CV/SVIDEO	39	REAR_AUX_EN	0x02	Rear Video (Aux)	1	Rear Video (Aux)	0 (VIDE0)	1
132	92	HDMI2	DTV	91	YPrPb2 EN = 1	0x04	S-Video Rear	2	S-Video Rear	0 (VIDE0)	5
			PC	91	YPrPb2 EN = 2	0x04	S-Video Rear	2	S-Video Rear	2 (COMPUTER)	5
133	93	HDMI1/DVI	DTV	35	COMPPORT EN = 1	0x08	Front Computer	3	Front Computer	0 (VIDE0)	3
			PC	35	COMPPORT EN = 2	0x08	Front Computer	3	Front Computer	2 (COMPUTER)	3
134	94	RGB	PC	87	REAR RGB EN = 2	0x10	SVGA Rear Computer	4	SVGA Rear Computer	2 (COMPUTER)	4
136	96	Component		38	YPrPb EN	0x40	Y/UV Component	6	Rear Y/PrPb Componen video	0 (VIDE0)	6
137	97	USB		121	USB Options	0x80	Y/C Front Video	6	Front S-Video	2 (Comp)	NA

## Troubleshooting

*Some quick and easy tips to resolving problems*

Symptoms	Possible Cause(s)	Possible Solution(s)
<b>Software Problems</b> Cannot direct enter channel number or "No Signal" appears.	Channel not included in channel scan in TV controller.	After 2-5-5 + MENU, only channels included in TV controller will appear. If channel is available it can be added to channel scan. If it is not available, the 'No Signal' message appears on the TV screen.

# Troubleshooting

*Some quick and easy tips to resolving problems*

Symptoms	Possible Cause(s)	Possible Solution(s)
<b>Power</b>		
No Power.	See troubleshooting flow chart.	
<b>Display Panel Picture</b>		
No Picture.	<ul style="list-style-type: none"><li>• Display panel is turned off.</li><li>• Antenna/Cable not connected.</li><li>• Connections incorrect.</li><li>• M.P.I. not connected.</li><li>• Encrypted program.</li><li>• Wrong tuning band.</li></ul>	<ul style="list-style-type: none"><li>-Turn TV on.</li><li>-Power failure?</li><li>-Connect Antenna/Cable signal to TV. (See Owners manual)</li><li>-Check connections on TV. (See Owners manual)</li><li>-If applicable, connect M.P.I. cable to M.P.I. device.</li><li>-Try another channel.</li><li>-Adjust Installer menu settings.</li></ul>
<b>Erratic Operation</b>		
Installer menu setup.	<ul style="list-style-type: none"><li>• Wrong Installer menu settings.</li></ul>	<ul style="list-style-type: none"><li>-Adjust Installer menu settings as required.</li></ul>
<b>Remote Control</b>		
Remote doesn't work.	<ul style="list-style-type: none"><li>• Remote not in TV mode.</li><li>• Not aimed at IR remote sensor.</li><li>• Remote too far from IR sensor.</li><li>• IR path to TV's receiver obstructed.</li><li>• Weak batteries.</li><li>• Wrong battery polarity.</li><li>• Too much light in room.</li><li>• Wrong Installer remote control.</li></ul>	<ul style="list-style-type: none"><li>-Use Mode key to select TV; puts remote into TV mode.</li><li>-Point remote at TV's IR receiver on TV.</li><li>-Move remote closer to TV's IR receiver or darken room.</li><li>-Remove obstructions.</li><li>-Replace batteries.</li><li>-Check that "+" and "-" match in battery compartment.</li><li>-Dim room light.</li><li>-Requires compatible Installer remote, contact your LG dealer.</li></ul>
<b>Picture Reception</b>		
Normal picture, poor or no sound.	<ul style="list-style-type: none"><li>• Audio muted.</li><li>• Broadcast problem.</li></ul>	<ul style="list-style-type: none"><li>-Press MUTE or use Volume Up key to increase sound level.</li><li>-Try a different channel.</li></ul>

Note: For other problems not caused by the TV, refer to other devices' operating guide.



**Warning:** Do not use LT2002 while any PPV card is installed in TV or clone programmer will be damaged.

### Note

The LT2002 programmer is designed to be used with TVs containing the 221-01006 and later processors. Use with earlier TV sets may give unpredictable results. Processors used before the 221-01006-04 have a limited screen display capability. They cannot display entire screens as shown in the quick setup instructions accompanying the LT2002 clone programmer. Use the printed menu illustrations on the quick setup sheet supplied with the Clone as an aid to making your programming choices. (Although the menus are not all displayed, the clone functions all operate normally.)

### Reset Clone After Static Shock

After replacing exhausted batteries, or if the programmer behaves strangely after a static shock, use a paper clip or similar instrument inserted through the small hole marked "RESET" to activate the internal reset switch and restore normal operation. After a reset, check the real-time clock setting. It may be necessary to reset the Clone Programmer clock from a TV containing the correct time.

## Clone Programmer Troubleshooting

Problem	Possible Cause(s)	Possible Solution(s)
<b>Clone Programmer</b>		
Clone copies Setup in less than 30 seconds	<ul style="list-style-type: none"> <li>• Not enough time to copy entire TV setup.</li> </ul>	<ul style="list-style-type: none"> <li>- Press Reset on clone programmer, redo teach/learn. (Teach/Learn should take a minimum of 1 minute.)</li> </ul>
Remote does not operate clone.	<ul style="list-style-type: none"> <li>• Wrong Installer remote.</li> </ul>	<ul style="list-style-type: none"> <li>- Only use an LG Installer remote to operate clone programmer with TV.</li> </ul>
LED does not blink.	<ul style="list-style-type: none"> <li>• M.P.I. cord not connected.</li> <li>• TV not turned on.</li> <li>• Weak batteries.</li> </ul>	<ul style="list-style-type: none"> <li>- Connect M.P.I. cord properly, assure good connection.</li> <li>- TV must be powered On for clone to work.</li> <li>- Install 4 fresh AA high-quality alkaline batteries.</li> </ul>
Clone menu hard to read.	<ul style="list-style-type: none"> <li>• Weak signal.</li> </ul>	<ul style="list-style-type: none"> <li>- Connect TV to a reliable Analog channel signal source.</li> </ul>
No time set.	<ul style="list-style-type: none"> <li>• Time not available.</li> </ul>	<ul style="list-style-type: none"> <li>- Set time on a TV, copy time to Clone Programmer.</li> </ul>
Clone not working.	<ul style="list-style-type: none"> <li>• Clone programmer problem.</li> </ul>	<ul style="list-style-type: none"> <li>- Try a different LT2002 Clone programmer.</li> <li>- Reset Clone Programmer.</li> </ul>
Clone Scans Channels more than once.	<ul style="list-style-type: none"> <li>• Clone should only scan channels once.</li> </ul>	<ul style="list-style-type: none"> <li>- Retry cloning again.</li> </ul>

### Master and Other TVs

Cloning did not work.	<ul style="list-style-type: none"> <li>• Procedure interrupted.</li> <li>• Different TV models.</li> <li>• Step(s) omitted or not performed.</li> </ul>	<ul style="list-style-type: none"> <li>- Wait until procedure complete message is displayed.</li> <li>- Cloning is only possible with identical model TVs.</li> <li>- Reread pages 7-8-9 to be sure all tasks were performed.</li> </ul>
Clone time disappeared.	<ul style="list-style-type: none"> <li>• Batteries were removed.</li> </ul>	<ul style="list-style-type: none"> <li>- Batteries must remain installed to retain time settings.</li> </ul>
New Setup not present.	<ul style="list-style-type: none"> <li>• TV not reset.</li> </ul>	<ul style="list-style-type: none"> <li>- Disconnect newly-cloned unit from power for 5 seconds.</li> </ul>

- After cloning operations are complete, just unplug the LT2002 from the TV.
- If the TV does not display a picture on the TV (blank screen) after a few seconds, just change channels.

# Troubleshooting Flow Chart

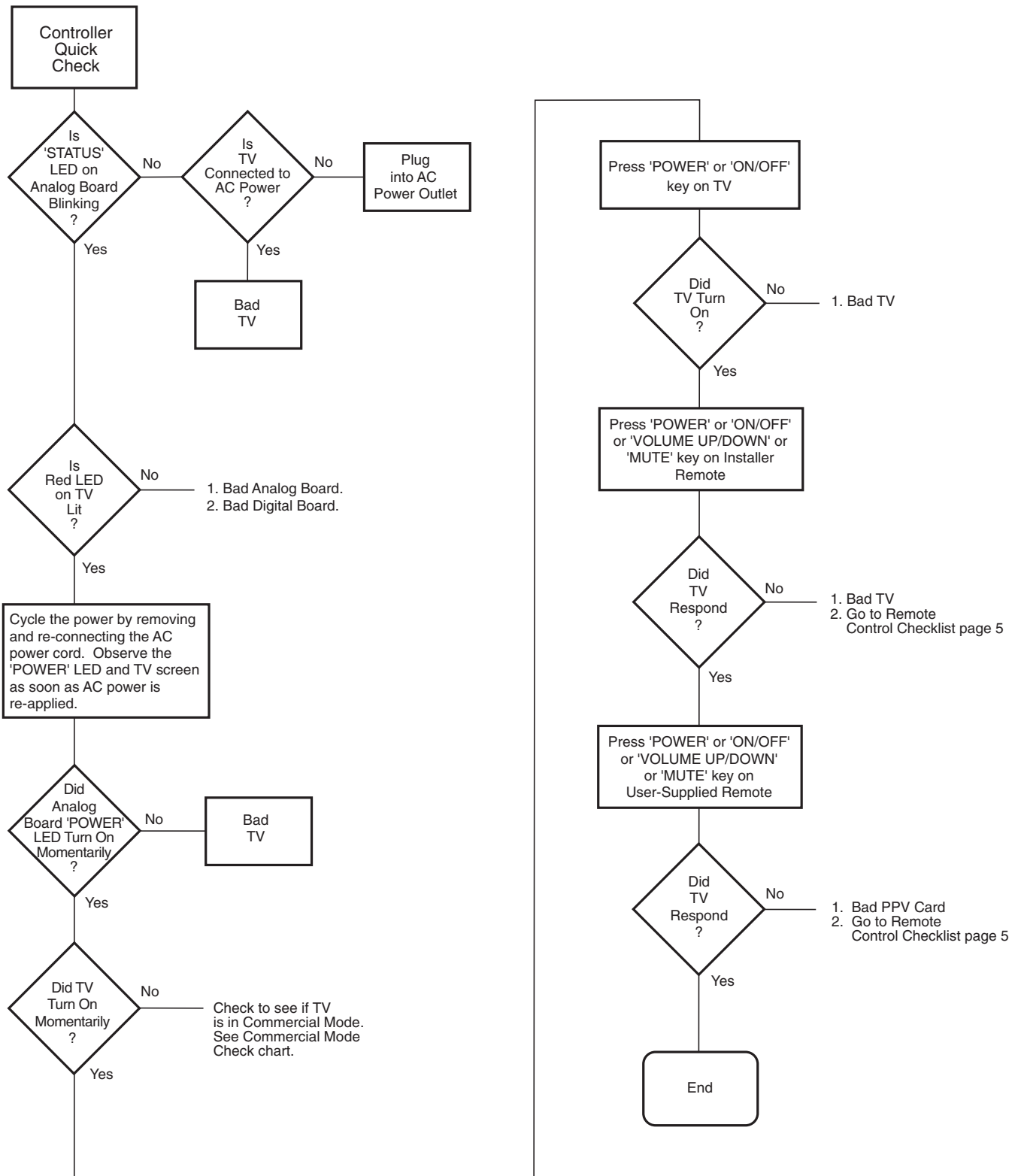

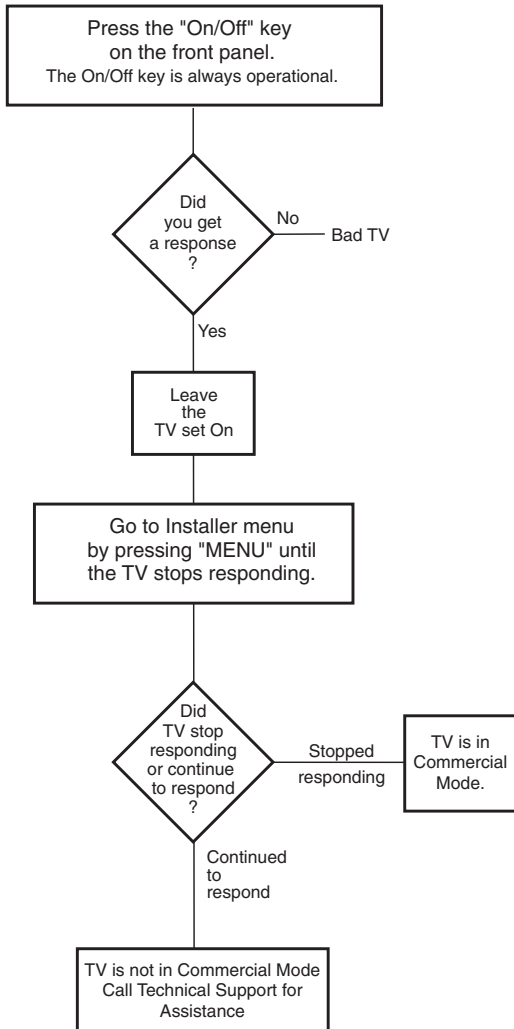



# Glossary of Terms

---

*A list of definitions for some of the words found in this guide*

## **75 OHM RF CABLE**

The wire that comes from an off-air antenna or cable service provider. The end looks like a hex-shaped nut with a wire sticking through the middle. It screws onto the Antenna/Cable threaded jack on the back of the TV.

## **300 TO 75 OHM ADAPTER**

A small device that connects a two-wire 300 ohm antenna to a 75 ohm RF jack. They are usually about an inch long with two screws on one end and a round opening with a wire sticking out on the other end.

## **A/V CABLES**

Audio/Video cables. Three cables bunched together—right audio (red), left audio (white), and video (yellow). A/V cables are used for stereo playback of videocassettes and for higher quality picture and sound from other A/V devices.

## **A/V DEVICE**

Any device that produces video or sound (VCR, DVD, cable box, or television).

## **AMPLIFIER**

An electronic device that amplifies sound from a television, CD player, VCR, DVD, or other Audio/Video device.

## **ANTENNA**

The physical receiver of television signals sent over the air. A large metal piece of equipment does not always have to be visible to be using an antenna.

## **B-LAN**

TV is controlled by external network.

## **CABLE**

Cable service box. Refers to the descrambler box cable subscribers use to receive cable programming signals.

## **CATV**

Programming provided by a cable service.

## **DIGITAL TELEVISION**

High-resolution, cinema-quality television signals transmitted digitally.

## **DVI**

Digital Video Interface  
Accommodates analog and digital interfaces with a single connector.

## **COMPOSITE VIDEO**

Typical video jack, uses one wire for transporting three-color video signals.

## **COMPONENT VIDEO**

Uses three wires for transporting three-color video signals. The end result is usually better video quality.

## **DELETED**

Lets you remove channels from the list that the end user can scroll through using CH (Channel) Up/Down.

## **HDMI**

High-definition multi-media interface.

## **HDTV**

High-definition television. Refers to television signals that have higher resolution than ordinary analog TV signals.

## **HDSTB**

High-definition set top box. Refers to a tuner device that receives high-definition television signals which have higher resolution than ordinary analog TV signals.

## **INPUT**

Refers to the input jack that receives a signal from a TV, VCR, DVD Player or other Audio/Video device.

## **JACK**

An input or output connector on the back of a TV, VCR, DVD Player or other Audio/Video device.

## **MONO SOUND**

Mono (monaural) sound is one channel of sound. On more than one speaker, all the speakers play the same audio.

## **OUTPUT**

Refers to the output jack that sends a signal out of a VCR, DVD, or other A/V device.

## **PHYSICAL CHANNEL NUMBER**

The actual channel number. Analog channels use the physical channel number and digital channels can use a virtual channel number.

## **RGB (Red, Green, Blue)**

Connection input or output port available for producing a video image using three separate colors: Red, Green, and Blue.

## **RS-232**

Serial communication port through which firmware is downloaded.

## **2ND AUDIO PROGRAMMING/SAP**

Second Audio Programming (SAP) is another, separate audio channel available with some programming. Choosing SAP often refers to listening to audio in another language, such as Spanish or French.

## **SIGNAL**

Picture and sound traveling through a cable, or over the air, to the TV.

## **STEREO SOUND**

Stereo (Stereophonic) sound refers to audio that's divided into right and left sides.

## **TUNER**

Device that picks up the broadcast signal and turns it into picture and sound.

## **VIRTUAL CHANNEL NUMBER**

A re-mapped channel number analog channels use the actual channel number. but digital channels use a virtual(or false) channel number.

## **XDS**

Extended Data Service: Additional program information included on the signal provided at the discretion of the broadcaster.

---

### Note 1

Refer to [www.atsc.org](http://www.atsc.org) for further information.

## B-LAN Setup and Overview (Except 32LH240H)

Power to the B-LAN module is controlled by Installer Menu Item 118 Power savings. By default, value 003, the B-LAN module is only powered on when the TV is powered on. There are two bits in the Power Savings item to control power to the B-LAN module, one for power during TV Standby mode and one for power during TV Power On mode. When the bit is 0, the B-LAN module is powered. When the bit is 1, the B-LAN module is not powered (Power Savings is Enabled).

Power Saving	TV Standby State		TV Power On State	
	BLAN Power	MPI Slot Power	BLAN Power	MPI Slot Power
1	On	Standby	On	Main
3	Off	Standby	On	Main
7	Off	Standby	Off	Main

The B-LAN module is internal to the TV. It allows the Hotel/Institution headend equipment to communicate with the TV for configuration and control. This communication is via the institution's RF distribution system. The control device at the headend (ex FMA-LG101) can control multiple TVs. When the TV is first installed, it must be powered on in order for the headend to be able to communicate with the B-LAN. At this point, if it is desired for the BLAN to always be powered on, particularly during Standby mode, the BLAN Standby Power Saving mode setting should be downloaded as Disabled. The new settings will not be active until the BLAN actually downloads the configuration data to the PTC and the PTC is reset.

If it known that the application requires only using the MPI card slot and not the embedded BLAN, the installer can go into the Installer Settings menu and enable the BLAN Power Savings mode, in both Standby and TV power on.

### RJP Model List

Legacy Models	Scaler Models
RJP-101M	Not Support PCB
RJP-101ML	Not Support PCB
RJP-110F	RJP-210F
RJP-110FW	RJP-210FW
RJP-110W	RJP-210W
RJP-110WBR	RJP-210WBR
RJP-110S	RJP-210S
RJP-120G	RJP-220G
RJP-120T	RJP-220T
RJP-201B	RJP-301B
RJP-202B	RJP-302B

### RJP Input Hierarchy

Priority	Video	Audio
1st. (Highest)	HDMI / DVI	3.5mm Mini Jack
2nd.	RGB	L / R Audio In
3rd.	Composite	HDMI / DVI
4th. (Lowest)	TV (RF or Aux)	TV (RF or Aux)

**LG Electronics Inc.**

## Free Manuals Download Website

<http://myh66.com>

<http://usermanuals.us>

<http://www.somanuals.com>

<http://www.4manuals.cc>

<http://www.manual-lib.com>

<http://www.404manual.com>

<http://www.luxmanual.com>

<http://aubethermostatmanual.com>

Golf course search by state

<http://golfingnear.com>

Email search by domain

<http://emailbydomain.com>

Auto manuals search

<http://auto.somanuals.com>

TV manuals search

<http://tv.somanuals.com>