

Operating Guide | Warranty

Model Number | Z15LA7R • Z20LA7R | LCD TV



© Copyright 2004, LG Electronics USA, Inc.

Warning



WARNING:

TO REDUCE THE RISK OF ELECTRIC SHOCK DO NOT REMOVE COVER (OR BACK). NO USER SERVICEABLE PARTS INSIDE. REFER TO QUALIFIED SERVICE PERSONNEL.



The lightning flash with arrowhead symbol, within an equilateral triangle, is intended to alert the user to the presence of uninsulated "dangerous voltage" within the product's enclosure that may be of sufficient magnitude to constitute a risk of electric shock to persons.



The exclamation point within an equilateral triangle is intended to alert the user to the presence of important operating and maintenance (servicing) instructions in the literature accompanying the appliance.

NOTE TO CABLE/TV INSTALLER:

This reminder is provided to call the CATV system installer's attention to Article 820-40 of the National Electric Code (U.S.A.). The code provides guidelines for proper grounding and, in particular, specifies that the cable ground shall be connected to the grounding system of the building, as close to the point of the cable entry as practical.

REGULATORY INFORMATION

This equipment has been tested and found to comply with the limits for a Class B digital device, pursuant to Part 15 of the FCC Rules. These limits are designed to provide reasonable protection against harmful interference in a residential installation. This equipment generates, uses and can radiate radio frequency energy and, if not installed and used in accordance with the instructions, may cause harmful interference to radio communications. However, there is no guarantee that interference will not occur in a particular installation. If this equipment does cause harmful interference to radio or television reception, which can be determined by turning the equipment off and on, the user is encouraged to try to correct the interference by one or more of the following measures:

- Reorient or relocate the receiving antenna.
- Increase the separation between the equipment and receiver.
- Connect the equipment into an outlet on a circuit different from that to which the receiver is connected.
- Consult the dealer or an experienced radio/TV technician for help.

Any changes or modifications not expressly approved by the party responsible for compliance could void the user's authority to operate the equipment.

CAUTION:

Do not attempt to modify this product in any way without written authorization from LG Electronics Corporation. Unauthorized modification could void the user's authority to operate this product.

COMPLIANCE:

The responsible party for this device compliance is:

Zenith Electronics Corporation

1-201-816-2000

Marked and Distributed in the United States by LG Electronics U.S.A., Inc.

1000 Sylvan Avenue, Englewood Cliffs, NJ 07632

<http://www.zenith.com>

Safety Instructions

WARNING :

To reduce the risk of fire or electric shock, DO NOT expose this apparatus to rain or moisture.

Apparatus shall not be exposed to dripping or splashing and no objects filled with liquids, such as vases, shall be placed on the apparatus.

CAUTION :

These servicing instructions are for use by qualified service personnel only. To reduce the risk of electric shock, do not perform any servicing other than that contained in the operating instructions unless you are qualified to do so.

IMPORTANT SAFETY INSTRUCTIONS

1. Read these instructions.
2. Keep these instructions.
3. Heed all warnings.
4. Follow all instructions.
5. Do not use this apparatus near water.
6. Clean only with a dry cloth.
7. Do not block any of the ventilation openings. Install in accordance with the manufacturer's instructions.
8. Do not install near any heat sources such as radiators, heat registers, stoves, or other apparatus (including amplifiers) that produce heat.
9. Do not defeat the safety purpose of the polarized or grounding type plug. A polarized plug has two blades with one wider than the other. A grounding type plug has two blades and a third grounding prong. The wide blade or the third prong is provided for your safety. When the provided plug does not fit into your outlet, consult an electrician for replacement of the obsolete outlet.
10. Protect the power cord from being walked on or pinched particularly at plugs, convenience receptacles, and the point where they exit from the apparatus.
11. Only use the attachments / accessories specified by the manufacturer.

Safety Instructions continued

12. Use only with a cart, stand, tripod, bracket, or table specified by the manufacturer, or sold with the apparatus. When a cart is used, use caution when moving the cart / apparatus combination to avoid injury from tip-over.



13. Unplug this apparatus during lightning storms or when unused for long periods of time.
14. Refer all servicing to qualified service personnel. Servicing is required when the apparatus has been damaged in any way, such as power supply cord or plug is damaged, liquid has been spilled or objects have fallen into the apparatus, the apparatus has been exposed to rain or moisture, does not operate normally, or has been dropped.

On Disposal

- a. The fluorescent lamp used in this product contains a small amount of mercury.
- b. Do not dispose of this product with general household waste.
Disposal of this product must be carried out in accordance to the regulations of your local authority.

Contents

Warnings	2	Sound Menu Options	
Safety Instructions	3~4	EZ Audio	19
Introduction		Equalizer Adjustments	19
Controls	6	AVL (Auto Volume Leveler)	19
Connection Options	7	Sound Balance	19
Remote Control Key Functions	8	Stereo/SAP Broadcasts Setup	19
Installation		Time Menu Options	
Accessories	9	Auto Clock Setup	20
Kensington Security System	9	Manual Clock Setup	20
Installation Instruction	10	On/Off Timer Setup	21
External Equipment Connections	11~14	Sleep Timer Setup	21
Antenna Connection	11	Auto Off	21
VCR Setup	12	Special Menu Options	
Cable TV Setup	12	Closed Captions	22
DTV Setup	13	Caption/Text	23
External A/V Source Setup	13	Captions	23
DVD Setup	13	Key Lock	23
Using Headphones	14	Lock Options	24
PC Setup	14	Lock Menu Setup	25
Operation		Maintenance	26
PC Menu Options	15	Product Specifications	26
TV Operation Overview	16	Troubleshooting Checklist	27
Menu Language Selection	16		
Channel Menu Options			
Memorizing the Channels with EZ Scan	17		
Add/Delete Channels with Manual Program	17		
Favorite Channels Setup	17		
Picture Menu Options			
EZ Video	18		
Manual Picture Control (User option)	18		

Introduction

Controls

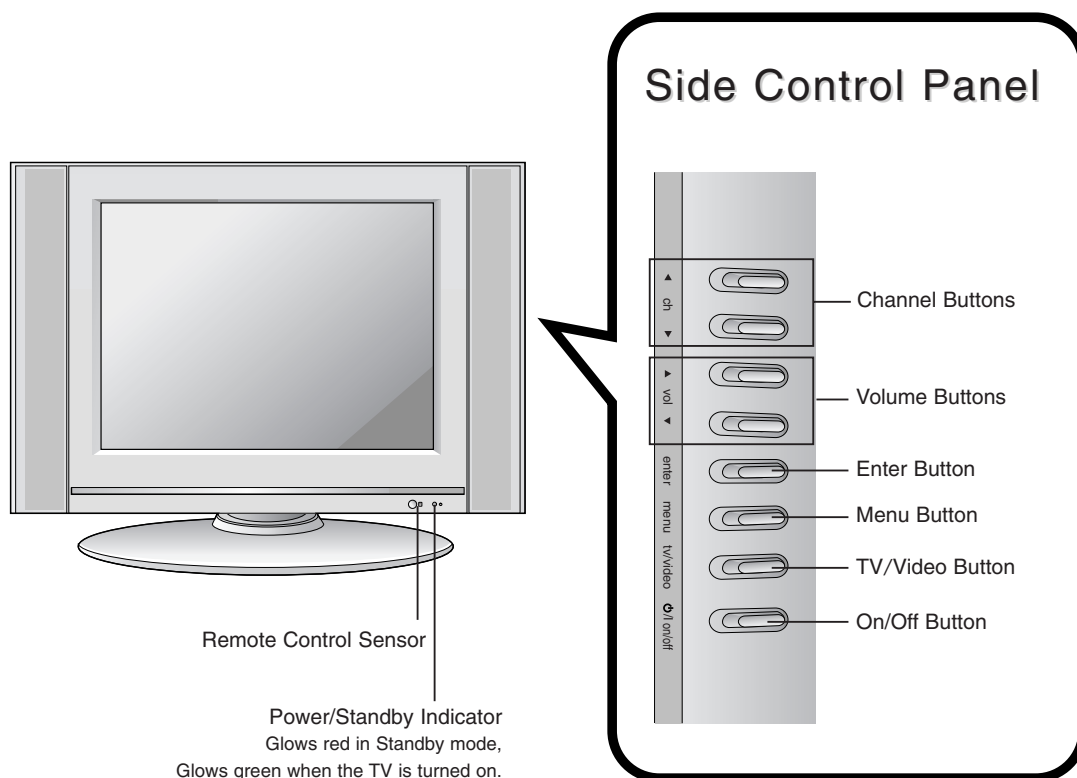

Connection Options

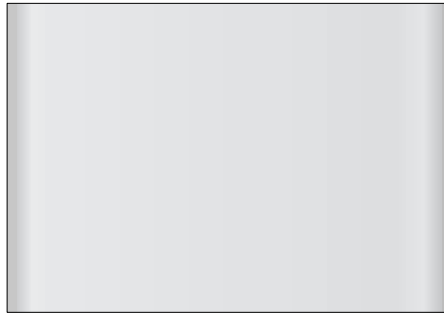

* Kensington Security
System Connector
(Refer to P.9)

Remote Control Key Functions

- When using the remote control, aim it at the remote control sensor on the TV.

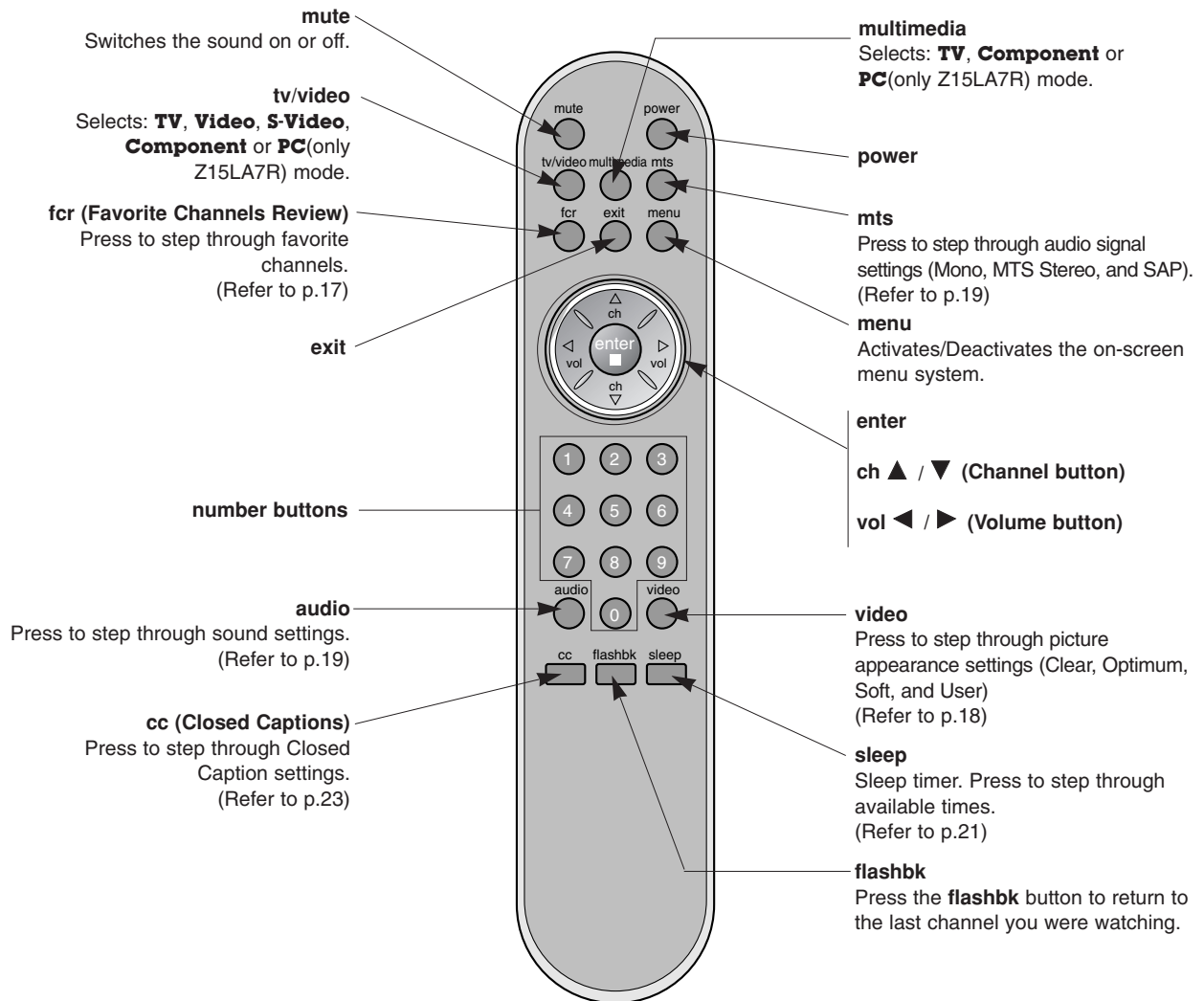

Installing Batteries

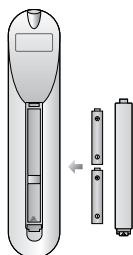

- Open the battery compartment cover on the back side and insert the batteries with correct polarity.
- Install two 1.5V batteries of AAA type. Don't mix used batteries with new batteries.

Installation

Accessories

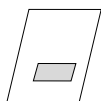

Owner's Manual

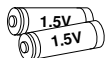

AAA Batteries



Power Cord

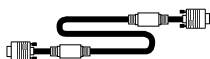

Remote Control

PC Signal Cable
(Z15LA7R Only)PC Sound Cable
(Z15LA7R Only)Tie Bands
- Arrange the wires
with the tie bands.

NOTES

- If the TV feels cold to the touch, there may be a small "flicker" when it is turned on. This is normal, there is nothing wrong with TV.
- Some minute dot defects may be visible on the screen, appearing as tiny red, green, or blue spots. However, they have no adverse effect on the monitor's performance.
- Avoid touching the LCD screen or holding your finger(s) against it for long periods of time. Doing so may produce some temporary distortion effects on the screen.

Kensington Security System

- Note: The Kensington Security System is an optional accessory.
- The TV is equipped with a Kensington Security System connector on the back panel. Connect the Kensington Security System cable as shown below.
- For the detailed installation and use of the Kensington Security System, refer to the user's guide provided with the Kensington Security System.
For further information, contact <http://www.kensington.com>, the internet homepage of the Kensington company. Kensington sells security systems for expensive electronic equipment such as notebook PCs and LCD projectors.

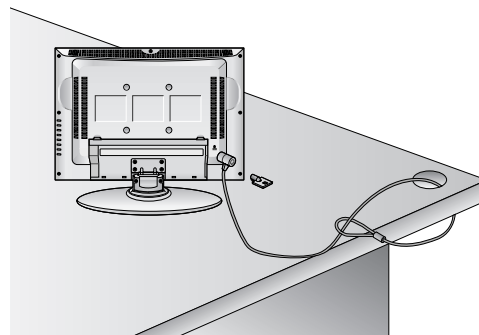

Installation Instruction

Rear A/V Cover

- * The connection panel is hidden behind the A/V cover.
- a. Remove the cover.
- b. Install wires as necessary.
- c. Reinstall the cover. Align the holes on the TV back panel with the two tabs on the rear A/V cover as shown.
- d. Close cover.

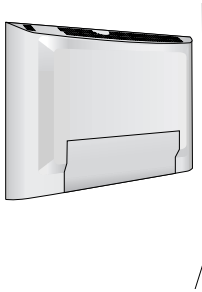

Wire Holders

- Thread, then pull the wires through the hole on the TV stand.

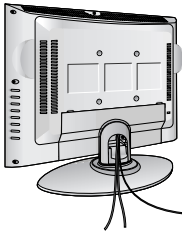

Adjusting the TV Viewing Angle

- You can adjust the vertical angle of the TV between -3° and 12° .

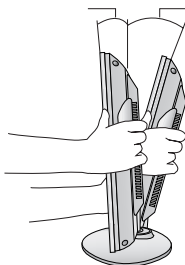

External Equipment Connections

- This manual mainly explains the features for the Z15LA7R.

- For optimum picture quality, adjust antenna direction.

Connecting to an Inside Antenna Setup

- Typical wall antenna jack used in apartment buildings, connect the antenna cable as shown below. (Use the correct type of antenna cable for the type of wall antenna jack.)

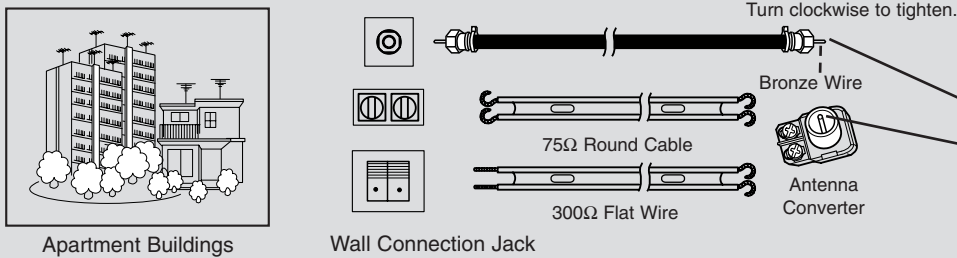

- If you have a 75Ω round cable, insert the bronze wire and then tighten the connection nut. If you have a 300Ω flat wire, twist the twisted wire to the antenna converter and then connect the converter to the antenna jack on the wall. When using 75Ω round cable, do not bend the bronze wire. It may cause poor picture quality.

Outdoor Antenna Setup

used in single family dwellings.

UHF Antenna

75Ω Round Cable

300Ω Flat Wire

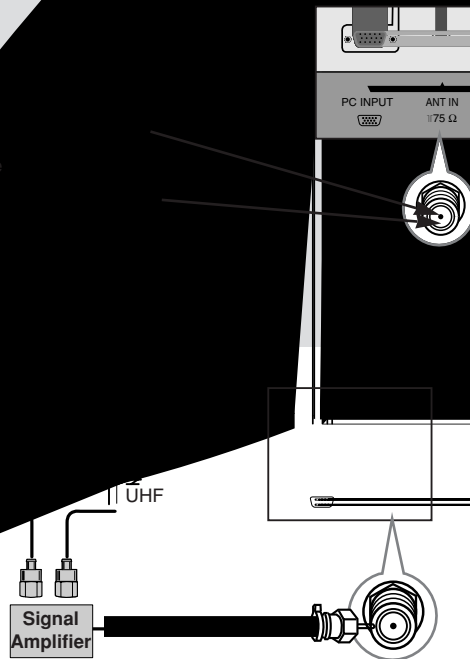

VCR Setup

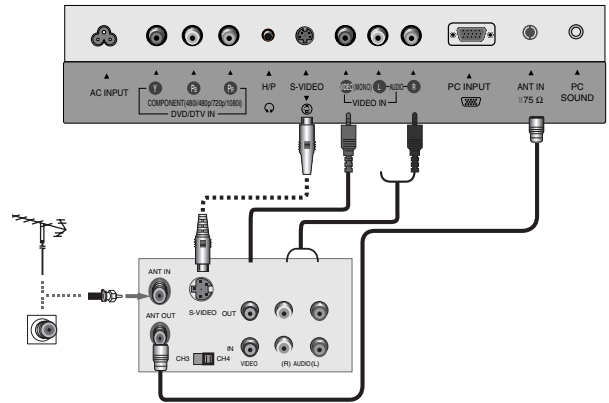

Cable TV Setup

Connection 1

1. Connect the coaxial cable output on the cable box to the antenna input on the TV.
2. Connect the coaxial cable from the wall to the input on the cable box.
3. Set the channel switch to 3 or 4 and then tune TV to the same channel number.

Connection 2

1. Connect your cable input of the cable box.
2. Connect the audio/video output jacks on the cable box to the corresponding input jacks on the TV, match the jack colors (Video = yellow, Audio Left = white, and Audio Right = red).
3. Use the **tv/video** button on the remote control to select **Video**.
If connected to **S-VIDEO** on side panel, select the **S-Video** external input source.

Important Note: If your cable box has Component Video outputs or DVI, it is recommended you use those connections for the best quality picture. High Definition input on this LCD TV is only supported on these two connections. When using DVI there are three connections to each device, the DVI cable plus the two audio cables. When using Component there are five connections to each device, the red, green, and blue video cables plus the red and white audio cables.

DTV Setup

- To watch digitally broadcast programs, purchase and connect a digital set-top box.

Connections

Connect the digital set-top box video outputs to the COMPONENT (Y, PB, PR) jacks and connect the digital set-top box audio outputs to the AUDIO jacks.

Viewing Setup

1. Turn on the digital set-top box. (Refer to the owner's manual for the digital set-top box.)
2. Use the **tv/video** or **multimedia** button on the remote control to select **Component**.

External A/V Source Setup

Connections

Connect the audio/video output jacks on the external A/V equipment to the corresponding input jacks on the TV. When connecting the TV to external A/V equipment, match the jack colors (Video = yellow, Audio Left = white, and Audio Right = red).

Viewing Setup

1. Turn on the external A/V equipment.
2. Use the **tv/video** button on the remote control to select **Video**.
3. Operate the corresponding external equipment. Refer to external equipment operating guide.

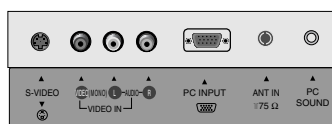

Camcorder

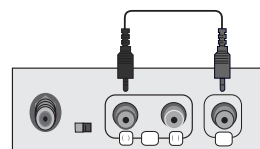

Video Game set

DVD Setup

Connections

1. Connect the DVD video outputs to the COMPONENT (Y, PB, PR) jacks and connect the DVD audio outputs to the AUDIO jacks.
2. Component Video jacks on other devices may not be labeled the same as they are on this TV, refer to the chart below for a list of other labeling schemes.

NOTE: If your DVD player does not have component video output, use S-Video.

Viewing Setup

1. Turn on the DVD player, insert a DVD.
2. Use the **tv/video** or **multimedia** button on the remote control to select **Component** (If connected to S-VIDEO, select the **S-Video** input source.)
3. Refer to the DVD player's manual for operating instructions.

DVD

Using Headphones

- Plug headphones in to H/P jack as shown.
- Adjust sound level to a headphone using the volume (◀, ▶) buttons. While you are listening to sound through a headphone(s) TV speakers are shut off.

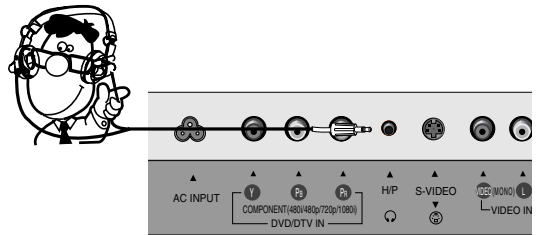

PC Setup (Z15LA7R Only)

- After setup, be sure to select PC source on TV.

Connections

1. Set the monitor output resolution on the PC before connecting to the TV.
2. Connect the TV to the PC with the PC cable.
3. Connect the PC audio output to the TV's PC SOUND input.

Viewing Setup

1. Turn on the PC.
2. Use the **tv/video** or **multimedia** button on the remote control to select **PC**.

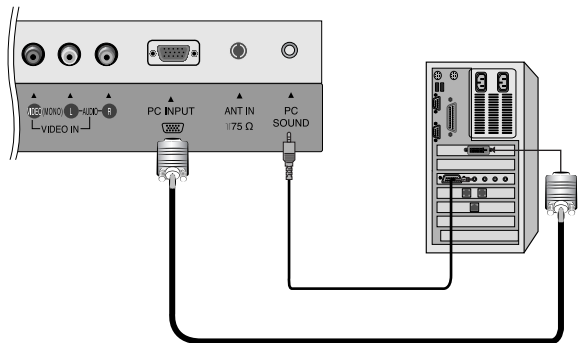

Monitor Display Specifications

Resolution	Horizontal Frequency(kHz)	Vertical Frequency(Hz)
640x480	31.47	60
	35.00	66.67
	37.50	75
800x600	35.16	56.25
	37.88	60
	48.08	72.19
	46.88	75
1024x768	48.36	60
	56.48	70
	60.02	75

NOTES

- a. For optimum picture quality, use standard XGA (1024x768) computer output at a 60Hz refresh rate. Using other formats (VGA, SVGA, etc.) or refresh rates may result in reduced picture quality. (To change the computer video output format, please refer to the operating manual for the computer you are using).
- b. If the message **"Out of range"** appears on the screen, adjust the PC output to a format listed in the 'Displayable Monitor Output Format Specifications' chart above.
- c. The synchronization input form for Horizontal and Vertical frequencies is separate.

DPM (Display Power Management) mode

If the PC goes to power saving mode, the monitor automatically switches to DPM mode. DPM mode may not work if you don't use the PC cable provided.

Operation

PC Menu Options (Z15LA7R Only)

- After setup, be sure to select PC source to see the PC image on TV screen.

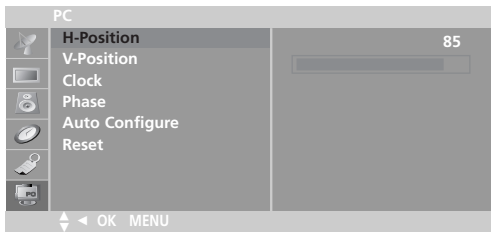

1. Press the **menu** button and then use **▲ / ▼** button to select the **PC** menu.
2. Press the **▶** button and then use **▲ / ▼** button to select desired item.
3. Use the **◀ / ▶** button to make appropriate adjustments.
 - H-position/V-position
 - Adjusts picture left/right and up/down.
 - The adjustment ranges of H-Position is 0~100.
 - (Based on the input mode, the adjustment range may change.)
 - Clock
 - Minimizes any vertical bars or stripes appearing on the screen background.
 - The adjustment range is 0~100. (Based on the input mode, the adjustment range may change.)
 - Phase
 - Remove any horizontal noise and clear up or sharpen the character images.
 - The range adjustment is 0~100. (Based on the input mode, the adjustment range may change.)
 - Auto-configure
 - Automatically adjusts the screen position, clock, and clock phase.
 - (The displayed image will disappear for a few seconds while Auto-configuration is in progress.)
 - Reset
 - Returns to the default settings programmed at the factory; default settings cannot be changed.
4. Press the **enter** button to save.

TV Operation Overview

1. First, make all equipment connections. Plug the AC Adapter into the TV, then plug the AC Adapter into a power outlet. At this time, the TV is switched to standby mode.
 - In standby mode, press the **power**, **ch** (▲, ▼), **tv/video**, **multimedia** or a **number** button on the remote control or **on/off**, **ch** (▲, ▼), **tv/video** located on the TV to turn the TV on.
2. Select the viewing source by pressing **tv/video** or **multimedia** repeatedly.
 - Note: See page 16 if you have not auto programmed the TV to receive channels in your local broadcast area.
3. After viewing, press the **power** button on the remote control or **on/off** located on the TV. The TV reverts to standby mode.

NOTE

- If you want to turn the TV off, press the on/off button located on the TV. If you intend to be away on vacation, disconnect the power plug from the wall power outlet.

Menu Language Selection

- The menus can be shown on the screen in the selected language. First select your language.

1. Press the **menu** button and then use ▲ / ▼ button to select the **Special** menu.
2. Press the ► button and then use ▲ / ▼ button to select **Language**.
3. Press the ► button and then use ▲ / ▼ button to select your desired language.
From this point on, the on-screen menus will be shown in the language of your choice.
4. Press the **exit** button to save and return to TV viewing.

Channel Menu Options

Memorizing the Channels with EZ Scan

- For Auto program to work, the programming source must be connected to the TV and the TV must be receiving programming signals either over-the-air or from a cable-type service provider.

1. Press the **menu** button and then use ▲ / ▼ button to select the **Channel** menu.
2. Press the ► button and then use ▲ / ▼ button to select **EZ Scan**.
3. Press the ► button to begin the channel search.
 - Wait for auto program to complete the channel search cycle before choosing a channel. The TV scans for over-the-air channels and then channels provided by a cable service.



NOTES

- When the channel search is complete, use the ▲ / ▼ buttons to review the memorized channels.
- If you press the **enter** button in auto programming, the function will stop and only channels programming up to that time will remain.
- Auto program function can memorize only the channels which are being received at that time.

Add/Delete Channels with Manual Program

- You can manually include or erase individual channels.

1. Press the **menu** button and then use ▲ / ▼ button to select the **Channel** menu.
2. Press the ► button and then use ▲ / ▼ button to select **Manual prog.**
3. Press the ► button and then use ◀ / ▶ button to select a channel you want to add to memory or erase.
4. Press the ▼ button and then use ◀ / ▶ button to select **Memory (add)** or **Erase (delete)**.
5. Press the **enter** button to save. The current channel is added to Memory or Erased from the channel list.



Picture Menu Options

EZ Video

- This function adjusts the TV for the best picture appearance.

1. Press the **video** button repeatedly to select the picture appearance setup option as shown below.

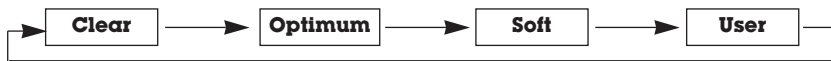

- You can also adjust **EZ Video** in the **Picture** menu.
- **Clear**, **Optimum** and **Soft** are preset for good picture quality at the factory and cannot be changed.

Manual Picture Control (**User** option)

- You can adjust picture contrast, brightness, color, sharpness and tint to the levels you prefer.

1. Press the **menu** button and then use **▲** / **▼** button to select the **Picture** menu.
2. Press the **▶** button and then use **▲** / **▼** button to select the desired picture option (**Contrast**, **Brightness**, **Color**, **Sharpness**, **Tint**).
3. Use the **◀** / **▶** button to make appropriate adjustments.
 - Contrast, Brightness, Color, and Sharpness are adjustable from 0 to 100.
 - Tint is adjustable from - 50 to + 50.
4. Press the **enter** button to save.



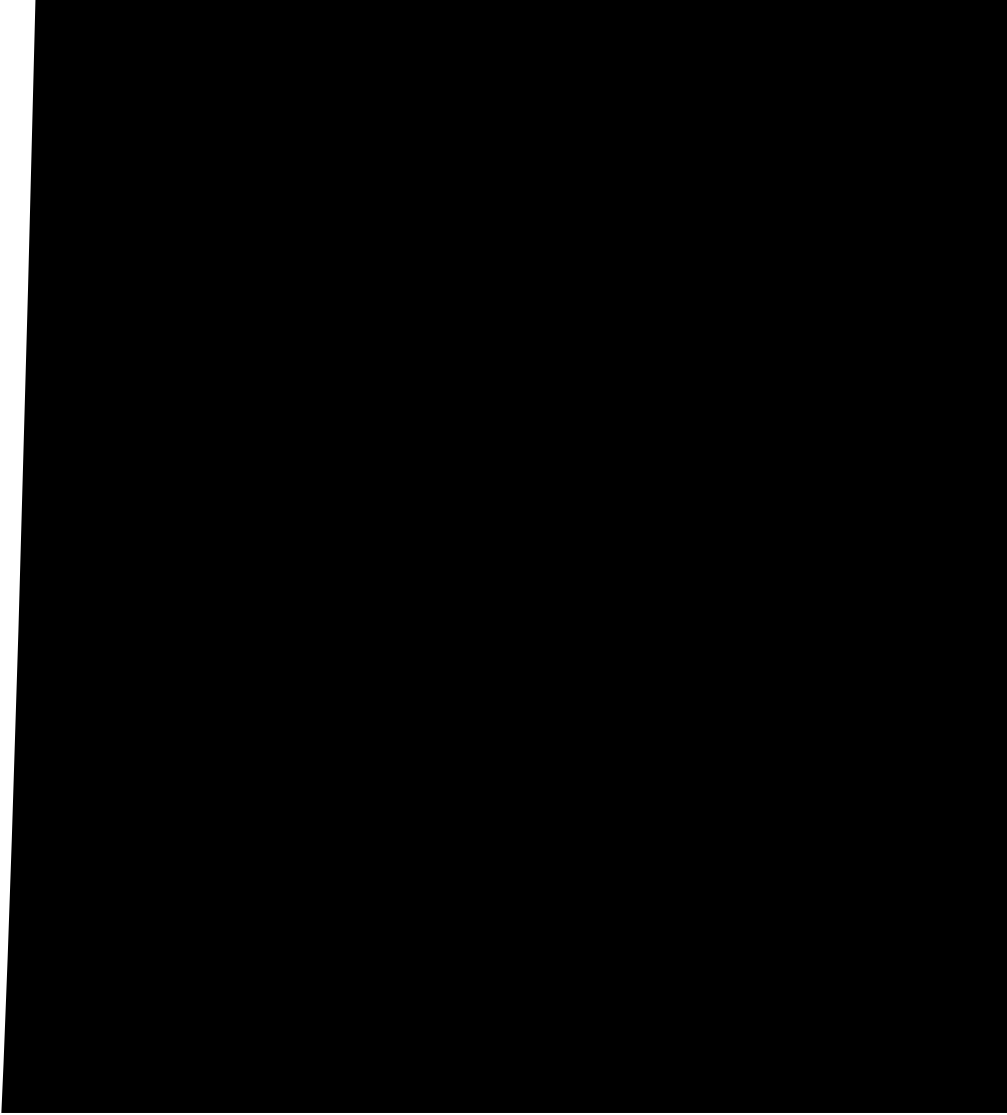

Timer Menu Options

Auto Clock Setup

- The time can be automatically set using information from your local PBS TV station. The PBS channel signal includes information for the correct time and daylight savings time.

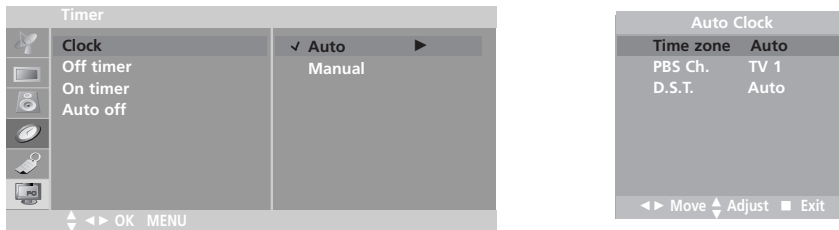

1. Press the **menu** button and then use ▲ / ▼ button to select the **Timer** menu.
2. Press the ► button and then use ▲ / ▼ button to select **Clock**.
3. Press the ► button and then use ▲ / ▼ button to select **Auto**.
4. Press the ► button and then use ▲ / ▼ button to select the time zone for your viewing area. Your choices are: **Auto**, **E.S.T. (Eastern Standard Time)**, **C.S.T. (Central Standard Time)**, **M.S.T. (Mountain Standard Time)**, **P.S.T. (Pacific Standard Time)**, **Alaska**, and **Hawaii**.
5. Press the ► button and then use ▲ / ▼ button to set **PBS channel**.
6. Press the ► button and then use ▲ / ▼ button to set **D.S.T. (Daylight Savings Time)** **Auto**, **Off** or **On**, depending on whether or not your viewing area observes Daylight Savings Time.
7. Press the **enter** button to save.

Manual Clock Setup

- If the time on the clock is incorrect, reset the clock manually.

1. Press the **menu** button and then use ▲ / ▼ button to select the **Timer** menu.
2. Press the ► button and then use ▲ / ▼ button to select **Clock**.
3. Press the ► button and then use ▲ / ▼ button to select **Manual**.
4. Press the ► button and then use ▲ / ▼ button to set the hour.
5. Press the ► button and then use ▲ / ▼ button to set the minutes.
6. Press the **enter** button to save.

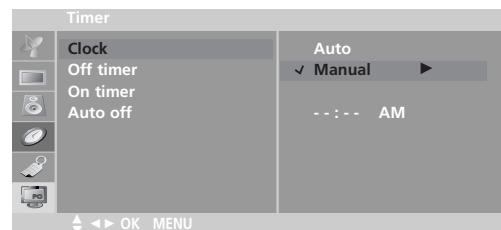

On/Off Timer Setup

- Timer function operates only if current time is set.
- Off-Timer function overrides On-Timer function if they are set to the same time.
- The TV must be in standby mode for the On-Timer to work.
- If you don't press any button within 2 hours after turning on the TV with the On-Timer function, the TV will automatically revert to standby mode.

1. Press the **menu** button and then use **▲ / ▼** button to select the **Timer** menu.
2. Press the **▶** button and then use **▲ / ▼** button to select **Off timer** or **On timer**.
3. Press the **▶** button and then use **▲ / ▼** button to set the hour.
4. Press the **▶** button and then use **▲ / ▼** button to set the minutes.
5. **For On timer function only:**
 Press the **▶** button and then use **▲ / ▼** button to set the channel at turn-on.
 Then, press the **▶** button and then use **▲ / ▼** button to set the turn-on sound level.
6. Press the **▶** button and then use **▲ / ▼** button to select **Run** or **Hold**.
 - **Hold:** **Off timer/On timer** will not work.
 - Run:** **Off timer/On timer** are active.
7. Press the **enter** button to save.

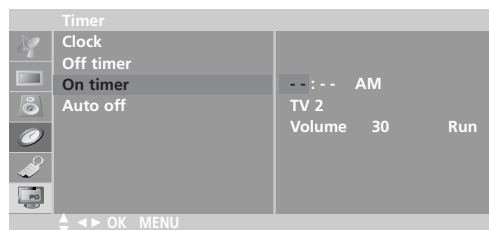

Sleep Timer Setup

- The Sleep Timer turns the TV off at a preset time.
1. Press the **sleep** button repeatedly to select the number of minutes. First the **Sleep ---** option appears on the screen, followed by the following sleep timer options: 10, 20, 30, 60, 90, 120, 180, and 240 minutes.
 2. When the number of minutes you want is displayed on the screen, press the **enter** button. The timer begins to count down from the number of minutes selected.
 3. To check the remaining minutes before the TV turns off, press the **sleep** button once.
 4. To cancel the Sleep Timer, press the **sleep** button repeatedly until **Sleep ---** appears.

Auto Off

- If Auto Off is active and there is no input signal, the TV switches to Standby mode automatically after 10 minutes.

1. Press the **menu** button and then use **▲ / ▼** button to select the **Timer** menu.
2. Press the **▶** button and then use **▲ / ▼** button to select **Auto off**.
3. Press the **▶** button and then use **▲ / ▼** button to select **On** or **Off**.
4. Press the **enter** button to save.

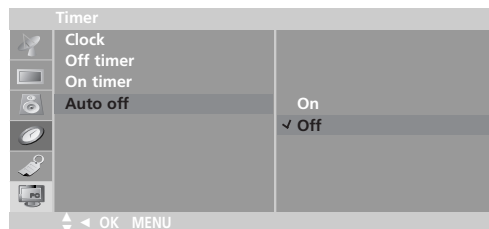

Special Menu Options

Closed Captions

Closed captioning is a process which converts the audio portion of a television program into written words which then appear as subtitles on the television screen. Closed captions allow viewers to read the dialogue and narration of television programs.

Using Closed Captions

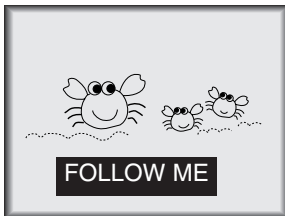

Captions are the subtitles of the dialogue and narration of television programs. For prerecorded programs, program dialogue can be arranged into captions in advance. Its possible to caption a live program by using a process called real-time captioning, which creates captions instantly. Real-time captioning is normally done by professional reporters using a machine shorthand system and computer for translation into English.

Captioning is an effective system for the hearing-impaired, and it can also aid in teaching language skills.

- The picture at left shows a typical caption.

Caption Tips

- Not all TV broadcasts include closed caption signals.
- Sometimes TV stations broadcast four different caption signals on the same channel. By selecting **From CC 1 to CC 4**, you can choose which signal you view. **CC 1** is usually the signal with the captions, while **Another mode** might show demonstration or programming information.
- Your TV might not receive caption signals normally in the following situations.

1. Poor reception conditions are encountered:



- **IGNITION:**

Picture may flutter, drift, suffer from black spots, or horizontal streaking. Usually caused by interference from automobile ignition systems, neon lamps, electrical drills, and other electrical appliances.



- **GHOSTS:**

Ghosts are caused when the TV signal splits and follows two paths. One is the direct path and the other is reflected off tall buildings, hills or other objects. Changing the direction or position of the antenna may improve reception.



- **SNOW:**

If your receiver is located at the weak, fringe area of a TV signal, your picture may be marred by small dots. It may be necessary to install a special antenna to improve the picture.

2. An old, bad, or illegally recorded tape is being played.
3. Strong, random signals from a car or airplane interfere with the TV signal.
4. The signal from the antenna is weak.
5. The program wasn't captioned when it was produced, transmitted, or taped.

Caption/Text

1. Press the **menu** button and then use ▲ / ▼ button to select the **SPECIAL** menu.
2. Press the ► button and then use ▲ / ▼ button to select **Caption / Text**.
3. Press the ► button and then use ▲ / ▼ button to select caption: **CC1, CC2, CC3, CC4, Text1, Text2, Text3, or Text4**.

• **CAPTION**

The term for the words that scroll across the bottom of the TV screen; usually the audio portion of the program provided for the hearing impaired.

• **TEXT**

The term for the words that appear in a large black frame and almost cover the entire screen; usually messages provided by the broadcaster.

4. Press the **enter** button to save.

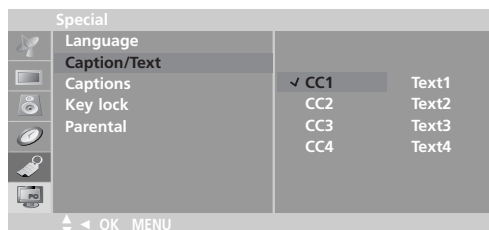

Captions

1. Use the **cc** button repeatedly to select Caption **Off, EZ Mute, or On**.
 - **EZ Mute** shows the selected captions option (if available on program) when the TV sound is muted
2. Press the **enter** button to save.

Key Lock

- The TV can be set up so that it can only be used with the remote control to prevent unauthorized viewing.

1. Press the **menu** button and then use ▲ / ▼ button to select the **Special** menu.
2. Press the ► button and then use ▲ / ▼ button to select **Key lock**.
3. Press the ► button and then use ▲ / ▼ button to select **On** or **Off**.
4. Press the **enter** button to save.

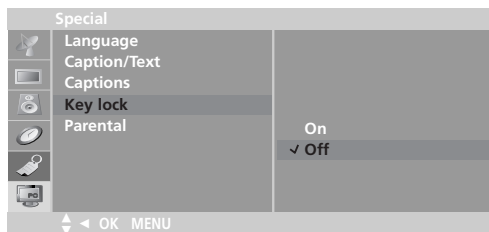

Lock Options

Parental Control can be used to block specific channels, ratings and other viewing sources.

The Parental Control Function (V-Chip) is used to block program viewing based on the ratings sent by the broadcast station. The default setting is to allow all programs to be viewed. Viewing can be blocked by the type of program and by the categories chosen to be blocked. It is also possible to block all program viewing for a time period. To use this function, the following must be set :

1. Ratings and categories to be blocked.
2. Set a password
3. Enable the lock

V-Chip rating and categories

Rating guidelines are provided by broadcast stations. Most television programs and television movies can be blocked by TV Rating and/or Individual Categories. Movies that have been shown at the theaters or direct-to-video movies use the Movie Rating System (MPAA) only.

For Movies previously shown in theaters :

Movie Ratings :

- Unblocked
- G and Above (general audience)
- PG and Above (parental guidance suggested)
- PG-13 and Above (13 years and older)
- R and above (restricted)
- NC-17 and Above (18 years and older)
- X (adult)

If you set PG-13 and Above : G and PG movies will be available , PG-13, R, NC-17 and X will be blocked.

For Television programs including made-for-TV movies:

General TV Ratings:

- Unblocked
- TV-G and Above (general audience) (individual categories do not apply)
- TV-PG and Above (parental guidance suggested)
- TV-14 and Above (14 years and older)
- TV-MA (mature audience)

Children TV Ratings:

- Unblocked
- TV-Y and Above (youth) (individual content categories do not apply)
- TV-Y7 (youth, 7 years and up)

Content Categories:

- Dialog - sexual dialogue (applies to TV-PG and Above, TV-14)
- Language - adult language (applies to TV-PG and Above, TV-14 and Above, TV-MA)
- Sex scenes - sexual situations (applies to TV-PG and Above, TV-14 and Above, TV-MA)
- Violence (applies to TV-PG and Above, TV-14 and Above, TV-MA)
- F Violence - fantasy violence (applies only to TV-Y7)
- No Rating (blocks all viewing)

For Canadian English/French language rating system:

Canadian English language rating system:

- C & Above (Children)
- C8+ (8 years and older)
- G & Above (General programming. Suitable for all audiences.)
- PG & Above (Parental guidance suggested)
- 14+ (Viewer 14 years and older)
- 18+ (Adult programming)

Canadian French language rating system:

- G & Above (General)
- 8 ans+ (8 years and older)
- 13 ans+ (13 years and older)
- 16 ans+ (16 years and older)
- 18 ans+ (Adults only)

Lock Menu Setup

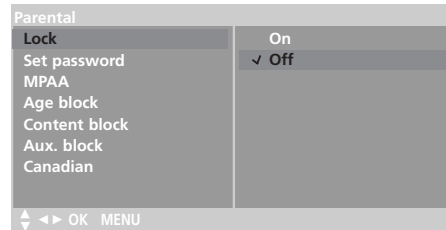
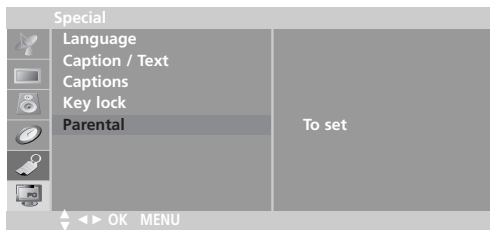

1. Press the **menu** button and then use **▲ / ▼** button to select the **Special** menu.
2. Press the **▶** button and then use **▲ / ▼** button to select **Parental**. Then, press the **▶** button.
 - If **Lock** is already set, enter the password requested.
 - The TV is set with the initial password "0-0-0-0".
2. **Setting Lock on/off:**

Press the **▲ / ▼** button to select **Lock on/off**.
 Press the **▶** button and then use **▲ / ▼** button to select **on** or **off**.
3. **Set password:**

Press the **▲ / ▼** button to select **Set password**.
 Press the **▶** button and then enter a four digit password.
 Enter it again when requested.
4. Press the **▲ / ▼** button to select type of blocking to be set .
5. Press the **▶** button and then use **▲ / ▼** button to select type of ratings to block .
 - **Age block**, and **Content block**, and **Canadian** (option) menus, also have sub menus. So, repeat steps 4 and 5 in the sub menu, to set the types of blocking and ratings.

Maintenance

- Early malfunctions can be prevented. Careful and regular cleaning can extend the amount of time you will have your new TV. Be sure to turn the power off and unplug the power cord before you begin any cleaning.

Cleaning the Screen

1. Here's a great way to keep the dust off your screen for a while. Wet a soft cloth in a mixture of lukewarm water and a little fabric softener or dish washing detergent. Wring the cloth until it's almost dry, and then use it to wipe the screen.
2. Make sure the excess water is off the screen, and then let it air-dry before you turn on your TV.

Cleaning the Cabinet

To remove dirt or dust, wipe the cabinet with a soft, dry, lint-free cloth. Please be sure not to use a wet cloth.

Extended Absence



If you leave your TV dormant for a long time (such as a vacation), it's a good idea to unplug the power cord to protect against possible damage from lightning or power surges.

Product Specifications

MODEL	Z15LA7R	Z20LA7R
Power Requirement	AC100-240V~ 50/60Hz 0.9A	AC100-240V~ 50/60Hz 1.2A
Power Consumption	55W	65W
Audio Output	3 W + 3 W	5 W + 5 W
Television System	NTSC	
Television Channel	VHF : 2 ~ 13, UHF : 14 ~ 69, Cable : 01 ~ 125	
Television Screen	LCD Panel	
External Antenna Impedance	75 Ω	

Troubleshooting Checklist

SYMPTOMS

No power

No picture or sound

Poor picture but good sound

Poor reception

Lines in picture

Ghosts (multiple images)

Remote control does not work.

Cannot tune desired channel.

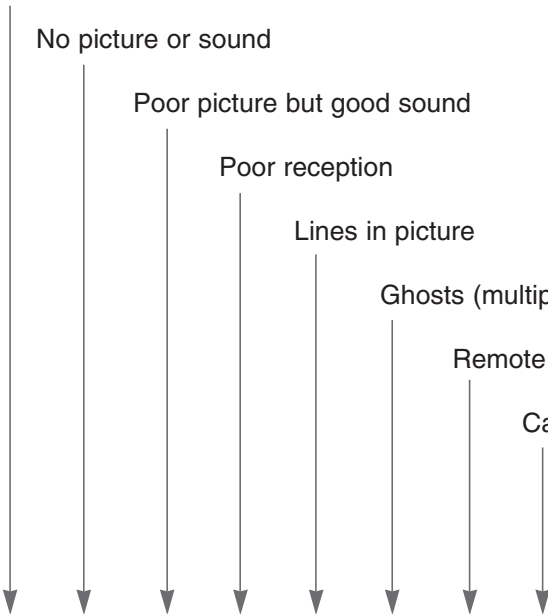
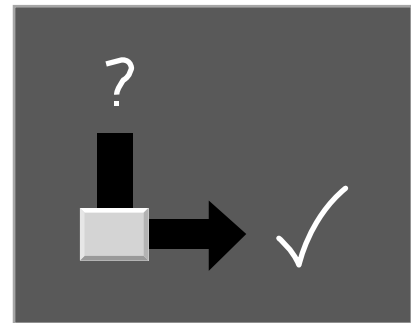

CHECK THESE THINGS

- Is power cord plugged in ?
- Is television turned on ?
- Check batteries in remote control.
- Try another channel (station trouble).
- Check antenna connectings.
- Check for local interference.
- Adjust the antenna.
- Adjust the picture control.
- Program channel using EZ Scan.

ZENITH ELECTRONICS CORPORATION LCD-TV LIMITED WARRANTY – USA



Zenith will repair or replace your product, at Zenith's option, if it proves to be defective in material or workmanship under normal use, during the warranty period ("Warranty Period") listed below, effective from the date ("Date of Purchase") of original purchase of the product. This limited warranty is good only to the original purchaser of the product and effective only when used in the United States, excluding U.S. Territories.

<p>WARRANTY PERIOD:</p> <p>LABOR: 1 Year from the Date of Purchase.</p> <p>PARTS: 1 Year from the Date of Purchase.</p> <p>* Repaired or replaced products are warranted for the remaining portion of the original warranty period.</p>	<p>HOW SERVICE IS HANDLED:</p> <p>Factory Service. Call 1-877-9Zenith (1-877-993-6484) (24 hours a day, 365 days per year) for instructions on getting the defective unit repaired or replaced.</p> <p>Please retain dated sales receipt and your box to return the unit to Zenith for replacement.</p> <p>Shipping charges both ways will be paid by Zenith during the Warranty Period.</p> <p>Visit our website at http://www.zenithservice.com</p>
--	---

THIS WARRANTY IS IN LIEU OF ANY OTHER WARRANTIES, EXPRESS OR IMPLIED, INCLUDING WITHOUT LIMITATION, ANY WARRANTY OF MERCHANTABILITY OR FITNESS FOR A PARTICULAR PURPOSE. TO THE EXTENT ANY IMPLIED WARRANTY IS REQUIRED BY LAW, IT IS LIMITED IN DURATION TO THE EXPRESS WARRANTY PERIOD ABOVE. ZENITH WILL NOT BE LIABLE FOR ANY INCIDENTAL, CONSEQUENTIAL, INDIRECT, SPECIAL, OR PUNITIVE DAMAGES OF ANY NATURE, EVEN IF ADVISED OF THE POSSIBILITY OF SUCH DAMAGES, INCLUDING WITHOUT LIMITATION, LOST REVENUES OR PROFITS, LOST OR CORRUPTED PROGRAMMING OR DATA, OR ANY OTHER DAMAGE WHETHER BASED IN CONTRACT, TORT, OR OTHERWISE.

Some states do not allow the exclusion or limitation of incidental or consequential damages or limitations on how long an implied warranty lasts, so the above exclusion or limitation may not apply to you. This warranty gives you specific legal rights and you may also have other rights that vary from state to state.

THIS LIMITED WARRANTY DOES NOT APPLY TO:

- Damages or operating problems that result from shipping, installation, adjustment of user controls, calibration, maintenance or failure to maintain, or separate system components; and
- Damages or operating problems that result from normal wear and tear, misuse, abuse, operation outside environmental specifications or contrary to the requirements or precautions in the Operating Guide, accident, lightning strikes or other natural causes, unauthorized modification or alteration, incorrect electrical current or voltage, signal reception or input, operating and software protocols adopted after date of manufacture or for outside the US, institutional or commercial use, or other causes not arising out of defect in material or workmanship.

The cost of repair or replacement under these excluded circumstances shall be borne by the consumer.

CUSTOMER INTERACTIVE CENTER NUMBERS:

<p>For Where to buy, Product Assistance, or Customer Assistance</p>	<p>Call 1-877-9Zenith (1-877-993-6484) (24 hours a day, 365 days per year) and select appropriate options from the menu.</p> <p>Or visit our website at http://www.zenithservice.com</p>
--	---

LG Customer Interactive Center
201 James Record Road
Huntsville, Alabama 35824
<http://www.zenithservice.com>

P/NO : 3828TUL293Z(0412-REV00)
Printed in Korea

Free Manuals Download Website

<http://myh66.com>

<http://usermanuals.us>

<http://www.somanuals.com>

<http://www.4manuals.cc>

<http://www.manual-lib.com>

<http://www.404manual.com>

<http://www.luxmanual.com>

<http://aubethermostatmanual.com>

Golf course search by state

<http://golfingnear.com>

Email search by domain

<http://emailbydomain.com>

Auto manuals search

<http://auto.somanuals.com>

TV manuals search

<http://tv.somanuals.com>