



website:<http://us.lgservice.com>



MICROWAVE OVEN

OWNER'S MANUAL & COOKING GUIDE

PLEASE READ THIS OWNER'S MANUAL THOROUGHLY BEFORE OPERATING.

LRM1260SW/LRM1260SB

TABLE OF CONTENTS

SAFETY	3-4
Precautions to Avoid Possible Exposure to Excessive Microwave Energy.....	3
Grounding Instructions.....	3
Important Safety Instructions	4
UNDERSTANDING YOUR MICROWAVE OVEN	5-9
Specifications.....	5
Installation.....	5
Parts and Accessories	6
Control Panel	7
Tips for Microwave Cooking	8
Precautions.....	9
Cleaning.....	9
USING YOUR MICROWAVE OVEN	10-20
Timed Cooking	10
2 Stage Timed Cooking	10
Microwave Power Levels	10
Child Lock	11
Kitchen Timer	11
Ez-On	11
More/Less	11
Custom Set	12
Sensor Touch	13
Auto Cook.....	14
Clock	14
Quick Defrost	14
Melt	15
Soften.....	15
Auto Defrost.....	16-18
HEATING/REHEATING GUIDE	19
FRESH VEGETABLE GUIDE	20
TROUBLESHOOTING	21-23
Questions and Answers	21-22
Before Calling for Service	23
WARRANTY	Inside back cover

Thank you for purchasing a LG microwave oven.

Please record the model number and serial number of this unit for future reference. We also suggest you record the details of your contact with LG (LG Electronics U.S.A., Inc.) concerning this unit.

Staple your receipt here for proof of purchase.

Model No: _____

Serial No: _____

Dealer: _____

Dealer Phone No: _____

Customer Relations
LG Electronics U.S.A., Inc.
Service Division Bldg. #3
201 James Record Rd.
Huntsville, AL 35824-0126

SAFETY

PRECAUTIONS TO AVOID POSSIBLE EXPOSURE TO EXCESSIVE MICROWAVE ENERGY

- **Do not attempt to operate this oven with the door open**, since open-door operation can result in harmful exposure to microwave energy. It is important not to defeat or tamper with the safety interlocks.
- **Do not place any object between the oven front face and the door**, or allow soil or cleaner residue to accumulate on sealing surfaces.
- **Do not operate the oven if it is damaged.** It is particularly important that the oven door closes properly and that there is no damage to the:
 - door (bent),
 - hinges and latches (broken or loosened),
 - door seals and sealing surfaces.
- **The oven should not be adjusted or repaired** by anyone except properly qualified service personnel.

GROUNDING INSTRUCTIONS

This appliance must be grounded. In the event of an electrical short circuit, grounding reduces the risk of electric shock by providing an escape wire for the electric current. This appliance is equipped with a cord having a grounding wire and a grounding plug. The plug must be plugged into an outlet that is properly installed and grounded.

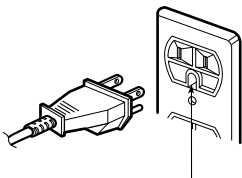

Ensure proper ground exists before use

⚠ WARNING ⚠

Improper grounding can result in a risk of electric shock. Consult a qualified electrician if the grounding instructions are not completely understood, or if doubt exists as to whether the appliance is properly grounded, and either:

1. If it is necessary to use an extension cord, use only a 3-wire extension cord that has a 3-blade grounding plug and a 3-slot receptacle that will accept the plug on the appliance.

The marked rating of the extension cord shall be equal to or greater than the electrical rating of the appliance, or . . .

2. Do not use an extension cord. If the power supply cord is too short, have a qualified electrician or serviceman install an outlet near the appliance.

NOTES:

1. A short power-supply cord is provided to reduce the risks resulting from becoming entangled in or tripping over a longer cord.
2. Longer cord sets or extension cords are available and may be used if care is exercised in their use.
3. If a long cord or extension cord is used, (1) the marked electrical rating of the cord set or extension cord should be at least as great as the electrical rating of the appliance, (2) the extension cord must be a grounding-type 3-wire cord, and (3) the longer cord should be arranged so that it will not drape over the countertop or tabletop where it can be pulled on by children or tripped over accidentally.

SAFETY

IMPORTANT SAFETY INSTRUCTIONS

The safety instructions below will tell you how to use your oven to avoid harm to yourself or damage to your oven.

WARNING - To reduce the risk of burns, electric shock, fire, injury to persons, or exposure to excessive microwave energy:

1. Read all instructions before using the appliance.
2. Read and follow the specific **PRECAUTIONS TO AVOID POSSIBLE EXPOSURE TO EXCESSIVE MICROWAVE ENERGY** found on page 3 of this manual.
3. This appliance must be grounded. Connect only to properly grounded outlet. See **GROUNDING INSTRUCTIONS** found on page 3 of this manual .
4. Install or locate this appliance only in accordance with the provided installation instructions.
5. Some products, such as whole eggs and sealed containers – for example, closed glass jars are able to explode and should not be heated in this oven.
6. Use this appliance only for its intended use as described in the manual. Do not use corrosive chemicals or vapors in this appliance. This type of oven is specifically designed to heat, cook, or dry food. It is not designed for industrial or laboratory use.
7. As with any appliance, close supervision is necessary when used by children.
8. Do not operate this appliance if it has a damaged cord or plug, if it is not working properly, or if it has been damaged or dropped.
9. This appliance should be serviced only by qualified service personnel. Contact the nearest authorized service facility for examination, repair, or adjustment.
10. Do not cover or block any openings on the appliance.
11. Do not store this appliance outdoors. Do not use this product near water – for example, near a kitchen sink, in a wet basement, near a swimming pool, or similar location.
12. Do not immerse cord or plug in water.
13. Keep cord away from heated surfaces.
14. Do not let cord hang over the edge of a table or counter.
15. When cleaning surfaces of door and oven that come together on closing the door, use only mild, nonabrasive soaps or detergents applied with a sponge or soft cloth.
16. To reduce the risk of fire in the oven cavity:
 - a. Do not over cook food. Carefully attend appliance when paper, plastic, or other combustible materials are placed inside the oven to facilitate cooking.
 - b. Remove wire twist-ties from paper or plastic bags before placing bag in oven.
 - c. If materials inside the oven ignite, **KEEP OVEN DOOR CLOSED**, turn oven off, and disconnect the power cord or shut off power at the fuse or circuit breaker panel.
 - d. Do not use the cavity for storage purposes. Do not leave paper products, cooking utensils, or food in the cavity when not in use.
17. Liquids, such as water, coffee, or tea are able to be overheated beyond the boiling point without appearing to be boiling. Visible bubbling or boiling when the container is removed from the microwave oven is not always present. **THIS COULD RESULT IN VERY HOT LIQUIDS SUDDENLY BOILING OVER WHEN THE CONTAINER IS DISTURBED OR A SPOON OR OTHER UTENSIL IS INSERTED INTO THE LIQUID.** To reduce the risk of injury to persons; 1) Do not overheat the liquid. 2) Stir the liquid both before and halfway through heating it. 3) Do not use straight-sided containers with narrow necks. 4) After heating, allow the container to stand in the microwave oven for a short time before removing the container. 5) Use extreme care when inserting a spoon or other utensil into the container.
18. Avoid heating small-necked containers such as syrup bottles.
19. Avoid using corrosive and vapors, such as sulfide and chloride.
20. Liquids heated in certain shaped containers (especially cylindrical-shaped containers) may become overheated. The liquid may splash out with a loud noise during or after heating or when adding ingredients (instant coffee, etc.), resulting in harm to the oven and possible injury. In all containers, for best results, stir the liquid several times before heating. Always stir liquid several times between reheatings.

SAVE THESE INSTRUCTIONS

UNDERSTANDING YOUR MICROWAVE OVEN

SPECIFICATIONS

MODEL	LRM1260SW/LRM1260SB
Power Supply	120 V AC, 60 Hz
Rated Power Consumption	1650 W
Microwave Output	*1200 W
Frequency	2450 MHz
Rated Current	13.8 A
Overall Dimensions(WxHxD)	21 ⁷ / ₈ "x12 ¹ / ₂ "x17 ¹ / ₈ "
Oven Cavity Dimensions(WxHxD)	14 ¹¹ / ₁₆ "x9 ⁵ / ₈ "x15 ⁵ / ₈ "
Effective Capacity of Oven Cavity	1.2 Cu.ft.

*IEC 60705 RATING STANDARD

Specifications subject to change without prior notice.

INSTALLATION

A. Circuits

For safety purposes this oven must be plugged into a 20 Amp circuit. No other electrical appliances or lighting circuits should be on this line. In if doubt, consult a licensed electrician.

B. Voltage Warning

The voltage used at the wall receptacle must be the same as specified on the oven name plate located on the back or on the side of the control panel of the oven. Use of a higher voltage is dangerous and may result in a fire or other type of accident causing oven damage. Low voltage will cause slow cooking. In case your microwave oven does not perform normally in spite of proper voltage, remove and reinsert the plug.

C. Placement of the Oven

Your microwave oven can be placed easily in your kitchen, family room, or anywhere else in your home. Place the oven on a flat surface such as a kitchen countertop or a specially designed microwave oven cart at least 100cm (39.4 inches) from floor. Do not place oven above a gas range. Free air flow around the oven is important. Allow at least 4 inches of space at the top, sides, and back of the oven for proper ventilation.

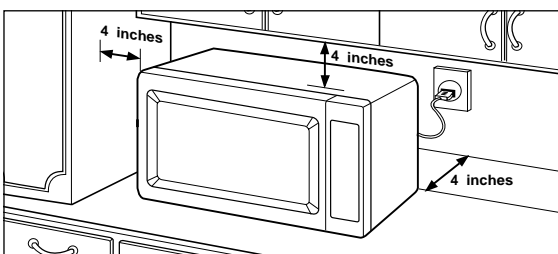

NOTES:

- Never place the turntable in the oven upside down.

D. Do not block the air vents

All air vents should be kept clear during cooking. If air vents are covered during oven operation the oven may overheat. In this case, a sensitive thermal safety device automatically turns the oven off. The oven will be inoperable until it has cooled sufficiently.

E. Radio interference

1. Microwave oven operation may interfere with TV or radio reception.
2. When there is interference, it may be reduced or eliminated by taking the following measures:
 - a. Clean the door and the sealing surfaces of the oven.
 - b. Reorient the receiving antenna of radio or TV.
 - c. Relocate the microwave oven in relation to the TV or radio.
 - d. Move the microwave oven away from the receiver.
 - e. Plug the microwave oven into a different outlet so that microwave oven and receiver are on different branch circuits.

UNDERSTANDING YOUR MICROWAVE OVEN

PARTS AND ACCESSORIES

Your oven comes with the following accessories:

- Owner's Manual and Cooking Guide : 1 each
- Glass Turntable : 1 each
- Rotating Ring : 1 each

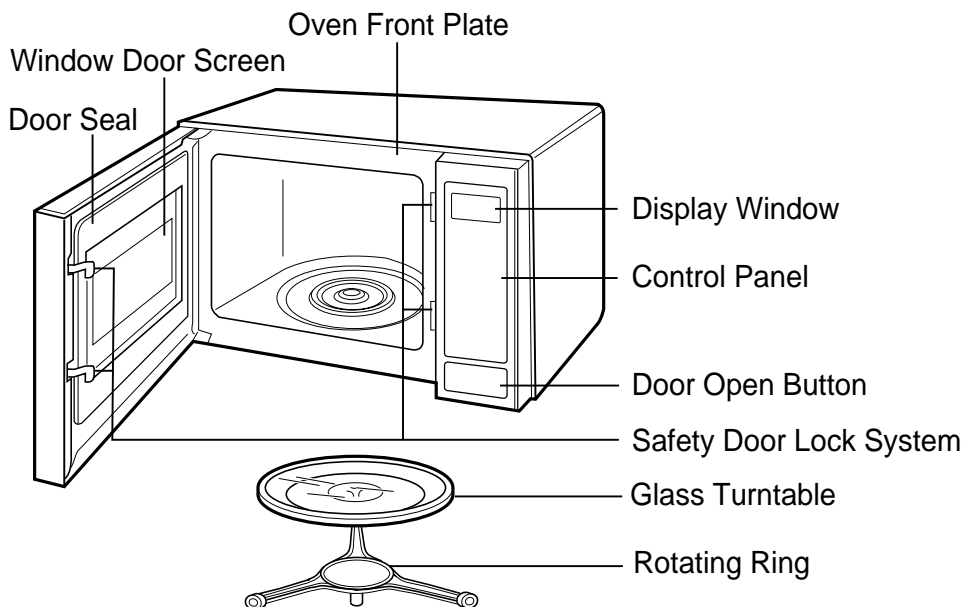

NOTE: This microwave oven is designed for household use only.
It is not recommended for commercial use.

UNDERSTANDING YOUR MICROWAVE OVEN

CONTROL PANEL

- 1. DISPLAY:** The display includes a clock and indicators that tell you the time of day, cook time settings, and cooking functions selected.
- 2. AUTO DEFROST:** Touch this pad to defrost foods by entering weight.
- 3. CUSTOM SET:** Touch this pad to select sound control, time of day, clock Off or On, scroll speed, lbs/kg choice.
- 4. QUICK DEFROST:** Touch this pad to defrost the foods quickly.
- 5. SENSOR TOUCH:** This pad allows you to cook most of your favorite foods without selecting cooking time and power.
- 6. MELT :** Touch this pad to melt chocolate, cheese, butter, or marshmallows.
- 7. SOFTEN :** Touch this pad to soften ice cream, cream cheese, butter, or frozen juice.
- 8. AUTO COOK:** Touch this pad to reheat without entering a cook time or power.
- 9. KITCHEN TIMER:** Touch this pad to use your microwave oven as a kitchen timer.
- 10. TIME:** Touch this pad to set a cook time.
- 11. CLOCK:** Touch this pad to enter the time of the day.
- 12. EZ-ON:** You can extend cooking time in multiples of 30 seconds by repeatedly touching this pad during cooking.
- 13. MORE / LESS :** All of the one touch cook and Timed Cook can be adjusted to cook food for a longer or shorter time.
MORE → Press MORE will add 10 seconds to the cooking time.
LESS → Press LESS will subtract 10 seconds to the cooking time.
- 14. NUMBER PADS :** Touch number pads to enter cook time, power level, quantities, or weights.
- 15. POWER LEVEL :** Touch this pad to set a cook power.
- 16. START/ENTER:** This feature allows oven to begin functioning.
- 17. STOP/CLEAR :** It used to stop oven and clear all entries except time day.

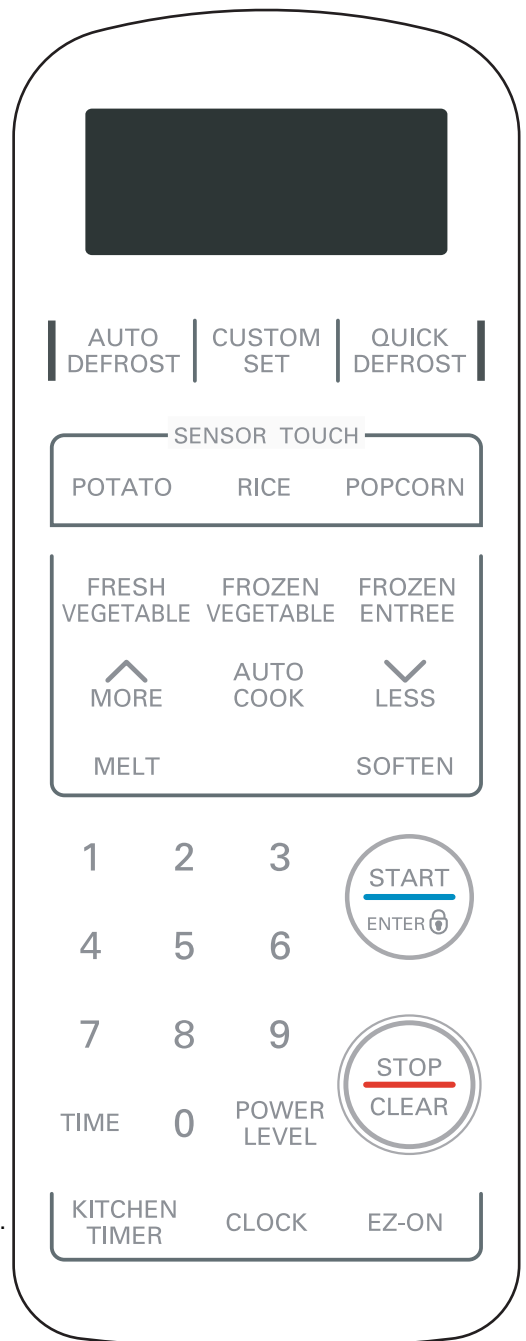

UNDERSTANDING YOUR MICROWAVE OVEN

TIPS FOR MICROWAVE COOKING

BROWNING

Meat and poultry with high fat content cooked for at least 10 to 15 minutes will brown lightly. Foods cooked a shorter time can be brushed with a browning agent, such as Worcestershire sauce, soy sauce, or barbecue sauce.

COVERING

A cover will trap heat and steam and cause the food to cook more quickly. Use a lid or microwave-safe plastic wrap with one corner folded back to vent the excess steam. Lids on glass casseroles can become hot during cooking; always handle carefully. Waxed paper will prevent the food from splattering in the oven and help retain heat. When warming bread items, use waxed paper, napkins, or paper towels. To absorb extra moisture, wrap sandwiches and fatty foods in paper towels.

SPACING

Arrange individual foods, such as baked potatoes, cupcakes, and hors d'oeuvres in a circle and at least 1 inch apart. This will help the food cook more evenly.

STIRRING

Stirring blends flavors and redistributes the heat in foods. Always stir from the outside toward the center of the dish. Food at the outside of the dish heats first.

TURNING

Large foods, such as roasts and whole poultry, should be turned so that the top and bottom cook evenly. Also turn over chicken pieces and chops.

ARRANGEMENT

Do not stack food. Arrange in a single layer in the dish for more even cooking. Because dense foods cook more slowly, place thicker portions of meat, poultry, fish, and vegetables toward the outside of the dish.

TESTING FOR DONENESS

Foods cook quickly in a microwave oven; test frequently for doneness.

STANDING TIME

Food often needs to stand from 2 to 15 minutes after being removed from the oven. Usually, you need to cover food during standing time to retain heat. Remove most foods when they are slightly undercooked and they will finish cooking during standing time. The internal temperature of food will rise about 10°F during standing time.

SHIELDING

To prevent some portions of rectangular or square dishes from overcooking, you may need to shield them with small strips of aluminum foil to block the microwaves. You can also cover poultry legs and wing tips with foil to keep them from overcooking. **Always keep foil at least 1 inch from oven walls** to prevent arcing.

PIERCING

Pierce the shell, skin, or membrane of foods before cooking to prevent them from bursting. Foods that require piercing include yolks and whites of eggs, hot dogs, clams, oysters, and whole vegetables, such as potatoes and squash.

UNDERSTANDING YOUR MICROWAVE OVEN

PRECAUTIONS

- Place the front surface of the door three inches or more from the countertop edge to avoid accidental tipping of the microwave oven during normal use.
- To program the oven, make sure you touch the center of each pad firmly since the areas between the pads will not activate the oven. A tone will sound each time a pad is touched correctly. Do not touch several pads at once.
- Do not strike the control panel with silverware, cookware, etc. Breakage may occur.
- Always use caution when taking cookware out of the oven. Some dishes absorb heat from the cooked food and may be hot. See the "Cookware Guide" earlier in this section for more information.
- Do not rinse cookware immediately after cooking. This may cause breakage. Also, always allow the turntable to cool before removing it from the oven.
- Never operate the oven when it is empty. Food or water should always be in the oven during operation to absorb the microwave energy.
- Do not use the oven to dry newspapers or clothes. They may catch fire.
- Use thermometers that have been approved for microwave oven cooking.
- The turntable must always be in place when you operate the oven.
- Do not use your microwave oven to cook eggs in the shell. Pressure can build up inside the shell, causing it to burst.
- There are several precautions to follow when microwaving popcorn:
 - Do not pop popcorn, except in a microwave-safe container or commercial packages designed for microwave ovens.
 - Never try to pop popcorn in a paper bag that is not microwave-approved.
 - Overcooking may result in smoke and fire.
 - Do not repop unpopped kernels.
 - Do not reuse popcorn bags.
 - Listen while corn pops. Stop oven when popping slows to 2-3 seconds between pops.
 - Do not leave microwave unattended while popping corn.
 - Follow directions on bag.

CLEANING

NOTE: Before cleaning the oven, unplug the power cord. If this is impossible, open the oven door to prevent an accidental oven start.

INTERIOR

Wipe the oven inside and outside with a soft cloth and a mild detergent solution. Then rinse and wipe dry. This should be done weekly or more often, if needed. Never use cleaning powders or rough pads.

Excessive oil splatters on the inside top will be difficult to remove if left for many days. Wipe splatters with a wet paper towel, especially after cooking chicken or bacon.

REMOVABLE PARTS

The turntable and rotating ring are removable. They should be hand-washed in warm (not hot) water with a mild detergent and a soft cloth. Once they are clean, rinse well and dry with a soft cloth. Never use cleaning powders, steel wool, or rough pads.

- The turntable may be cleaned at the sink. Be careful not to chip or scratch the edges as this may cause the turntable to break during use.
- The rotating ring should be cleaned regularly.

DOOR

For best performance and safety, the inner door panel and the oven front frame should be free of food or grease buildup. Wipe often with a mild detergent; then rinse and wipe dry. Never use cleaning powders or rough pads.

After cleaning the control panel, touch CLEAR to clear any entries that might have been entered accidentally while cleaning the panel. Also make sure that the turntable and rotating ring are in the right position.

USING YOUR MICROWAVE OVEN

TIMED COOKING

This function allows you to cook food for a desired time. And in order to give you the best results, there are 10 power level settings in addition to HI-POWER because many food need slower cooking (at less than HI-POWER).

Example: To cook food on 80% Power (Power8) for 5 minutes 30 seconds

1. Touch **STOP/CLEAR**.
2. Touch **TIME**.
ENTER COOKING TIME shows in the display.
3. Enter 5 minutes 30 seconds by touching **[5]**, **[3]**, and **[0]**. *TOUCH START OR POWER* shows in the display.
4. Touch **POWER LEVEL**.
ENTER POWER LEVEL 1 TO 10 shows in the display.
5. Touch **8**. To select power level 80%.
P-80 TOUCH START shows in the display.
6. Touch **START/ENTER**.

When cooking is complete, four short tones will sound. The word *END* shows in the display window. Then the oven shuts itself off.

NOTE:

If you do not select the power level, the oven will operate at power HIGH. To set HI-POWER cooking, skip steps 4 & 5 above.

2 STAGE TIMED COOKING

For Two Stage cooking, repeat timed cooking steps 2 through 5 before touching the

START pad for additional Time and Power program you want to add. Auto Weight Defrost can be programmed before the first stage to defrost first and then cook.

MICROWAVE POWER LEVELS

Your microwave oven is equipped with ten power levels to give you maximum flexibility and control over cooking. The table below will give you some idea of which foods are prepared at each of the various power levels.

*The table below shows the power level settings for your oven.

MICROWAVE POWER LEVEL TABLE

Power Level	Use
10 (High)	*Boiling water. *Making candy. *Cooking poultry pieces, fish, & vegetables. *Cooking tender cuts of meat. *Whole poultry.
9	*Reheating rice, pasta, & vegetables.
8	*Reheating prepared foods quickly. *Reheating sandwiches.
7	*Cooking egg, milk and cheese dishes. *Cooking cakes, breads. *Melting chocolate.
6	*Cooking veal. *Cooking whole fish. *Cooking puddings and custard.
5	*Cooking ham, whole poultry, lamb. *Cooking rib roast, sirloin tip.
4	*Thawing meat, poultry and seafood.
3	*Cooking less tender cuts of meat. *Cooking pork chops, roast.
2	*Taking chill out of fruit. *Softening butter.
1	*Keeping casseroles and main dishes warm. *Softening butter and cream cheese.
0	* Standing time. * Independent.

USING YOUR MICROWAVE OVEN

CHILD LOCK

This is a unique safety feature that prevents unwanted oven operation such as used by children. Once the CHILD LOCK is set, no cooking can take place.

To set the child lock



Touch and hold **START/ENTER** until **LOCKED** appears in the display.
If the time of day was already set, the time of day will return to the display window.
After you touch another

If the CHILD LOCK was already set and you touched another cooking pad, the word **LOCKED** shows in the display.
Then you can cancel the CHILD LOCK according to below procedure.

To cancel the child lock



Touch and hold **START/ENTER** pad until **LOCKED** disappears in the display.

After the CHILD LOCK is turned off, the time of day will return to the display window. The oven will operate normally.

KITCHEN TIMER

You can use the Timer of your oven for purposes other than food cooking.

Example : To set the timer 3 minutes.



1. Touch **STOP/CLEAR**.

KITCHEN
TIMER

2. Touch **KITCHEN TIMER** pad. **ENTER TIME IN MIN AND SEC** shows in the display.

3 0 0

3. Touch **3, 0, 0**. **TOUCH START** shows in the display.



4. Touch **START/ENTER** pad.

Ez-ON

A time-saving pad, this simplified control lets you quickly set and start microwave cooking without the need to touch START.

Example : To set Ez-ON cooking 2 minutes.



1. Touch **STOP/CLEAR**.



Ez-ON

2. Touch **Ez-ON** 4 times.
The oven begins cooking and display shows time counting down.

NOTE:

If you touch **Ez-ON**, it will add 30 seconds up to 3 minutes 30 seconds; after 3 minutes 30 seconds, every touch will add 1 minute up to 99 min 59 seconds.

MORE/LESS

By using the MORE or LESS keys, TIMED COOK program can be adjusted to cook food for a longer or shorter time. Pressing MORE will add 10 seconds to the cooking time each time you press it. Pressing LESS will subtract 10 seconds of cooking time each time you press it.

To adjust the cooking time for a longer time, or for a shorter time.



1. Touch **STOP/CLEAR**.



1 0 0

2. Touch **1, 0, 0**.

1:00

TOUCH START OR

POWER shows on the display



3. Touch **START/ENTER**. then the oven will start.



MORE LESS

4. Touch **MORE** or **LESS**.
Remaining time will increase or decrease by 10 seconds.

USING YOUR MICROWAVE OVEN

CUSTOM SET

CUSTOM SET provides five modes which make using your microwave oven quite handy. You can select SOUND ON/OFF, CLOCK SETTING, CLOCK ON/OFF. SCROLL SPEED, LBS/KG CHOICE.

Example 1 : To turn off Sound of beeper.



1. Touch **STOP/CLEAR**.

↓

CUSTOM SET

↓

1

↓

2

2. Touch **CUSTOM SET**.
Five modes show in the display repeatedly. You can set them according to your intention:

3. Touch **1. SOUND ON TOUCH 1 OFF TOUCH 2** shows in the display.

4. Touch **2. SOUND OFF** shows in the display and the current time will be displayed.

NOTE: To turn beep sound back on, repeat steps 1 - 3 then touch number 1.

Example 2 : To set the units.



1. Touch **STOP/CLEAR**.

↓

CUSTOM SET

↓

4

↓

2

2. Touch **CUSTOM SET**.
Five modes show in the display repeatedly. You can set them according to your intention:

3. Touch **4. LBS TOUCH 1 KG TOUCH 2** shows in the display.

4. Touch **2. KG** shows in the display and the current time will be displayed.

CUSTOM SET FUNCTION TABLE

NUMBER	FUNCTION	CHOICE
1	SOUND ON / OFF	Sound On or Sound Off
2	CLOCK ON / OFF	Clock On or Clock Off
3	SCROLL SPEED	Slow, Normal, or Fast
4	LBS / KG CHOICE	Lbs or Kg

NOTE: 1. When the power cord is first plugged in, the default setting are Sound ON, Clock ON, Normal Speed, LBS.

USING YOUR MICROWAVE OVEN

SENSOR TOUCH

Use this function to cook food without entering a cook time or power. Refer to the Sensor touch table below more information.

Example : Sensor touch (cooking potato)



1. Touch **STOP/CLEAR**.



POTATO

2. Touch **POTATO**.
POTATO
shows in the display.

SENSOR TOUCH TABLE

Category	Direction	Amount
Popcorn	Popcorn lets you pop commercially packaged microwave popcorn. Pop only one package at a time. For best results, use fresh bag of popcorn. Place bag of prepackaged microwave popcorn on the center of turntable.	Regular size. Use one fresh bag of popcorn.
Potato	Pierce each potato with a fork and place on the oven tray around the edge, at least one inch apart. After cooking, allow to stand for 5 minutes.	1, 2, 3 or 4 potatoes Medium size (10 oz. each)
Rice	Place rice and twice as much liquid (water or chicken) in a 2 -quart microwaveable dish. cover with plastic wrap. when cooking is complete, allow 10 minutes standing time. stir rice.	1 ~ 2 cups Use medium or long grain rice.
Frozen Entree	Remove from outer display package. Vent the plastic film by piercing with a fork (3 times) If not in microwave safe container, place on a plate, cover with plastic wrap and vent. After cooking, allow to stand for 3 minutes.	10 ~21oz.
Fresh Vegetable	Prepare as desired, wash and leave residual water on the vegetables. Place in an appropriately sized microwave container. Add amount of water according to the quantity (1~2 cups : 2 tablespoons, 3~4 cups : 4 tablespoons). Cover with plastic wrap and vent. After cooking, stir and allow to stand for 3 minutes.	1, 2, 3 or 4 cups
Frozen Vegetable	Remove from package, rinse off frost under running water. Place in an appropriately sized microwave container. Add amount of water according to the quantity (1~2 cups : 2 tablespoons, 3~4 cups : 4 tablespoons). Cover with plastic wrap and vent. After cooking, stir and allow to stand for 3 minutes.	1, 2, 3 or 4 cups

USING YOUR MICROWAVE OVEN

AUTO COOK

This feature allows to cook foods that you select by touching AUTO COOK pad. It has 6 foods categories.

Example : To cook 4 oz. of Pasta

1. Touch **STOP/CLEAR**.
2. Touch **AUTO COOK**.
*SELECT MENU 1 TO 6 -
-SEE COOKING GUIDE*
shows in the display.
3. Touch number **4**.
PASTA TOUCH 1 TO 2
shows in the display.
4. Touch number **1**, then the oven will start automatically.

AUTO COOK TABLE

• First, touch AUTO COOK pad, then select food and amount.

Category	Direction	Amount
Bacon	Place bacon strips on bacon rack for best results.(use dinner plate lined with paper towels if rack is not available).	2 to 6 slices
Frozen Roll/Muffin	Remove from display package and place on plate.(if muffins are over 3 oz.each. count as two when entering quantity).	1 to 6 pieces (2~3 oz.each)
Fresh Roll/Muffin	Remove from display package and place on plate.(if muffins are over 3 oz.each. count as two when entering quantity).	1 to 6 pieces (2~3 oz.each)
Beverage	Remove from display package and place on plate.(Be careful! The beverage will be very hot! Sometimes liquids heated in cylindrical containers will splash out when the cup is moved)	1 or 2 cups
Chicken Pieces	Place the chicken pieces in an appropriately sized microwavable container.cover with plastic wrap minutes. Stir for fluffier rice.	0.5~2 lbs
Hot Cereal	Prepare as directed on package and cook. Stir and allow standing time before eating. Use only instant hot cereal.	1 to 6 servings

If you open the door or press STOP during cooking, the process will be canceled.

CLOCK

Example : To set the clock for 10:30 (AM)

1. Touch **STOP/CLEAR**.
2. Touch **CLOCK** :
ENTER TIME OF DAY
3. Touch number **1 0 3 0**.
4. Touch **START/ENTER**
*10 : 30 AM TOUCH 1
PM TOUCH 2*
5. Touch number **1**
*AM 10 : 30 TOUCH
START*
6. Touch **START/ENTER**
AM 10 : 30

NOTE: This is a 24 hour clock. You can switch between AM and PM by touching 1 or 2 after step 4.

QUICK DEFROST

Use this function to thaw only 1 lb. of ground meat very quickly.

NOTE: The oven beeps during the defrost cycle. After it beeps, open the door and turn over, separate, or rearrange the food. QUICK DEFROST provides just enough defrosting so that the food can be used in recipes or for cooking. Some ice crystals remain.

Example: Quick Defrost

1. Touch **STOP/CLEAR**.
2. Touch **QUICK DEFROST**.

* Ground beef 1 Lbs only / 0.5 Kg only.

USING YOUR MICROWAVE OVEN

MELT

The oven uses low power to melt foods (butter, chocolate, marshmallows and cheese). See the following table.

Example : To Melt 8 oz. Chocolate.



1. Touch **STOP/CLEAR**.
2. Touch **MELT**.
SELECT MENU 1 TO 4 --- SEE COOKING GUIDE shows in the display.
3. Touch number **2**.
CHOCOLATE TOUCH 1 TO 2 shows in the display.
4. Touch number **2**, then the oven will start automatically.

When the cook time is over, you will hear four beeps and **END** will be displayed.

SOFTEN

The oven uses low power to soften foods (butter, ice cream, cream cheese, and frozen juice) See the following table.

Example : To Soften 8 oz. Cream Cheese.



1. Touch **STOP/CLEAR**.
2. Touch **SOFTEN**.
SELECT MENU 1 TO 4 --- SEE COOKING GUIDE shows in the display.
3. Touch number **3**.
CREAM CHEESE TOUCH 1 TO 2 shows in the display.
4. Touch number **2**, then the oven will start automatically.

When the cook time is over, you will hear four beeps and **END** will be displayed.

MELT TABLE

Category	Direction	Amount
Butter	Unwrap and place in microwavable container. No need to cover butter. Stir at the end of cooking to complete melting.	1, 2 or 3 sticks
Chocolate	Chocolate chips or squares of baking chocolate may be used. Unwrap squares and place in microwavable container. Stir at the end of cycle to complete melting.	4 or 8 oz.
Cheese	Use processed cheese food only. Cut into cubes. Place in a single layer in microwavable container. Stir at the end of cooking to complete melting.	8 or 16 oz.
Marshmallows	Large or miniature marshmallows may be used. Place in microwavable container. Stir at the end of cycle to complete melting.	5 or 10 oz.

SOFTEN TABLE

Category	Direction	Amount
Butter	Unwrap and place in microwavable container. No need to cover butter. Butter will be at room temperature and ready for use in recipe.	1, 2 or 3 sticks
Ice Cream	Place container in oven. Ice cream will be soft enough to make scooping easier.	Pint, Quart, Half gallon
Cream Cheese	Unwrap and place in microwavable container. Cream cheese will be at room temperature and ready for use in recipe.	3 or 8 oz.
Frozen Juice	Remove top. Place in oven. Frozen juice will be soft enough to easily mix with water.	6, 12 or 16 oz.

USING YOUR MICROWAVE OVEN

AUTO DEFROST

Three defrost sequences are preset in the oven. The defrost feature provides you with the best defrosting method for frozen foods. The cooking guide will show you which defrost sequence is recommended for the food you are defrosting. With the Auto Defrost feature, the oven automatically sets the defrosting time and power levels for you.

The oven automatically determines required defrosting times for each food item according to the weight you enter.

For added convenience, the Auto Defrost includes a built-in beep mechanism that reminds you to check, turn over, separate, or rearrange.

1 MEAT

2 POULTRY

3 FISH

* Available weight is 0.1~6.0 lbs.

*For best results, remove fish, shellfish, meat, and poultry from its original closed paper or plastic package (wrapper). Otherwise, the wrap will hold steam and juice close to the foods, which can cause the outer surface of the foods to cook.

*For best results, shape your ground meat into the form of a doughnut before freezing. When defrosting, scrape off thawed meat when the beep sounds and continue defrosting.

*Place foods in a shallow container or on a microwave roasting rack to catch drippings.

*Food should still be somewhat icy in the center when removed from the oven.

AUTO DEFROST SEQUENCE LIST

Sequence	Food
1 MEAT	BEEF Ground beef, Round steak, Cubes for stew, Tenderloin steak, Pot roast, Rib roast, Rump roast, Chuck roast, Hamburger patty. LAMB Chops (1 inch thick), Rolled roast PORK Chops (1/2 inch thick), Hot dogs, Spareribs, Country-style ribs. Rolled roast, Sausage. VEAL Cutlets (1 lbs, 1/2 inch thick)
2 POULTRY	POULTRY Whole (under 4 lbs.), Cut-up, Breasts (boneless) CORNISH HENS Whole TURKEY Breast(under 6 lbs.)
3 FISH	STEAKS/CHOPS Round beef steak, Tenderloin steak Lamb chops (1 inch thick) Pork chops (1/2 inch thick) Veal cutlets (1 lbs, 1/2 inch thick) FISH Fillets, Whole Steaks SHELLFISH Crab meat, Lobster tails, Shrimp, Scallops

Example: To defrost 1.2 lbs of meat

1. Touch **STOP/CLEAR**.
2. Touch **AUTO DEFROST**.
MEAT TOUCH 1
POULTRY TOUCH 2
FISH TOUCH 3
shows in the display
3. Touch **1**. *ENTER WEIGHT* shows in the display.
4. Enter the weight by touching **[1]** and **[2]**.
1.2 LBS TOUCH START shows in the display.
5. Touch **START/ENTER** pad. Defrosting starts.

NOTE:

When you touch the START pad, the display changes to defrost time count down. The oven will beep once during the DEFROST cycle.

At beep, open the door and turn, separate, or rearrange the food.

Remove any portions that have thawed.

Return frozen portions to the oven and touch START to resume the defrost cycle.

USING YOUR MICROWAVE OVEN

AUTO DEFROST TABLE

Meat setting

FOOD	SETTING	AT BEEP	SPECIAL INSTRUCTIONS
BEEF			Meat of irregular shape and large, fatty cuts of meat should have the narrow or fatty areas shielded with foil at the beginning of a defrost sequence.
Ground Beef, Bulk	MEAT	Remove thawed portions with fork. Turn over. Return remainder to oven.	Do not defrost less than 1/4 lb. Freeze in doughnut shape.
Ground Beef, Patties	MEAT	Separate and rearrange.	Do not defrost less than 2 oz. patties. Depress center when freezing.
Round Steak	MEAT	Turn over. Cover warm areas with aluminum foil.	Place on a microwavable roasting rack.
Tenderloin Steak	MEAT	Turn over. Cover warm areas with aluminum foil.	Place on a microwavable roasting rack.
Stew Beef	MEAT	Remove thawed portions with fork. Separate remainder. Return remainder to oven.	Place in a microwavable baking dish.
Pot Roast, Chuck Roast	MEAT	Turn over. Cover warm areas with aluminum foil.	Place on a microwavable roasting rack.
Rib Roast	MEAT	Turn over. Cover warm areas with aluminum foil.	Place on a microwavable roasting rack.
Rolled Rump Roast	MEAT	Turn over. Cover warm areas with aluminum foil.	Place on a microwavable roasting rack.
LAMB			
Cubes for Stew	MEAT	Remove thawed portions with fork. Return remainder to oven.	Place in a microwavable baking dish.
Chops (1 inch thick)	MEAT	Separate and rearrange.	Place on a microwavable roasting rack.
PORK			
Chops (1/2 inch thick)	MEAT	Separate and rearrange.	Place on a microwavable roasting rack.
Hot Dogs	MEAT	Separate and rearrange.	Place on a microwavable roasting rack.
Spareribs Country-style Ribs	MEAT	Turn over. Cover warm areas with aluminum foil.	Place on a microwavable roasting rack.
Sausage, Links	MEAT	Separate and rearrange.	Place on a microwavable roasting rack.
Sausage, Bulk	MEAT	Remove thawed portions with fork. Turn over. Return remainder to oven.	Place in a microwavable baking dish.
Loin Roast, Boneless	MEAT	Turn over. Cover warm areas with aluminum foil.	Place on a microwavable roasting rack.

USING YOUR MICROWAVE OVEN

AUTO DEFROST TABLE (CONT.)

Poultry setting

FOOD	SETTING	AT BEEP	SPECIAL INSTRUCTIONS
CHICKEN Whole	POULTRY	Turn over (finish defrosting breast-side down). Cover warm areas with aluminum foil.	Place chicken breast-side up on a microwavable roasting rack. Finish defrosting by immersing in cold water. Remove giblets when chicken is partially defrosted.
Cut-up		Separate pieces and rearrange. Turn over. Cover warm areas with aluminum foil.	Place on a microwavable roasting rack. Finish defrosting by immersing in cold water.
CORNISH HENS Whole	POULTRY	Turn over. Cover warm areas with aluminum foil.	Place on a microwavable roasting rack. Finish defrosting by immersing in cold water.
TURKEY Breast	POULTRY	Turn over. Cover warm areas with aluminum foil.	Place on a microwavable roasting rack. Finish defrosting by immersing in cold water.

Fish setting

FOOD	SETTING	AT BEEP	SPECIAL INSTRUCTIONS
FISH Fillets	FISH	Turn over. Separate fillets when partially thawed if possible.	Place in a microwavable baking dish. Carefully separate fillets under cold water.
Steaks	FISH	Separate and rearrange.	Place in a microwavable baking dish. Run cold water over to finish defrosting.
Whole	FISH	Turn over.	Place in a microwavable baking dish. Cover head and tail with foil; do not let foil touch sides of microwave. Finish defrosting by immersing in cold water.
SHELLFISH Crabmeat	FISH	Break apart. Turn over.	Place in a microwavable baking dish.
Lobster tails	FISH	Turn over and rearrange.	Place in a microwavable baking dish.
Shrimp	FISH	Separate and rearrange.	Place in a microwavable baking dish.
Scallops	FISH	Separate and rearrange.	Place in a microwavable baking dish.

HEATING/REHEATING GUIDE

To heat or reheat successfully in a microwave oven, it is important to follow several guidelines. Measure the amount of food in order to determine the time needed to reheat. Arrange the food in a circular pattern for best results. Room temperature food will heat faster than refrigerated food. Canned foods should be taken out of the can and placed in a microwave-safe container. The food will heat more evenly if covered with a microwave-safe lid or vented plastic wrap. Remove cover carefully to prevent steam burns. Use the following table as a guide for reheating cooked food.

ITEMS	COOK TIME (AT HIGH)	SPECIAL INSTRUCTIONS
Sliced meat 3 slices (1/4-inch thick)	1/2-1 minute	Place sliced meat on microwavable plate. Cover with plastic wrap and vent. Note: Gravy or sauce helps to keep meat juicy.
Chicken pieces 1 breast 1 leg and thigh	1-2 minutes 1/2-1 1/2 minutes	Place chicken pieces on microwavable plate. Cover with plastic wrap and vent.
Fish fillet (6-8 oz.)	1-2 minutes	Place fish on microwavable plate. Cover with plastic wrap and vent.
Lasagna 1 serving (10 1/2 oz.)	3-5 minutes	Place lasagna on microwavable plate. Cover with plastic wrap and vent.
Casserole 1 cup 4 cups	2-3 minutes 7-9 minutes	COOK covered in microwavable casserole. Stir once halfway through cooking.
Casserole – cream or cheese 1 cup 4 cups	2-3 minutes 6-8 minutes	COOK covered in microwavable casserole. Stir once halfway through cooking.
Sloppy Joe or Barbecued Beef 1 sandwich (1/2 cup meat filling) without bun	1/2-1 1/2 minutes	Reheat filling and bun separately. Cook filling covered in microwavable casserole. Stir once. Heat bun as directed in table below.
Mashed potatoes 1 cup 4 cups	1-3 minutes 5-8 minutes	COOK covered in microwavable casserole. Stir once halfway through cooking.
Baked beans 1 cup	1-2 minutes	COOK covered in microwavable casserole. Stir once halfway through cooking.
Ravioli or pasta in sauce 1 cup 4 cups	1-3 minutes 5-7 minutes	COOK covered in microwavable casserole. Stir once halfway through cooking.
Rice 1 cup 4 cups	1/2-1 minute 2-4 minutes	COOK covered in microwavable casserole. Stir once halfway through cooking.
Sandwich roll or bun 1 roll	10-20 seconds	Wrap in paper towel and place on glass microwavable rack
Vegetables 1 cup 4 cups	1-2 minutes 2-4 minutes	COOK covered in microwavable casserole. Stir once halfway through cooking.
Soup 1 serving (8 oz.)	1-2 minutes	COOK covered in microwavable casserole. Stir once halfway through cooking.

FRESH VEGETABLE GUIDE

Vegetable	Amount	Cook Time at High (Minute)	Instructions	Standing Time
Artichokes (8 oz. each)	2 medium 4 medium	2-4 3-5	Trim. Add 2 tsp water and 2 tsp juice. Cover.	2-3 minutes
Asparagus, Fresh, Spears	1 lb.	3-4	Add 1/2 cup water. Cover.	2-3 minutes
Beans, Green & Wax	1 lb.	4-6	Add 1/2 cup water in 1 1/2 qt. casserole. Stir halfway through cooking.	2-3 minutes
Beets, Fresh	1 lb.	4-7	Add 1/2 cup water in 1 1/2 qt. covered casserole. Rearrange halfway through cooking.	2-3 minutes
Broccoli, Fresh, Spears	1 lb.	3-4	Place broccoli in baking dish. Add 1/2 cup water.	2-3 minutes
Cabbage, Fresh, Chopped	1 lb.	3-4	Add 1/2 cup water in 1 1/2 qt. covered casserole. Stir halfway through cooking.	2-3 minutes
Carrots, Fresh, Sliced	2 cups	2-3	Add 1/4 cup water in 1 qt. covered casserole. Stir halfway through cooking.	2-3 minutes
Cauliflower, Fresh, Whole	1 lb.	3-5	Trim. Add 1/4 cup water in 1 qt. covered casserole. Stir halfway through cooking.	2-3 minutes
Flowerettes, Fresh	2 cups	2-3	Slice. Add 1/2 cup water in 1 1/2 qt. covered casserole.	2-3 minutes
Celery, Fresh, Sliced	4 cups	3-4	Stir halfway through cooking.	2-3 minutes
Corn, Fresh	2 ears	2-3	Husk. Add 2 tbsp water in 1 1/2 qt. baking dish. Cover.	2-3 minutes
Mushrooms, Fresh, Sliced	1/2 lb.	1 1/2-2	Place mushrooms in 1 1/2 qt. covered casserole. Stir halfway through cooking.	2-3 minutes
Parsnips, Fresh, Sliced	1 lb.	2-4	Add 1/2 cup water in 1 1/2 qt. covered casserole. Stir halfway through cooking.	2-3 minutes
Peas, Green, Fresh	4 cups	3-5	Add 1/2 cup water in 1 1/2 qt. covered casserole. Stir halfway through cooking.	2-3 minutes
Sweet Potatoes Whole Baking (6-8 oz. each)	2 medium 4 medium	5-6 10-13	Pierce potatoes several times with fork. Place on 2 paper towels. Turn over halfway through cooking.	2-3 minutes 2-3 minutes
White Potatoes, Whole Baking (6-8 oz. each)	2 potatoes 4 potatoes	5-7 10-13	Pierce potatoes several times with fork. Place on 2 paper towels. Turn over halfway through cooking.	2-3 minutes 2-3 minutes
Spinach, Fresh, Leaf	1 lb.	2-4	Add 1/2 cup water in 2 qt. covered casserole.	2-3 minutes
Squash, Acorn or Butternut, Fresh	1 medium	3-5	Cut squash in half. Remove seeds. Place in 8 x 8-inch baking dish. Cover.	2-3 minutes
Zucchini, Fresh, Sliced	1 lb.	3-4	Add 1/2 cup water in 1 1/2 qt. covered casserole. Stir halfway through cooking.	2-3 minutes
Zucchini, Fresh, Whole	1 lb.	3-5	Pierce. Place on 2 paper towels. Turn over and rearrange halfway through cooking.	2-3 minutes

TROUBLESHOOTING

Questions and Answers

Operation

Question	Answer
Why is the oven light not on during cooking?	There may be several reasons why the oven light is not on. Have you: <ul style="list-style-type: none">• Set a cook time?• Touched START?
Why does steam come out of the air exhaust vent?	Steam is normally produced during cooking. The microwave oven has been designed to vent this steam.
Will the microwave oven be damaged if it operates empty?	Yes. Never operate the oven empty or without the glass turntable.
Does microwave energy pass through the viewing screen in the door?	No. The metal screen bounces the energy back to the oven cavity. The holes (or ports) allow only light to pass through. They do not let microwave energy pass through.
Why does a tone sound when a pad on the control panel is touched?	The tone tells you that the setting has been entered.
Can my microwave oven be damaged if food is cooked for too long?	Like any other cooking appliance, it is possible to overcook food to the point that the food creates smoke and even possibly fire and damage to the inside of the oven. It is always best to be near the oven while you are cooking.
When the oven is plugged into wall outlet for the first time, it might not work properly. What is wrong?	The microcomputer controlling your oven may temporarily become scrambled and fail to function as programmed when you plug in for the first time or when power resumes after a power interruption. Unplug the oven from the 120-volt household outlet and then plug it back in to reset the microcomputer.
Why do I see light reflection around the outer case?	This light is from the oven light which is located between the oven cavity and the outer wall of the oven.
What are the various sounds I hear when the microwave oven is operating?	The clicking sound is caused by a mechanical switch turning the microwave oven's magnetron ON and OFF. The heavy hum and clunk is from the change in power the magnetron draws as it is turned ON and OFF by a mechanical switch. The change in blower speed is from the change in line voltage caused by the magnetron being turned ON and OFF.

Food

Question	Answer
What is wrong when baked foods have a hard, dry, brown spot?	A hard, dry, brown spot indicates overcooking. Shorten the cooking or reheating time.
Why do eggs sometimes pop?	When baking, frying, or poaching eggs, the yolk may pop due to steam build-up inside the yolk membrane. To prevent this, simply pierce the yolk before cooking. CAUTION: Never microwave eggs in the shell.

TROUBLESHOOTING

Questions and Answers (continued)

Food

Question	Answer
Why are scrambled eggs sometimes a little dry after cooking?	Eggs will dry out when they are overcooked, even if the same recipe is used each time. The cooking time may need to be varied for one of these reasons: <ul style="list-style-type: none"> • Eggs vary in size. • Eggs are at room temperature one time and at refrigerator temperature another time. • Eggs continue cooking during standing time.
Is it possible to pop popcorn in a microwave oven?	Yes, if using one of the two methods described below: (1) microwave-popping devices designed specifically for microwave cooking (2) prepackaged commercial microwave popcorn that is made for specific times and power output needed Follow exact directions given by each manufacturer for its popcorn popping product and do not leave the oven unattended while the corn is being popped. If corn fails to pop after the suggested time, discontinue cooking. Overcooking could result in an oven fire. CAUTION: <ul style="list-style-type: none"> • Never use a brown paper bag for popping corn or attempt to pop leftover kernels. • Do not pop prepackaged commercial microwave popcorn directly on the glass turntable. To avoid excessive heating of the glass turntable, place the popcorn bag on a plate. • Listen while corn pops. Stop oven when popping slows to 2-3 seconds between pops. • Do not leave microwave unattended while popping corn. • Follow directions on bag.
Why do baked apples sometimes burst during cooking?	The peel has not been removed from the top half of each apple to allow for expansion of the interior of the apple during cooking. As in conventional cooking methods, the interior of the apple expands during the cooking process.
Why do baked potatoes sometimes burn during cooking?	If the cooking time is too long, fire could result. At the end of the recommended cooking time, potatoes should be slightly firm. CAUTION: Do not overcook.
Why is a standing time recommended after microwave cooking time is over?	Standing time allows foods to continue cooking evenly for a few minutes after the actual microwave oven cooking cycle. The amount of standing time depends upon the density of the foods.
Why is additional time required for cooking food stored in the refrigerator?	As in conventional cooking, the initial temperature of food affects total cooking time. You need more time to cook food taken out of a refrigerator than for food at room temperature.

TROUBLESHOOTING

Before Calling for Service

You can often correct operating problems yourself. If your microwave oven fails to work properly, locate the operating problem in the list below and try the solutions listed for each problem.

If the microwave oven still does not work properly, contact the nearest LG Authorized Service Center. LG Authorized Service Centers are fully equipped to handle your service requirements.

Problem	Possible Causes
Oven does not start	<ul style="list-style-type: none">• Is the power cord plugged in?• Is the door closed?• Is the cooking time set?
Arcing or Sparking	<ul style="list-style-type: none">• Are you using approved cookware?• Is the oven empty?
Incorrect time of day	<ul style="list-style-type: none">• Have you tried to reset the time of day?
Unevenly Cooked Foods	<ul style="list-style-type: none">• Are you using approved cookware?• Is the glass turntable in the oven?• Did you turn or stir the food while it was cooking?• Were the foods completely defrosted?• Was the time/cooking power level correct?
Overcooked Foods	<ul style="list-style-type: none">• Was the time/cooking power level correct?
Undercooked Foods	<ul style="list-style-type: none">• Are you using approved cookware?• Were the foods completely defrosted?• Was the time/cooking power level correct?• Are the ventilation ports clear?
Improper Defrosting	<ul style="list-style-type: none">• Are you using approved cookware?• Was the time/cooking power level correct?• Did you turn or stir the food during the defrosting cycle?

FEDERAL COMMUNICATIONS COMMISSION RADIO FREQUENCY INTERFERENCE STATEMENT

WARNING:

This equipment generates and uses ISM frequency energy and if not installed and used properly, that is in strict accordance with the manufacturer's instructions, may cause interference to radio and television reception. It has been type tested and found to comply with limits for ISM Equipment pursuant to part 18 of FCC Rules, which are designed to provide reasonable protection against such interference in a residential installation.

However, there is no guarantee that interference will not occur in a particular installation. If this equipment does cause interference to radio or television reception, which can be determined by turning the equipment off and on, the user is encouraged to try to correct the interference by one or more of the following:

- Reorient the receiving antenna of the radio or television.
- Relocate the microwave oven with respect to the receiver.
- Move the microwave oven away from the receiver.
- Plug the microwave oven into a different outlet so that the microwave oven and the receiver are on different branch circuits.

The manufacturer is not responsible for any radio or TV interference caused by **unauthorized modification** to this microwave oven. It is the responsibility of the user to correct such interference.



LG MICROWAVE OVEN LIMITED WARRANTY — USA

Model LRM1260SW/SB

LG Electronics, Inc. will repair or replace your product, at LG's option, if it proves to be defective in material or workmanship under normal use, during the warranty period set forth below, effective from the date of original consumer purchase of the product. This warranty is good only to the original purchaser of the product and effective only when used in the United States, including U.S. Territories.

<p><u>WARRANTY PERIOD:</u> One Year from the Date of Purchase.</p>	<p><u>HOW SERVICE IS HANDLED:</u></p> <p><u>Product Replacement</u></p> <p>Please call 1-800-243-0000 and choose the <i>Customer Service/Appliance</i> options. (Phones are answered 24 hours a day, 365 days per year.) You will receive a certificate to purchase a replacement product from your local dealer.</p> <p>You will then send the purchase receipts for the original and the replacement microwave ovens, along with the purchase authorization certificate to us.</p> <p>We will send you a refund check for the purchase price of the original product. This gives you the opportunity to upgrade to another model or to receive the full purchase price of the original model even if you decide to purchase a less expensive model.</p> <p>Please visit our website at: http://us.lgservice.com</p>
--	--

THIS WARRANTY IS IN LIEU OF ANY OTHER WARRANTY, EXPRESS OR IMPLIED, INCLUDING WITHOUT LIMITATION, ANY WARRANTY OF MERCHANTABILITY OR FITNESS FOR A PARTICULAR PURPOSE. TO THE EXTENT ANY IMPLIED WARRANTY IS REQUIRED BY LAW, IT IS LIMITED IN DURATION TO THE EXPRESS WARRANTY PERIOD ABOVE. LG WILL NOT BE LIABLE FOR ANY INCIDENTAL, CONSEQUENTIAL, INDIRECT, SPECIAL, OR PUNITIVE DAMAGES OF ANY NATURE, INCLUDING WITHOUT LIMITATION, LOST REVENUES OR PROFITS, OR ANY OTHER DAMAGE WHETHER BASED IN CONTRACT, TORT, OR OTHERWISE. Some states do not allow the exclusion or limitation of incidental or consequential damages or limitations on how long an implied warranty lasts, so the above exclusion or limitation may not apply to you. This warranty gives you specific legal rights and you may also have other rights that vary from state to state.

THIS LIMITED WARRANTY DOES NOT APPLY TO:

- Service trips to your home to deliver, pick up, and/or install the product, instruct, or replace house fuses or correct wiring, or correction of unauthorized repairs.
- Damages or operating problems that result from misuse, abuse, operation outside environmental specifications or contrary to the requirements of precautions in the Operating Guide, accident, vermin, fire, flood, improper installation, acts of God, unauthorized modification or alteration, incorrect electrical current or voltage, or commercial use, or use for other than intended purpose.

The cost of repair or replacement under these excluded circumstances shall be borne by the consumer.

CUSTOMER INTERACTIVE CENTER NUMBERS

<p>To obtain Customer Assistance, Product Information, or Dealer or Authorized Service Center location:</p>	<p>Call 1-800-243-0000 (24 hours a day, 365 days per year) and select the appropriate option from the menu. Or visit our website at: http://us.lgservice.com</p>
--	--

TO CONTACT LG ELECTRONICS BY MAIL:

LG Customer Interactive Center
P. O. Box 240007
201 James Record Road
Huntsville, Alabama 35824
ATTN: CIC



LG Electronics Inc.

P/NO.: MFL30128601

Printed in China

Free Manuals Download Website

<http://myh66.com>

<http://usermanuals.us>

<http://www.somanuals.com>

<http://www.4manuals.cc>

<http://www.manual-lib.com>

<http://www.404manual.com>

<http://www.luxmanual.com>

<http://aubethermostatmanual.com>

Golf course search by state

<http://golfingnear.com>

Email search by domain

<http://emailbydomain.com>

Auto manuals search

<http://auto.somanuals.com>

TV manuals search

<http://tv.somanuals.com>