



MICROWAVE/GRILL/CONVECTION OVEN

OWNER'S MANUAL

CAUTION

PLEASE READ THIS OWNER'S MANUAL THOROUGHLY BEFORE OPERATING.
THE MANUFACTURERS ARE NOT LIABLE FOR ANY PROBLEMS CAUSED BY
THE USER'S FAILURE TO OBSERVE THESE INSTRUCTIONS.

MC8088HL
MC8088HR

P/No: MFL55318502

Contents

How the Microwave Function Works

Microwaves are a form of energy similar to radio, television waves, and ordinary daylight. Normally, microwaves spread outwards as they travel through the atmosphere and disappear without effect. This oven, however, has a magnetron that is designed to make use of the energy in microwaves. Electricity, supplied to the magnetron tube, is used to create microwave energy.

These microwaves enter the cooking area through openings inside the oven. A tray is located inside the oven. Microwaves cannot pass through metal walls of the oven, but they can penetrate such materials as glass, porcelain and paper, the materials out of which microwave-safe cooking dishes are constructed.

Microwaves do not heat cookware, though cooking vessels will eventually get hot from the heat generated by the food.

A very safe appliance

Your Microwave oven, is one of the safest of all home appliances. When the door is opened, the oven automatically stops producing microwaves. Microwave energy is converted completely to heat when it enters food, leaving no "left over" energy to harm you when you eat your food.

Contents	2
Important safety instructions	3 ~ 7
Precautions	8
Unpacking & Installing	9 ~ 10
Control Panel	11
Method to use accessories as per mode	12
Setting the Clock	13
Child Lock	14
Micro Power Cooking	15
Micro Power Level	16
Grill Cooking	17
Grill Combi Cooking	18
Convection Preheat	19
Convection Cooking	20
Convection Combi Cooking	21
Quick Start	22
More or less Cooking	23
Keep Warming	24
Auto Cook	25 ~ 27
Auto Roast	28 ~ 29
Crisp Cook	30 ~ 32
Auto Defrost	33 ~ 34
Combi Defrost	35 ~ 36
Quick Defrost	37 ~ 38
Ez Clean	39
Test dishes in accordance With EN 60705	40
Microwave - safe Utensils	41
Food characteristics & Microwave Cooking	42 ~ 43
Questions & Answers	44
Technical Specifications	45
Maff Reheating Cooked Chilled Foods	46
Guarantee	47

Important Safety Instructions

Please keep for future reference. Read and follow all instructions before using your oven to prevent the risk of fire, electric shock, personal injury, or damage when using the oven. This guide does not cover all possible conditions that may occur. Always contact your service agent or manufacturer about problems that you do not understand.



This is the safety alert symbol. This symbol alerts you to potential hazards that can kill or hurt you and others. All safety messages will follow the safety alert symbol and either the word "WARNING" or "CAUTION". These words mean:



WARNING This symbol will alert you to hazards or unsafe practices which could cause serious bodily harm or death.



CAUTION This symbol will alert you to hazards or unsafe practices which could cause bodily injury or property damage.



WARNING

- Do not attempt to tamper with, or make any adjustments or repairs to the door, door seals, control panel, safety interlock switches or any other part of the oven which would involve the removal of any cover protecting against exposure to microwave energy. Do not operate the oven if the door seals and adjacent parts of the microwave oven are faulty. Repairs should only be undertaken by a qualified service technician.**
 - Unlike other appliances, the microwave oven is a high-voltage and a high-electrical-current piece of equipment. Improper use or repair could result in harmful exposure to excessive microwave energy or in electric shock.
- Do not use the oven for the purpose of dehumidification. (ex. Operating the microwave oven with wet newspapers, clothes, toys, electric devices, pet or child etc.)**
 - It can be the cause of serious damage to safety such as a fire, a burn or a sudden death due to an electric shock.
- The appliance is not intended for use by young children or elderly persons. Only allow children to use the oven without supervision when adequate instructions have been given so that the child is able to use the oven in a safe way and understands the hazards of improper use.**

- Improper use may cause damage such as a fire, electric shock or burn.
- Accessible parts may become hot during use. Young children should be kept away.**
 - They may get a burn.
 - Liquids or other foods must not be heated in sealed containers since they are liable to explode. Remove the plastic wrapping from food before cooking or defrosting. Note though that in some cases food should be covered with plastic film, for heating or cooking.**
 - They could burst.
 - Be certain to use proper accessories on each operation mode, refer to the guide page 12.**
 - Improper use could result in damage to your oven and accessories, or could make spark and a fire.
 - The children should not allow to play with accessories or hang down from the door handle.**
 - They may get hurt.

Important Safety Instructions

Please keep for future reference. Read and follow all instructions before using your oven to prevent the risk of fire, electric shock, personal injury, or damage when using the oven. This guide does not cover all possible conditions that may occur. Always contact your service agent or manufacturer about problems that you do not understand.

CAUTION

- 1. You cannot operate your oven with the door open due to the safety interlocks built into the door mechanism. It is important not to tamper with the safety interlocks.**
 - ⦿ It could result in harmful exposure to excessive microwave energy. (Safety interlocks automatically switch off any cooking activity when the door is opened.)
- 2. Do not place any object (such as kitchen towels, napkins, etc.) between the oven front face and the door or allow food or cleaner residue to accumulate on sealing surfaces.**
 - ⦿ It could result in harmful exposure to excessive microwave energy.
- 3. Do not operate your oven if it is damaged. It is particularly important that the oven door closes properly and that there is no damage to the: (1) door(bent), (2) hinges and latches (broken or loosened), (3) door seals and sealing surfaces.**
 - ⦿ It could result in harmful exposure to excessive microwave energy.
- 4. Please ensure cooking times are correctly set, Small amounts of food require shorter cooking or heating time.**
 - ⦿ Over cooking may result in the food catching on fire and subsequent damage to your oven.
- 5. When heating liquids, e.g. soups, sauces and beverages in your microwave oven,**
 - * Avoid using straight sided containers with narrow necks.
 - * Do not overheat.
 - * Stir the liquid before placing the container in the oven and again halfway through the heating time.
 - * After heating, let it stand in the oven for a short time; stir or shake it again carefully and check the temperature of it before consuming to avoid burns (especially, contents of feeding bottles and baby food jars).
 - ⦿ Be careful when handling the container. Microwave heating of beverages can result in delayed eruptive boiling without evidence of bubbling. This could result in hot liquids suddenly boiling over.
- 6. An exhaust outlet is located on the top, bottom or side of the oven. Don't block the outlet.**
 - ⦿ It could result in damage to your oven and poor cooking results.
- 7. Do not operate the oven when empty. It is best to leave a glass of water in the oven when not in use. The water will safely absorb all microwave energy, if the oven is accidentally started.**
 - ⦿ Improper use could result in damage to your oven.
- 8. Do not cook food wrapped in paper towels, unless your cook book contains instructions for the food you are cooking. And do not use newspaper in place of paper towels for cooking.**
 - ⦿ Improper use can cause an explosion or a fire.

Please keep for future reference. Read and follow all instructions before using your oven to prevent the risk of fire, electric shock, personal injury, or damage when using the oven. This guide does not cover all possible conditions that may occur. Always contact your service agent or manufacturer about problems that you do not understand.

Important Safety Instructions

CAUTION

9. Do not use wooden containers and ceramic containers that have metallic (e.g. gold or silver) inlays. Always remove metal twist ties. Check that the utensils are suitable for use in microwave ovens before use.

- ⦿ They may heat-up and char. Metal objects in particular may arc in the oven, which can cause serious damage.

10. Do not use recycled paper products.

- ⦿ They may contain impurities which may cause sparks and/or fires when used in cooking.

11. Do not rinse the tray and rack by placing it in water just after cooking. This may cause breakage or damage.

- ⦿ Improper use could result in damage to your oven.

12. Be certain to place the oven so the front of the door is 8 cm or more behind the edge of the surface on which it is placed, to avoid accidental tipping of the appliance.

- ⦿ Improper use could result in bodily injury and oven damage.

13. Before cooking, pierce the skin of potatoes, apples or any such fruit or vegetable.

- ⦿ They could burst.

14. Do not cook eggs in their shell. Eggs in their shell and whole hard-boiled eggs should not be heated in microwave ovens since they may explode, even after microwave heating has ended.

- ⦿ Pressure will build up inside the egg which will burst.

15. Do not attempt deep fat frying in your oven.

- ⦿ This could result in a sudden boil over of the hot liquid.

16. If smoke is observed, switch off or disconnect the oven from the power supply and keep the oven door closed in order to stifle any flames.

- ⦿ It can cause serious damage such as a fire or electric shock.

17. When food is heated or cooked in disposable containers made of plastic, paper or other combustible materials, keep an eye on the oven and check it frequently.

- ⦿ Your food may be poured due to the possibility of container deterioration, which also can cause a fire.

18. The temperature of accessible surfaces may be high when the appliance is operating. Do not touch the oven door, outer cabinet, rear cabinet, oven cavity, accessories and dishes during grill mode, convection mode and auto cook operations, before clearing make sure they are not hot.

- ⦿ As they will become hot, there is the danger of a burn unless wearing thick culinary gloves .

Important Safety Instructions

Please keep for future reference. Read and follow all instructions before using your oven to prevent the risk of fire, electric shock, personal injury, or damage when using the oven. This guide does not cover all possible conditions that may occur. Always contact your service agent or manufacturer about problems that you do not understand.

CAUTION

19. **The oven should be cleaned regularly and any food deposits should be removed.**
 - ⦿ Failure to maintain the oven in a clean condition could lead to deterioration of the surface. This could adversely affect the life of the appliance and possibly result in a hazardous situation.
20. **Only use the temperature probe recommended for this oven.**
 - ⦿ You can not ascertain that the temperature is accurate with an unsuitable temperature probe.
21. **If there are heating elements, the appliance becomes hot during use. Care should be taken to avoid touching the heating elements inside the oven.**
 - ⦿ There is danger of a burn.
22. **Follow exact directions given by each manufacturer for their popcorn product. Do not leave the oven unattended while the corn is being popped. If corn fails to pop after the suggested times, discontinue cooking. Never use a brown paper bag for popping corn. Never attempt to pop leftover kernels.**
 - ⦿ Overcooking could result in the corn catching a fire.

23. This appliance must be earthed.

The wires in the mains lead are colored in accordance with the following codes

BLUE ~ Neutral

BROWN ~ Live

GREEN & YELLOW ~ Earth

As the colours of the wires in the mains lead of this appliance may not correspond with the coloured markings identifying the terminals in your plug proceed as follows:

The wire which is colored **BLUE** must be connected to the terminal which is marked with the letter **N** or Colored **BLACK**.

The wire which is colored **BROWN** must be connected to the terminal which is marked with the letter **L** or colored **RED**.

The wire which is colored **GREEN & YELLOW** or **GREEN** must be connected to the terminal which is marked with the letter **E** or \perp .

If the supply cord is damaged, it must be replaced by the manufacturer, a service agent or a similarly qualified person in order to avoid potential hazards.

- ⦿ Improper use may cause serious electric damage.

Important Safety Instructions

Please keep for future reference. Read and follow all instructions before using your oven to prevent the risk of fire, electric shock, personal injury, or damage when using the oven. This guide does not cover all possible conditions that may occur. Always contact your service agent or manufacturer about problems that you do not understand.

CAUTION

24. Do not use harsh abrasive cleaners or sharp metal scrapers to clean the oven door glass.

- ⦿ They can scratch the surface, which may result in the glass shattering.

25. This oven should not be used for commercial catering purposes.

- ⦿ Improper use could result in damage to your oven.

26. If the supplied flexible mains cord of this appliance is damaged, it must be replaced using the special mains cord part number: 6411W1A017S
This appliance is supplied with BS 1363 approved 13 Amp fused mains plug. When replacing the fuse always use a 13 Amp BS 1362 approved type. Never use this plug with the fuse cover omitted. To obtain a replacement fuse cover contact your supplying dealer or LG Electronics U.K. LTD.

If the mains sockets in your home differ, or are not suitable for the type of plug supplied then the plug should be removed and a suitable type fitted.

If the mains plug becomes severed from the mains lead it must be destroyed. A mains plug with bared wires is hazardous if engaged in a mains output line socket.

If a 13 Amp BS 1363 plug is not suitable or any other type of plug used, then this appliance must be protected by a 13 Amp fuse.

- ⦿ Improper use may cause serious damage of safety such as a fire, an electric shock.

27. The microwave oven must be operated with the decorative door open.

- ⦿ If the door is closed while operating, the airflow will get worse possibly resulting in a fire or damage to your oven and the cabinet.

28. The connection may be achieved by having the plug accessible or by incorporating a switch in the fixed wiring in accordance with the wiring rules.

- ⦿ Using improper plug or switch can cause an electric shock or a fire.

Precautions

Precautions for avoiding possible exposure to excessive microwave energy.

You cannot operate your oven with the door open due to the safety interlocks built into the door mechanism. These safety interlocks automatically switch off any cooking activity when the door is opened; which in the operation of microwave function could result in harmful exposure to microwave energy.

It is important not to tamper with the safety interlocks.

Do not place any object between the oven front face and the door or allow food or cleaner residue to accumulate on sealing surfaces.

Do not operate your oven if it is damaged. It is particularly important that the oven door closes properly and that there is no damage to the: (1) door(bent), (2) hinges and latches (broken or loosened), (3) door seals and sealing surfaces.

Your oven should not be adjusted or repaired by anyone except qualified service personnel.

WARNING

Please ensure cooking times are correctly set as over cooking may result in the FOOD catching fire and subsequent damage to your oven.

When heating liquids, e.g. soups, sauces and beverages in your oven with microwave function, delayed eruptive boiling can occur without evidence of bubbling. This could result in hot liquids suddenly boiling over. To prevent this possibility the following steps should be taken:

- 1 Avoid using straight - sided containers with narrow necks.
- 2 Do not overheat.
- 3 Stir the liquid before placing the container in the oven and again halfway through the heating time.
- 4 After heating, let it stand in the oven for a short time; stir or shake it (especially the contents of feeding bottles and baby food jars) again carefully and check the temperature of it before consuming to avoid burns (especially, contents of feeding bottles and baby food jars).
Be careful when handling the container.

WARNING

Always allow food to stand after being cooked by microwaves. Check the temperature of the food before consumption. Especially contents of feeding bottles and baby food jars.

Unpacking & Installing

By following the basic steps on these two pages you will be able to quickly check that your oven is operating correctly. Please pay particular attention to the guidelines on where to install your oven. When unpacking your oven make sure you remove all accessories and packing materials. Check to make sure that your oven has not been damaged during shipping.

1 Unpack your oven and place it on a flat level surface.

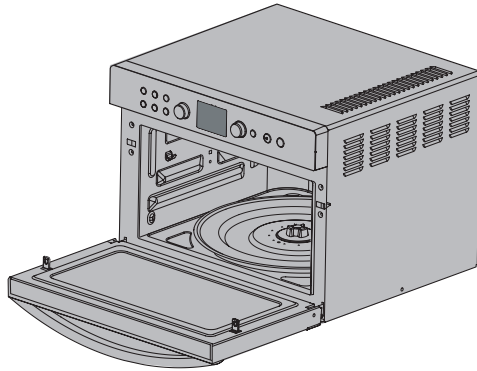

Square tray



Crisp tray



Glass tray
Rotating ring



Square rack



Low rack



High rack

2 Place the oven on the level location of your choice with more than 85cm height but make sure there is at least 20cm of space on the top and 10cm at the rear for proper ventilation. The front of the oven should be at least 8cm from the edge of the surface to prevent tipping. An exhaust outlet is located on bottom or side of the oven. Blocking the outlet can damage the oven.

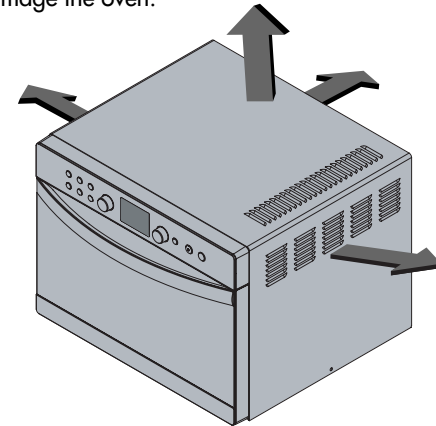

*** THIS OVEN SHOULD NOT BE USED FOR COMMERCIAL CATERING PURPOSES.**

*** THIS OVEN CAN BE USED AS BUILT-IN TYPE .**

*** MUST USE THE BUILT-IN KIT THAT IS MADE BY LG ELECTRONICS.**

3 Plug your oven into a standard household socket. Make sure your oven is the only appliance connected to the socket. **If your oven does not operate properly, unplug it from the electrical socket and then plug it back in.**

4 Open your oven door by pulling the **DOOR HANDLE**. Place the **ROTATING RING** inside the oven and place the **GLASSTRAY** on top.

5 Fill a **microwave safe container** with 300 ml (1/2 pint) of water. Place on the **GLASSTRAY** and close the oven door. If you have any doubts about what type of container to use please refer to Page 41.

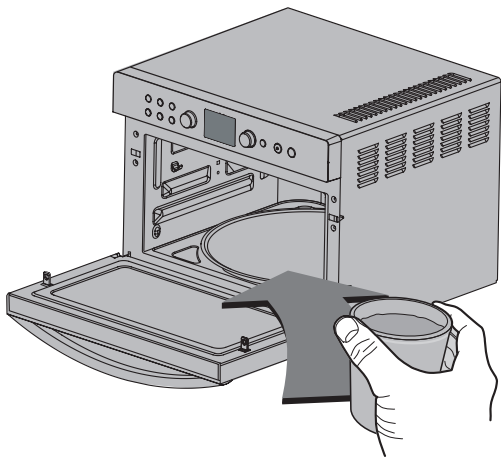

6 Press the **Stop/Clear** button, and press the **Start/Quick Start** button one time to set 30 seconds of cooking time.



7 The **DISPLAY** will count down from 30 seconds. When it reaches 0 it will sound **BEEPS**. Open the oven door and test the temperature of the water. If your oven is operating the water should be warm. **Be careful when removing the container it may be hot.**



YOUR OVEN IS NOW INSTALLED

8 The contents of feeding bottles and baby food jars shall be stirred or shaken and the temperature checked before consumption in order to avoid burns.

Control Panel

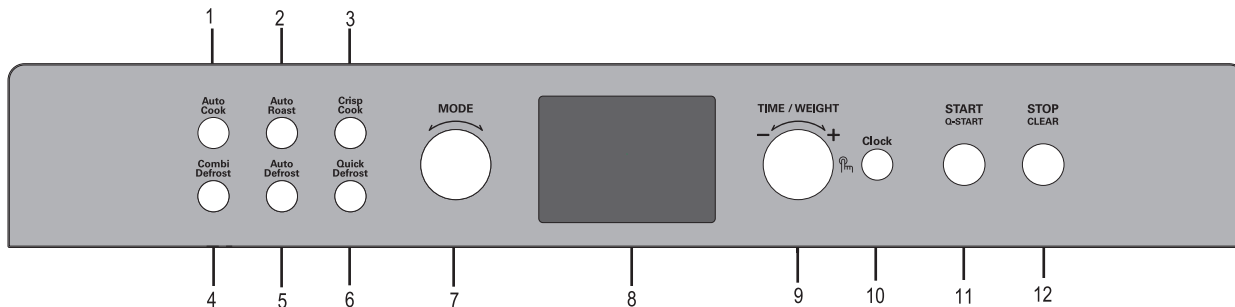

- 1. Auto Cook :** Auto cook allows you to cook your favorite foods by selecting the food type and the weight of the food.
- 2. Auto Roast :** You can select the food type and the weight of the food.
- 3. Crisp Cook :** You can select the food type and the weight of the food.
- 4. Combi Defrost :** You can select the food type and the weight of the food.
- 5. Auto Defrost :** You can select the food type and the weight of the food.
- 6. Quick Defrost :** You can select the food type and the weight of the food.
- 7. MODE :** You can select cooking and function categories.
- 8. Display Window :** You can show time of day, cooking time, temperature, power level and cooking categories.

9. TIME/WEIGHT

- You can determine the selected cooking category.
- You can set cooking times, temperature, power level and weight.
- While cooking with auto and manual function, you can increase or decrease the cooking time at any point by turning the dial (except defrost mode).

10. Clock :





11. START/QUICK START

- In order to start selected cooking, press button one time.
- The quick start feature allows you to set 30 second intervals of HIGH power cooking with a touch of the quick start button.

12. STOP/CLEAR :

You can stop and clear all entries except time of day.

Method to use accessories as per mode

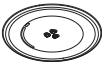
		Microwave	Grill	Convection	Grill combi	Conv combi	Auto Roast	Crisp cook
Square tray		—	—	○	—	○	—	—
Square rack		—	—	○	—	—	—	—
Crisp tray		○	○	—	○	○	○	○
High rack		—	○	○	○	○	—	○
Low rack		—	○	○	○	○	○	○
Glass tray		○	○	○	○	○	○	○

Caution : Use accessories in accordance with cooking guides!

○ : Acceptable

— : Not Acceptable

Setting the Clock

You can set either 12 hour clock or 24 hour clock.

In the following example I will show you how to set the time for 10:30 when using the 24 clock.

Make sure that you have removed all packaging from your oven.



When your oven is plugged in for the first time or when power resumes after a power cut, a '0' will be shown in the display; you will have to reset the clock.

If the clock (or display) shows any strange looking symbols, unplug your oven from the electrical socket and plug it back in and reset the clock.

Make sure that you have correctly installed your oven as described earlier in this book.

Press **STOP/CLEAR**.

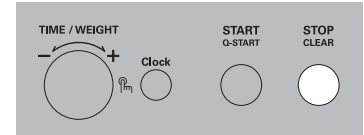

Press **Clock** once.

(If you want to use a 12 hour clock, Turn **TIME/WEIGHT**.

Press **TIME/WEIGHT** for confirmation.

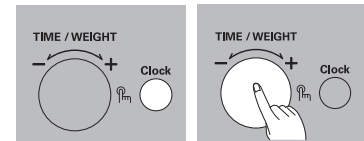

Turn **TIME/WEIGHT** until display shows "10:00".

Press **TIME/WEIGHT** for hour confirmation

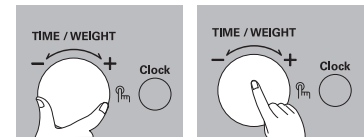

Turn **TIME/WEIGHT** until display shows "10:30".

Press **TIME/WEIGHT**.

The clock starts counting.

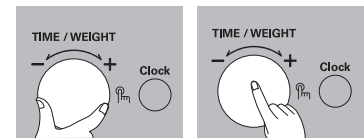

Child Lock

In the following example I will show you how to set the child lock.



Your oven has a safety feature that prevents accidental running of the oven. Once the child lock is set, you will be unable to use any functions and no cooking can take place. However your child can still open the oven door.

Press **STOP/CLEAR**.

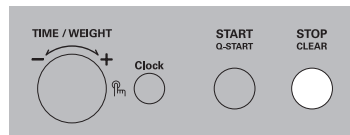

Press and hold **STOP/CLEAR** until "L" appears on the display and BEEP sounds.

The **CHILD LOCK** is now set.

The time will disappear on the display
If any button is pressed, "L" will appear on the display.

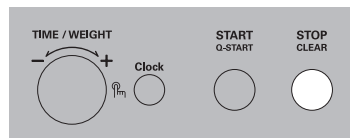

To cancel **CHILD LOCK** press and hold **STOP/CLEAR** until "L" and disappears.

You will hear BEEP when it's unlocked.

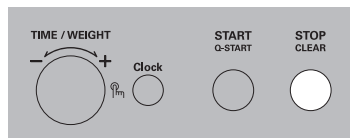

Micro Power Cooking

In the following example I will show you how to cook some food on 400W power for 5 minutes.



Your oven has five microwave Power settings. High power is automatically selected and turning of **TIME/WEIGHT** will select a different power level.

Food to be cooked should be placed in a Microwave-safe utensils.

Please do not use the following accessories.



High rack



Low rack



Square rack



Square tray

Make sure that you have correctly installed your oven as described earlier in this book.

Press **STOP/CLEAR**.

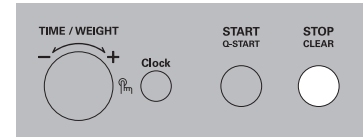

Turn **MODE** to select **Microwave**.

The following indication is displayed: "☰"

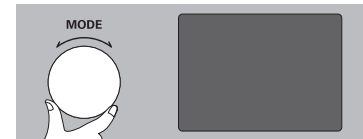

Turn **TIME/WEIGHT** until display shows "400W".

Press **TIME/WEIGHT** for power confirmation.

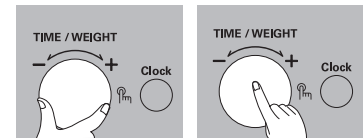

Turn **TIME/WEIGHT** until display shows "5:00".

Press **START/QUICK START**.

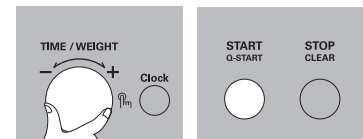

Micro Power Level

This oven is equipped with 5 power levels to give you maximum flexibility and control over cooking.
The table below shows some examples of food and their recommended cooking power levels for use with this oven.



POWER LEVEL	OUTPUT	USE	ACCESSORY
HIGH	1000 W	<ul style="list-style-type: none"> * Boil Water * Brown minced beef * Cook poultry pieces, fish, vegetables * Cook tender cuts meat 	Microwave-safe plate
MEDIUM HIGH	800 W	<ul style="list-style-type: none"> * All reheating * Roast meat and poultry * Cook mushrooms and shellfish * Cook foods containing cheese and eggs 	
MEDIUM	600 W	<ul style="list-style-type: none"> * Bake cakes and scones * Prepare eggs * Cook custard * Prepare rice, soup 	
DEFROST/ MEDIUM LOW	400 W	<ul style="list-style-type: none"> * All thawing * Melt butter and chocolate * Cook less tender cuts of meat 	
LOW	200W	<ul style="list-style-type: none"> * Soften butter & cheese * Soften ice cream * Raise yeast-based dough 	

Grill Cooking

In the following example I will show you how to use the Grill to cook some food for 12 minutes.



This feature will allow you to brown and crisp food quickly.

For the best result use the following accessories.



High rack



High rack
+
crisp tray

Please do not use the following accessories.



Square rack



Square tray

Press **STOP/CLEAR**.

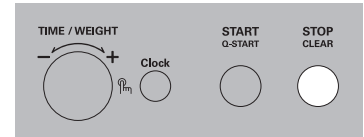

Turn **MODE** to select **Grill**.

The following indication is displayed: "☐"

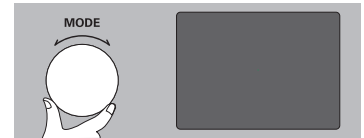

Turn **TIME/WEIGHT** until display shows "12:00".

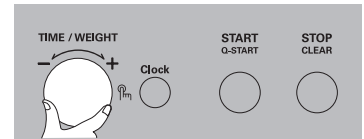

Press **START/QUICK START**.

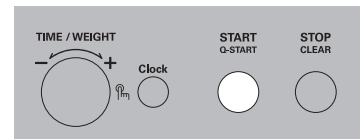

Always use culinary gloves when removing the food and accessories after cooking as the oven & accessories will be very hot.

Grill Combi Cooking

In the following example I will show you how to programme your oven with micro power 400W and grill for a cooking time of 25 minutes.



Your oven has a combination cooking feature that allows you to cook food with both **heater** and **microwave**. This generally means it takes less time to cook your food.

You can set three kinds of micro power levels (200W, 400W, and 600W) in grill combi mode.

For the best result use the following accessories.



High rack



High rack + Crisp tray

Please do not use the following accessories.

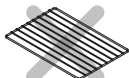

Square rack



Square tray

Press **STOP/CLEAR**.

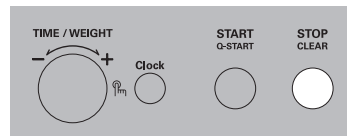

Turn **MODE** to select **Grill Combi**.

The following indications are displayed: "☐☐☐", "☐☐☐".

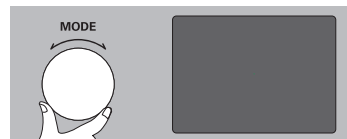

Turn **TIME/WEIGHT** until display shows "400W".

Press **TIME/WEIGHT** for power confirmation.

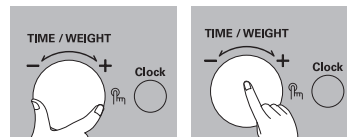

Turn **TIME/WEIGHT** until display shows "25:00".

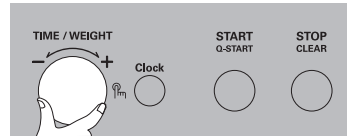

Press **START/QUICK START**.

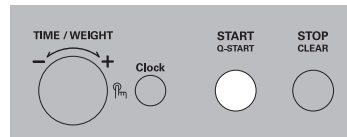

Always use culinary gloves when removing the food and accessories after cooking as the oven & accessories will be very hot.

Convection Preheat

In the following example I will show you how to preheat the oven to a temperature of 200°C.



The convection oven has a temperature range of 40°C and 100°C ~ 230°C (180°C is automatically available when convection mode is selected).

The oven has a ferment function at the oven temperature of 40°C. You may wait until the oven is cool because you cannot use a ferment function if the oven temperature is over 40°C.

Your oven will take a few minutes to reach the selected temperature.

Once it has reached correct temperature, your oven will BEEP to let you know that it has reached the correct temperature.

Then place your food in your oven and tell your oven to start cooking.

Press **STOP/CLEAR**.

1

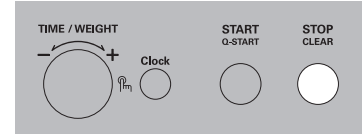

Turn **MODE** to select **Conv**.

The following indication is displayed: "👤"

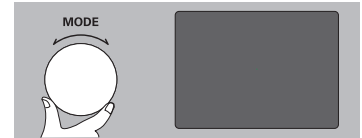

Turn **TIME/WEIGHT** until display shows "200°C".

3

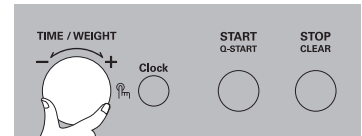

Press **START/QUICK START**.

Preheating will be started with displaying "Pr-H".

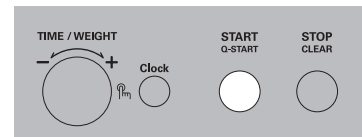

Convection Cooking

In the following example, I will show you how to cook some food at a temperature of 230°C for 50 minutes.

If you do not set a temperature your oven will automatically select 180 °C, the cooking temperature can be changed by turning **TIME/WEIGHT**.

FOR TWO LEVEL COOKING

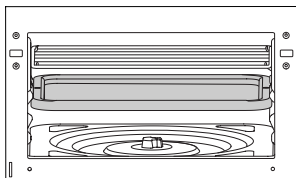

1. When cooking on two levels use both the shelves supplied, with the square tray on the lower level and the square rack on the upper level.
2. When cooking on two levels, remove other accessories(glass tray, rotating).

FOR ONE LEVEL COOKING

For the best result, please use the following accessories.



Low rack



Square tray

Press **STOP/CLEAR**.

The metal tray or metal rack must be used during convection cooking.

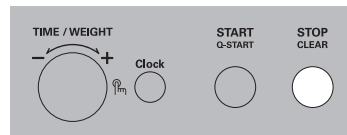

Turn **MODE** to select **Conv.**

The following indication is displayed: "🌀"

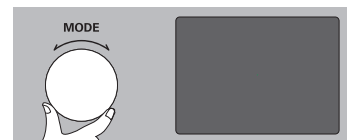

Turn **TIME/WEIGHT** until display shows "230°C".

Press **TIME/WEIGHT** for temperature confirmation.

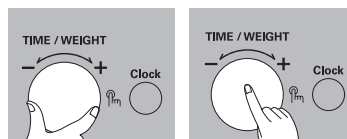

Turn **TIME/WEIGHT** until display shows "50:00".

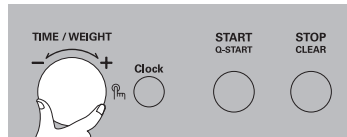

Press **START/QUICK START**.

Always use culinary gloves when removing the food and accessories after cooking as the oven & accessories will be very hot.

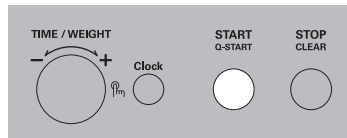

Convection combi

Cooking

In the following example I will show you how to programme your oven with micro power 300W and at a convection temperature 200°C for a cooking time of 25 minutes.



You can set three kinds of micro power levels (200W, 300W and 400W).

For the best result, use the following accessories.

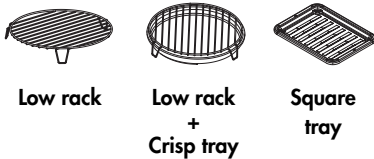

Please do not use the following accessories.

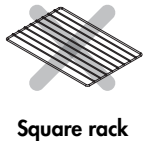

Press **STOP/CLEAR**.

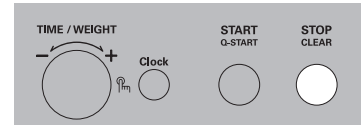

Turn **MODE** to select **Conv. Combi**.

The following indications are displayed: "≡", "☼".

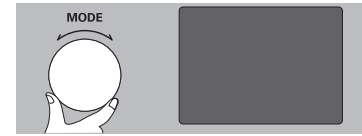

Turn **TIME/WEIGHT** until display shows "300W".

Press **TIME/WEIGHT** for power confirmation.

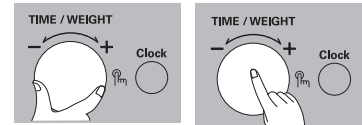

Turn **TIME/WEIGHT** until display shows "200°C".

Press **TIME/WEIGHT** for temperature confirmation.

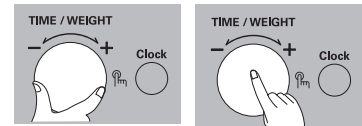

Turn **TIME/WEIGHT** until display shows "25:00".

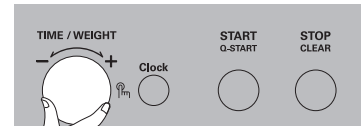

Press **START/QUICK START**.

Always use culinary gloves when removing the food and accessories after cooking as the oven & accessories will be very hot.



Quick Start

In the following example I will show you how to set 2 minutes of cooking on high power (1000W).



The **Quick Start** feature allows you to set 30 second intervals of HIGH power (1000W) cooking by pressing the **Start/Quick Start** button.

Food to be cooked should be placed in a Microwave-safe utensils.

Please do not use the following accessories.



High rack



Low rack

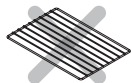

Square rack



Square tray

Press **STOP/CLEAR**.

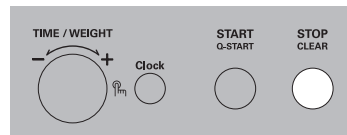

Press **START/QUICK START** four times to select 2 minutes on HIGH power (1000W).

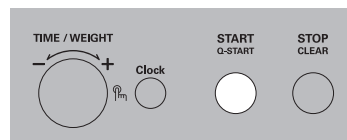

Your oven will start before you have finished the fourth press.

More or Less Cooking

In the following example I will show you how to change the preset COOK programmes for a longer or shorter cooking time.



If you find that your food is over or undercooked when using the preset COOK programme, you can increase or decrease cooking time by turning the **TIME/WEIGHT**.

You can lengthen or shorten the cooking time(except defrost mode) at any point by turning the **TIME/WEIGHT**.

Press **STOP/CLEAR**.

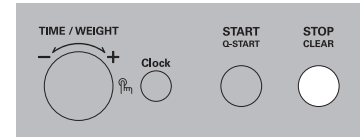

Set the required preset **COOK** programme.

Select weight of food.

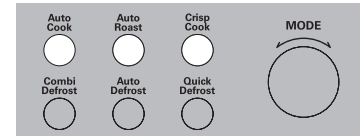

Press **START/QUICK START**.

Turn **TIME/WEIGHT**.



The cooking time will increase or decrease.

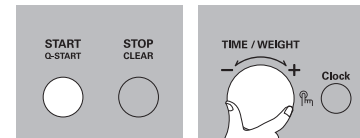

Keep Warming

In the following example I will show you how to keep warming at the temperature of 90°C for 30 minutes.



The oven has a temperature range of 30°C ~ 90°C, when keep warming is selected.

When you press keep warming, 60°C is set initially.

Your oven will take a few minutes to reach the selected temperature.

Once it has reached the correct temperature, your oven will BEEP.

Press **STOP/CLEAR**.

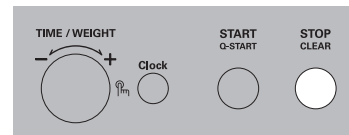

Turn **MODE** until display shows "60°C".

The following indication is displayed: "60°C"

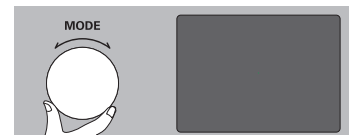

Turn **TIME/WEIGHT** until display shows "90°C".

Press **TIME/WEIGHT** for temperature confirmation.

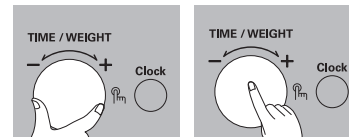

Turn **TIME/WEIGHT** until display shows "30:00".

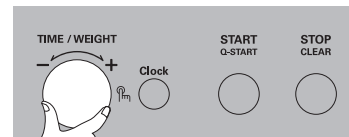

Press **START/QUICK START**.

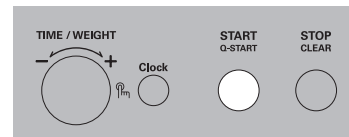

Auto Cook

In the following example I will show you how to cook 0.6 kg of frozen vegetables.



Auto cook menus are programmed. Auto cook allows you to cook most of your favorite food by selecting the food type and the weight of the food.

Press **STOP/CLEAR**.

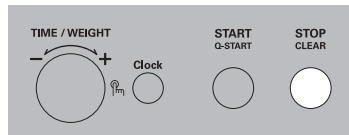

Press **Auto cook**.

The following indication is displayed: "  "

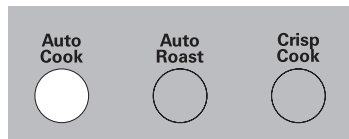

Turn **TIME/WEIGHT** until display shows "Ac 3".

Press **TIME/WEIGHT** for category confirmation.

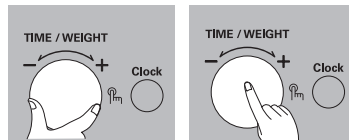

Turn **TIME/WEIGHT** until display shows "0.6kg".

Press **START/QUICK START**.



When cooking you can increase or decrease cooking time by turning **TIME/WEIGHT**.

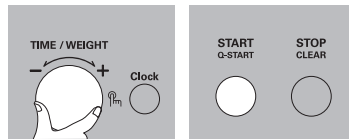

AUTO COOK GUIDE

Function	Category		Weight Limit	Utensil	Food Temp.	Instructions															
Auto cook	AC 1	Jacket Potatoes	0.2~1.0 kg	High Rack 	Room	Choose medium sized potatoes 180-220g. Wash and dry potatoes. Pierce potatoes several times with a fork. Place potatoes on the rack. Adjust weight and press start. When beep sounds, turn food over. After cooking, cover with aluminum foil, let stand for 5 minutes.															
	AC 2	Fresh Vegetables	0.2~0.8 kg	Microwave-safe bowl	Room	Place vegetables in a microwave-safe bowl. Add the amount of water according to the quantity. ** 0.2kg -0.4kg : 2 tablespoons ** 0.2kg -0.4kg : 4 tablespoons Cover with plastic wrap. Place food in the oven. After cooking, stir for 3-4 second. Cover and let stand for 3 minutes.															
	AC 3	Frozen Vegetables	0.2~0.8 kg	Microwave-safe bowl	Frozen	Place vegetables in a microwave - safe bowl. Add the amount of water according to the quantity. ** 0.2kg -0.4kg : 2 tablespoons ** 0.2kg -0.4kg : 4 tablespoons Cover with plastic wrap. Place food in the oven. After cooking, stir for 3-4 seconds. Cover and let stand 3 minutes.															
	AC 4	Rice/Pasta	0.1~0.3 kg	Microwave-safe bowl	Room	Place rice/pasta and boiling water with 1/4 to 1 teaspoon salt in a large, deep bowl (3L). <table border="1" data-bbox="852 815 1485 908"> <thead> <tr> <th>Weight</th> <th>100g</th> <th>200g</th> <th>300g</th> <th>Cover</th> </tr> </thead> <tbody> <tr> <td rowspan="2">Water</td> <td>Rice</td> <td>250ml</td> <td>500ml</td> <td>750ml</td> <td>Cover and vent with wrap</td> </tr> <tr> <td>Pasta</td> <td>400ml</td> <td>800ml</td> <td>1200ml</td> <td>Uncover</td> </tr> </tbody> </table> ** Rice - After cooking, Cover and let stand for 5 minutes or until water is absorbed. ** Pasta - During the cooking, stir several times if required. After cooking, let stand 1-2 minutes. Rinse pasta with cold water.	Weight	100g	200g	300g	Cover	Water	Rice	250ml	500ml	750ml	Cover and vent with wrap	Pasta	400ml	800ml	1200ml
Weight	100g	200g	300g	Cover																	
Water	Rice	250ml	500ml	750ml	Cover and vent with wrap																
	Pasta	400ml	800ml	1200ml	Uncover																

AUTO COOK GUIDE

Function	Category		Weight Limit	Utensil	Food Temp.	Instructions
Auto cook	AC 5	Cake	0.5~1.0 kg	Heat-proof glass cake pan on low rack	Room	Carefully follow the sponge cake recipe below. Place the cake pan in the oven on the low rack.
	AC 6	Chilled ready meal	0.3~0.6 kg	Own tray	Refrigerated	Pierce using a skewer on the film. Place food on the glasstray. After cooking, stand for 2 minutes. - Stirrable e.g : Spaghetti bolognese, Beel stew - Non-stirrable e.g : Lasagne, Cottage pie Note: For food contained in bag(s), pierce meat portion and rice/pasta portions several times. - For stirrable foods, stir if needed.
	AC 7	Frozen ready meal	0.3~0.6 kg	Own tray	Frozen	Place frozen ready meals uncovered on the glass tray.
	AC 8	Soup/Sauce	0.2~0.8 kg	Microwave-safe bowl	Room	Pour the soup/sauce into a microwave-safe bowl. Cover with plastic wrap. Place food in the oven. After cooking, stir and cover before letting it stand for 3 minutes. stir again.

* AC 5 Sponge cake recipe (0.5kg)

Ingredients	Recipe
170g flour 170g sugar 100ml water 125g eggs 50g melted butter 10g baking powder	<ol style="list-style-type: none"> Mix the eggs and the sugar in a bowl for 2~3minutes on max power. Add melted butter, flour, baking powder and water. Mix well with spatula. Grease and line the base of heat-proof glass cake pan with greaseproof paper. Spoon in the cake mixture and smooth the surface.

Auto Roast

In the following example I will show you how to cook 1.4 kg of roast beef.



Auto Roast cook allows you to cook most of your favorite food easily by selecting the food type and entering the weight of the food.

For the best result, use the following accessories.



Low rack + Crisp tray

CAUTION:

Always use culinary gloves when removing the food and accessories after cooking as the oven & accessories will be very hot.

Press **STOP/CLEAR**.

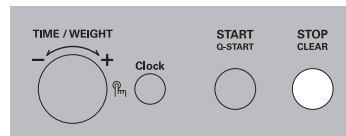

Press **Auto Roast**.

The following indication is displayed: "Auto"

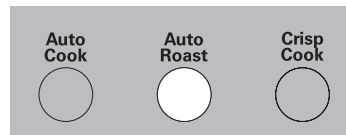

Turn **TIME/WEIGHT** until display shows "Ar 1".

Press **TIME/WEIGHT** for category confirmation.

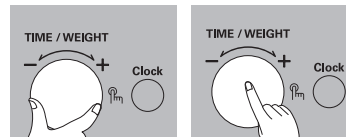

Turn **TIME/WEIGHT** until display shows "1.4kg".

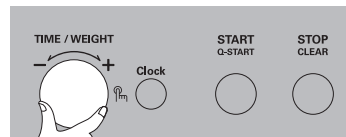

Press **START/QUICK START**.

When cooking you can increase or decrease cooking time by turning **TIME/WEIGHT**.

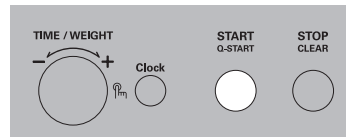

AUTO ROAST GUIDE

Function	Category		Weight Limit	Utensil	Food Temp.	Instructions
Auto Roast 	Ar 1	Roast beef	0.5~1.5 kg	Low rack on the crisp tray	Refrigerated	Brush the meat with oil. Place on the low rack on the crisp tray. When beep sounds, turn food over. After cooking, cover with aluminum foil, let stand for 10 minutes.
	Ar 2	Roast pork	0.5~1.5 kg	Low rack on the crisp tray	Refrigerated	Brush the meat with oil. Place on the low rack on the crisp tray. When beep sounds, turn food over. After cooking, cover with aluminum foil, let stand for 10 minutes.
	Ar 3	Roast Whole Chicken	0.8~1.5 kg	Low rack on the crisp tray	Refrigerated	Wash and dry skin. Brush the chicken with oil. Tie its feet with a cotton thread. Place on the low rack on the crisp tray. When beep sounds, turn food over. After cooking, cover with aluminum foil, let stand for 10 minutes.

Crisp Cook

In the following example I will show you how to cook 0.4 kg of frozen pizza.



This feature allows you to crisp cook.

For the best result, use the following accessories.



Crisp tray + High rack
(or low rack)

CAUTION:

1. Always use culinary gloves when removing a Crisp Tray from the oven. It's very hot.
2. Do not put a hot Crisp Tray on a glass table or a place. Always make sure to use a pad or tray.
3. Never use this Crisp Tray with a product of a different model. It may cause a fire or fatal damage to the product.

Press **STOP/CLEAR**.

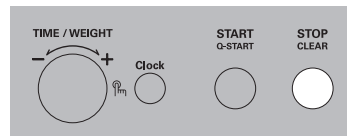

Press **Crisp Cook**.

The following indications are displayed: "🍕".

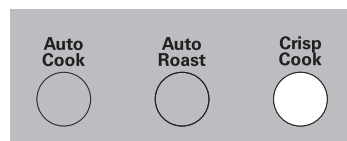

Turn **TIME/WEIGHT** until display shows "cc 1".

Press **TIME/WEIGHT** for category confirmation.

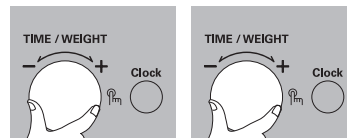

Turn **TIME/WEIGHT** until display shows "0.4kg".

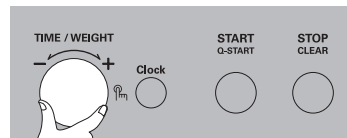

Press **START/QUICK START**.

When cooking you can increase or decrease cooking time by turning **TIME/WEIGHT**.

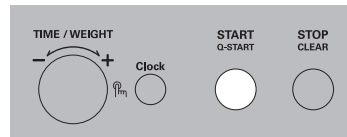
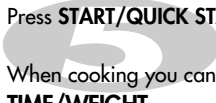

CRISP COOK GUIDE

Function	Category		Weight Limit	Utensil	Food Temp.	Instructions
Crisp Cook 	cc 1	Frozen Pizza	0.3~0.5 kg	Crisp tray on the high rack	Frozen	<p>This function is for cooking frozen pizza. Remove all packaging and place it on the crisp tray on the high rack. After cooking, let stand for 1-2 minutes.</p> <p>CAUTION: The utensil and surrounding oven will get very HOT. Use culinary gloves.</p>
	cc 2	Fresh pizza	0.6 kg	Crisp tray on the low rack	Refrigerated	Carefully follow the fresh pizza recipe below. Place the crisp tray in the oven on the low rack.
	cc 3	Frozen Quiche	0.3~0.6 kg	Crisp tray on the high rack	Frozen	Place the sausage on the crisp tray. Same as above.
	cc 4	Fresh Quiche	0.8 kg	Crisp tray on the low rack	Refrigerated	Carefully follow the chosen fresh quiche recipe below. Place the crisp tray in the oven on the low rack.
	cc 5	Fresh fruit pie	0.8 kg	Crisp tray on the low rack	Refrigerated	Carefully follow the "Single crust apple pie" recipe below. Place the crisp tray in the oven on the low rack.
	cc 6	Chicken Breasts	0.2~0.8 kg	Crisp tray on the high rack	Refrigerated	Place the chicken breasts on the crisp tray. Place the crisp tray on the high rack in the oven. When beep sounds, turn food over.
	cc 7	Chicken wings	0.2~0.8 kg	Crisp tray on the high rack	Refrigerated	Place the chicken wings on the crisp tray. Same as above.
	cc 8	Gratin dauphinois	1.0 kg	Crisp tray on the low rack	Room	Use precooked gratin potatoes. Place the potatoes in the crisp tray with 60g grated cheese. Place crisp tray on the low rack.

*** CRISP COOK (CC2/CC4/CC5) RECIPE**

	<i>Ingredients</i>	<i>Recipe</i>
<p>cc2 Fresh pizza</p>	<p>1 pizza crust 60g pizza sauce 150g grated cheese 70g peppers 40g onions 50g ham</p>	<p>Place the crust onto the crisp tray and prick the surface with a fork. Put the pizza sauce, 50g grated cheese, peppers, onions, ham and 100g grated cheese onto the crust. Place the crisp tray on the low rack.</p>
<p>cc4 Onion and bacon Quiche</p>	<p>1 pie crust 140g onions 3 slices of bacon 3 eggs 300g whipping cream 120g milk 120g grate cheese</p>	<p>Saute the chopped onion and bacon in a frying pan. Mix eggs, whipping cream, milk, and grated cheese. Place the crust onto the crisp tray and prick the surface with a fork. Put the onion and bacon onto the crust and pour the mixture. Place the crisp tray on the low rack.</p>
<p>cc5 Single crust apple pie</p>	<p>1 pie crust 3/4 cup white sugar 2 tablespoons butter, softened 1/3 cup all- purpose flour 1/4 teaspoon ground nutmeg 2 fresh apple-pitted, skinned, and sliced</p>	<p>Place the crust onto the crisp tray and prick the surface with a fork. Cream sugar and butter together. Add flour and nutmeg and mix well. Spread 1/2 of mixture in pie crust. Arrange apples on top of crumb mixture and sprinkle remaining crumb mixture on top of apples. Place the crisp tray on the low rack.</p>

The temperature and density of food varies, I would recommend that the food be checked before cooking begins. Pay particular attention to large joints of meat and chicken, some foods should not be completely thawed before cooking. For example fish cooks so quickly that it is sometimes better to begin cooking while still slightly frozen. This will require a standing time to allow the centre to thaw. In the following example I will show you how to defrost frozen poultry.

Auto Defrost



Your oven has four microwave defrost settings: - **Meat, Poultry, Fish** and **Bread**; each defrost category has different power settings.

Food to be cooked should be placed in a Microwave-safe utensils.

Please do not use the following accessories.



High rack



Low rack

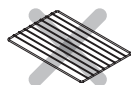

Square rack



Square tray

Press **STOP/CLEAR**.

Weigh the food that you are about to defrost. Be certain to remove any metallic ties or wraps; then place the food on microwave safe dish on the glass tray in your oven and close the oven door.

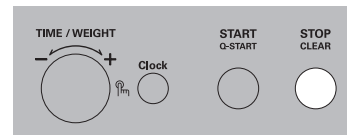

Press **Auto Defrost**.

The following indication is displayed: " $\Delta\Delta$ AUTO "

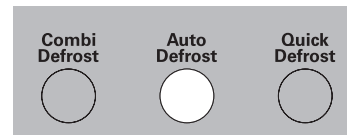

Turn **TIME/WEIGHT** until display shows "dEF2".

Press **TIME/WEIGHT** for category confirmation.

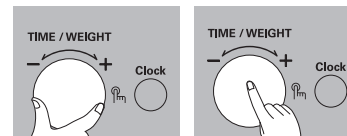

Turn **TIME/WEIGHT** until display shows "0.8kg" for the weight of frozen food.

Press **START/QUICK START**.

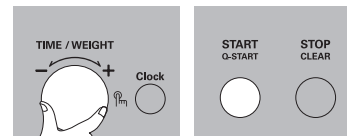

During defrosting your oven will "BEEP", at which point you should open the oven door, turn food over and separate it to ensure even thawing. Remove any portions that have thawed or shield them to help slow down thawing. After checking, close the oven door and press **Start/Quick Start** to resume defrosting. **Your oven will not stop defrosting (even when the beep sounds) unless the door is opened.**

Defrosting Guide

- Food to be defrosted should be placed in a suitable microwave proof container and placed uncovered on the glasstray.
- If necessary, shield small areas of ment or poultry with flat pieces of aluminum foil. This will prevent thin areas from becoming warm during defrosting. Ensure the foil does not touch the oven walls.
- Separate items like minced meat, chops, sausages and bacon as soon as possible.

When BEEP sounds, turn food over. Remove defrosted portions. Continue to defrost remaining pieces.

After defrosting, allow to stand until completely thawed.

Function	Category		Weight Limit	Utensil	Food
Auto Defrost	dEF1	Meat	0.1~4.0 kg	Microwave-safe plate	Minced beef, Fillet steak, Cubes for stew, Sirloin steak, Pot roast, Rump roast, Beet burger Pork chops, Lamb chops, Rolled roast, Sausage, Cutlets(2cm). Turn food over at beep. After defrosting, cover with aluminum foil and let stand for 5-15 minutes.
	dEF2	Poultry			Whole chicken, Legs, Breasts, Turkey breasts(under 2.0kg). Turn food over at beep. After defrosting, let stand for 20-30 minutes.
	dEF3	Fish			Filletts, Steaks, Whole fish, seafood. Turn food over at beep. After defrosting, let stand for 10-20 minutes.
	dEF4	Bread	0.1~0.5 kg	Paper towel	Sliced bread, Buns, Baguette, etc. After defrosting, let stand for 1 minute.

The temperature and density of food varies, I would recommend that the food be checked before cooking begins. Pay particular attention to large joints of meat and chicken, some foods should not be completely thawed before cooking. For example fish cooks so quickly that it is sometimes better to begin cooking while still slightly frozen. This will require a standing time to allow the centre to thaw. In the following example I will show you how to defrost frozen poultry.

Combi Defrost



Your oven has four combination defrost settings:- **Meat, Poultry, Fish** and **Bread**; each defrost category has different power settings.

Your oven has a combination defrost feature which allows you to food with **heater** and **microwave**.

This function makes better result to defrost your food.

For the best result, use the following accessories.



High rack

Press **STOP/CLEAR**.

Weigh the food that you are about to defrost. Be certain to remove any metallic ties or wraps; then place the food on microwave safe dish on high rack in your oven and close the oven door.

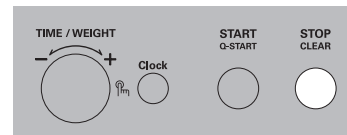

Press **Combi Defrost**.

The following indication is displayed: " ** " " " " "

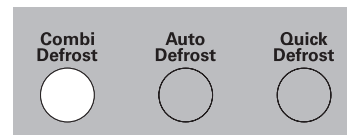

Turn **TIME/WEIGHT** until display shows "dEF2".

Press **TIME/WEIGHT** for category confirmation.

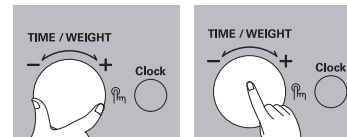

Enter the weight of the frozen food that you are about to defrost.

Turn **TIME/WEIGHT** until display shows "0.8kg" for the weight of frozen food.

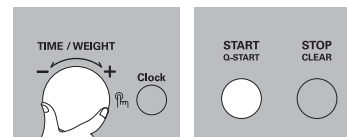

Press **START/QUICK START**.

During defrosting your oven will "BEEP", at which point open the oven door, turn food over and separate to ensure even thawing. Remove any portions that have thawed or shield them to help slow down thawing. After checking, close the oven door and press **Start/Quick Start** to resume defrosting.

Your oven will not stop defrosting (even when the beep sounds) unless the door is opened.

Defrosting Guide

- If necessary, shield small areas of meat or poultry with flat pieces of aluminum foil. This will prevent thin areas from becoming warm during defrosting. Ensure the foil does not touch the oven walls.
- Separate items like minced meat, chops, sausages and bacon as soon as possible.

When BEEP sounds, turn food over. Remove defrosted portions. Continue to defrost remaining pieces.

After defrosting, allow to stand until completely thawed.

Function	Category		Weight Limit	Utensil	Food
Combi Defrost	dEF1	Meat	0.1~4.0 kg	High rack (If the food is too big to defrost on the high rack, use low rack) 	Minced meat, Fillet steak, Cubes for stew, Sirloin steak, Pot roast, Rump roast, Beef burger Pork chops, Lamb chops, Rolled roast, Sausage, Cutlets(2cm). Turn food over at beep. After defrosting, cover with aluminum foil, let stand for 5-15 minutes.
	dEF2	Poultry			Whole chicken, Legs, Breasts, Turkey breasts(under 2.0 kg). Turn food over at beep. After defrosting, cover with aluminum foil, let stand for 20~30 minutes.
	dEF3	Fish			Fillets, Steaks, Whole fish, Sea foods Turn food over at beep. After defrosting, cover with aluminum foil, let stand for 10~20 minutes.
	dEF4	Bread	0.1~0.5 kg		Sliced bread, Buns, Baguette, etc. After defrosting, stand for 1 minute.

Quick Defrost

Use this function to thaw only 0.5kg of minced meat very quickly.
This will require a standing time to allow the center to thaw. The following example will show you how to defrost 0.5kg of frozen meat.



Food to be cooked should be placed in a Microwave-safe utensils.

Please do not use the following accessories.



High rack



Low rack

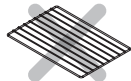

Square rack



Square tray

Press **STOP/CLEAR**.

Weight the food that you are about to defrost. Be certain to remove any metallic ties or wraps; then place the food in your oven and close the oven door.

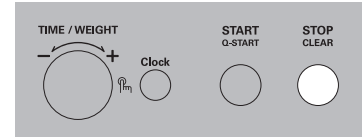

Press **QUICK DEFROST**. (Choose 0.5kg of meat).

The following indication is displayed: " * * * * "

The oven will start automatically.

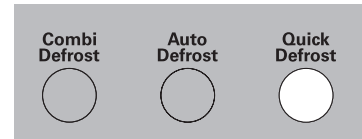

During defrosting your oven will "BEEP", at which point open the oven door, turn food over and separate it to ensure even thawing. Remove any portions that have thawed or shield them to help slow down thawing. close the oven door and press **START/QUICK START** to resume defrosting.

Your oven will not stop defrosting (even when the beep sounds) unless the door is opened.

Quick Defrost Guide

- Use this function to defrost minced meat quickly.
- Remove the meat completely from its wrapping. Place the meat onto a microwave-safe plate.
- When beeps sounds, remove the meat from the microwave oven, turn it over and return it to the microwave oven.
- Press start to continue. At the end of the program remove the meat from the microwave oven, cover with foil and allow to stand for 5-15 minutes or until completely thawed.

<i>Function</i>	<i>Category</i>	<i>Weight Limit</i>	<i>Utensil</i>	<i>Food</i>
Quick Defrost	Minced meat	0.5 kg	Microwave-safe plate	Minced meat. After defrosting, cover with aluminum foil, let stand for 5-15 minutes.

In the following example I will show you how to remove smells from the oven.



The oven has a special function to remove smells in the oven.

You can use the EZ Clean function without food in the oven.

Press **STOP/CLEAR**.

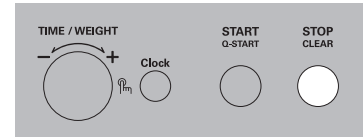

Turn **Mode** until display shows "230°C"

The following indication is displayed: "🕒".

Press **TIME/WEIGHT** for mode confirmation.

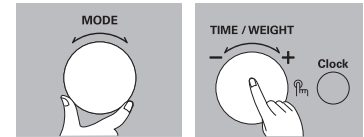
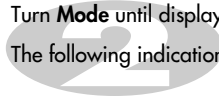

Press **START/QUICK START**.

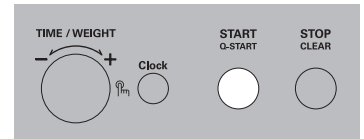

Test dishes in accordance with EN 60705

Function	Meal	Microwave wattage setting	Heating temperature in °C	Notes
Microwave Defrosting	Meat	200W, 10~11min. Or Auto key function	–	Place a flat plate on the center of the glass tray. Turn after half of total cooking time. Or use the “ Auto defrost 1(0.5kg)” function.
Microwave cooking	Custard	400W, 25~30min	–	Place a Pyrex dish on the center of the glass tray.
	Sponge cake	1000W, 4~5min	–	Place a ø22cm Pyrex dish on the center of the glass tray.
	Meat loaf	600W, 13~17min	–	Place a Pyrex dish on the center of the glass tray.
Combination cooking with the microwave	Potato gratin	400W, 25~29min	200°C	Place a ø22cm Pyrex dish on low rack.
	Cake	–	180°C	Place a ø22cm Pyrex dish on low rack.
	Chicken	300W, 38~42min Or Auto key function	200°C	Place chicken breast-side down on the low rack on the crisp tray. Turn after half of total cooking time. Or use the “Auto Roast 3(1.3kg)” function.

Microwave-safe Utensils

Never use metal or metal trimmed utensils in using microwave function

Microwaves cannot penetrate metal. They will bounce off any metal object in the oven and cause arcing, an alarming phenomenon that resembles lightning. Most heat resistant non metallic cooking utensils are safe for use in your oven. However, some may contain materials that render them unsuitable as microwave cookware. If you have any doubts about a particular utensil, there's a simple way to find out if it can be used in the microwave.

Place the utensil in question next to a glass bowl filled with water in using microwave function. Microwave at power HIGH for 1 minute. If the water heats up but the utensil remains cool to the touch, the utensil is microwave-safe. However, if the water does not change temperature but the utensil becomes warm, microwaves are being absorbed by the utensil and it is not safe for use in using microwave function. You probably have many items on hand in your kitchen right now that can be used as cooking equipment in the microwave. Just read through the following checklist.

Dinner plates

Many kinds of dinnerware are microwave-safe. In if doubt consult the manufacturer's literature or perform the microwave test.

Glassware

Glassware that is heat-resistant is microwave-safe. This would include all brands of oven tempered glass cookware. However, do not use delicate glassware, such as tumblers or wine glasses, as these might shatter as the food warms.

Plastic storage containers

These can be used to hold foods that are to be quickly reheated. However, they should not be used to hold foods that will need considerable time in the oven as hot foods will eventually warp or melt plastic containers.

Paper

Paper plates and containers are convenient and safe to use in using microwave function, provided that the cooking time is short and foods to be cooked are low in fat and moisture. Paper towels are also very useful for wrapping foods and for lining baking trays in which greasy foods such as bacon are cooked. In general, avoid coloured paper products as the colour may run. Some recycled paper products may contain impurities which could cause arcing or fires when used in the microwave.

Plastic cooking bags

Provided they are made specially for cooking, cooking bags are microwave safe. However, be sure to make a slit in the bag so that steam can escape. Never use ordinary plastic bags for cooking in using microwave function, as they will melt and rupture.

Plastic microwave cookware

A variety of shapes and sizes of microwave cookware are available. For the most part, you can probably use items you already have on hand rather than investing in new kitchen equipment.

Pottery, stoneware and ceramic

Containers made of these materials are usually fine for use in using microwave function, but they should be tested to be sure.

CAUTION

Some items with high lead or iron content are not suitable as cooking utensils.

Utensils should be checked to ensure that they are suitable for use in the microwave.

Food characteristics & Microwave cooking

Keeping an eye on things

The recipes in the book have been formulated with great care, but your success in preparing them depends on how much attention you pay to the food as it cooks. Always watch your food while it cooks. Your microwave function is equipped with a light that turns on automatically when the oven is in operation so that you can see inside and check the progress of your food. Directions given in recipes to elevate, stir, and the like should be thought of as the minimum steps recommended. If the food seems to be cooking unevenly, simply make the necessary adjustments you think appropriate to correct the problem.

Factors affecting microwave cooking times

Many factors affect cooking times. The temperature of ingredients used in a recipe makes a big difference in cooking times. For example, a cake made with ice-cold butter, milk, and eggs will take considerably longer to bake than one made with ingredients that are at room temperature. All of the recipes in this book give a range of cooking times. In general, you will find that the food remains under-cooked at the lower end of the time range, and you may sometimes want to cook your food beyond the maximum time given, according to personal preference. The governing philosophy of this book is that it is best for a recipe to be conservative in giving cooking times because overcooked food is ruined for good. Some of the recipes, particularly those for bread, cake, and custards, recommend that food be removed from the oven when they are slightly undercooked. This is not a mistake. When allowed to stand, usually covered, these foods will continue to cook outside of the oven as the heat trapped within the outer portions of the food gradually travels inward. If the food is left in the oven until it is cooked all the way through, the outer portions will become overcooked or even burnt. You will become increasingly skillful in estimating both cooking and standing times for various foods.

Density of food

Light, porous food such as cakes and breads cook more quickly than heavy, dense foods such as roasts and casseroles. You must take care when microwaving porous food so that the outer edges do not become dry and brittle.

Height of food

The upper portion of tall foods, particularly roasts, will cook more quickly than the lower portion. Therefore, it is wise to turn tall food several during cooking.

Moisture content of food

Since the heat generated from microwaves causes moisture to evaporate, relatively dry food such as roasts and some vegetables should either be sprinkled with water prior to cooking or covered to retain moisture.

Bone and fat content of food

Bones conduct heat and fat cooks more quickly than meat. Care must be taken when cooking bony or fatty cuts of meat in order to prevent unevenly or overcooked meat.

Quantity of food

The number of microwaves in your oven remains constant regardless of how much food is being cooked. Therefore, the more food you place in the oven, the longer the cooking time. Remember to decrease cooking times by at least one third when halving a recipe.

Shape of food

Microwaves penetrate only about 2 cm into food, the interior portion of thick foods are cooked as the heat generated on the outside travels inward. Only the outer edge of food is cooked by microwave energy; the rest is cooked by conduction. The worst possible shape for a food that is to be microwaved is a thick square. The corners will burn long before the centre is even warm. Round thin foods and ring shaped foods cook most successfully in the microwave.

Covering

A cover traps heat and steam which causes food to cook more quickly. Use a lid or microwave cling film with a corner folded back to prevent splitting.

Browning

Meats and poultry that are cooked fifteen minutes or longer will brown lightly in their own fat. Foods that are cooked for a shorter period of time may be brushed with a browning sauce such as worcestershire sauce, soy sauce or barbecue sauce to achieve an appetizing colour. Since relatively small amounts of browning sauces are added to food, the original flavour of the recipe is not altered.

Covering with greaseproof paper

It is a looser cover than a lid or cling film, the food may dry out slightly. But because it makes a looser cover than a lid or clingfilm, it allows the food to dry out slightly.

Arranging and spacing

Individual foods such as baked potatoes, small cakes and hors d'oeuvres will heat more evenly if placed in the oven an equal distance apart, preferably in a circular pattern. Never stack foods on top of one another.

Food characteristics & Microwave cooking

Stirring

Stirring is one of the most important of all microwaving techniques. In conventional cooking, food is stirred for the purpose of blending. Microwaved food, however, is stirred in order to spread and redistribute heat. Always stir from the outside towards the centre as the outside of the food heats first.

Turning over

Large, tall foods such as roasts and whole chickens should be turned so that the top and bottom will cook evenly. It is also a good idea to turn cut up chicken and chops.

Placing thicker portions facing outwards

Since microwaves are attracted to the outside portion of food, it makes sense to place thicker portions of meat, poultry and fish to the outer edge of the baking dish. This way, thicker portions will receive the most microwave energy and the food will cook evenly.

Shielding

Strips of aluminium foil (which block microwaves) can be placed over the corners or edges of square and rectangular foods to prevent those portions from overcooking. Never use too much foil and make sure the foil is secured to the dish or it may cause 'arcing' in the oven.

Elevating

Thick or dense foods can be elevated so that microwaves can be absorbed by the underside and centre of the foods.

Piercing

Foods enclosed in a shell, skin or membrane are likely to burst in the oven unless they are pierced prior to cooking. Such foods include yolks and whites of eggs, clams and oysters and whole vegetables and fruits.

Testing if cooked

Food cooks so quickly in a oven, it is necessary to test it frequently. Some foods are left in the microwave until completely cooked, but most foods, including meats and poultry, are removed from the oven while still slightly undercooked and allowed to finish cooking during standing time. The internal temperature of foods will rise between 5°F (3°C) and 15°F (8°C) during standing time.

Standing time

Foods are often allowed to stand for 3 to 10 minutes after being removed from the oven. Usually the foods are covered during standing time to retain heat unless they are supposed to be dry in texture (some cakes and biscuits, for example). Standing allows foods to finish cooking and also helps flavour blend and develop.

To Clean Your Oven

1. Keep the inside of the oven clean

Food spatters or spilled liquids stick to oven walls and between the seal and door surfaces. It is best to wipe up spillovers with a damp cloth right away. Crumbs and spillovers will absorb microwave energy and lengthen cooking times. Use a damp cloth to wipe out crumbs that fall between the door and the frame. It is important to keep this area clean to assure a tight seal. Remove greasy spatters with a soapy cloth then rinse and dry. Do not use harsh detergent or abrasive cleaners. The metal tray can be washed by hand or in the dishwasher.

2. Keep the outside of the oven clean

Clean the outside of your oven with soap and water then with clean water and dry with a soft cloth or paper towel. To prevent damage to the operating parts inside the oven, the water should not be allowed to seep into the ventilation openings. To clean control panel, open the door to prevent the oven from accidentally starting, and wipe a damp cloth followed immediately by a dry cloth. Press Stop/Clear after cleaning.

3. If steam accumulates inside or around the outside of the oven door, wipe the panels with a soft cloth. This may occur when the oven is operated under high humidity conditions and in no way indicates a malfunction of the unit.
4. The door and door seals should be kept clean. Use only warm, soapy water, rinse then dry thoroughly.

DO NOT USE ABRASIVE MATERIALS, SUCH AS CLEANING POWDERS OR STEEL AND PLASTIC PADS.

Metal parts will be easier to maintain if wiped frequently with a damp cloth.

5. Do not use steam cleaners.
6. Unplug your oven from the electrical socket when you clean control panel with wet cloth or spray water on control glass to clean. If it is not unplugged, this product can be operated by touching the Quick Start button.

Questions & Answers

Q What's wrong when the oven light will not glow?

A There may be several reasons why the oven light will not glow. Either the light bulb has blown or the electric circuit has failed.

Q Does microwave energy pass through the viewing screen in the door?

A No. The holes, or ports, are made to allow light to pass; they do not let microwave energy through.

Q Why does the beep tone sound when a button on the Control Panel is touched?

A The beep tone sounds to assure that the setting is being properly entered.

Q Will the microwave function be damaged if it operates empty?

A Yes Never run it empty.

Q Why do eggs sometimes pop?

A When baking, frying, or poaching eggs, the yolk may pop due to steam build up inside the yolk membrane. To prevent this, simply pierce the yolk before cooking. Never microwave eggs in the shell.

Q Why is standing time recommended after microwave cooking is over?

A After microwave cooking is finished, food keeps on cooking during standing time. This standing time finishes cooking evenly throughout the food. The amount of standing time depends on the density of the food.

Q Why doesn't my oven always cook as fast as the cooking guide says?

A Check your cooking guide again to make sure you've followed directions correctly, and to see what might cause variations in cooking time. Cooking guide times and heat settings are suggestions, chosen to help prevent overcooking, the most common problem in getting used to this oven. Variations in the size, shape, weight and dimensions of the food require longer cooking time. Use your own judgement along with the cooking guide suggestions to test food conditions, just as you would do with a conventional cooker.

Technical Specifications

Technical Specification

		MC8088HL / MC8088HR
Power Input		230 V~ 50 Hz
Output		1000 W (IEC60705 rating standard)
Microwave Frequency		2450 MHz
Outside Dimension		474 mm(W) X 380 mm(H) X 564 mm(D)
Power Consumption	Max.	3000 watt
	Microwave	1500 watt
	Grill	1250(Max. 2650) watt
	Convection	1500(Max. 2650) watt
	Combination	Max. 3000 watt

If the supplied flexible mains cord of this appliance is damaged, it must be replaced using the special mains cord part number : 6411W1A017S

This appliance is supplied with BS 1363 approved 13 Amp fused mains plug.
When replacing the fuse always use a 13 Amp BS 1362 approved type. Never use this plug with the fuse cover omitted. To obtain a replacement fuse cover contact your supplying dealer or LG Electronics U.K. LTD.

If the mains sockets in your home differ, or are not suitable for the type of plug supplied then the plug should be removed and a suitable type fitted.

If the mains plug becomes severed from the mains lead it must be destroyed. A mains plug with bared wires is hazardous if engaged in a mains output line socket.

If a 13 Amp BS 1363 plug is not suitable or any other type of plug used, then this appliance must be protected by a 15 Amp fuse.

Reheating Cooked Chilled Foods

The oven has been tested and labeled to the Ministry of Agriculture Fisheries and Food (MAFF) agreement, concerning the reheating of cooked chilled food.

The heating characteristics and output power levels of oven with microwave function are usually calculated using a 1000 gram load, (IEC 60705). However, at smaller loads the heating characteristics of the oven with microwave function change. Most prepacked food normally falls into this category, usually being packed in smaller individual portions of approx. 350 grams. Therefore, it was clear that a new approach for reheating this type of food was required.

MAFF working in partnership with the food companies and oven(with microwave function) manufacturers such as 'LG electronics' have overcome this problem by the introduction of heating categories.

Because you may not yet be familiar with this system, we have used the following explanation as an example. However, please refer to the actual rating as printed on the oven door.

Displayed on the food packages will be the cooking times for each of the BAND categories. For example: A may be 10 minutes. B may be 9 minutes etc depending on the food type.

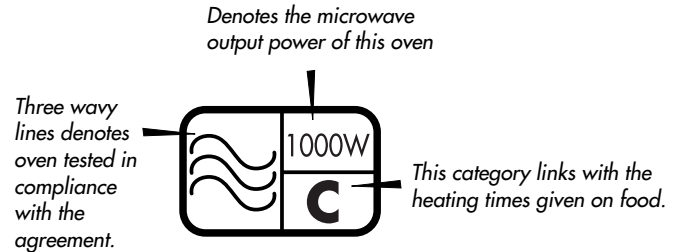

When applying this method for reheating cooked chilled food stuffs, the following information must be adhered to:

- 1 The microwave output power of this oven must be set at maximum power level. (refer to instructions)
- 2 Refer to the cooking instructions given on the packaging.
- 3 As with all cooked food, check for evenness of cooking and ensure that foods are piping hot, prior to consumption.



Technology with the human touch
GUARANTEE

LG ELECTRONICS U.K. LTD. WILL PROVIDE THE FOLLOWING SERVICES IN ORDER TO EXPEDITE THIS GUARANTEE.

1. All faulty components which fail due to defective manufacture will be replaced free of charge for a period of 12 months from the original date of purchase.
2. The dealer (or his Service Agent) who sold the product will be reimbursed for any labor provided in the repair of this LG electronics equipment, for a period of 12 months from the original date of purchase. These claims must be made in accordance with the published scale of service charges and relevant claims procedure.

PLEASE NOTE:

- A. The dealer may restrict the guarantee to the original purchaser.
- B. The dealer is not obliged to carry out service under guarantee if unauthorized modifications are made to the apparatus, or if non standard components are used or if the serial number of the apparatus is removed, defaced, misused, or altered.
- C. Any claims made under guarantee must be directed to the dealer from whom the equipment was originally purchased. The dealer may, before carrying out service under guarantee, require a receipted account as evidence of the date of purchase.
- D. We respectfully point out that your dealer is not obligated to replace batteries if they become exhausted or worn in use.
- E. Aerial alignment and consumer control adjustments are not covered by this guarantee.

This guarantee does not affect your statutory rights.

REQUIREMENTS TO MAINTAIN WARRANTY COVERAGE:

RETAIN YOUR RECEIPT TO PROVE DATE OF PURCHASE. A COPY OF YOUR RECEIPT MUST BE SURRENDERED AT THE TIME GUARANTEE SERVICE IS PROVIDED.

PRODUCT REGISTRATION CARD: It is helpful to complete at least, your name, address, phone, model & serial numbers and return it. This will enable LG Electronics to assist you in the future should you lose your receipt, your units stolen, or should modification be necessary.

To obtain information or assistance: Call 01753 500470 Monday-Friday 9:00 am ~ 4:30 pm

MODEL	SERIAL# *	DATE OF PURCHASE

* Please complete for your own record

In all cases of difficulty - consult your LG dealer from whom the product was purchased.



LG Electronics Inc.



Disposal of your old appliance

1. When this crossed-out wheeled bin symbol is attached to a product it means the product is covered by the European Directive 2002/96/EC.
2. All electrical and electronic products should be disposed of separately from the municipal waste stream via designated collection facilities appointed by the government or the local authorities.
3. The correct disposal of your old appliance will help prevent potential negative consequences for the environment and human health.
4. For more detailed information about disposal of your old appliance, please contact your city office, waste disposal service or the shop where you purchased the product.

Printed in China

Free Manuals Download Website

<http://myh66.com>

<http://usermanuals.us>

<http://www.somanuals.com>

<http://www.4manuals.cc>

<http://www.manual-lib.com>

<http://www.404manual.com>

<http://www.luxmanual.com>

<http://aubethermostatmanual.com>

Golf course search by state

<http://golfingnear.com>

Email search by domain

<http://emailbydomain.com>

Auto manuals search

<http://auto.somanuals.com>

TV manuals search

<http://tv.somanuals.com>