

SHARP®

CAROUSEL® II OVER THE RANGE CONVECTION MICROWAVE OVEN

MODELS R-1830/R-1831

OPERATION MANUAL

1830

FOR CUSTOMER ASSISTANCE

To aid in reporting this microwave oven in case of loss or theft, please record below the model number and serial number located on the unit. We also suggest you record all the information listed and retain for future reference.

MODEL NUMBER _____	SERIAL NUMBER _____
DATE OF PURCHASE _____	
Dealer _____	Telephone _____
Service Station _____	Telephone _____

TO PHONE:

SERVICE800-447-4700
(for your nearest Sharp Authorized Service Center)
PARTS800-447-4700
(for your Authorized Parts Distributor)
ACCESSORIES800-642-2122
ADDITIONAL
CUSTOMER INFORMATION201-512-0055
COOKING ASSISTANCE201-529-8703

TO WRITE:

For cooking and operation questions:

Susan Edwards/Test Kitchen
Sharp Electronics Corporation
Sharp Plaza, Box 650
Mahwah, NJ 07430-2135

For service problems, warranty information, missing items and other assistance:

Sharp Electronics Corporation
Customer Information Center
Sharp Plaza, Box 650
Mahwah, NJ 07430-2135

Please provide the following information when you write or call: model number, serial number, date of purchase, your complete mailing address (including zip code), your daytime telephone number (including area code) and description of the problem.

CONTENTS

Contents	1	Convection and Automatic Mix Cooking	17
Precautions to Avoid Possible Exposure to Excessive Microwave Energy	1	To Cook with Convection	18
Limited Warranty	2	To Cook with Automatic Mix	18
Product Information Card	2	To Preheat and Cook with Convection	19
Letter to Sharp Customer	3	To Preheat and Cook with Automatic Mix	19
Grounding Instructions	4	To Sequence Cook with Automatic Mix	19
Specifications	4	Convection Cooking Using Temperature Probe	20
Important Safety Instructions	5	Automatic Mix Cooking Using Temperature Probe	20
Oven Diagram	6	Convection and Microwave Cooking	21
Touch Control Panel	7	Broiling	22
Accessories	7	Slow Cook	23
Optional Accessories	7	Minute Plus	23
Operation of Auto-Touch Control Panel	8	CompuCook	24
To Set the Clock	8	To Cook with CompuCook	24
Minute Timer	9	CompuCook Chart	25
Stop/Clear	9	Auto Start	25
Time Cooking	9	Sensor Cooking	26
Multiple Sequence Cooking	10	Reheat Sensor	27
Pause	10	Popcorn Sensor	27
Minute Plus	10	To Cook with Sensor	27
Auto Start	10-11	Reheat Sensor Chart	27
CompuDefrost	11-12	Popcorn Sensor Chart	27
CompuDefrost Chart	12-13	Pizza Sensor Chart	27
Temperature Probe Cooking	14	Sensor Cook Chart	28
To Cook with Temperature Probe	15	Sensor Cook Recipes	29-30
To Monitor Temperature	15	Cautious Reminders	31
Sensor Temp	16	Condensation	31
Sensor Temp Chart	16	Cleaning and Care	32-33
		Service Call Check	34
		Touch Guide	Back Cover

PRECAUTIONS TO AVOID POSSIBLE EXPOSURE TO EXCESSIVE MICROWAVE ENERGY

- (a) Do not attempt to operate this oven with the door open since open-door operation can result in harmful exposure to microwave energy. It is important not to defeat or tamper with the safety interlocks.
- (b) Do not place any object between the oven front face and the door or allow soil or cleaner residue to accumulate on sealing surfaces.
- (c) Do not operate the oven if it is damaged. It is particularly important that the oven door close properly and that there is no damage to the:
(1) door (bent), (2) hinges and latches (broken or loosened), (3) door seals and sealing surfaces.
- (d) The oven should not be adjusted or repaired by anyone except properly qualified service personnel.

LIMITED WARRANTY

SHARP ELECTRONICS CORPORATION warrants to the first consumer purchaser that this Sharp brand product (the "Product"), when shipped in its original container, will be free from defective workmanship and materials, and agrees that it will, at its option, either repair the defect or replace the defective Product or part thereof at no charge to the purchaser for parts or labor for the time period(s) set forth below.

This warranty does not apply to any appearance items of the Product nor to any Product the exterior of which has been damaged or defaced, which has been subjected to misuse, abnormal service or handling, or which has been altered or modified in design or construction. (See below for possible additional exclusions.)

In order to enforce the rights under this limited warranty, the purchaser should ship or carry the Product to a Sharp Service Dealer or Station in the United States (except where in-home service is provided as indicated below) and provide proof of purchase. To find the location of the nearest Sharp Service Dealer or Station call Sharp toll-free at 800-447-4700.

The limited warranty described above is in addition to whatever implied warranties may be granted to purchasers by law. ALL IMPLIED WARRANTIES INCLUDING THE WARRANTIES OF MERCHANTABILITY AND FITNESS FOR USE ARE LIMITED TO THE PERIOD(S) FROM THE DATE OF PURCHASE SET FORTH BELOW. Some states do not allow limitations on how long an implied warranty lasts, so the above limitation may not apply to you.

Neither the sales personnel of the seller nor any other person is authorized to make any warranties other than those described above, or to extend the duration of any warranties beyond the time period described above on behalf of Sharp.

The warranties described above shall be the sole and exclusive warranties granted by Sharp and shall be the sole and exclusive remedy available to the purchaser. Correction of defects, in the manner and period of time described herein, shall constitute complete fulfillment of all liabilities and responsibilities of Sharp to the purchaser with respect to the Product, and shall constitute full satisfaction of all claims, whether based on contract, negligence, strict liability or otherwise. In no event shall Sharp be liable, or in any way responsible for any damages or defects in the Product which were caused by repairs or attempted repairs performed by anyone other than a Sharp Service Dealer or Station. Nor shall Sharp be liable or in any way responsible for any incidental or consequential economic or property damage. Some states do not allow the exclusion of incidental or consequential damages, so the above exclusion may not apply to you.

The limited warranty does not apply to accessories, rubber or plastic parts, the turntable, light bulbs, glass parts or any printed materials.

R-1830/R-1831 Home Microwave Oven has a Two (2) year parts and labor, Seven (7) year magnetron, in-home warranty. In-Home service: The servicer will come to the unit's location. If it is necessary to remove the unit for repair, the servicer will reinstall the unit at no extra charge.

THIS WARRANTY GIVES YOU SPECIFIC LEGAL RIGHTS. YOU MAY ALSO HAVE OTHER RIGHTS WHICH VARY FROM STATE TO STATE.

PRODUCT INFORMATION CARD

The product information card which is on the inside of the microwave oven carton should be completed within ten days of purchase and returned. We will keep it on file and help you access the information in case of loss, damage or theft. This will also enable us to contact you in the unlikely event that any adjustments or modifications are ever required for your oven.

SHARP MICROWAVE OVEN TEST KITCHEN

SHARP ELECTRONICS CORPORATION

Sharp Plaza, Mahwah, New Jersey 07430-2135

Dear Sharp Customer:

We are pleased that you've chosen a Sharp Carousel II Convection Microwave Oven. Now that you have decided to join the millions of microwave oven owners, we at Sharp want you to get the maximum enjoyment and user from your Sharp oven.

Before you use your oven for the first time, please read this book carefully. It is very important that you understand and follow this Operation Manual. Your entire family should know how to operate the oven correctly so each of you can easily use and benefit from the oven.

This manual is a companion to your Sharp Carousel Convection Microwave Cookbook. Refer to both frequently as you learn to use your oven.

Sharp's home economics staff is eager to help if you have questions.

On any correspondence, please indicate:

- * the model number of your oven.
- * your complete mailing address.
- * your telephone number - home and business
(Please include area code and zip code.)

Best Wishes !

Susan Edwards

Susan Edwards
Sharp Test Kitchen
Sharp Plaza
Mahwah, NJ 07430-2135

GROUNDING INSTRUCTIONS

This appliance must be grounded. In the event of an electrical short circuit, grounding reduces the risk of electric shock by providing an escape path for the electric current. This appliance is equipped with a cord having a grounding wire with a grounding plug. The plug must be plugged into an outlet that is properly installed and grounded.

WARNING-Improper use of the grounding plug can result in a risk of electric shock.

Consult a qualified electrician or serviceman if grounding instructions are not completely understood or if doubt exists as to whether the appliance is properly grounded.

If it is necessary to use an extension cord, use only a 3-wire extension cord that has a 3-blade grounding plug and a 3-slot receptacle that will accept the plug on the appliance. The marked rating of the extension cord should be AC 115-120 Volt, 15 Amp. or more.

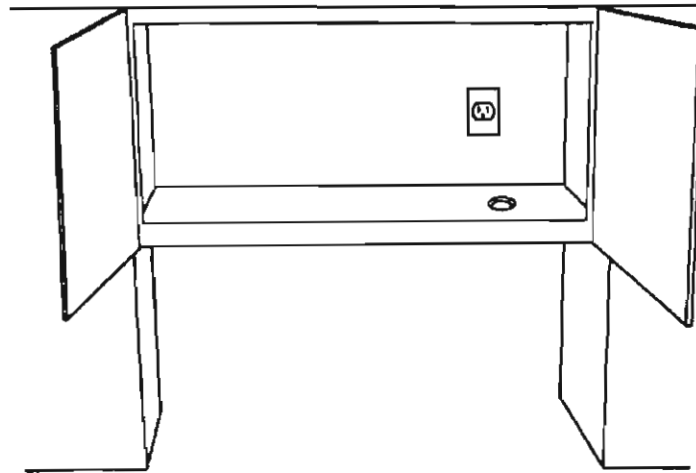

DO NOT UNDER ANY CIRCUMSTANCES CUT OR REMOVE THE ROUND GROUNDING PRONG FROM THE PLUG.

SPECIFICATIONS:

AC Line Voltage:	Single phase 120V, 60 Hz, A.C. only
AC Power Required:	1.6 kW (Microwave) 1.6 kW (Convection)
Output Power:	
Microwave	800 W (IEC – 705 Test Procedure), 2450 MHz
Convection Heater	1350W
Outside Dimensions	29-7/8"(W), 16 1/2"(H), 15"(D)
Cavity Dimensions	13-5/8"(W), 8-3/8"(H), 13-1/2"(D)
Weight	Approx. 74 lbs.
Hood Lamp	2 lamps (40W x 2, incandescent lamp)
Hood Fan	Horizontal discharge 310 C.F.M. Vertical discharge 300 C.F.M.

In compliance with standards set by:

FCC - Federal Communications Commission Authorized

DHHS - Complies with Department of Health and Human Services (DHHS) Rule, CFR, Title 21, Chapter 1, Subchapter J.



- This symbol on the nameplate means the product is listed by Underwriter's Laboratories. Carousel and Auto-Touch are registered trademarks of Sharp Electronics Corporation.

IMPORTANT SAFETY INSTRUCTIONS

When using electrical appliances, basic safety precautions should be followed, including the following:

WARNING - To reduce the risk of burns, electric shock, fire, injury to persons or exposure to excessive microwave energy:

1. Read all instructions before using the appliance.
2. Visually check after unpacking:
Remove all packing material from the oven cavity.
Check the oven for any damage, such as misaligned door, damaged gaskets around door or dents inside the oven cavity or on the door. If there is any damage, please do not operate the oven until it has been checked by a Sharp Authorized Service Station and any repairs made, if necessary.
3. Read and follow the specific **"PRECAUTIONS TO AVOID POSSIBLE EXPOSURE TO EXCESSIVE MICROWAVE ENERGY"** on page 1.
4. This appliance must be grounded. Connect only to properly grounded outlet. See **"GROUNDING INSTRUCTIONS"** on page 4.
5. Install or locate this appliance only in accordance with the provided installation instructions.
6. Some products such as whole eggs and sealed containers - for example, closed glass jars - may explode and should not be heated in this oven.
7. Use this appliance only for its intended use as described in this manual.
8. As with any appliance, close supervision is necessary when used by children.
9. Do not operate this appliance if it has a damaged cord or plug, if it is not working properly, or if it has been damaged or dropped.
10. This appliance should be serviced only by qualified service personnel. Contact nearest Sharp Authorized Service Station for examination, repair or adjustment.
11. Do not block or cover any openings on the appliance.
12. Do not use outdoors.
13. Do not immerse cord or plug in water.
14. Keep cord away from heated surfaces.
15. Do not let cord hang over edge of table or counter.
16. See door surface cleaning instructions on page 32.
17. To reduce the risk of fire in oven cavity:
 - a. Do not overcook food. Carefully attend appliance if paper, plastic, or other combustible materials are placed inside the oven to facilitate cooking.
 - b. Remove wire twist-ties from paper and plastic bags before placing bag in oven.
 - c. If materials inside oven should ignite, keep oven door closed, turn oven off, and disconnect the power cord, or shut off power at the fuse or circuit breaker panel.
18. The appliance is specifically designed to heat or cook foods and is not intended for industrial or laboratory use. Do not attempt to heat corrosive chemicals in the microwave oven.
19. Do not use your conventional gas or electric range as a space heater when a Sharp Over the Range Oven is installed above it. The intense heat produced may damage the oven.

SAVE THESE INSTRUCTIONS

OVEN DIAGRAM

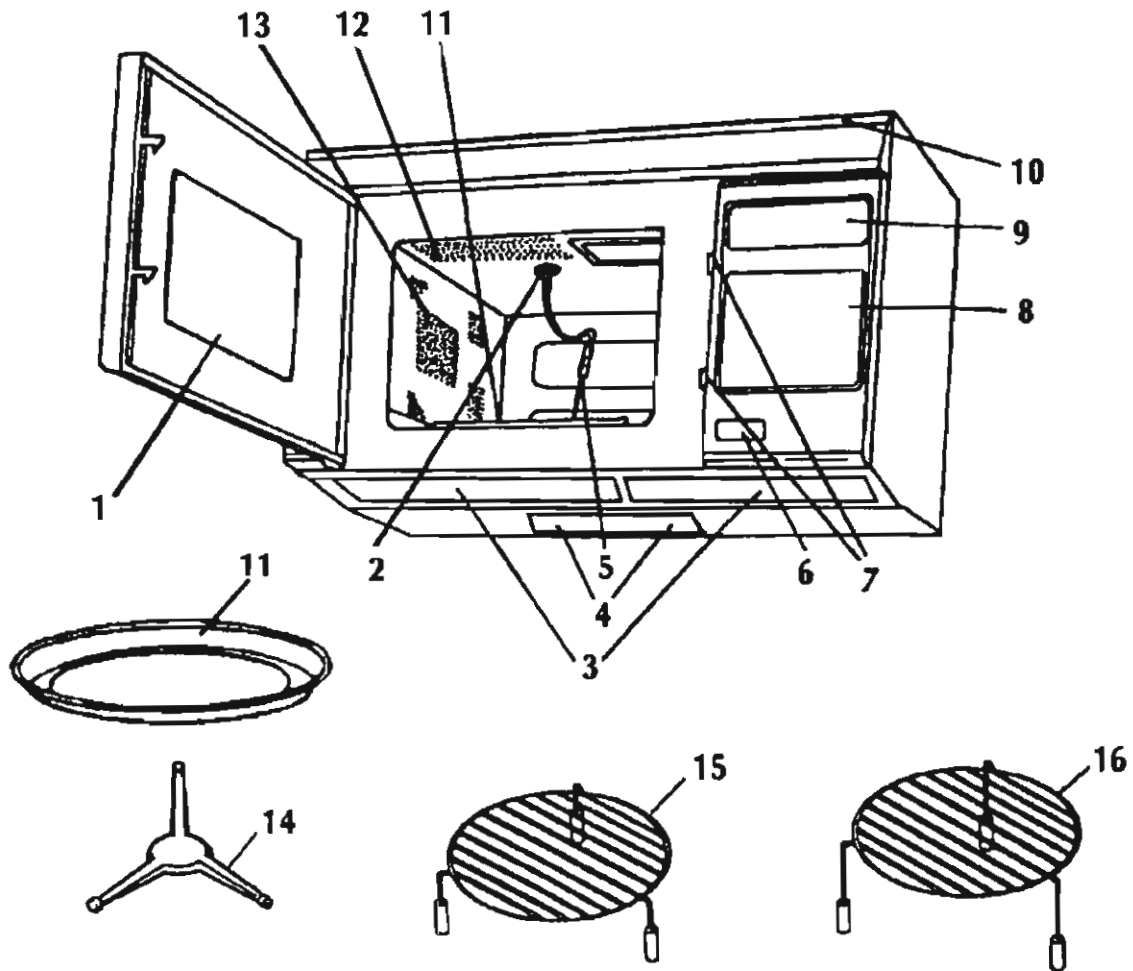

1. Oven door with see-through window.
2. Temperature probe receptacle.
3. Grease filters.
4. Hood lamps.
5. Removable temperature probe.
6. One touch door opener.
7. Door latches.
8. Auto-Touch control panel.
9. Lighted digital display.
10. Ventilation openings.
11. Removable turntable.
12. Oven lamp.
13. Convection air openings.
14. Turntable support. (It must be placed under the removable turntable.)
15. Broiling trivet.
16. Baking rack.

TOUCH-CONTROL PANEL

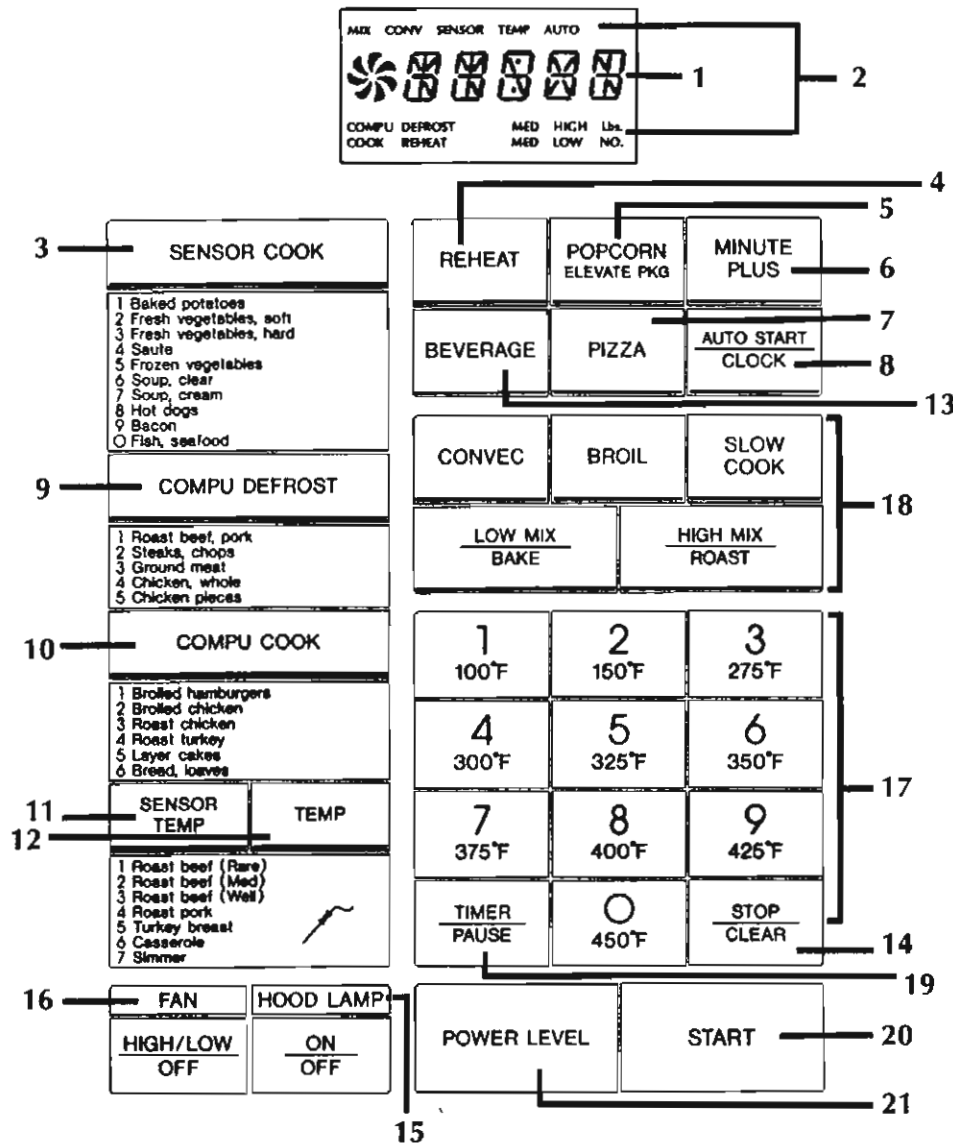

FEATURES

1. Lighted digital display
2. Indicators
3. SENSOR COOK pad
4. REHEAT SENSOR pad
5. POPCORN pad
6. MINUTE PLUS pad
7. PIZZA pad
8. AUTO START/CLOCK pad
9. COMPU DEFROST pad
10. COMPU COOK pad
11. SENSOR TEMP pad
12. TEMP pad
13. BEVERAGE REHEAT pad
14. STOP/CLEAR pad
15. HOOD LAMP pad
16. FAN pad.
Press once for HIGH and twice for LOW
Press again for OFF
17. Number and Temperature selection pads
18. Cooking Function pads
19. TIMER/PAUSE pad
20. START pad
21. POWER LEVEL pad

ACCESSORIES

The following accessories are designed especially for use in this oven. The racks are for convection and combination cooking only; do not use for microwave cooking alone. Do not substitute similar types of racks for these specially designed ones.

Broiling Trivet

Used for roasting or broiling to allow juices to drain away from food.



Baking Rack

This rack is used for two-layer cooking, such as layer cakes, muffins, etc.



OPTIONAL ACCESSORIES - - If your dealer does not stock these items, they can be ordered directly from your SHARP Accessories and Supplies Center. For location of the nearest center, call toll-free 1-800-642-2122.

1. Charcoal Filter Kit (RK-210). Required when hood exhaust is recirculated. See Installation Instructions.
2. Filler Panel Kit (RK-250). Used when installing the unit in a 36" or 42" opening. The 3" panels come in pairs.

Operation of Auto-Touch® Control Panel

Your new Sharp Auto-Touch convection microwave oven uses a microprocessor, the electronic brain that provides a wide variety of cooking programs which could not be achieved by conventional control methods. The operation of the oven is controlled by touching the appropriate pads arranged on the surface of the control panel.

An entry signal tone should be heard each time you touch the control panel to make a correct entry. If you do not hear this sound:

- 1) You have not used enough pressure in touching the pad.
- 2) You have made more entries than the control panel will accept.
- 3) You have made an incorrect entry.

In addition to the entry signal tone, an audible signal will sound for approximately 2 seconds at the end of the cooking cycle.

After cooking or using the minute timer, the time of day will appear on the display.

- * Make sure the oven is plugged into a 3-pronged 115-120 volt household outlet. When the oven is plugged in, the display will show **88:88**, flashing on and off each second. Touch the STOP/CLEAR pad: **1:00** will appear.
- * You cannot program the oven if the door is not closed firmly.
- * This oven can be programmed for up to 4 automatic sequences. (EX.: Microwave Med - Microwave High - Pause - High Mix Roast)
- * During cooking, the program cannot be changed until the STOP/CLEAR pad is touched twice. All functions are locked in to prevent accidental changes.
- * During cooking, when the door is opened, the cooking time in the readout automatically stops. The cooking time starts to count down again when the door is closed and the START pad is touched.
- * If the electrical power to your microwave oven is interrupted, the display will intermittently show **88:88** after the power is reinstated. If this occurs during cooking, the program will be erased. Simply reset the clock for the correct time of day and reprogram.

To Set the Clock

- * Suppose you want to enter the correct time of day 12:30 (A.M. or P.M.)

Step	Procedure	Pad Order
1.	Touch the AUTO START/CLOCK pad.	AUTO START CLOCK
2.	Enter the correct time of day by touching the numbers in sequence.	1 2 3 0
3.	Touch AUTO START/CLOCK pad again.	AUTO START CLOCK

NOTE: 1. This is a 12 hour clock. **ERROR** will appear in the readout if you attempt to enter an incorrect clock time. For example, if you try to enter 8:61 or 13:00, **ERROR** and the incorrect clock time will appear repeatedly. To erase **ERROR**, touch the STOP/CLEAR pad. If you accidentally touch more than 4 number pads, the last 4 numbers you have touched will appear on the display.

2. If the oven is in cooking or minute timer mode and you wish to know the time of day, simply touch the AUTO START/CLOCK pad. As long as your finger is touching the pad, the time will be displayed. This checking operation does not interfere with the cooking time, oven temperature, or minute timer.

Minute Timer

The Auto-Touch control panel can be used as a timer up to 99 minutes, 99 seconds. There is no cooking involved.
 * Suppose you want to make a 3 minute long distance phone call.

Step	Procedure	Pad Order
1.	Enter desired time.	<input type="text" value="3"/> <input type="text" value="0"/> <input type="text" value="0"/>
2.	Touch TIMER/PAUSE pad.	<input type="text" value="TIMER PAUSE"/>

To cancel the minute timer during operation, touch the STOP/CLEAR pad and the time of day will reappear.

Stop/Clear

Use the STOP/CLEAR pad to:

1. Erase if a mistake is made during programming.
2. Cancel minute timer.
3. Stop the oven temporarily during cooking.
4. Cancel a program during cooking, touch twice.

Your oven can be programmed for up to 99 minutes, 99 seconds.

Time Cooking

There are eleven preset power levels.

Touch Power Level Pad, Then	Approximate Percentage of Power	Approximate Power Level for commonly used words
POWER LEVEL	100%	High
9	90%	
8	80%	Medium High
7	70%	
6	60%	
5	50%	Medium
4	40%	Med Low/Defrost
3	30%	
2	20%	
1	10%	
0	0%	Hold

NOTE: It is not necessary to touch POWER LEVEL pad for 100% if only using one sequence or if programming last sequence.

It can be programmed for up to 4 cooking sequences.

* Suppose you want to heat soup for 2 minutes 30 seconds at 50%.

Procedure	Display
1 <input type="text" value="2"/> <input type="text" value="3"/> <input type="text" value="0"/> Enter cooking time.	2 . 30
2 <input type="text" value="POWER LEVEL"/> Touch POWER LEVEL pad.	P -
3 <input type="text" value="5"/> Select power level.	P - 50
4 <input type="text" value="START"/> Touch START pad.	COOK 2 . 30

NOTE: If you wish to know power level, simply touch the POWER LEVEL pad. As long as your finger is touching the POWER LEVEL pad, the power level will be displayed.

Beverage

You can reheat beverage by touching just one pad.

* Suppose you want to reheat half mug of beverage.

Procedure	Display
1 <input type="text" value="BEVERAGE"/> Touch BEVERAGE pad.	<input type="text" value="RE-"/> <input type="text" value="HEAT"/>

Beverage can only be entered within 1 minute after cooking, closing the door or touching the STOP/CLEAR pad.

* When you select Beverage the heating time will appear on the display and countdown.

TIP: This setting is good for restoring a half mug of cooled beverage to a better drinking temperature. Stir after cooking.

Multiple Sequence Cooking

Your Model can be programmed for up to 4 automatic cooking sequences, switching from one power level setting to another automatically.

* Suppose you want to cook roast beef for 5 minutes at 100% and then continue to cook for 30 minutes at 50%.

Procedure	
1 [5] [0] [0] Enter first cooking program. [POWER LEVEL] x 2 Touch POWER LEVEL pad twice for 100% power.	
2 [3] [0] [0] [0] Enter second cooking program. [POWER LEVEL] Touch POWER LEVEL pad. [5] Touch number pad for 50% power.	
3 [START] Touch START pad.	

NOTE: If 100% is selected as the final sequence, it is not necessary to touch the POWER LEVEL pad.

Pause

Pause allows you to stop the oven between cooking stages to stir, turn food over or add ingredients during the cooking process.

* Suppose you want to cook soup for 5 minutes at 100%, stir and continue to cook for 3 minutes at 50%.

Procedure	
1 [5] [0] [0] Enter cooking time for first stage. [POWER LEVEL] x 2 Touch POWER LEVEL pad twice for 100% power.	

2 [TIMER PAUSE] Touch TIMER/PAUSE pad.	
3 [3] [0] [0] Enter cooking program for second stage. [POWER LEVEL] Touch POWER LEVEL pad. [5] Touch number pad 5 for 50% power.	
4 [START] Touch START pad.	
5 After the 1st stage, open door and stir soup. Close door.	
6 [START] Touch START pad.	

Minute Plus

Minute Plus allows you to cook for a minute at 100% by simply touching the MINUTE PLUS pad. You can also extend cooking time in multiples of 1 minute by repeatedly touching the MINUTE PLUS pad during cooking.

* Suppose you want to heat a cup of soup for one minute.

Procedure	
1 [MINUTE PLUS] Touch MINUTE PLUS pad.	

NOTE: 1. Minute Plus can only be entered within 1 minute after cooking, closing the door, touching the STOP/CLEAR pad or during cooking. Minute Plus cannot be used to start the oven if any program is on display.
2. Minute Plus cannot be used with Special Features.

Auto Start

If you wish to program your oven to begin cooking automatically at a designated time of day, follow this procedure:

* Suppose you want to start cooking a stew for 20 minutes on 50% at 4:30. Before setting, check to make sure the clock is showing the correct time of day.

Procedure	
1 [4] [3] [0] Enter the start time.	
2 [AUTO START CLOCK] Touch AUTO START/CLOCK pad.	

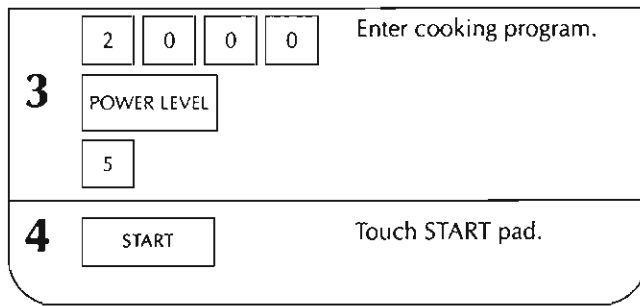

NOTE: 1. Auto Start cannot be used with Special Features.
2. If the oven door is opened after programming Auto Start, it is necessary to touch the START pad for the time of day to appear in the readout so that the oven will automatically begin programmed cooking at the chosen Auto Start time.

CompuDefrost

Your oven has special function keys to defrost meats and poultry faster and better. CompuDefrost automatically defrosts roast beef, pork, steaks, chops, ground meat, whole chicken and chicken pieces. Each key has 3 defrosting stages.

* Suppose you want to defrost a 2 lb. steak with CompuDefrost.

Step	Procedure	Pad Order	Display
1.	Touch COMPU DEFROST pad.	COMPU DEFROST	COMPU DEFROST F 0 0 0
2.	Select desired CompuDefrost setting. Touch 2 to defrost steak.	2	COMPU DEFROST C D - 2 Lbs. Lbs. will flash on and off.
3.	Touch number pads to enter weight.	2 0	COMPU DEFROST 2 . 0 Lbs. Lbs. stops flashing and remains on display.
4.	Touch START pad.	START	COMPU DEFROST COOK 7 . 3 0 When the 1st stage finishes, an audible signal will sound 4 times and oven will stop. TURN , OVER , and COVER , EDGE will be displayed repeatedly.
5.	Open the door. Turn steak over and shield any warm portions. Close the door.		PRESS and START will be displayed repeatedly.
6.	Touch START pad.	START	COMPU DEFROST COOK 5 . 0 0 When the second stage finishes, an audible signal will sound 4 times and oven will stop. LOOK , COVER and EDGE will be displayed repeatedly.
7.	Open the door. Shield any warm portions. Close the door.		PRESS and START will be displayed repeatedly.

Step	Procedure	Pad Order	Display
8.	Touch START pad.	START	 <p>When the 3rd stage finishes, an audible signal will sound. COVER and STAND will be displayed continuously.</p>

Open oven door or touch STOP/CLEAR pad. The time of day will reappear on the display.

NOTE:

1. The weight can be entered in 0.1 lb. increments. Pounds must be rounded off to the nearest tenth of a pound. (Example: 1.75 lbs. should be rounded off to 1.8 lbs.)
2. Foods weighing more or less than the quantity listed in the chart should be defrosted following guidelines in the cookbook. If the incorrect weight is entered and START pad is touched, ERROR and incorrect weight will be displayed repeatedly. The STOP/CLEAR pad has to be touched to reprogram the oven.
3. Elevate whole chicken or roast on a microwave safe roasting rack or inverted saucer set on a microwave safe utility dish. Defrost roasts with fat side down, turn over when oven signals.

CompuDefrost Chart

Setting	Food	Quantity	Display	Procedure	Comment
1	Roast Beef, Pork	2.5 to 6.0 lbs.	TURN OVER COVER EDGE LOOK COVER EDGE	* After the 1st stage, turn over and shield the warm portions with aluminum foil. *After the 2nd stage, if there are warm portions, shield with aluminum foil.	Let stand, covered, 30-45 minutes
2	Steaks Chops Fish	0.5 to 4.0 lbs.	TURN OVER COVER EDGE LOOK COVER EDGE	* After the 1st stage, turn over and shield the warm portions with aluminum foil. *After the 2nd stage, if there are warm portions, shield with aluminum foil.	Let stand, covered, 10-15 minutes.
3	Ground meat	0.5 to 3.0 lbs.	PULL APART RE- MOVE	*Remove any thawed pieces after each stage.	Let stand, covered, 5-10 minutes.
4	Chicken, whole	2.5 to 6.0 lbs.	TURN OVER COVER EDGE LOOK COVER EDGE	* After the 1st stage, turn over and shield the warm portions with aluminum foil. *After the 2nd stage, if there are warm portions, shield with aluminum foil.	Remove giblets before freezing poultry. Let stand covered, 30-55 minutes.

CompuDefrost Chart

Setting	Food	Quantity	Display	Procedure	Comment
5	Chicken pieces	0.5 to 3.0 lbs.	PULL APART RE-ARRANG RE-ARRANG COVER EDGE	*After 2nd stage, if there are warm or thawed portions, rearrange or remove.	Let stand, covered, 10-15 minutes.

NOTE: Check foods when oven signals. After the final stage, small sections may still be icy. Let stand to continue thawing. Do not cook until all ice crystals are thawed. Shielding roasts and steaks prevents cooking from occurring before the center of the food is defrosted. Use small strips of aluminum foil to shield edges and thinner sections of the food.

Temperature Probe Cooking

Your oven is equipped with a removable temperature probe. Suggested cooking and serving temperatures are given throughout the cookbook. Please refer to the beginning of each chapter and to individual recipes for temperature guidelines.

To Use the Temperature Probe

1. Insert the pointed metal thermometer portion (B) of the temperature probe into the food. It is easier to position the probe correctly if this is done while the food is outside the oven. Be sure to insert the probe at least 2/3 of the length of the thermometer portion (B) into the food. For casseroles, place the thermometer in the center of the food. When cooking meats, insert in the center of the meatiest portion away from bone or fatty sections. For poultry, insert the probe between the inner thigh and the body of the bird.
2. Place the food on the turntable inside the oven.
3. Insert the probe plug (A) into the receptacle in the top center of the oven cavity (ceiling of the oven). Be sure the probe is securely inserted. This portion rotates as the food turns on the turntable.
4. Avoid placing the rubber cord (C) directly on or in the food.
5. Program the oven for cooking by temperature or with Sensor Temp. When the food reaches the programmed temperature, the oven will turn off automatically. Reposition the probe to check temperature. Repeat the same program. If the temperature is low, cooking will continue until the correct temperature is reached. If the temperature is correct, the oven will shut off. The time of day will reappear on the display.
6. Remove the probe plug from the receptacle before removing the food from the oven.

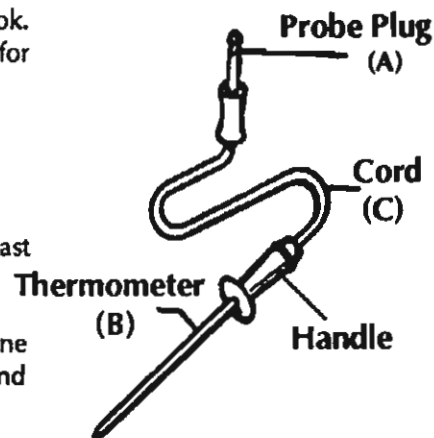

Use and Care of Temperature Probe

1. DO NOT OPERATE THE OVEN EMPTY WITH THE TEMPERATURE PROBE INSIDE. TO AVOID THIS POSSIBILITY, DO NOT LEAVE THE PROBE IN THE OVEN WHEN NOT IN USE.
2. The temperature probe should be unplugged and removed from the oven when not in use. Store the probe in a safe, convenient place outside the oven.
3. Carefully wash the temperature probe in warm sudsy water and wipe dry.
4. The temperature probe should never be allowed to touch the interior walls or door of the oven.
5. Do not use the temperature probe when using a browning dish.
6. This temperature probe is designed specifically for use in this oven. Do not substitute any other probe for this one. The probe cannot be used in other microwave ovens.
7. Avoid harsh treatment of the probe. Do not drop the probe. It is a thermometer. Handle it carefully.
8. Potholders may be needed when removing the temperature probe.
9. Do not remove the probe from the receptacle or from the food by pulling on the cord. Use the insulated handle.
10. Do not try to force the temperature probe into solidly frozen food.
11. Temperatures are displayed in the range of 90°F to 230°F. The maximum temperature which can be entered is 200°F. If a temperature more than 200°F or less than 90°F is set, **ERROR** and the incorrect temperature will appear on the display. The STOP/CLEAR pad must be touched in order to reprogram the oven.
12. Temperature readings are given for some recipes which should be cooked covered. If you wish to use the probe, cover the food with clear plastic wrap and insert the probe through the plastic wrap.
13. You will often notice a change in the temperature after stirring. This is normal and occurs in conventional cooking also.
14. Recommended cooking or serving temperatures are given for those recipes in your cookbook where cooking by temperature is appropriate. You may choose to cook by either time or temperature.

To Cook with Temperature Probe

Suppose you want to roast a chicken to 180°F at MEDIUM HIGH.

Step	Procedure	Pad Order
1.	Place probe in chicken. Insert probe plug into the receptacle in the top center of the oven cavity. Enter desired temperature.	1 8 0
2.	Touch TEMP pad to select temperature cooking.	TEMP
3.	Touch POWER LEVEL pad. Then touch pad. 7 for 70%.	P-70%
4.	Touch START pad. When food temperature is lower than 90°F, LO F will be displayed. When the internal temperature reaches 90°F, the readout will display the actual temperature of the food as it increases to 180°F. When it reaches 180°F as detected by the temperature probe, the oven will automatically shut off.	START

Your oven can be programmed to maintain any temperature from 90°F to 200°F for up to 99 minutes 99 seconds. This feature can be used to keep food warm at the desired serving temperature until you are ready to eat, or food can be simmered at a specific temperature for up to 99 minutes 99 seconds.

*If you want to maintain exactly 180°F for 20 minutes in the above example.

Step	Procedure	Pad Order
4.	After step 3, enter desired cooking or "holding" time. To maintain 180°F for 20 minutes.	2 0 0 0
5.	Touch START pad.	START

In the above example, if the actual temperature drops below 180°F during the 20 minute "holding" time, microwave energy will come on long enough to boost the temperature back up to 180°F.

NOTE: 1. If the temperature probe is not plugged in properly or is defective, TEMP indicator will flash on and off. When you touch START, TEMP will remain. **PROBE** will flash on the display, and oven will not turn on.

2. If you are in the process of cooking using the temperature probe and wish to check the temperature you have programmed, simply touch the TEMP pad. As long as your finger is touching the TEMP pad., the programmed temperature will be displayed.

To Monitor Temperature





If the temperature probe is plugged into the top center of the oven cavity and the probe is placed in water or food, the temperature of the water or food can be monitored on the readout. Touch the TEMP pad. Temperature detected by temperature probe will appear on display. (90°F to 230°F will be displayed.) To return to the time of day, touch the STOP/CLEAR pad.

Sensor Temp

Sensor Temp 1-6 automatically cooks roasts, poultry and casseroles to an exact internal doneness. The finished temperatures are already calculated.

Sensor Temp 7 is used for slow cooking. It will bring the food quickly up to temperature and maintain it for up to 4 hours.

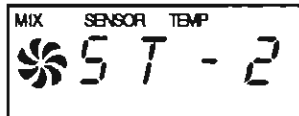
*Suppose you want to cook a beef roast to medium doneness:

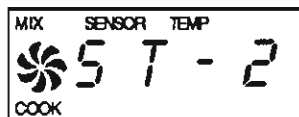
Step	Procedure	Pad Order	Display
1.	Place probe in the meat. Place meat in the oven. Insert probe plug into the receptacle in the top center of the oven cavity. Close the door. Touch SENSOR TEMP pad.		
2.	Select desired Sensor Temp setting. Touch 2 to cook roast to medium.		
3.	Touch START pad. When the internal temperature reaches 100°F, the readout will display the actual temperature of the food as it increases to 130°F. The oven will automatically shut off and COVER and STAND will be displayed repeatedly.		

Open oven door or touch STOP/CLEAR pad. The time of day will reappear on the display.

NOTE: If you touch the wrong Sensor Temp setting, retouch the correct setting.

SENSOR TEMP CHART

Place roasts and turkey breasts on broiling trivet. Place shallow glass baking dish under meat if you want to save drippings for gravy. Using small strips of aluminum foil, shield edges of roasts from beginning to assure perfect results. Foil strips should not touch probe or rack. Select Sensor Temp setting. Oven will signal when final temperature is reached. Reposition probe and reprogram. If the temperature is low, cooking will continue until temperature is reached. If the temperature is correct, the oven will shut off.

Food	Setting	Internal Temperature	Comments	Cooking Mode
Roast beef (rare)	1	120°F	Stand, covered, 10 min.	HIGH MIX 325°F
Roast beef (medium)	2	130°F	Stand, covered, 10 min.	HIGH MIX 325°F
Roast beef (well done)	3	150°F	Stand, covered, 15 min.	HIGH MIX 325°F
Roast Pork	4	170°F	Stand, covered, 10 min.	HIGH MIX 325°F
Turkey breast	5	170°F	Stand, covered, 10 min.	HIGH MIX 325°F
Casserole with cooked ingredients	6	160°F	Cover with lid or plastic wrap	MICROWAVE
Simmer (sauces, stews)	7	180°F	Hold for maximum of 4 hr.*	MICROWAVE

* If you want to simmer food for less than 4 hours, stop oven after desired simmer time.

Convection and Automatic Mix Cooking

This section of the Operation Manual gives you helpful hints for convection and combination cooking. Please consult your Sharp Carousel Convection Cookbook for more specific cooking instructions and procedures.

Recommended Utensils:

Metal turntable	Aluminum foil containers
Baking Rack	Heat resistant glass
Broiling trivet	Corning Ware®
Metal baking pans	
Ovenable paper board containers (follow manufacturer's instructions)	

Convection Cooking

During convection heating, hot air is circulated throughout the oven cavity to brown and crisp foods quickly and evenly. This oven can be programmed for ten different convection cooking temperatures for up to 99 minutes 99 seconds.

The oven should not be used without the turntable in place, and it should never be restricted so that it cannot rotate. You may remove the turntable when preheating the oven and when preparing food to be cooked directly on the turntable.

Helpful Hints:

1. Foods may be cooked either directly on the turntable or with the rack or trivet on the turntable.
2. Do not cover turntable, broiling trivet or baking rack with aluminum foil. It interferes with the flow of air that cooks the food.
3. Round pizza pans are excellent cooking vessels for many convection-only items. Choose pans that do not have extended handles.
4. Hot dogs cooked on the broiling trivet may be turned over to give an even, grilled appearance.

Automatic Mix Cooking:

This oven has two preprogrammed settings that make it easy to cook with both convection heat and microwave automatically.

With the exception of those foods that cook best by convection heating alone, most foods are well suited to mix cooking using either LOW MIX/BAKE or HIGH MIX/ROAST.

The marriage of these two cooking methods produces juicy meats, moist and tender cakes, and fine textured breads, all with just the right amount of browning and crispness.

Helpful Hints:

1. Meats may be roasted directly on the broiling trivet or in a shallow roasting pan on the trivet on the turntable.
2. Less tender cuts of beef can be roasted and tenderized using oven cooking bags.
3. When baking, check for doneness after time has elapsed. If not completely done, let stand in oven for a few minutes to complete cooking.

NOTE:

During mix baking some metal baking utensils may cause arcing when they come in contact with the turntable, oven walls or metal accessory racks. Arcing is a discharge of electricity that occurs when microwaves come in contact with metal. If arcing occurs, place a heat resistant dish (Pyrex® pie plate, glass pizza dish or dinner plate) between the pan and the turntable or trivet. If arcing occurs with other baking utensils, discontinue their use for combination cooking.

To Cook with Convection

*Suppose you want to cook at 350°F for 20 minutes.

Step	Procedure	Pad Order	Display
1.	Enter desired cooking time.	<input type="text" value="2"/> <input type="text" value="0"/> <input type="text" value="0"/> <input type="text" value="0"/>	
2.	Touch CONVECTION pad.	<input type="text" value="CONVEC"/>	
3.	Enter desired temperature.	<input type="text" value="350°F"/>	
4.	Touch START pad.	<input type="text" value="START"/>	

NOTE: If you are cooking with convection or automatic mix and you wish to check the temperature you have programmed, simply touch the CONVECTION pad. The programmed temperature will be displayed as long as the CONVECTION pad is touched.

To Cook with Automatic Mix

*Suppose you want to bake a cake for 20 minutes on LOW MIX/BAKE.

Step	Procedure	Pad Order
1.	Enter desired cooking time.	<input type="text" value="2"/> <input type="text" value="0"/> <input type="text" value="0"/> <input type="text" value="0"/>
2.	Touch LOW MIX/BAKE pad.	<input type="text" value="LOW MIX
BAKE"/>
3.	Touch START pad.	<input type="text" value="START"/>

NOTE: To cook on HIGH MIX/ROAST setting, use the above procedure, touching HIGH MIX/ROAST pad in Step 2.







*Suppose you want to bake a double crust pie for 30 minutes on HIGH MIX/ROAST at 400°F (change temperature).

Step	Procedure	Pad Order
1.	Enter desired cooking time.	<input type="text" value="3"/> <input type="text" value="0"/> <input type="text" value="0"/> <input type="text" value="0"/>
2.	Touch HIGH MIX/ROAST pad.	<input type="text" value="HIGH MIX
ROAST"/>
3.	Enter desired temperature.	<input type="text" value="400°F"/>
4.	Touch START pad.	<input type="text" value="START"/>

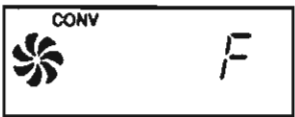
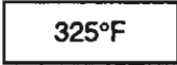
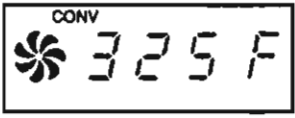
To Preheat and Cook with Convection

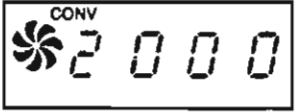
Your oven can be programmed to combine preheating and convection cooking or preheating and automatic mix cooking operations. You can preheat at the same temperature as the convection temperature or the automatic mix temperature or change it to a higher or lower temperature.

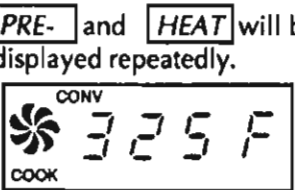
*Suppose you want to preheat the oven to 325°F then cook for 20 minutes at 325°F.

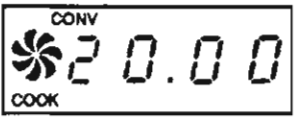
Step	Procedure	Pad Order	Display
1.	Touch CONVECTION pad.		
2.	Touch desired preheat temperature pad.		
3.	Enter desired cooking time.		
4.	Touch START pad. When the oven reaches the programmed temperature, the Convection Fan Symbol will stop flashing and begin rotating and an audible signal will sound 4 times, and the temperature will be displayed.*		
5.	Open door. Place food in oven. Close door. Touch START pad.		

* At this point the oven is preheated. If the oven door is not opened, the oven will begin temperature holding operation. The oven will automatically hold at the preheat temperature for 15 minutes. After this time has elapsed, an audible signal will sound and the oven will turn off. The time of day will reappear on the display.

NOTE: If you are in the process of preheating and wish to check the actual oven temperature, follow Steps 1 through 3 above, then touch the CONVECTION pad and the desired cooking temperature pad. The cooking temperature will appear on the display. Continue with Steps 4 and 5.

To Preheat and Cook with Automatic Mix

*Suppose you want to preheat the oven to 325°F and bake a pie for 20 minutes on HIGH MIX/ROAST.

See "To Preheat and Cook with Convection" above. Touch HIGH MIX/ROAST pad after step 3. Continue with steps 4 and 5.

NOTE: If you wish to preheat and cook at a different automatic mix cooking temperature, follow "To Preheat and Cook with Automatic Mix", after touching HIGH MIX/ROAST pad, touch the desired cooking temperature pad. The cooking temperature will appear on the display. Continue with steps 4 and 5.

To Sequence Cook with Automatic Mix









Your oven can be programmed for up to four sequences for cooking. First touch time and then cooking mode. If HIGH MIX or LOW MIX are a desired cooking mode, first touch time, then HIGH MIX or LOW MIX and then a temperature pad.

Convection Cooking Using Temperature Probe

The Temperature Probe can be used also during convection cooking or automatic mix cooking to cook food to an internal temperature of 90°F to 200°F.

When the desired food temperature has been reached, the oven will turn off automatically.

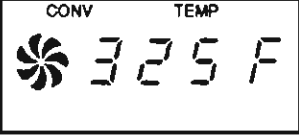
*Suppose you want to cook a roast at 325°F (convection temperature) until it reaches 150°F (food temperature).

Step	Procedure	Pad Order	Display
1.	Place probe in meat. Insert probe plug into the receptacle in the top center of the oven cavity. Touch number pads for desired food temperature.		
2.	Touch TEMP pad.		
3.	Touch CONVECTION pad.		
4.	Touch convection temperature for desired oven temperature. (Ex. 325°F)		
5.	Touch START pad. When the internal temperature reaches 90°F, the readout will display the actual temperature to the food as it increases to 150°F.		When food temperature is lower than 90°F: 

Automatic Mix Cooking Using Temperature Probe

*Suppose you want to cook a roast on HIGH MIX/ROAST until it reaches 150°F.

See "Convection Cooking Using Temperature Probe" above. Touch HIGH MIX/ROAST instead of CONVECTION pad in Step 3, eliminate Step 4, and touch START.

Convection and Microwave Cooking

Your oven can be programmed to combine convection and microwave cooking operations.

*Suppose you want to bake chicken pieces at 350°F for 15 minutes and then cook at 50% power (Med.) for 3 minutes.

Step	Procedure	Pad Order	Display
1.	Enter desired convection cooking time.	<input type="text" value="1"/> <input type="text" value="5"/> <input type="text" value="0"/> <input type="text" value="0"/>	
2.	Touch CONVECTION pad.	<input type="text" value="CONVEC"/>	
3.	Enter desired convection temperature.	<input type="text" value="350°F"/>	
4.	Enter desired microwave cooking control setting.	<input type="text" value="3"/> <input type="text" value="0"/> <input type="text" value="0"/>	
5.	Select Power Level setting.	<input type="text" value="50%"/>	
6.	Touch START pad.	<input type="text" value="START"/>	<p>The timer begins to count down to zero. When it reaches zero, the display changes:</p> <p>The timer counts down the microwave time to zero.</p>

Broiling

Preheating is automatic when the BROIL setting is used. Only actual cooking time is entered; the oven signals when it is preheated to 450°F. Use broil for steaks, chops, chicken pieces and many other foods. See your Sharp Carousel Convection Cookbook for suggestions and cooking time.

*Suppose you want to broil a steak for 15 minutes.

Step	Procedure	Pad Order	Display
1.	Enter maximum broiling time.	<input type="text" value="1"/> <input type="text" value="5"/> <input type="text" value="0"/> <input type="text" value="0"/>	
2.	Touch BROIL pad. No food in oven.	<input type="button" value="BROIL"/>	
3.	Touch START pad. When oven temperature reaches 450°F, the Convection Fan Symbol will stop flashing and begin rotating. An audible signal will sound 4 times.*	<input type="button" value="START"/>	
4.	Open door. Place food in oven. Close door. Touch START pad.	<input type="button" value="START"/>	





* Oven will maintain 450°F for 15 minutes after signal sounds and Convection Fan Symbol begins to rotate. If the door is not opened (food placed in oven) within 15 minutes, The oven will automatically cut off.

Although timer is set for the maximum broiling time as directed in Step 1, check food at minimum time recommended in the chart. This step will eliminate the need to completely reprogram the oven if additional time is needed. Simply close the oven door and touch START to continue.

Slow Cook

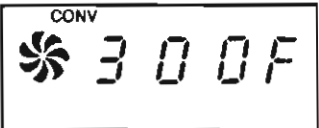
The SLOW COOK setting is preset for 300°F for 4 hours. It is designed for foods which cook longer than 99 minutes 99 seconds at 300°F or less. Foods such as baked beans or stews are best cooked slowly at low temperatures. The SLOW COOK feature expands the length of cooking time to a maximum of 4 hours at 300°F or lower. It adds to the overall versatility of your new Convection Microwave oven. When using this setting, no cooking time is entered; you will need to time the food manually.

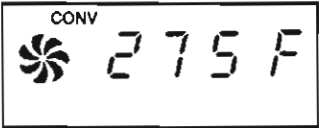
*Suppose you want to change oven temperature from 300°F to 275°F.

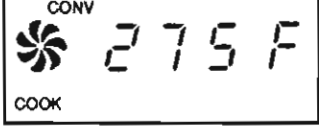
Step	Procedure	Pad Order	Display
1.	Touch SLOW COOK pad.		
2.	Enter desired oven temperature if you want to change from 300°F.		
3.	Touch START pad.		 Convection Fan Symbol will begin to rotate.

After 4 hours an audible signal will sound. All indicators will go out. The time of day will appear on the display. If the oven door is opened or the STOP/CLEAR pad is touched during the SLOW COOK cycle, the program will be cancelled and the oven will turn off. If you need to check food, open the oven door and check or stir. After closing the door, touch SLOW COOK, lower temperature if needed, and touch START to reactivate the oven. When changing SLOW COOK temperature, a temperature above 300°F cannot be entered.

Minute Plus

Minute Plus allows you to cook for a minute at HIGH by simply touching the Minute Plus pad. You can also extend cooking time in multiples of 1 minute by repeatedly touching the Minute Plus pad during the cooking program of microwave, convection or combination cooking.

*Suppose you want to heat a cup of soup for one minute.

Step	Procedure	Pad Order
1.	Touch MINUTE PLUS pad.	

- NOTE:
1. Minute Plus can only be entered within 1 minute after cooking, closing the door, touching STOP/CLEAR pad or during cooking. Minute Plus cannot be used to start the oven if any program is on the display.
 2. The cooking time can be increased in multiples of 1 minute by repeatedly touching the Minute Plus pad during a cooking program of microwave, convection or combination cooking and during maintaining temperature with the probe. Minute Plus cannot be used with Easy Reheat, Sensor Temp, CompuDefrost, Compu Cook and Slow Cook.

CompuCook

CompuCook will automatically compute the oven temperature, microwave power and cooking time for baking, roasting, and broiling. It is based on specific foods and the quantity or weight of the food.

To Cook With CompuCook

*Suppose you want to use CompuCook to cook a 6.95 pound chicken.

Step	Procedure	Pad Order	Display
1.	Touch COMPU COOK pad.	COMPU COOK	FOOD COMPU
2.	Select food category for CompuCook. Touch 3 to cook Roast Chicken.	3	MIX COMPU CC - 3 Lbs. Lbs. will flash on and off.
3.	Touch number pads to enter weight.	7 0	MIX COMPU 7 . 0 Lbs. Lbs. stops flashing.
4.	Touch the START pad.	START	MIX COMPU COOK 57 . 36 Convection fan symbol will rotate.

After cooking, **COVER** and **STAND** will be displayed repeatedly.

Open oven door or touch STOP/CLEAR pad. The time of day will reappear on the display.

If the cooking time for any CompuCook food is more than one hour, 1H and the minutes will appear on the display. When the countdown reaches one hour (60 minutes), minutes and seconds will appear on the display and continue to count down.

- NOTE:
- Use foods listed in the CompuCook Section of the control panel.
 - CompuCook works with foods at normal storage temperature. For example, chicken would be at refrigerator temperature and cakes and bread would be at room temperature.
 - Foods weighing more or less than the quantity listed in the chart should be cooked following guidelines in the cookbook. If you enter an incorrect quantity and touch the START pad, **ERROR** and the incorrect quantity will appear alternately on the display.
 - The weight or quantity can be entered for each CompuCook Setting. The unit, pounds (Lbs.) or quantity (No.), will appear on the display. For example, turkey would be calculated in pounds and hamburger patties would be quantity.
 - Pounds must be rounded off to the nearest tenth of a pound (Example: 5.45 lbs. should be rounded off to 5.5 lbs.)
 - Preheat is automatic with CC-1 (Hamburgers, broiled) and CC-2 (chicken, broiled). When the oven reaches the desired temperature, an audible signal will sound 4 times; place the food in the oven and touch START.
 - All foods can be seasoned, as desired, before cooking begins.
 - If the door is opened during CompuCook, shut door and touch START pad to resume cooking.

CompuCook Chart

Food	Compu Cook Setting	Amount	Unit	Procedure	Comments
Hamburgers, broiled	1	2-8 pieces	Number of patties	Season, as desired. Place on broiling trivet.	Patties should be 1/4 lb. each, 1/2-inch thick.
Chicken, broiled	2	0.5 - 3.5 lbs.	Pounds	Season, as desired. Place on broiling trivet.	Chicken next to bone should no longer be pink.
Chicken, roast	3	2.5 - 7.5 lbs.	Pounds	Season, as desired. Place on broiling trivet.	Let stand, covered with foil, 10 to 15 minutes.
Turkey	4	6.5 - 9.0 lbs.	Pounds	Season, as desired. If stuffed, add 1-2 lbs. for stuffing depending on size of bird. Place on broiling trivet.	Let stand, covered with foil, 10 - 15 minutes.
Cake layers	5	1 - 2 layers	Number of layers	One or two 9-inch round metal cake pans, greased.	Cool 10 minutes in pan on wire rack; remove from pan. Complete cooling on wire rack.
Bread loaves	6	1 - 2 loaves	Number of loaves	One or two 9 x 5 metal loaf pans, greased.	Remove from pans immediately. Cool on wire racks.

Auto Start

If you wish to program your oven to begin cooking automatically at a designated time of day, follow this procedure:

*Suppose you want to start cooking a stew for 20 minutes on MEDIUM at 4:30 this afternoon. Before setting, check to make sure the clock is showing the correct time of day.

Step	Procedure	Pad Order
1.	Enter the desired start time.	<div style="display: inline-block; border: 1px solid black; padding: 2px 5px;">4</div> <div style="display: inline-block; border: 1px solid black; padding: 2px 5px;">3</div> <div style="display: inline-block; border: 1px solid black; padding: 2px 5px;">0</div>
2.	Touch AUTO START/CLOCK pad.	<div style="border: 1px solid black; padding: 5px; display: inline-block;"> AUTO START CLOCK </div>
3.	Enter desired cooking program.	<div style="display: inline-block; border: 1px solid black; padding: 2px 5px;">2</div> <div style="display: inline-block; border: 1px solid black; padding: 2px 5px;">0</div> <div style="display: inline-block; border: 1px solid black; padding: 2px 5px;">0</div> <div style="display: inline-block; border: 1px solid black; padding: 2px 5px;">0</div> <div style="border: 1px solid black; padding: 5px; display: inline-block;">MED</div>
4.	Touch START pad.	<div style="border: 1px solid black; padding: 5px; display: inline-block;">START</div>

NOTE: The Auto Start feature can be used for any of the programs except CompuDefrost and Minute Plus. Once you have correctly programmed the oven for Auto Start, the correct time of day (not the AutoStart time) will appear on the display. To check the programmed Auto Start time, touch the AUTOSTART/CLOCK pad. The programmed Auto Start time will appear as long as your finger is touching the pad. Checking the Auto Start time will not interfere with the operation of the oven. To cancel Auto Start, simply touch the STOP/CLEAR pad twice.

Sensor Cooking

Sharp's Sensor is a semi-conductor device that detects the vapor (moisture and humidity) emitted from food as it heats. The Sensor adjusts the cooking times and variable power for various foods and quantities. It takes the guess work out of microwave cooking.

Using Sensor Settings:

1. Room temperature should not exceed 95°F.
2. Exhaust vents are provided on the back of the unit for proper cooling and air flow in the cavity. To permit adequate ventilation, be sure to install the unit so as not to block these vents. There should be some space for air circulation.
3. Be sure the exterior of the cooking container and the interior of the oven are dry. Wipe off any moisture with a dry cloth or paper towel.
4. During the first part of Sensor cooking, **RE-**, **HEAT**, or **POP**, **CORN** or **SC-** and the Sensor setting number will appear on display. Do not open the oven door or touch STOP/CLEAR during this part of the cooking cycle. The measurement of vapor will be interrupted. If this occurs, **ERROR** will appear and sensor cooking will be interrupted. To continue cooking, touch the STOP/CLEAR pad and select cooking time and variable power. Door may be opened when remaining cooking time appears on display. At this time, you may stir or season food, as desired.
5. Check food for doneness after cooking with sensor settings. If additional time is needed, continue to cook with variable power and time.
6. If the sensor has not detected vapor by about four minutes when using the popcorn setting, the oven will shut off. With the other sensor settings if, after 33 minutes, the sensor has not detected the vapor of the food, **ERROR** will appear and the oven will shut off.

Selecting Foods:

1. The Sensor works with foods at normal storage temperature. For example, bacon would be at refrigerator temperature and canned soup at room temperature.
2. Foods weighing less than 3 ounces should be cooked by time and variable power.

Covering Foods:

Some foods work best when covered. Use the cover recommended in the chart or recipe for these foods.

1. Casserole lid
2. Plastic wrap
Use plastic wrap recommended for microwave cooking.
Cover dish loosely; fold excess wrap over side of dish. Plastic wrap should not touch food.
Do not create an air tight seal.
3. Paper towel
Use paper towels to absorb excess fat when cooking bacon. Line paper plate with paper towels and cover bacon with additional paper towels.
4. Wax paper
Cover dish completely; fold excess wrap under dish to secure. If dish is wider than paper, overlap two pieces at least one inch to cover.

Be careful when removing any covering to allow steam to escape away from you.



1. Casserole lid



2. Plastic wrap

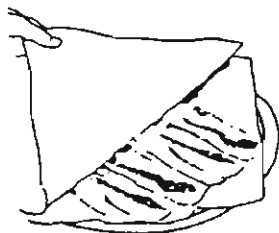

3. Paper towel



4. Wax Paper

Reheat Sensor

You can reheat many foods by touching just one pad. You don't need to calculate cooking time or power level.

* Suppose you want to reheat canned chili.

Procedure	Display
<p>REHEAT</p> <p>1 Touch REHEAT pad.</p> <p>When sensor detects the vapor emitted from the food, remainder of cooking time will appear (ex. remainder of cooking time is 1 min. 30 sec.).</p>	<p>RE- and HEAT will be displayed repeatedly.</p>  <p>After cooking, COVER and STAND played repeatedly.</p>

Open oven door or touch STOP/CLEAR pad. The time of day will reappear on the display.

NOTE: Reheat Sensor can only be programmed within 1 minute after cooking, closing the door or touching the STOP/CLEAR pad.

Popcorn Sensor

* Suppose you want to cook one popcorn package.

Procedure	Display
<p>POPCORN</p> <p>1 Touch POPCORN pad.</p> <p>When sensor detects the vapor emitted from the food, remainder of cooking time will appear (ex. remainder of cooking time is 30 sec.).</p>	<p>POP and CORN will be displayed repeatedly. Place bag in center of inverted glass pie plate.</p> 

NOTE: Popcorn sensor can only be programmed within 1 minute after cooking, closing the door or touching the STOP/CLEAR pad.

Reheat Sensor Chart

Food	Amount	Procedure
Dinner plate	4 or more oz.	Cover with wax paper. Stand, covered 5 min.
Leftovers	4 or more oz.	Casserole with lid or plastic wrap. Stand, covered, 5 min.
Canned entrees and vegetables	4 to 16 oz.	Casserole with lid or plastic wrap. Stir before standing time. Stand, covered, 5 min.

Pizza Sensor Chart

Food	Amount	Procedure
Pizza, Package	Only 1 package at a time	Follow package directions on how to place in oven. Pizza is usually placed on part of

To Cook with Sensor

There are ten different Sensor settings to cook your favorite foods.

* Suppose you want to cook baked potatoes.

Procedure	Display
<p>SENSOR COOK</p> <p>1 Touch SENSOR COOK pad.</p>	<p>SENSOR</p> <p>F 0 0 0</p>
<p>2</p> <p>2 Select desired Sensor setting. Touch 2 to cook baked potatoes.</p>	<p>SENSOR</p> <p>5 C - 2</p>
<p>START</p> <p>Touch START pad.</p> <p>3 When sensor detects the vapor emitted from the food, remainder of cooking time will appear (ex. remainder of cooking time is 3 mins. 20 sec.).</p>	<p>SENSOR</p> <p>5 C - 2</p> <p>COOK</p> <p>SENSOR</p> <p>3 . 2 0</p> <p>COOK</p> <p>After cooking, COVER and STAND will be displayed repeatedly.</p>

Open oven door or touch STOP/CLEAR pad. The time of day will reappear on the display.

NOTE: If you touch the wrong Sensor setting, retouch the correct setting. Selected setting will appear on the display.

Pizza Sensor

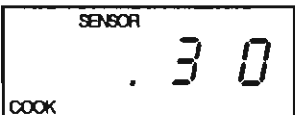
Procedure	Display
<p>PIZZA</p> <p>1 Touch PIZZA pad.</p> <p>When sensor detects the vapor emitted from the food, remainder of cooking time will appear (ex. remainder of cooking time is 30 sec.).</p>	<p>SENSOR will be displayed repeatedly.</p> 

Popcorn Sensor Chart

Food	Amount	Procedure
Popcorn, package	Only 1 package at a time	Use only popcorn packages for microwave oven. Place bag in center of inverted glass pie plate. Do not try to pop unpoped kernels.

SENSOR COOK CHART

Food	Sensor Cook Setting	Amount	Procedure	Comments
Potatoes				
Baked potatoes	1	1 to 6 med.	Prick; place on turntable.	Stand, wrapped in foil, 5-10 min.
Sweet potatoes		1 to 6 med.	Prick; place on turntable.	Stand, wrapped in foil, 3 min.
Fresh vegetables, soft	2			
Broccoli		1/2-2 lbs.	Wash and place in casserole. Add 2 tablespoons of water. Cover with lid for tender vegetables. Use plastic wrap for tender crisp vegetables. Stir before standing if possible.	Stand, covered 3-5 min.
Brussel sprouts		1/2-2 lbs.		
Cabbage		1/2-3 lbs.		
Cauliflower (flowerets)		1/2-2 cups		
Cauliflower (whole)		1 med.		
Spinach		1/4-1 lb.		
Zucchini		1/2-2 cups		
Baked apples	2	2 to 4 med.	Peel around top and remove core. Place sugar or cinnamon candies in core. Place in glass pie plate. Cover with plastic wrap.	
Fresh vegetables, hard	3			
Carrots, sliced		1/2-2 cups	Place in casserole. Add 1/4 to 1/2 cup of water. Cover with lid for tender vegetables. Use plastic wrap cover for tender crisp vegetables. Stir before standing, if possible.	Stand, covered, 5 min.
Corn on cob		2-4 cups		
Green beans		1/2-2 cups		
Winter squash, diced halves		1/2-2 cups 2		
Sauté vegetables	4	1/2 to 2 cups	2 to 4 cup measure. Diced vegetables, 1 to 2 tablespoons butter. Cover with plastic wrap. Use a large container to cook mushrooms. Stir before standing.	Stand, covered, 5 min.
Frozen vegetables	5	1/4 to 1 lb.	Break up before cooking. Place in casserole. Cover with lid or plastic wrap. Stir before standing, if possible.	Stand, covered, 3-5 min.
Soup, clear	6	8-20 oz.	Use mug, bowl or casserole. Cover with lid or plastic wrap. Stir before standing.	Stand, covered, 3-5 min.
Soup, cream	7	8-20 oz.	Use mug, bowl or casserole. Cover with lid or plastic wrap. Stir before standing.	Stand, covered, 3-5 min.
Hot dog with bun	8	1 to 2	Wrap in two paper towels.	
Bacon, slices	9	2 to 6 slices	Place bacon on paper plate, lined with paper towel. Bacon should not extend over rim of plate. Cover with paper towel. Put paper plate upside down on turntable. Place plate of bacon on top of overturned plate.	
Fish, Seafood	0			
Fillet, Steak, Shrimp, Scallop, fresh or frozen, thawed		1/4 to 1 lb.	Arrange in ring around shallow glass dish. (Roll fillet with edges underneath.) Cover with plastic wrap.	Stand, covered, 3 min.
Clams, fresh		1/4 to 1 lb.	Place in plastic bag. Secure end. Slit bag with knife.	Stand, covered, 3 min.

Sensor Cook Recipes

Cranberry Fluff

- | | |
|---|---|
| 2 cups fresh cranberries | 1/2 pint whipping cream, whipped or |
| 1 cup water | 1 carton (8 ounces) non-dairy whipped topping |
| 3/4 cup sugar | |
| 1 carton (3 ounces) orange-flavored gelatin | |

Makes 6 to 8 servings

1. Combine cranberries, water and sugar in a 2-quart casserole. Cover with waxed paper. Microwave using Sensor Cook for Soup, Clear. Drain cranberries and reserve liquid.
2. Add enough hot water to reserved liquid to make 2 cups. Stir the gelatin into hot liquid until it dissolves. Cover with waxed paper. Microwave using Sensor Cook for Soup, Clear.
3. Add berries and cool. Refrigerate until thickened. Fold whipped cream into cooled cranberry mixture. Spoon into serving dishes and garnish with extra whipped cream. Refrigerate until ready to serve.

Curry Vegetable Chowder

- | | |
|--|-------------------------------------|
| 6 slices bacon | 3/4 teaspoon salt |
| 1 can (10-3/4 ounces) chicken broth | 1/2 teaspoon curry powder |
| 3 medium potatoes, finely diced (about 2 cups) | 1/8 teaspoon pepper |
| 2 carrots, shredded (about 1 cup) | 1 can (12 ounces) evaporated milk |
| 1 small onion, chopped (about 1/2 cup) | 2 tablespoons chopped fresh parsley |

Makes 4 servings

1. Layer 2 paper towels on a microwave safe plate. Arrange bacon on the towels. Cover with another paper towel. Microwave using Sensor Cook for Bacon. Crumble and reserve bacon.
2. Combine chicken broth, vegetables and seasonings in 4-quart casserole. Cover with vented plastic wrap. Microwave using Sensor Cook for Baked Potatoes. Vegetables should be tender.
3. Stir in evaporated milk. Recover with vented plastic wrap. Microwave using Sensor Cook for Soup, Cream. Stir in parsley. Let stand covered, 5 minutes.
4. Top each serving with crumbled bacon.

Flounder Fillet with Vegetables

- | | |
|-----------------------------------|--|
| 1/2 green pepper, diced | 1 pound flounder fillet, fresh or frozen, thawed |
| 1 small onion | 1/8 teaspoon pepper |
| 1 medium potato, peeled and diced | 1/8 teaspoon paprika |
| 1 clove garlic, minced | 1/4 teaspoon salt |
| 2 tablespoons margarine or butter | 1/4 teaspoon thyme leaves |
| 1 medium tomato, chopped | parsley flakes |

Makes 4 servings

1. Combine green pepper, onion, potato, garlic and margarine in 2-cup measuring cup. Cover with vented plastic wrap. Microwave using Sensor Cook for Fresh Vegetables, Soft. Stir in tomato.
2. Arrange fish in a ring around the outside of a 12-inch round glass utility dish. Pour vegetables over fish. Sprinkle with pepper, paprika, salt and thyme. Cover well with vented plastic wrap. Microwave using Sensor Cook for Fish and Seafood. Let stand 2 minutes. Top with parsley and serve.

Glazed Apple Slices

- | | |
|-----------------------------------|--|
| 1/4 cup packed brown sugar | 3/4 cup orange juice |
| 3 tablespoons margarine or butter | 1 tablespoon cornstarch |
| 2 tablespoons apricot preserves | 4 baking apples (about 1-1/2 pounds), peeled and sliced into 8 pieces each |
| 1/2 teaspoon ground nutmeg | 3 tablespoons chopped green pistachios |
| 1/4 teaspoon salt | |
| 1/2 cup sugar | |

Makes 6 to 8 servings

1. Combine brown sugar, margarine and apricot preserves in a small bowl. Microwave at HIGH (100%) until margarine melts and preserves soften, 45 seconds to 1 minute. Stir in nutmeg, salt, sugar, orange juice and cornstarch. Microwave at HIGH (100%) until thickened, 4 to 6 minutes, stirring several times.
2. Arrange apple slices in a large microwave serving dish. Spread hot sauce over apples. Cover well with vented plastic wrap. Microwave using Sensor Cook for Fresh Vegetables, Soft. Allow to cool 5 minutes before serving.
3. Sprinkle with pistachios. Serve alone or over vanilla ice cream or sponge cake.

Mexican Seasoned Potatoes

- | | |
|--|-----------------------------|
| 4 medium baking potatoes (8 ounces each) | 1/2 teaspoon oregano leaves |
| 1/4 cup olive oil | 1/4 teaspoon ground cumin |
| 1 tablespoon instant minced onion | 1/2 teaspoon salt |
| 1/2 teaspoon chili powder | |

Makes 6 to 8 servings

1. Cut each potato lengthwise into 4 equal wedges. Place potato wedges into 10-inch square casserole. Toss potatoes with oil to coat well.
2. In small bowl, combine remaining ingredients. Sprinkle over potatoes.
3. Cover potatoes with waxed paper. Microwave using Sensor Cook for Baked Potatoes. Rearrange potatoes when time appears on display. Let stand covered 5 minutes.

Microwaved Fresh Pumpkin

- 1 Pie Pumpkin or Sugar Pumpkin

1. Wash and cut pumpkin into quarters. Remove seeds and strings. Place in a glass pie plate. Cover well with vented plastic wrap.
2. Microwave using Sensor Cook for Fresh Vegetables, Hard. Allow to stand covered 5 minutes.
3. Scrape the pulp from the shell. Strain off excess liquid from cooked pumpkin. Place pumpkin into food processor or blender and process until smooth. Use in your favorite recipes.

Shrimp Scampi

- | | |
|------------------------------------|--|
| 1/2 cup margarine or butter | 1/2 teaspoon salt |
| 1 tablespoon snipped fresh parsley | 1 pound large raw shrimp, shelled and deveined |
| 2 tablespoons lemon juice | paprika |
| 1 large clove garlic, minced | |

Makes 4 servings

1. Place margarine in 2-cup measuring cup. Microwave at HIGH (100%) until melted, 1 to 1-1/2 minutes. Stir in parsley, lemon juice, garlic and salt.
2. Arrange shrimp in a large glass pie plate. Pour seasoned butter over shrimp. Cover well with vented plastic wrap. Microwave using Sensor Cook for Fish and Seafood. Shrimp should be pink and opaque.
3. Sprinkle with paprika and serve over hot cooked rice.

Spiced Carrots

- | | |
|---|-------------------------------|
| 3 cups sliced carrots, 1/4 inch thick | 1/2 cup sugar |
| 1/2 cup chopped green pepper, 1 inch cubes | 2 teaspoons vinegar |
| 1/4 cup finely chopped onion | 1 teaspoon soy sauce |
| 3 tablespoons water | 1/2 teaspoon salt |
| 1 can (7-3/4 ounces) semi-condensed tomato soup | 1/2 teaspoon prepared mustard |
| | 1/8 teaspoon pepper |

Makes 6 to 8 servings

1. In a 1-1/2-quart casserole, combine carrots, green pepper, onion and water. Cover with lid. Microwave using Sensor Cook for Fresh Vegetables, Hard. Carrots should be tender crisp. Drain.
2. Stir in remaining ingredients. Cover and microwave using Reheat.

CAUTIOUS REMINDERS

1. Do not operate the oven empty in the microwave mode. Either food or water should always be in the oven during operation to absorb microwave energy.
2. Limit use of metal to those specific examples given in the utensil section of your cookbook. Generally, metal should not be used during operations of microwave mode only. Metal utensils can be used for convection and combination cooking.

Aluminum foil can be used for shielding to prevent overcooking or overdefrosting. Pieces should be small and smooth. Never allow to touch oven wall or door.

3. Do not cook eggs in the shell. Pressure will build up inside the shell and it will explode. Do not reheat cooked eggs unless they are scrambled or chopped. Puncture the egg yoke before cooking eggs.
4. Avoid canning in the microwave oven; harmful bacteria may not be destroyed.
5. Do not heat oil or fat for deep frying.
6. Pierce the "skin" of potatoes, whole squash, apples, or any fruit or vegetable with a skin covering before cooking.
7. Popcorn may be cooked in a special microwave popcorn popper. Use popcorn sensor or follow package directions. Follow popper manufacturer's instructions carefully. Microwave popped corn produces a lower yield than conventional popping; there will be a number of unpopped kernels. Do not use oil unless specified by the manufacturer.

Popcorn bagged especially for the microwave oven can also be used. Follow package directions carefully and never exceed the suggested times, usually five minutes. Elevate bag on an inverted glass pie plate. When popping slows to one or two seconds between pops, remove from the oven. Do not try to re-pop unpopped kernels.

Never use a regular bag or glass utensil for popping corn.

8. Do not use paper towels, plates, or other utensils made from recycled paper for microwave cooking. Recycled paper products may contain impurities which could cause the paper to ignite during microwave cooking.
9. Do not use plastic or styrofoam utensils for microwave cooking if the oven is hot from convection cooking. The utensils may melt.
10. Unlike microwave-only ovens, all convection microwave ovens have the tendency to become hot on the cabinet and oven door, as do conventional ovens and convection-only ovens. Be careful when touching parts other than the control panel during or immediately following convection cooking.

CONDENSATION

Occasionally some foods will cause the oven to "sweat." The humidity and moisture in food will influence the amount of moisture in the oven. Generally, covered foods will not cause as much condensation as uncovered foods. Be sure the vents are not blocked.

Condensation is a normal part of microwave cooking.

The door seal is designed to prevent leakage of microwave energy during cooking. The door seal does not need to be airtight in order to accomplish this. Occasionally moisture may appear around the oven door. You may be able to see some small areas of light or feel air movement around the oven door. None of these situations are abnormal or necessarily indicate the oven is leaking microwave energy.

CLEANING AND CARE

Exterior

The outside surface is precoated metal and plastic. Clean the outside with mild soap and water; rinse and dry with a soft cloth. Do not use any type of household or abrasive cleaner.

Interior

The oven walls, ceiling, and floor are stainless steel. For easy cleaning, wipe up any splatters or spills with a soft, damp cloth or sponge after each use or clean with mild detergent and water.

For heavier soil, use a mild cleaner such as Soft Scrub[®] or Bon Ami[®] following manufacturer's instructions. Commercial oven cleaner, preferably the brush-on type can be used following manufacturer's instructions. Apply to stainless walls, floor, ceiling or turntable only. Do not use spray-on oven cleaner, it may damage internal parts. Plastic or nylon scouring sponges or pads recommended for use on Teflon^{*} and Silverstone^{*} can be used on the oven walls, ceiling or turntable. Be sure to rinse cavity with a damp cloth or sponge after cleaning to remove completely all cleaner residue. Dry with a soft cloth.

Do not use harsh abrasives.

* DuPont's registered trademark.

Turntable/Turntable Support:

The turntable and turntable support can be removed for easy cleaning. Wash the turntable and turntable support in mild, sudsy water; for stubborn stains, use a mild cleanser and scouring sponge as described above. The turntable and turntable support are dishwasher-proof.

Foods with high acidity, such as tomatoes and lemons, will cause the porcelain enamel turntable to discolor. Do not cook highly acidic foods directly on the turntable; if spills occur, wipe up immediately.

The turntable motor shaft is not sealed, so excess water or spills should not be allowed to stand in this area.

Door:

When cleaning surfaces of door and oven that come together on closing the door, use only mild, non-abrasive soaps or detergents applied with sponge or soft cloth.

Touch Control Panel:

Care should be taken in cleaning the touch control panel. If the control panel becomes soiled, open the oven door before cleaning. This will inactivate the control panel. Wipe the panel with a cloth dampened slightly with water only and dry with a soft cloth. Do not scrub or use any sort of chemical cleansers.

Grease Filters:

Filters should be cleaned at least once a month. Never operate your hood without the filters in place.

1. Pull the tab toward the front of the oven, down slightly and remove the filter. Repeat for other filter.
2. Soak the filters in a sink or dish pan filled with hot water and detergent.
DO NOT use ammonia or other alkali; they will react with the filter material and darken it.
3. Agitate and scrub with a brush to remove embedded dirt.
4. Rinse thoroughly and shake dry.
5. Replace by fitting the filter back into the opening. Push back and up into place.

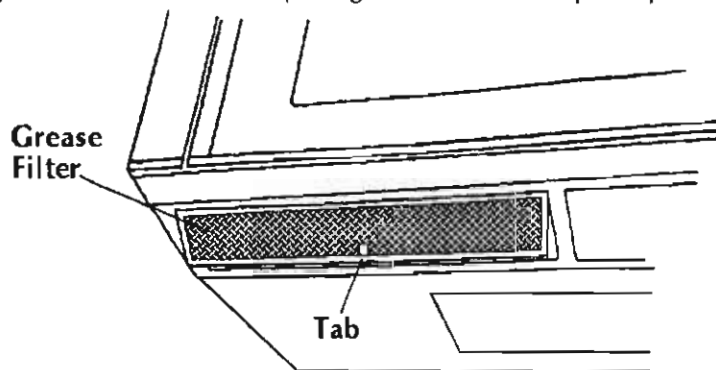

Hood Lamps:

1. To replace hood lamps, first disconnect power to the oven at the circuit breaker panel or by unplugging.
2. Push the cover by hand and slide it toward the back, and open the front side. (See illustration.)
3. Replace only with Sharp Part Number **RLMPTA037WRE0** available from a Sharp Service Station or equivalent 40 watt bulb available at most hardware stores or lighting centers. **DO NOT USE A BULB LARGER THAN 40 WATTS.**

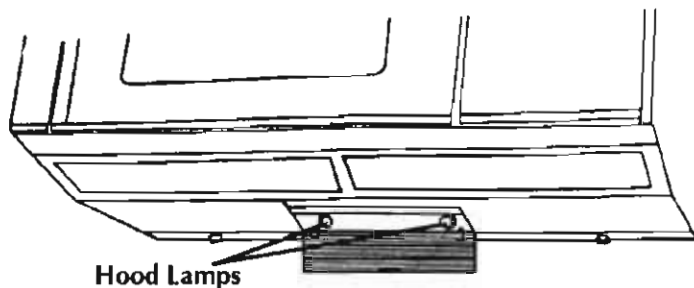

4. Slide cover back into place. The glass covering the lamps may become hot. Do not touch the glass while hood lamps are in use. Do not use hood lamps for long term use.

Charcoal Filter Kit:

Charcoal filter kit, Sharp Part Number **RK-210** is used for non-vented, recirculated installation. The filter should be changed every 6 to 12 months depending on use.

1. Disconnect power to the oven at the circuit breaker panel or by unplugging. (See illustration below.)
2. Remove louver mounting screw from top center location on top of cabinet.
3. Push **DOWN** at two (2) positions (A) and **UP** at position (B) to unhook louver from unit and remove.
4. Change the charcoal filter.
5. Snap louver back in place and replace the screw.

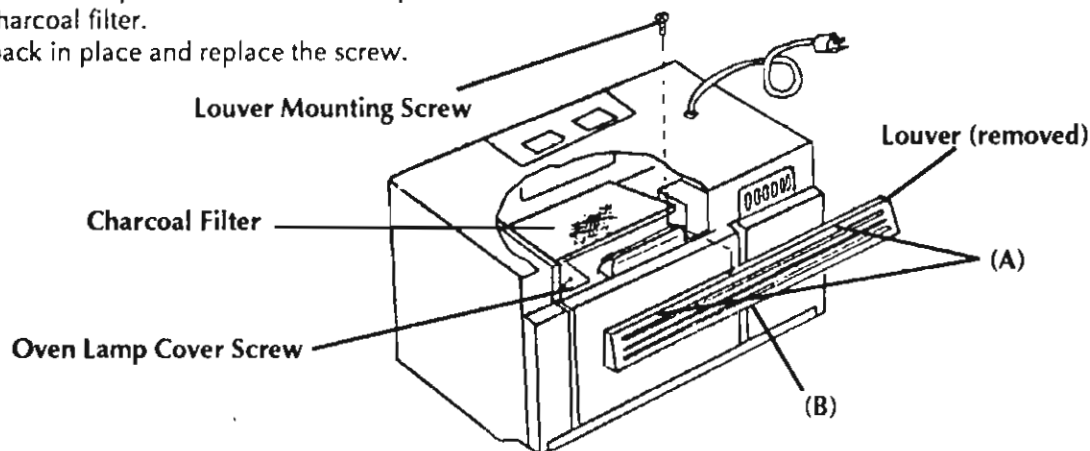

Oven Lamp:

Remove the louver per instructions 1 - 3 above and charcoal filter, if used.

4. Remove and save one Phillips head screw from oven lamp cover.
5. Remove old lamp and replace only with Sharp Part Number **RLMPTA036WRE0** available from Sharp Service Station or equivalent 30 watt lamp available from most hardware stores and lighting centers. **DO NOT USE BULB LARGER THAN 30 WATTS.**
6. Replace the oven lamp cover, Phillips head screw and charcoal filter (if used); snap louver back into place and replace louver mounting screw.

Hood:

The hood fan will automatically start when heat rises from range surface units. This protects the oven from excessive temperature rise. Fan will stay on until temperature decreases. Fan starts automatically at low speed. You can select either HIGH or LOW speeds. Fan cannot be manually turned off during this time.

PRECAUTIONS FOR PROPER USE:

1. **DO NOT** leave range unattended while using high temperatures. Automatic fan may start and provide excessive air to the surface units. This may cause spattering or boil-over.
2. Avoid burning food.
3. Keep grease filters clean.

SERVICE CALL CHECK

Please check the following before calling service:

1. Does the display light? Yes _____ No _____
2. When the door is opened, does the oven lamp light? Yes _____ No _____

If "No" is the answer for both, please check the wall socket and breaker. If both the wall socket and breaker are functioning properly, CONTACT YOUR NEAREST SHARP AUTHORIZED SERVICE STATION.

Please check the following if "Yes" is the answer to either of the above questions:

3. Place one cup of water in a glass measuring cup in the oven and close the door securely. Oven light should go off if the door is closed properly.

Program the oven for three minutes on HIGH, Touch these pads:

3	0	0
START		

- A. Does the oven lamp light? Yes _____ No _____
- B. Does the cooling fan work?
(Put your hand over the top ventilation openings.) Yes _____ No _____
- C. Does the turntable rotate? It is normal for the turntable to turn in either direction. Yes _____ No _____
- D. Do COOK and HIGH indicators light? Yes _____ No _____
- E. At the end of 3 minutes, is the water bubbling? Yes _____ No _____

4. Remove the water from the oven and program:

5	0	0
CONVEC		
450°F		
START		

- A. Do CONV, Fan Symbol, and COOK light? Yes _____ No _____
- B. After the oven shuts off, is the inside of the oven hot? Yes _____ No _____

If "NO" is the answer to any of the above questions, PLEASE CONTACT YOUR NEAREST SHARP AUTHORIZED SERVICE STATION.

NOTES

NOTES

NOTES

AUTO-TOUCH® GUIDE

<p>TO SET CLOCK</p> <ol style="list-style-type: none"> 1. Touch STOP/CLEAR. 2. Touch CLOCK. 3. Enter time of day by touching numbers. (Ex. 4:30) 4. Touch CLOCK. 	<p>STOP/CLEAR</p> <p>AUTO START CLOCK</p> <p>4 3 0</p> <p>AUTO START CLOCK</p>	<p>TO PREHEAT AND COOK WITH CONVECTION</p> <ol style="list-style-type: none"> 1. Touch CONVECTION. 2. Enter desired preheat temperature. (Ex. 325°F) 3. Enter cooking time by touching numbers. (Ex. 20 min.) 4. Touch START. 	<p>CONVEC</p> <p>325°F</p> <p>2 0 0 0</p> <p>START</p>																	
<p>TO USE MINUTE PLUS</p> <ol style="list-style-type: none"> 1. Touch MINUTE PLUS. 	<p>MINUTE PLUS</p>	<p>TO COOK WITH AUTOMATIC MIX</p> <ol style="list-style-type: none"> 1. Enter cooking time by touching numbers. (Ex. 25 min.) 2. Touch LOW MIX/BAKE or HIGH MIX/ROAST. 3. Touch START. <p>NOTE: If you want to change temperature, enter desired temperature after step 2.</p>	<p>2 5 0 0</p> <p>LOW MIX BAKE</p> <p>START</p>																	
<p>TO COOK WITH MICROWAVE</p> <ol style="list-style-type: none"> 1. Enter cooking time by touching numbers. (Ex. 1 min. 30 sec.) 2. Touch Power Level Pad. 3. Touch 5 (Ex. Medium). 4. Touch START. 	<p>1 3 0</p> <p>P-</p> <p>P-50</p> <p>START</p>	<p>BROILING</p> <ol style="list-style-type: none"> 1. Enter desired time by touching numbers. (Ex. 14 min.) 2. Touch BROIL. No food in oven. 3. Touch START. When oven signals, put food in oven. 	<p>1 4 0 0</p> <p>BROIL</p> <p>START</p>																	
<p>TO COOK WITH TEMPERATURE</p> <ol style="list-style-type: none"> 1. Place probe in food and in probe receptacle in the top center of the oven. Enter desired temperature. (Ex. 180°F) 2. Touch TEMP. 3. Touch Power Level pad. 4. Touch 5 (Ex. Medium). 5. Touch START. 	<p>1 8 0</p> <p>TEMP</p> <p>P-1</p> <p>P-50</p> <p>START</p>	<p>TO USE COMPU DEFROST</p> <ol style="list-style-type: none"> 1. Touch COMPU DEFROST. 2. Enter desired COMPU DEFROST setting. (Ex. Roast Beef-1) 3. Touch number pads to enter desired weight. (Ex. 2.95 lbs. round to 3.0 lbs.) 4. Touch START. During defrosting, oven will stop twice; check food. Touch START to continue defrosting. 	<p>COMPU DEFROST</p> <p>1</p> <p>3 0</p> <p>START</p>																	
<p>TO COOK WITH SENSOR TEMP</p> <ol style="list-style-type: none"> 1. Place probe in food and in probe receptacle in the top center of the oven. Touch SENSOR TEMP. 2. Enter desired Sensor Temp. setting. (Ex. Touch 2 to cook roast to medium doneness.) 3. Touch START. 	<p>SENSOR TEMP</p> <p>2</p> <p>START</p>	<p>COMPU DEFROST CHART</p> <table border="1"> <thead> <tr> <th>Food</th> <th>Amount</th> <th>Setting</th> </tr> </thead> <tbody> <tr> <td>Roast beef, Pork</td> <td>2.5-6.0 lbs.</td> <td>1</td> </tr> <tr> <td>Steaks, chops</td> <td>0.5-4.0 lbs.</td> <td>2</td> </tr> <tr> <td>Ground meat</td> <td>0.5-3.0 lbs.</td> <td>3</td> </tr> <tr> <td>Chicken, whole</td> <td>2.5-6.0 lbs.</td> <td>4</td> </tr> <tr> <td>Chicken pieces</td> <td>0.5-3.0 lbs.</td> <td>5</td> </tr> </tbody> </table>	Food	Amount	Setting	Roast beef, Pork	2.5-6.0 lbs.	1	Steaks, chops	0.5-4.0 lbs.	2	Ground meat	0.5-3.0 lbs.	3	Chicken, whole	2.5-6.0 lbs.	4	Chicken pieces	0.5-3.0 lbs.	5
Food	Amount		Setting																	
Roast beef, Pork	2.5-6.0 lbs.	1																		
Steaks, chops	0.5-4.0 lbs.	2																		
Ground meat	0.5-3.0 lbs.	3																		
Chicken, whole	2.5-6.0 lbs.	4																		
Chicken pieces	0.5-3.0 lbs.	5																		
<p>TO COOK WITH CONVECTION</p> <ol style="list-style-type: none"> 1. Enter cooking time by touching numbers. (Ex. 15 min.) 2. Touch CONVECTION. 3. Enter desired cooking temperature. (Ex. 425°F) 4. Touch START. 	<p>1 5 0 0</p> <p>CONVEC</p> <p>425°F</p> <p>START</p>																			

For more complete information, refer to your Operation Manual.

TO COOK WITH COMPUCOOK 1. Touch COMPUCOOK. 2. Select desired COMPUCOOK setting. (Ex. Touch 1 to broil hamburgers.) 3. Touch number pads to enter desired quantity or weight. (Ex. 4 patties) 4. Touch START. Oven will preheat to 450°F, then signal 4 times. Put food in the oven and touch START again.	COMPU COOK	REHEAT SENSOR 1. Touch REHEAT.	REHEAT
	1 4	POPCORN SENSOR 1. Touch POPCORN Be sure to elevate on inverted glass pie plate.	POPCORN ELEVATE PKG
	START	TO COOK WITH SENSOR 1. Touch SENSOR COOK. 2. Enter desired Sensor setting. (Ex. Touch 1 to cook baked potatoes.) 3. Touch START.	SENSOR COOK 1 START

COMPU COOK CHART

Food	Amount	Setting	Food	Amount	Setting
Broiled hamburger	2-8 pieces	1	Roast turkey	6.5-15.9 lbs.	4
Broiled chicken	0.5-3.5 lbs.	2	Layer cakes	1-2 layers	5
Roast chicken	2.5-7.5 lbs.	3	Bread, loaves	1-2 loaves	6

SENSOR COOK CHART

Food	Procedure	Comments	Setting
Reheat			
Dinner plate	Wrap with waxed paper		REHEAT
Leftovers		Stand, covered. 5 min.	
Canned foods	Casserole with lid or plastic wrap.		
Popcorn, package	Always elevate on center of inverted glass pie plate.	Use only popcorn packaged for microwave ovens.	POPCORN ELEVATE PKG.
Pizza, package	Follow package directions. Use special package	Microwave pizza only.	PIZZA
Baked potatoes	Prick with fork. Place directly on turntable.	Stand, covered with foil, 5-10 min.	1
Fresh vegetables, soft	Casserole with lid or plastic wrap. Add water, if required.	Stand, covered. 3-5 min.	2
Fresh vegetables, hard	Casserole with lid or plastic wrap. Add water.	Stand, covered. 5 min.	3
Sauté	Add butter and vegetables. Cover with plastic wrap.	Stand, covered, 5 min.	4
Frozen vegetables	Casserole with lid or plastic wrap.	Stand, covered, 3-5 min.	5
Soup, clear	Mug, bowl or casserole with lid or plastic wrap.	Stand, covered, 3-5 min.	6
Soup, cream	Mug, bowl or casserole with lid or plastic wrap.	Stand, covered, 3-5 min.	7
Hot dog with bun	Wrap in two paper towels.		8
Bacon	Place on paper plate, lined with paper towel. Cover with paper towel. Elevate paper plate on inverted paper plate.		9
Fish, Seafood			
Fillet, Steak, Shrimp	Arrange in ring around shallow glass dish.	Stand, covered, 3 min.	0
Scallops	Cover with plastic wrap.		
Clams	Place in plastic bag. Secure end. Slit bag with knife.	Stand, covered, 3 min.	

Free Manuals Download Website

<http://myh66.com>

<http://usermanuals.us>

<http://www.somanuals.com>

<http://www.4manuals.cc>

<http://www.manual-lib.com>

<http://www.404manual.com>

<http://www.luxmanual.com>

<http://aubethermostatmanual.com>

Golf course search by state

<http://golfingnear.com>

Email search by domain

<http://emailbydomain.com>

Auto manuals search

<http://auto.somanuals.com>

TV manuals search

<http://tv.somanuals.com>