



# 20 Series:

## 20/20A/20W

### Digital Key Telephone

### System

### USER GUIDE



- **aria** 20 SERIES DIGITAL KEY TELEPHONE SYSTEM USER GUIDE:  
*aria 20A, aria 20, aria 20W*

## **aria 20** KSU

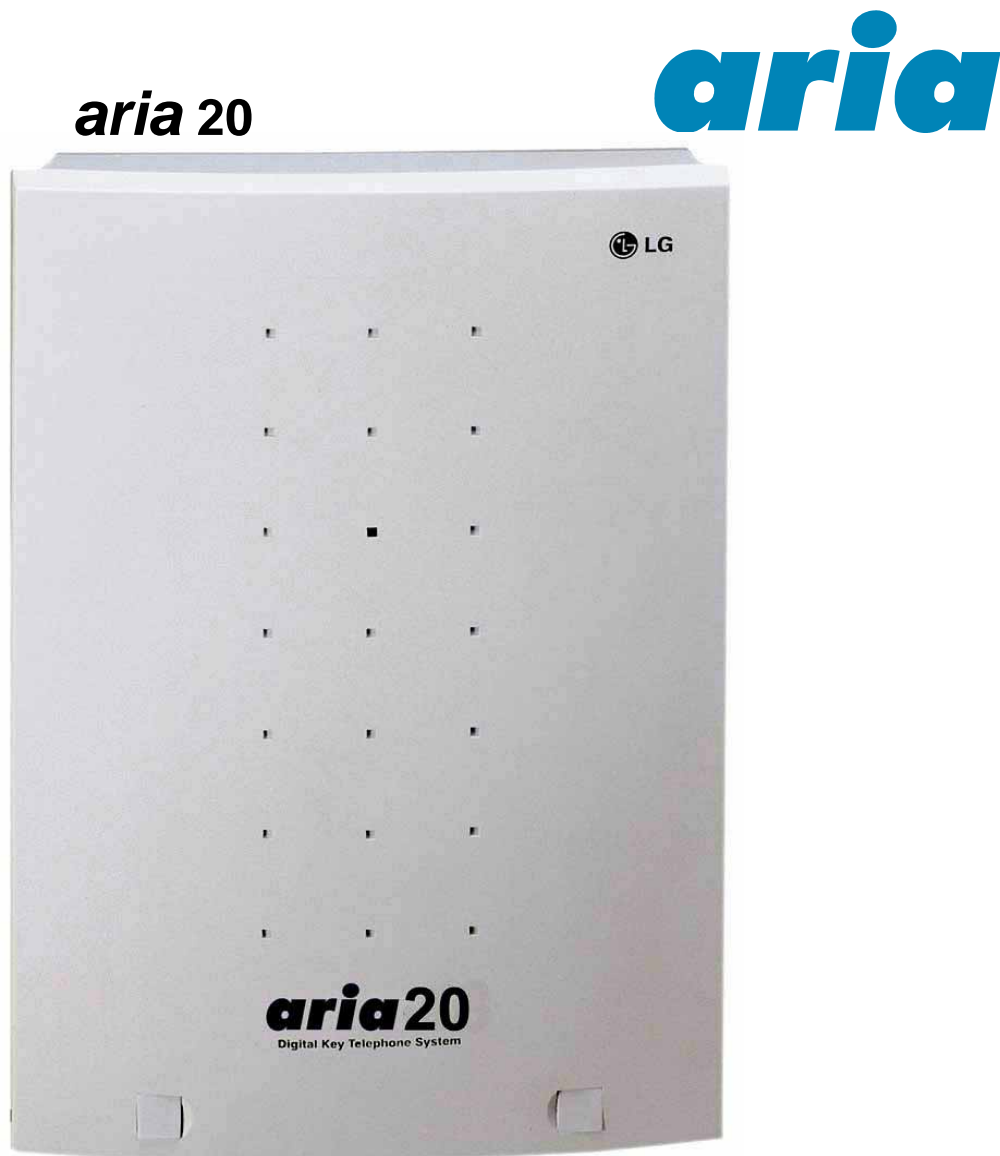

**aria** 20/ 20A/ 20W/ 16/ 16A *each have a similar Key-Telephone Service Unit Housing.*

**NB:** Although every effort is made to keep this Guide up to date, Features and Functions are subject to change without notice. An inclusion of a feature or function in this guide does not imply it is operational on your system. Some features require specific hardware or software installation. Please check with your **aria** dealer for further details.

## Index

<b>A</b>		<b>Attendant Operation</b>	
Alarm Reset .....	14	Attendant Clock Set.....	17
Answering an Intercom Call .....	10	Attendant DSS Operation.....	19
Auto Call Number Redial .....	8	Attendant Intrusion .....	18
<b>C</b>		Attendant Programming Menu Table .....	20
Call Back .....	11	Auto Ring Mode Service .....	18
Call Forward .....	12	Changing Time/Date Format .....	17
Call Park .....	9	Day/Night Mode Service .....	18
Call Transfer .....	8	Make a Page.....	19
Call Wait (Camp On).....	10	Overriding a Key Telephone in DND .....	19
Changing Differential Ring .....	11	System Greetings .....	17
Changing Intercom Answer Mode .....	10	System Speed Dial .....	18
CO Message Wait .....	15	To Erase SMDR Record .....	19
Conference .....	13	To Print out Accumulated SMDR Records .....	19
<b>D</b>		To Set Current Time 1 Hour Early/Late .....	18
DISA (Direct Inward System Access) .....	15	Transferring an Outside Line to Another Station.....	19
Do Not Disturb .....	11	Wake-up Call .....	17
<b>F</b>		<b>SLT Operation</b>	
Flash .....	13	Answering a Call Wait .....	21
<u>Flexible Key Programme Table</u> .....	16	Call Forwarding your Station .....	21
<b>G</b>		Call transfer (Screened and Unscreened) .....	21
Group Call Pick-up .....	13	Call Wait (Camp On) .....	21
<b>L</b>		CO Line Hold .....	21
Last Number Redial .....	8	Conference Calling .....	21
LCD Language Change .....	14	D N D (Do Not Disturb).....	22
<b>M</b>		Group Call Pick Up.....	21
Message Waiting .....	11	Last Number Redial .....	21
Mute .....	10	Meet Me Paging .....	22
<b>P</b>		Message Waiting (Callback).....	21
Paging .....	11	Outside Call.....	21
Placing a CO Call on Hold .....	13	Paging.....	21
Placing an Intercom Group Call .....	12	Placing an Intercom Call.....	21
Placing an Outside Call .....	8	Placing an Outside call on Hold .....	21
Programming Your Name into Display .....	13	Return Call to Host System.....	22
<b>*</b>		Shuttle Call .....	22
Queuing .....	9	Station Speed Dialing .....	21
<b>R</b>		Voice Announcements.....	22
Ring Volume Control .....	12	<b>20W DECT Supplement</b>	
<b>S</b>		GDC-340 LCD Display.....	23
Save Number Redial .....	13	GDC-340 Button Function.....	24
Speakerphone .....	12	<u>DECT Features</u> .....	25
Speaker Volume Control .....	12	Call Transfer.....	25
Speed Dial Numbers .....	9	Call Wait (Camp On).....	25
<u>Station Programming Menu Table</u> .....	16	Call Back.....	25
<b>T</b>		Attendant Call.....	25
Two-way Recording .....	14	Paging.....	25
<b>U</b>		DND.....	25
Universal Night Answer.....	8	Call Forward (& Cancel).....	25
<b>V</b>		Call Group Pilot.....	25
Voice Announcement .....	15	Group Call Pick Up.....	25
<b>W</b>		Universal Night Answer.....	25
Wake-up Call .....	14	CO Group Answer.....	25
		Individual CO Line Access.....	25
		Speed Dial.....	25
		Last Number Redial.....	25
		Wake Up Call.....	25
		GDC-340 Menu Tree.....	26

**Quick Reference Guide for *aria* Digital Key Telephone**

**Fixed Feature Buttons**

- ♦ **FLASH** button may be used to terminate an outside call and re-seize dial tone without having to hang up the handset.
- ♦ **SPEED** button provides you with access to speed dialing, save number redial and last number redial.
- ♦ **TRANS** (TRANSFER) button is used to transfer an outside call from a station to another.
- ♦ **CALLBK** (CALLBACK) button allows you to leave a callback indication at a station that is busy, unattended, or in Do Not Disturb.
- ♦ **CONF** button is used to establish conference calls.
- ♦ **DND/FWD** (Do Not Disturb/Forward) button allows you to forward your calls to another destination, or make DND mode.

**Call Forward**

- ♦ Press MON button.
- ♦ Press DND/FWD button and dial the desired Call Forward type.
  - 1 : Unconditional
  - 2 : Busy calls
  - 3 : No answer calls
  - 4 : Busy/no answer calls
  - 5 : Station off-net
  - 6 : Incoming outside line to off-net (**ATD only**)
  - 7 : DVU forward for no answer/busy
  - # : Cancel previous call forward
- ♦ Dial the station number or press DSS button or intercom group where calls are forwarded. (Confirmation tone is heard.)

**Call Wait (Camp-on)**

- If you dial a busy station, you may alert it to your call.
- ♦ After receiving intercom busy tone, dial \* or the last digit of called station number or press DSS button.
  - ♦ When the called party answers, consult with them or hang up to transfer the call.

**Conference**

- ♦ Call the desired party (internal or outside). When called party answers, press CONF button.
- ♦ Add next conference party by selecting another outside line or intercom station.
- ♦ When the party answers, press CONF button twice. All parties are connected.

To terminate a conference.

- The conference initiator should be actively in the conference.
- ♦ Hang up, or press CONF button to finish the conference (only for conference initiator).

**Leaving a Message Waiting Indication**

- If you dial a station that is unattended or in Do Not Disturb, you can leave a message waiting indication.
- ♦ Dial the desired intercom station. Busy tone or DND tone is heard.
  - ♦ Press CALLBK button. The called party's CALLBK button LED will flash.

To answer a Message Waiting Indication.

- ♦ Press flashing CALLBK button and the station that left message will be signaled with tone ringing.
- ♦ If called station does not answer, press the CALLBK button once to leave a message.

**Last Number Redial**

- The last dialed number on an outside line is saved.
- ♦ Press REDIAL button. Or,
  - ♦ Press SPEED button and dial \*.

**Universal Night Answer**

- When a CO call is ringing (If programmed by Installer)
- ♦ Dial **6 9**, the CO call is connected

- ♦ **MUTE** button allows you to switch the built in microphone on or off when using the speakerphone or the handset microphone when using the handset.
- ♦ **MON** button enables you to make a phone call without lifting handset. It turns the telephone on and off when using the speakerphone.
- ♦ **HOLD** button enables you to place an outside caller on hold.
- ♦ **REDIAL** allows you to make last number redial and auto call number redial.
- ♦ **VOLUME** ▲ bar allows you to adjust speakerphone and handset volume.

**Placing an Outside Call on Hold**

While connected to an outside line,

- ♦ Press HOLD/SAVE button.
  - Once for system hold
  - Twice for exclusive hold
- ♦ Reverse if hold preference is programmed to system hold.
- ♦ Press HOLD/SAVE button. CO line call will be put on hold according to the Hold Preference.

**Call Transfer**

While connected to an outside call,

- ♦ Press TRANS/PGM button.
- ♦ Dial station number or DSS button. (You can select a screened or unscreened transfer.)

Screened Transfer

When that extension answers, announce the transfer and hang up to complete call transfer.

Unscreened Transfer

When the called extension begins to signal, hang up to complete call transfer.

**Storing Speed Dial Numbers**

- ♦ Press TRANS/PGM button and then SPEED button.
- ♦ Dial the speed number bin.
  - Station Speed Number bins:

**aria 16**(ver. 1.0~3.0) & **aria 20W**(ver: 1.0~2.0) : **01~20**  
**aria 20** & **16**(ver. 4.0) & **20W**(ver: 3.0) : **01~19**

- System Speed Number bin: 21~99 (Attendant programmed)

Dial the phone numbers to be stored.

- ♦ Press HOLD/SAVE button to save the number.

To erase an exiting speed bin.

- ♦ Press TRANS/PGM button and then SPEED button.
- ♦ Dial speed number bin to be erased.
- ♦ Press HOLD/SAVE button.

**Dialing a Speed Number**

- ♦ Press SPEED button and dial the speed number bin.
- ♦ When the called party answers, pick up the handset or use speakerphone.

**Flexible Buttons Programming**

- ♦ Press TRANS/PGM button.
- ♦ Press a flexible button to be programmed.
- ♦ See the below chart and dial the desired code.
- ♦ Press HOLD/SAVE button.

Direct Station Select: 700~720 (**aria 20**), 700~730 (**aria 20W**)  
 700~715 (**aria 16**)

Call Wait (Camp-on).....TRANS/PGM + 8 5  
 Station Speed Dial.....SPEED + bin no(00~19)  
 for **aria 16**(ver. 1.0~3.0)/**20W**(ver: 1.0~2.0): 01~20  
 System Speed Dial.....SPEED + bin no. : 21~99  
 All Call Page.....# 0  
 Universal Night Answer 2  
 Last Number Redial.....SPEED + \*

To erase a flexible button,

- ♦ Press TRANS/PGM button.
- ♦ Press the flexible button to be erased.
- ♦ Press HOLD/SAVE button.

Quick Ref. Guide

## CONTENTS

<b>Index</b> (Alphabetical Order – Digital User Guide Section).....	2
<b>Quick Reference Guide</b> .....	3
<b>Digital Key Telephone Family</b> .....	7
<b>CO Line Features</b>	
Placing an Outside Call .....	8
Answering an Outside Call.....	8
Call Transfer .....	8
Last Number Redial.....	8
Auto Call Number Redial.....	8
Universal Night Answer.....	8
Queuing.....	9
Speed Dial Numbers .....	9
Call Park .....	9
Storing Dial By Name .....	10
<b>Intercom Features</b>	
Changing Intercom Answer Mode .....	10
Answering an Intercom Call .....	10
Directed Call Pick-up.....	10
Call Wait (Camp-on) .....	10
Mute .....	10
Changing Differential Ring .....	11
Message Waiting.....	11
Call Back.....	11
Paging .....	11
Do Not Disturb.....	11
Call Forward .....	12
Speakerphone .....	12
Speaker Volume Control.....	12
Ring Volume Control .....	12
<b>System Features</b>	
Placing an Intercom Group Call.....	12
Flash .....	13
Placing a CO Call on Hold .....	13
Group Call Pick-up.....	13
Conference .....	13
Programming Your Name into Display .....	13
Wake-up Call .....	14
Using Dial By Name .....	14
LCD Language Change .....	14
Alarm Reset .....	14
Two-way Recording .....	14
Voice Announcement .....	15
CO Message Wait .....	15
DISA (Direct Inward System Access) .....	15
Flexible Button Programming .....	16
Station Programming Menu Table .....	16
<b>Attendant Operation</b>	
Wake-up Call.....	17
System Greetings.....	17
Changing Time/Date Format .....	17
Attendant Clock Set .....	17
To Set Current Time 1 Hour Early/Late .....	18
System Speed Dial.....	18
Attendant Intrusion .....	18
Day/Night Mode Service.....	18
Auto Ring Mode Service.....	18
To Print out Accumulated SMDR Records.....	19
To Erase SMDR Record.....	19
Attendant LCD Language .....	19
Attendant DSS Operation .....	19
Make a Page .....	19
Transferring an Outside Line to Another Station.....	19
Overriding a Key Telephone in Do Not Disturb .....	19
Attendant Programming Menu Table.....	20

CO Line Features

Intercom Features

System Features

Attendant Features

## CONTENTS

### Analogue Single Line Telephone Operation

Placing a Outside Call.....	21
Placing an Intercom Call.....	21
Placing an Outside call on Hold .....	21
Group Call Pick Up .....	21
Message Waiting (Callback).....	21
Call Wait (Camp On) .....	21
Answering a Call Wait .....	21
Call transfer (Screened and Unscreened) .....	21
Last Number Redial .....	21
Station Speed Dialing .....	21
Conference Calling .....	21
Message Waiting (Callback).....	21
Call Forwarding your Station .....	21
Paging .....	21
CO Line Hold .....	21
Voice Announcements (Requires an Aria Voice Card).....	22
Meet Me Paging .....	22
Return Call to Host System.....	22
D N D (Do Not Disturb) .....	22
Shuttle Call .....	22
Programming Name for SLT.....	22
Call Park.....	22
Retrieve Call Park.....	22

### **20W DECT Supplement**

GDC-340 LCD Display.....	23
GDC-340 Button Function.....	24
<u>DECT Features :</u> .....	25
Call Transfer.....	25
Call Wait (Camp On).....	25
Call Back.....	25
Attendant Call.....	25
Paging.....	25
DND.....	25
Call Forward (& Cancel).....	25
Call Group Pilot.....	25
Group Call Pick Up.....	25
Universal Night Answer.....	25
CO Group Answer.....	25
Individual CO Line Access.....	25
Speed Dial.....	25
Last Number Redial.....	25
Wake Up Call.....	25
GDC-340 Menu Tree.....	26

### **DOCUMENT REVISION**

MW	22/09/03	Edit Pg 15, 7, 6; Removed Aria 16 Titles
	05-Sep-05	Reformat bullet and specialist fonts for PDF.



● **aria 20 SERIES DIGITAL KEY TELEPHONE SYSTEM USER GUIDE:**  
**aria 20A, aria 20, aria 20W**

**Digital Key Telephone Family**

**(You cannot use any Large LCD keyset (not shown) with aria 20/20A/20W system.)**

KD-36D : LCD Display, 24 Flexible Buttons  
 KD-36N : No LCD Display, 24 Flexible Buttons  
 KD-24D : LCD Display, 12 Flexible Buttons  
 KD-24N : No LCD Display, 24 Flexible Buttons

**KD Series**

- KD-36EXE



**KD/E Series**

- KD/E-36EXE



- KD/E-8BTN



KD/E-36EXE : LCD Display, 24 Flexible Buttons  
 KD/E-36ENH : No LCD Display, 24 Flexible Buttons  
 KD/E-24EXE : LCD Display, 12 Flexible Buttons  
 KD/E-24ENH : No LCD Display, 24 Flexible Buttons  
 KD/E-8 BTN : No LCD Display, 8 Flexible Buttons

- LKD-2N/S



- LKD-8D/S



- LKD-30DS



LKD-2N/S: No LCD Display, 2 Flexible Buttons  
 LKD-8D/S: LCD Display, 8 Flexible Buttons  
 LKD-30D: LCD Display, 30 Flexible Buttons (Dual LED with Flex. BTN 01~24 & Single LED with 25~30)  
 LKD-30LD: Large LCD Display, 30 Flexible Buttons (Dual LED with Flex. BTN 01~24 & Single LED with 25~30)  
 LKD-DSS: 48 Flexible Buttons

※ The LKD series keysets can be normally operated in the following S/W version or later.

**aria 34E: GS40P-1.2A // aria 100: GS00P-3.2A // aria 186: GS86P-5.1A**  
**aria 34E: GS40P-1.1Cd // aria 100: GS00P-3.1Df // aria 186: GS86P-4.0Ee**



● **aria 20 SERIES DIGITAL KEY TELEPHONE SYSTEM USER GUIDE:**  
**aria 20A, aria 20, aria 20W**

### Placing an Outside Call

Button	Procedures	Range
 MON	<ul style="list-style-type: none"> <li>• Lift handset or press <b>MON</b> button.</li> <li>• Press outside line button, pool button or dial <u>CO line access code</u>.</li> <li>• Dial desired party.</li> <li>• When called party answers, lift handset or use speakerphone.</li> </ul>	<b>1</b> OR: 4 + (1 ~ 4) OR: 48 + 20/16 :( 1 ~ 6) 20W :( 1 ~ 8)

### Answering an Outside Call

Button	Procedures	Range
 MON	<ul style="list-style-type: none"> <li>• Lift handset or press <b>MON</b> button to use speakerphone.</li> <li>• Press flashing CO line button or loop key. (NB: If the <i>Preferred Line Answer</i> feature is ON for your station, you may answer just by lifting handset, or press <b>MON</b>.)</li> </ul>	

### Call Transfer



Button	Procedures	Range
 <i>Screened Transfer</i> <i>Unscreened Transfer</i>	<p><b>To transfer an outside call to the other extension,</b></p> <ul style="list-style-type: none"> <li>• Press <b>TRANS/PGM</b> button. (The outside call is put on hold.)</li> <li>• Dial <u>station number</u> or appropriate DSS button.</li> <li>• You can make a screened or unscreened transfer.</li> </ul> <p>When the called extension answers, introduce the call hang up to complete call transfer.</p> <p>While the station you called rings, hang up to complete call transfer.</p> <p><b>To answer screened transfer,</b></p> <ul style="list-style-type: none"> <li>• When a station rings according to Intercom Answer Mode selection, answer the intercom call.</li> <li>• The transferring party hangs up, the call will be connected.</li> </ul>	16 : 700 ~ 715 20 : 700 ~ 720 20W: 700 ~ 730

### Last Number Redial

Button	Procedures	Range
 REDIAL	<p>The last dialed number on an outside line is saved.</p> <p>To redial the last dialed number,</p> <ul style="list-style-type: none"> <li>• Press <b>REDIAL</b> button. Or,</li> <li>• Press <b>SPEED + *</b>.</li> </ul>	

### Auto Call Number Redial

When the called party is busy or does not answer the call, the system can automatically redial the number by pre-programmed time interval.

Button	Procedures	Range
  MUTE	<ul style="list-style-type: none"> <li>• Press <b>REDIAL</b> button.</li> <li>• Hang up.</li> <li>• A busy or no answer number will be redialed automatically after pre-programmed time interval while <b>MUTE</b> button is lighting.</li> <li>• When called party answers, lift handset to talk.</li> </ul>	Available by Software: 16: Above V4.0 20W: Above V3.0 20: All

### Universal Night Answer



When CO lines are programmed for UNA and the system is placed into night mode, users can answer incoming CO line calls employing dial code regardless of pick-up group.

Button	Procedures	Range
 MON	<ul style="list-style-type: none"> <li>• Lift handset or press <b>MON</b> button.</li> <li>• Press flashing CO line button. If a CO line button is not assigned, dial <b>6 9</b>.</li> <li>• You will be connected to ringing outside line.</li> </ul>	

● **aria 20 SERIES DIGITAL KEY TELEPHONE SYSTEM USER GUIDE:**  
**aria 20A, aria 20, aria 20W**









### Queuing

When a CO line is busy, you can request a call back when the CO line is available. As soon as it becomes idle, you can be the first extension to get the CO line.

Button	Procedures	Range
 MON  CALL BK	<ul style="list-style-type: none"> <li>• Lift handset or press <b>MON</b> button.</li> <li>• Press busy outside line button or specific line group button.</li> <li>• Pressing <b>CALLBK</b> button, your <b>CALLBK</b> button is lighting, confirmation tone plays.</li> <li>• Hang up or press <b>MON</b> button.</li> </ul> <p><b>To answer a queue request,</b></p> <ul style="list-style-type: none"> <li>• When the busy CO line or specific line group returns to idle, you hear ring and the queued line button is flashing.</li> <li>• Lift handset and dial a desired phone number.</li> </ul>	Available by Software: <b>16:</b> Above V4.0 <b>20W:</b> Above V3.0

### Speed Dial Numbers (Station Basis)

Each extension can program up to 20 individual speed dial numbers in the station. The numbers are entered and stored by the user and it can be recalled at any time.

Button	Procedures	Range
 TRANS/PGM  SPEED  HOLD/SAVE	<p><b>To store station speed numbers,</b></p> <ul style="list-style-type: none"> <li>• Press <b>TRANS/PGM</b> button.</li> <li>• Press <b>SPEED</b> button.</li> <li>• Dial <u>speed number bin</u>.</li> <li>• Dial the phone numbers to be stored.</li> <li>• Press <b>HOLD/SAVE</b> button.</li> <li>• Enter name for Dial by Name. (optional)</li> </ul> <p style="text-align: center;"><b>Or,</b></p> <ul style="list-style-type: none"> <li>• Press <b>TRANS/PGM</b> button.</li> <li>• Press <b>SPEED</b> button.</li> <li>• Dial speed number bin.</li> <li>• Press desired outside line button.</li> <li>• Dial the phone number to be stored.</li> <li>• Press <b>HOLD/SAVE</b> button.</li> <li>• Enter name for Dial by Name. (optional)</li> <li>• Press <b>HOLD/SAVE</b> button.</li> </ul>	Station Speed bin: 00 ~19 Or 00 ~20
 MON  SPEED	<p><b>To use station speed numbers,</b></p> <ul style="list-style-type: none"> <li>• Lift handset or press <b>MON</b> button.</li> <li>• Press <b>SPEED</b> button.</li> <li>• Dial speed number bin.</li> </ul>	Dial by Name : Available by Software: <b>aria 16:</b> Above V4.0 <b>aria 20W:</b> Above V3.0 All <b>aria 20</b>
 TRANS/PGM	<p><b>To use system speed numbers,</b></p> <ul style="list-style-type: none"> <li>• Lift handset or press <b>MON</b> button.</li> <li>• Press <b>SPEED</b> button.</li> <li>• Dial <u>speed number bin</u>.</li> </ul>	System Speed bins 21~99
 SPEED	<p><b>To erase station speed numbers,</b></p> <ul style="list-style-type: none"> <li>• Press <b>TRANS/PGM</b> button.</li> <li>• Press <b>SPEED</b> button.</li> <li>• Dial speed number bin to be erased.</li> <li>• Press <b>HOLD/SAVE</b> button.</li> </ul>	
 HOLD/SAVE		

### Call Park



A call can be parked in a parking location and the call will be retrieved by dialing the location number. (The call can be picked up by another extension.)

Button	Procedures	Range
 TRANS/PGM	<p>While connected to an outside call,</p> <ul style="list-style-type: none"> <li>• Press <b>TRANS/PGM</b> button.</li> <li>• Dial <u>parking location</u>.</li> </ul> <p><b>To retrieve a parked call</b></p> <ul style="list-style-type: none"> <li>♂ Dial the parking location</li> <li>♂ You are connected to the caller</li> </ul>	601~606 Available by Software: <b>aria 16:</b> Above V4.0 <b>aria 20W:</b> Above V3.0 All <b>aria 20</b>

● **aria 20 SERIES DIGITAL KEY TELEPHONE SYSTEM USER GUIDE:**  
**aria 20A, aria 20, aria 20W**

**Storing Dial by Name**



Users for digital display phone can enter the called party's name so they can dial by name instead of dialing the phone number.

Button	Procedures	Range												
  	<ul style="list-style-type: none"> <li>Press <b>TRANS/PGM</b> button.</li> <li>Press <b>SPEED</b> button and speed number bin.</li> <li>Dial the desired phone number.</li> <li>Press <b>HOLD/SAVE</b> button.</li> <li>Enter the name up to 16 letters using the code:</li> </ul> <ul style="list-style-type: none"> <li>Press <b>HOLD/SAVE</b> button.</li> <li>Pressing [▼] key while entering name, the last character will be erased.</li> </ul>	<table border="1"> <tr> <td>Q - 11 Z - 12 . - 13 1 - 10</td> <td>A - 21 B - 22 C - 23 2 - 20</td> <td>D - 31 E - 32 F - 33 3 - 30</td> </tr> <tr> <td>G - 41 H - 42 I - 43 4 - 40</td> <td>J - 51 K - 52 L - 53 5 - 50</td> <td>M - 61 N - 62 O - 63 6 - 60</td> </tr> <tr> <td>P - 71 R - 72 S - 73 Q - 7* 7 - 70</td> <td>T - 81 U - 82 V - 83 8 - 80</td> <td>W - 91 X - 92 Y - 93 Z - 9# 9 - 90</td> </tr> <tr> <td>*1 - Blank *2 - : *3 - ,</td> <td>0-00</td> <td>#</td> </tr> </table>	Q - 11 Z - 12 . - 13 1 - 10	A - 21 B - 22 C - 23 2 - 20	D - 31 E - 32 F - 33 3 - 30	G - 41 H - 42 I - 43 4 - 40	J - 51 K - 52 L - 53 5 - 50	M - 61 N - 62 O - 63 6 - 60	P - 71 R - 72 S - 73 Q - 7* 7 - 70	T - 81 U - 82 V - 83 8 - 80	W - 91 X - 92 Y - 93 Z - 9# 9 - 90	*1 - Blank *2 - : *3 - ,	0-00	#
Q - 11 Z - 12 . - 13 1 - 10	A - 21 B - 22 C - 23 2 - 20	D - 31 E - 32 F - 33 3 - 30												
G - 41 H - 42 I - 43 4 - 40	J - 51 K - 52 L - 53 5 - 50	M - 61 N - 62 O - 63 6 - 60												
P - 71 R - 72 S - 73 Q - 7* 7 - 70	T - 81 U - 82 V - 83 8 - 80	W - 91 X - 92 Y - 93 Z - 9# 9 - 90												
*1 - Blank *2 - : *3 - ,	0-00	#												

Available by Software:  
**aria 16:** Above V4.0  
**aria 20W:** Above V3.0  
**All aria 20**

CO Line Features

**Changing Intercom Answer Mode**

Button	Procedures	Range
 	<ul style="list-style-type: none"> <li>Press <b>TRANS/PGM</b> button.</li> <li>Dial <b>4 9</b></li> <li>Dial 1 for Hands-free, 2 for Tone ring, or 3 for Privacy announce.</li> <li>Press <b>HOLD/SAVE</b> button.</li> <li>Dial intercom number or press programmed DSS button.</li> <li>You will hear, <ul style="list-style-type: none"> <li>Ring back tone in TN (Tone) mode. Wait for called station to answer the ringing.</li> <li>3 bursts of tone in HF(Hands-free) or PV(Privacy) mode. Begin your announcement after the tone.</li> </ul> </li> </ul>	

Intercom Features

**Answering an Intercom Call**

Button	Procedures	Range
	<ul style="list-style-type: none"> <li>With your intercom answer mode setting, <ul style="list-style-type: none"> <li>in TN mode, intercom ring is heard. Lift handset to talk.</li> <li>in PV mode, 3 bursts of tone and one-way announcement is heard. Lift handset to talk.</li> <li>in HF mode, 3 bursts of tone and announcement is heard. Reply with Hands-free mode or lift handset for privacy.</li> </ul> </li> </ul>	

**Directed Call Pick-up**

Button	Procedures	Range
	<ul style="list-style-type: none"> <li>You hear intercom or transferred outside line ring at a station. Available by Software:</li> <li>Lift handset or press <b>MON</b> button.</li> <li>Dial * <b>42</b> and the ringing <u>station number</u>.</li> <li>You will be connected to the calling party.</li> </ul>	<b>16 :</b> 700~ 715 <b>20 :</b> 700~ 720 <b>20W:</b> 700~730 <b>All aria 20</b>

**Call Wait (Camp-on)**

If you dial a busy station, you may alert it of your call.

Button	Procedures	Range
	<ul style="list-style-type: none"> <li>After receiving busy tone, dial "*" or last digit of called station number, or press DSS.</li> <li>Camp-on tone is heard in called station.</li> <li>When called party answers, talk or hang up to transfer the call.</li> </ul>	



**Mute**

It provides privacy during speakerphone or handset operation by disabling the microphone.

Button	Procedures	Range
	<ul style="list-style-type: none"> <li>Press <b>MUTE</b> button to activate.</li> <li>Press <b>MUTE</b> button again to deactivate.</li> </ul>	



● **aria 20 SERIES DIGITAL KEY TELEPHONE SYSTEM USER GUIDE:**  
**aria 20A, aria 20, aria 20W**

### Changing Differential Ring

Button	Procedures	Range
 	<ul style="list-style-type: none"> <li>Press <b>TRANS/PGM</b> button.</li> <li>Dial <b>5 0</b></li> <li>Select the ring type by dialing 1~4.</li> <li>Press <b>HOLD/SAVE</b> button.</li> </ul>	



### Message Waiting

When the called extension does not answer the call, you can leave a message wait to the station.

Button	Procedures	Range
	<ul style="list-style-type: none"> <li>If a called party does not answer, press <b>CALLBK</b> button.</li> <li>Hang up.</li> <li>At that time, the LED of CALLBK button in the called station is flashing.</li> </ul>	
<p>On LKD-2N/S, 8D/S,</p>		
 	<ul style="list-style-type: none"> <li>If a called party does not answer, press <b>TRANS/PGM</b> button and dial <b>5 6</b></li> </ul> <p><b>To answer a message waiting,</b></p> <ul style="list-style-type: none"> <li>Press flashing <b>CALLBK</b> button.</li> <li>Station that left message will be signaled with tone ring.</li> </ul>	
<p>On LKD-2N/S, 8D/S,</p>		
	<ul style="list-style-type: none"> <li>Dial <b>5 7</b> to answer a message waiting.</li> </ul>	

### Call Back

If you dial a station that is busy, you can leave a callback indication.

Button	Procedures	Range
 	<ul style="list-style-type: none"> <li>After receiving intercom busy tone, press <b>CALLBK</b> button.</li> <li>Hang up.</li> <li>When the busy station hangs up, you will be signaled.</li> <li>Answer the signal by lifting handset or by pressing <b>MON</b> button, the station you called will be signaled.</li> </ul>	

### Paging

A station, which is allowed to access page facilities, can connect and transmit voice announcement to any or all of the system external/internal page zones.

Button	Procedures	Range										
	<p>To make a page,</p> <ul style="list-style-type: none"> <li>Lift handset.</li> <li>Dial page zone. (See chart.)</li> </ul> <p>And you will hear warning tone.</p> <ul style="list-style-type: none"> <li>After the tone, speak your message.</li> <li>Hang up.</li> </ul>	<table border="1"> <tbody> <tr> <td>All Call</td> <td># 0</td> </tr> <tr> <td>Internal Zone 1</td> <td># 1</td> </tr> <tr> <td>Internal Zone 2</td> <td># 2</td> </tr> <tr> <td>Internal All Call</td> <td># 4</td> </tr> <tr> <td>External All Call</td> <td># 3</td> </tr> </tbody> </table> <p>Internal Zones: 1~2</p>	All Call	# 0	Internal Zone 1	# 1	Internal Zone 2	# 2	Internal All Call	# 4	External All Call	# 3
All Call	# 0											
Internal Zone 1	# 1											
Internal Zone 2	# 2											
Internal All Call	# 4											
External All Call	# 3											





### Do Not Disturb

Button	Procedures	Range
	<p>If your phone has been programmed to have Do Not Disturb,</p> <ul style="list-style-type: none"> <li>Press <b>DND/FWD</b> button while on-hook or your phone is ringing.</li> <li>The LED is lighting and your phone is in DND.</li> </ul> <p><b>To remove Do Not Disturb,</b></p> <ul style="list-style-type: none"> <li>Press <b>DND/FWD</b> button while on-hook.</li> <li>The LED is extinguished and DND at your phone is removed.</li> </ul>	
<p>On LKD-2N/S, 8D/S,</p>		
	<ul style="list-style-type: none"> <li>Dial <b>5 3</b> instead of pressing <b>DND/FWD</b> button (Toggle setting).</li> </ul>	

● **aria 20 SERIES DIGITAL KEY TELEPHONE SYSTEM USER GUIDE:**  
**aria 20A, aria 20, aria 20W**

### Call Forward

A call can be forwarded to the other station or group depending on the call forward type. It should be programmed in Admin.

Button	Procedures	Range
 MON  DND/FWD	<ul style="list-style-type: none"> <li>♦ Lift handset or press <b>MON</b> button. (The <b>MON</b> button is lighting.)</li> <li>♦ Press <b>DND/FWD</b> button.</li> <li>♦ Press the call forward type;               <ol style="list-style-type: none"> <li>1 - Unconditional</li> <li>2 - Busy calls</li> <li>3 - No answer calls</li> <li>4 - Busy / no answer calls</li> <li>5 - Station off-net</li> <li>6 - Incoming outside line to off-net (system attendant only)</li> <li>7 - DVU forward for no answer/busy</li> </ol> </li> <li>♦ (# - Cancel all Call Forwards)</li> <li>♦ Dial <u>station number</u> or press DSS button or <u>intercom group</u>.</li> <li>♦ Confirmation tone is heard and <b>DND/FWD</b> button is flashing on forwarded station.</li> <li>♦ Hang up.</li> </ul> <p>- In case <b>Station Off-net</b>, the number you are forwarding to should be saved as a speed dial number first.</p> <p>- In case <b>Incoming outside line to Off-net</b>, it requires system programming. (<b>DND/FWD</b> + dial 7; in no answer case, the forwarding time can be programmed with Installer Programming.)</p> <p><b>To cancel call forward,</b></p> <ul style="list-style-type: none"> <li>♦ Lift handset or press <b>MON</b> button.</li> <li>♦ Press <b>DND/FWD</b> button and dial #.</li> <li>♦ Hang up.</li> </ul> <p>- <b>To cancel Incoming Outside line to Off-net</b> (at system attendant), Press <b>MON</b> + <b>DND/FWD</b> + <b>CO line code (CO group/CO line no. /CO BTN) + #</b></p>	Station. No. 16 : 700~ 715 20 : 700~ 720 20W: 700~730
 MON  DND/FWD	<p>On LKD-2N/S, 8D/S,</p> <ul style="list-style-type: none"> <li>♦ Dial <b>5 4</b> instead of pressing <b>DND/FWD</b> button.</li> </ul>	Range ICM. Group 61~64

### Speakerphone

Pressing an outside line button, a speed button, a station button or dialing a station number will automatically activate the speakerphone. (LKD-2N/S has no microphone and doesn't function as Hands-free unit.)

Button	Procedures	Range
 MON	<ul style="list-style-type: none"> <li>To activate speakerphone,</li> <li>♦ Press <b>MON</b> button.</li> <li>♦ Dial outside line number or intercom number to talk.</li> </ul>	

### Speaker Volume Control

Button	Procedures	Range
	<ul style="list-style-type: none"> <li>♦ In speakerphone mode, press <b>VOLUME</b> (▲/▼) button to control the speakerphone volume.</li> </ul>	

### Ring Volume Control

Button	Procedures	Range
	<ul style="list-style-type: none"> <li>♦ When bell rings, press <b>VOLUME</b> (▲/▼) button to control ring volume.</li> </ul>	

### Placing an Intercom Group Call

Button	Procedures	Range
 MON	<p><b>To make an intercom group call,</b></p> <ul style="list-style-type: none"> <li>♦ Lift handset or press <b>MON</b> button.</li> <li>♦ Dial the <u>intercom group number</u>.</li> </ul>	ICM. Group No. 61~64

● **aria 20 SERIES DIGITAL KEY TELEPHONE SYSTEM USER GUIDE:**  
**aria 20A, aria 20, aria 20W**

**Flash**

May disconnect outside line and re-seize dial tone if programmed . It can be used to send a recall to line, when the system is connected with a PBX or Enhanced Feature Analogue Line.

Button	Procedures	Range
	<ul style="list-style-type: none"> <li>While connected to an outside line, press <b>FLASH</b> button.</li> </ul>	



**Placing a CO Call on Hold**

Button	Procedures	Range
	<p><b>While on a CO call</b></p> <ul style="list-style-type: none"> <li>Press <b>HOLD/SAVE</b> button.</li> <li>- Hold Preference for system hold or exclusive hold is set at Installer programming</li> </ul> <p><b>To retrieve the call,</b></p> <ul style="list-style-type: none"> <li>Lift handset and press flashing outside line button. OR dial <b>8 #</b> and the CO line number</li> </ul>	

**Group Call Pick-up**



Button	Procedures	Range
	<p>You should be in the same pick-up group as ringing phone.</p> <ul style="list-style-type: none"> <li>You hear an unattended phone ringing.</li> <li>Lift handset or press <b>MON</b> button.</li> <li>Dial <b>6 6</b></li> </ul>	

**Conference**

Button	Procedures	Range
	<p><b>To establish a conference,</b></p> <ul style="list-style-type: none"> <li>Call desired party. (internal or outside)</li> <li>Press <b>CONF</b> button. (<b>CONF</b> button is lighting and the called party is put on exclusive hold.)</li> <li>Call the next party.</li> <li>Press <b>CONF</b> button twice. (once if adding additional parties)</li> <li>Conference is established.</li> </ul> <p><b>To exit a conference (unsupervised),</b></p> <ul style="list-style-type: none"> <li>Press <b>CONF</b> button in the supervisor station and hang up. Other parties are still connected.</li> </ul> <p><b>Re-entering a conference,</b></p> <ul style="list-style-type: none"> <li>Lift handset or press <b>MON</b> button.</li> <li>Press <b>CONF</b> button.</li> </ul> <p><b>To drop an outside party, (not available in aria 16/20W)</b>            (You should be active in the conference.)</p> <ul style="list-style-type: none"> <li>Press outside line of party you wish to drop.</li> <li>Hang up or press <b>MON</b> button.</li> </ul> <p><b>To terminate the conference,</b></p> <ul style="list-style-type: none"> <li>Hang up or, press <b>CONF</b> button if unsupervised.</li> </ul>	<div style="border: 1px solid black; padding: 5px;"> <p><b>NB:</b> At most 3 parties can be active in a conference.</p> </div>
	<p>On LKD-2N/S, 8D/S,</p> <ul style="list-style-type: none"> <li>Conference feature can be accomplished by programming a flexible key as <b>CONF</b> button (TRANS + 91).</li> </ul>	

**Programming Your Name into Display**



You can program your name and people using display phones will see your name instead of your station number.

Button	Procedures	Range
	<ul style="list-style-type: none"> <li>Press <b>TRANS/PGM</b> button.</li> <li>Press <b>SPEED</b> button and dial <b>0 0</b>.</li> <li>Press <b>SPEED</b> button.</li> <li>Enter your name. (up to 7 letters using the code in "Storing Dial by name.)</li> <li>Press <b>HOLD/SAVE</b> button.</li> </ul>	<p>Available by Software:            16: Above V4.0            20W: Above V3.0</p>
		

● **aria 20 SERIES DIGITAL KEY TELEPHONE SYSTEM USER GUIDE:**  
**aria 20A, aria 20, aria 20W**



**Wake-up Call**

The system automatically sends ring signal to a station which registers a wake-up time. There are two kinds of wake-up call, one is effective for one-day, the other is effective until canceled.

Button	Procedures	Range
  TRANS/PGM HOLD/SAVE	<p><b>To register wake-up time,</b></p> <ul style="list-style-type: none"> <li>Press <b>TRANS/PGM</b> button.</li> <li>Dial <b>4 1</b> and 4-digit wake-up time (HHMM) in 24-hour mode.</li> <li>Press <b>HOLD/SAVE</b> button for "one-day" or dial # and <b>HOLD/SAVE</b> button for "until canceled". (Confirmation tone is heard.)</li> </ul> <p><b>To cancel wake-up call,</b></p> <ul style="list-style-type: none"> <li>Press <b>TRANS/PGM</b> button and dial <b>4 2</b>.</li> <li>Press <b>HOLD/SAVE</b> button. (Confirmation tone is heard.)</li> </ul>	

**Using Dial By Name**

Each station and speed dial number can be assigned to a name. When names are programmed, you may select a speed dial number by the stored name.

Button	Procedures	Range
   SPEED VOLUME HOLD/SAVE	<ul style="list-style-type: none"> <li>Press <b>SPEED</b> button twice.</li> <li>On the display, you will see the following.</li> <li>Select desired type.</li> <li>Confirmation tone is heard and you will see the following:</li> <li>Press the <b>VOLUME</b> button to see the next two names.</li> <li>You may enter characters using the code in "Storing Dial by Name". The LCD will display the first two names which match your input.</li> <li>To select the name in line 1, press <b>HOLD/SAVE</b> button.</li> <li>To select the name in line 2, dial 2 and press <b>HOLD/SAVE</b> button.</li> <li>The call is placed automatically.</li> </ul> <div style="border: 1px solid black; padding: 5px; margin: 10px 0;"> <p style="text-align: center;">DIAL BY NAME</p> <p style="text-align: center;">ICM : 1 U_SPD : 2 S_SPD : 3</p> </div> <div style="border: 1px solid black; padding: 5px; margin: 10px 0;"> <p>1 : XXXX XXXX XXXXXX</p> <p>2 : YYYY YYYY YYYYYY</p> </div>	

**LCD Language Change**

Button	Procedures	Range
 TRANS/PGM	<ul style="list-style-type: none"> <li>Press <b>TRANS/PGM</b> button and dial <b>5 1</b>.</li> <li>The language in LCD is changed into default value.</li> <li>If pressing TRANS/PGM + 5 1, the language in the LCD is changed to the nation's language.</li> </ul>	Available by Software: 16: Above V4.0 20W: Above V3.0

**Alarm Reset**

Button	Procedures	Range
	To terminate alarm signal while idle state, <ul style="list-style-type: none"> <li>Dial <b>6 5</b></li> <li>Confirmation tone is heard and the alarm signal is terminated at all assigned stations.</li> </ul>	

**Two-way Recording**





While a CO line call, you can record the conversation and it will be saved in its own mailbox.

Button	Procedures	Range
	<p><b>To record the conversation,</b></p> <ul style="list-style-type: none"> <li>Press the programmed {RECORD} button.</li> </ul> <p>To program the {RECORD} button,            [TRANS/PGM] + Flex. BTN + [TRANS/PGM] + # 4 + [HOLD/SAVE]</p> <p><b>To finish the recording,</b></p> <ul style="list-style-type: none"> <li>Press the programmed {RECORD} button again. Or, replace the handset.</li> </ul>	







● **aria 20 SERIES DIGITAL KEY TELEPHONE SYSTEM USER GUIDE:**  
**aria 20A, aria 20, aria 20W**

**Voice Announcement**

Button	Procedures	Range
	<p><b>Record your greeting,</b></p> <ul style="list-style-type: none"> <li>♦ Lift handset or press <b>MON</b> button.</li> <li>♦ Press <b>DND/FWD</b> button.</li> <li>♦ Dial <b>7 #</b> Record your greeting</li> <li>♦ Press <b>Hold/Save</b></li> </ul> <p><i>NB:</i> Call Forward to DVU is automatically enabled after recording your greeting.</p> <p><b>Delete your greeting,</b></p> <ul style="list-style-type: none"> <li>♦ Lift handset or press <b>MON</b> button.</li> <li>♦ Press <b>DND/FWD</b> button.</li> <li>♦ Dial <b>7 *</b> .</li> </ul> <p><b>Activate Call Forward to DVU,</b></p> <ul style="list-style-type: none"> <li>♦ Lift handset or press <b>MON</b> button.</li> <li>♦ Press <b>DND/FWD</b> button.</li> <li>♦ Dial <b>7</b> .</li> <li>♦ Go on-hook.</li> </ul> <p><b>Deactivate Call Forward to DVU,</b></p> <ul style="list-style-type: none"> <li>♦ Lift handset or press <b>MON</b> button.</li> <li>♦ Press <b>DND/FWD</b> button.</li> <li>♦ Dial <b>#</b>.</li> <li>♦ Go on-hook.</li> </ul> <p><b>To listen to the recorded message,</b></p> <ul style="list-style-type: none"> <li>♦ Press the flashing <b>CALLBK</b> button.</li> <li>♦ The recorded message is heard with the time and date.</li> <li>♦ Pressing <b>HOLD/SAVE</b> button, the current message is saved and the next message is heard.</li> <li>♦ Pressing <b>CALLBK</b> button, the recorded message is heard from the first.</li> <li>♦ Pressing <b>CONF</b> button, the current message is deleted.</li> </ul> <p>• The operation of 2/8 BTN keyset is the same as <b>aria</b> 186/100 /34e systems. (Refer to p.36)</p> <p>※ The max. user recording time is about 250sec. (Default: 20sec: it can be set with installer programming)</p>	
		
		
		

**CO Message Wait (CLI Message Wait)**

When a call is received with DISA/DID, the Calling Line Identification (CLI) of the incoming call is displayed on the LCD of the station. If the DISA/DID external party hangs up the call before answered, the CLI will be stored in the CO message wait queue in the called party.

Button	Procedures	Range
	<p><b>To retrieve CLI Message,</b></p> <ul style="list-style-type: none"> <li>♦ Press <b>CALLBK</b> button.</li> <li>♦ The stored message will be shown on the LCD.</li> </ul>	
	<p><b>To delete the current CLI message and see the next one,</b></p> <ul style="list-style-type: none"> <li>♦ Press <b>CONF</b> button.</li> </ul>	
	<p><b>To make a callback,</b></p> <ul style="list-style-type: none"> <li>♦ Press <b>HOLD/SAVE</b> button.</li> <li>♦ The stored number is dialed as speed dialing.</li> </ul>	
	<p><b>To see the next/previous CLI message,</b></p> <ul style="list-style-type: none"> <li>♦ Press <b>VOLUME</b> button.</li> </ul> <p><b>To delete all CLI messages, (Not available in aria 20/16/20W)</b></p> <ul style="list-style-type: none"> <li>♦ Press <b>SPEED</b> button twice.</li> <li>♦ If DVU message is stored with CLI message, the CLI message will not be deleted by pressing <b>SPEED</b> button.</li> </ul>	

**DISA (Direct Inward System Access)**



Outside caller can access a CO line which is programmed as DISA line.

Button	Procedures	Range
	<ul style="list-style-type: none"> <li>♦ Dial the CO access code after hearing dial tone or voice guide from DVU.</li> <li>♦ Or, dial the CO access code after dialing the programmed authorization code (when needed) for outgoing call.</li> </ul>	



● **aria 20 SERIES DIGITAL KEY TELEPHONE SYSTEM USER GUIDE:**  
**aria 20A, aria 20, aria 20W**

**Flexible Button Programming**

Button	Procedures	Range
 TRANS/PGM	<b>To program flexible buttons,</b> <ul style="list-style-type: none"> <li>• Press <b>TRANS/PGM</b> button.</li> <li>• Press a flexible button to program.</li> <li>• See the <u>below table</u> and enter the desired code.</li> <li>• Press <b>HOLD/SAVE</b> button.</li> </ul>	
 HOLD/SAVE	<b>To erase a flexible button,</b> <ul style="list-style-type: none"> <li>• Press <b>TRANS/PGM</b> button.</li> <li>• Press the flexible button to be erased.</li> <li>• Press <b>HOLD/SAVE</b> button.</li> </ul>	

**Code for Flexible Button Programming**

Direct Station Select	station number 16 : 700~715 20 : 700~720 20W: 700~730	Paging See page...
Hunt Group	internal hunt group 20/16/20W: 61~64	Speed Dial SPEED + <u>bin no</u> Station 20/16/20W: 00~19 <i>*aria 16(V1.0~V3.0),aria 20W(V1.0~V2.0): 01~20</i>
Group Call Pick-up	66	System speed dial SPEED + <u>bin no.</u> 20/16/20W 21~99
Directed Call Pick-up *	*42	Outside Line Access 1
Alarm Reset	6 5	Group access 4
Station DVU Access	6 7	Group #1 4 0 1 20/16/20W: Grp#01~04
Call Wait (Camp-on)	TRANS/PGM + 8 5	Individual Line Access 4 8 + <u>line no.</u> 20/16 :01~06 20W:01~08
Wake-up (To register)	TRANS/PGM + 4 1	
To cancel	TRANS/PGM + 4 2	
Headset/Speaker	TRANS/PGM + 5 7	
Background Music	TRANS/PGM + 7 3	
LCD Display Change	TRANS/PGM + 5 1	
Intercom Hold	TRANS/PGM + 8 3	
Loop button	TRANS/PGM + 8 4	
Intercom Answer Mode	TRANS/PGM + 4 9	
Stop Watch Event Timer	TRANS/PGM + 8 9	
Account Code	TRANS/PGM + 8 1	
Camp-on	TRANS/PGM + 8 5	
<b>Button Programming for LKD-2/8 button</b>		
	REDIAL button	TRANS + 8 8
	SPEED button	TRANS + 9 0
	CONF button	TRANS + 9 1
	CALLBK button	TRANS + 9 2
	DND button	TRANS + 9 3
	MUTE button	TRANS + 9 5





**Station Programming Codes**

The **aria** system supports multiple hierarchical menus based on station programming. User can make station programming by selecting desired menu. By pressing [TRANS/PGM ] button in a keyset with LCD, user can see the menu.

Main Menu	Sub Menu	Selection	Remark
TRANS/PGM [4]	[0] Aria SW Ver.		
	[1] Wake Up Call Programme	HH/MM	(ATD Sta Range..)
	[2] Wake Up Call Cancel		Erased Wake Up Time (HH:MM)
	[9] ICM Signal Mode	1(H) 2(T) 3(P)	Hands free; Tone; Privacy
TRANS/PGM [5]	[0] Differential Ring	1 - 4	4 Tones for Ringing
	[1] Station Language Code	Press Hold	Change LCD to 2 <sup>nd</sup> Language
	[8] COLR/CLIP		Restricts in coming and out going - Caller ID.



● **aria 20 SERIES DIGITAL KEY TELEPHONE SYSTEM USER GUIDE:**  
**aria 20A, aria 20, aria 20W**

**Wake-up Call**

Button	Procedures
 TRANS/PGM  HOLD/SAVE  TRANS/PGM  HOLD/SAVE	<p><b>To register wake-up call,</b></p> <ul style="list-style-type: none"> <li>• Press <b>TRANS/PGM</b> button.</li> <li>• Dial <b>4 1</b></li> <li>• Enter the station range (XXX-YYY) to receive wake-up call.</li> <li>• After hearing confirmation tone, enter 4-digit wake-up time (HHmm) in 24-hour mode. (HH= 00-23, mm= 00-59)</li> <li>• Press <b>HOLD/SAVE</b> button for one-day, or dial # and <b>HOLD/SAVE</b> button for until canceled.</li> </ul> <p><b>To cancel wake-up call,</b></p> <ul style="list-style-type: none"> <li>• Press <b>TRANS/PGM</b> button.</li> <li>• Dial <b>4 2</b> . (Confirmation tone is heard and <b>MON</b> button is lighting.)</li> <li>• Dial the station range to be canceled.</li> <li>• Press <b>HOLD/SAVE</b> button. (<b>MON</b> button will be extinguished.)</li> </ul>

**System Greetings**

It provides announcements for Hunt service (UCD/Circular/Terminal) or DISA and only the system attendant can record this message.

Button	Procedures										
 TRANS/PGM  HOLD/SAVE	<ul style="list-style-type: none"> <li>• Press <b>TRANS/PGM</b> button.</li> <li>• Dial <b># 4</b>.</li> <li>• Select the announcement type. (1: System Greeting, 2: System Prompt)</li> <li>• Dial the announcement number.</li> <li>• Dial the source number (1: external MOH, 2: DKTU)</li> <li>• Dial # to start recording.</li> <li>• Press <b>HOLD/SAVE</b> button.</li> <li>• You have <b>19</b> System Greetings and 9 Prompts;</li> </ul> <p><u>System Greetings (Announcement Type 1)</u></p> <ol style="list-style-type: none"> <li>1: Day Time System Greeting</li> <li>2: Night Time System Greeting</li> <li>3: Circular &amp; Terminal Hunt Group Greeting</li> <li>4: 1st UCD Group Announcement</li> <li>5: 2nd UCD Group Announcement</li> <li>6: Ring Group Announcement (GDK-16: version 4.0XX, 20W: version 3.0XX)</li> <li>7: DVIB MOH</li> <li>8: SLT Message Waiting Indication Announcement (GDK-16: version 4.0XX, 20W: version 3.0XX)</li> <li>9: Off-Net Forward Announcement (GDK-16: version 4.0XX, 20W: version 3.0XX)</li> <li>10: Group Overflow Announcement (GDK-16: version 4.0XX, 20W: version 3.0XX)</li> <li>11-19: CCR Announcement (GDK-16: version 4.0XX, 20W: version 3.0XX)</li> </ol> <p><u>System Prompts (Announcement Type 2)</u></p> <table border="0"> <tr> <td>1: Timeout Prompt</td> <td>6: No Answer Prompt</td> </tr> <tr> <td>2: Retry Prompt</td> <td>7: Transfer to Attendant Prompt</td> </tr> <tr> <td>3: Busy Prompt</td> <td>8: Authorization Code Prompt</td> </tr> <tr> <td>4: DND Prompt</td> <td>9: Record Start Prompt</td> </tr> <tr> <td>5: Invalid Prompt</td> <td></td> </tr> </table> <ul style="list-style-type: none"> <li>• To delete announcement, dial the announcement number and #.</li> </ul>	1: Timeout Prompt	6: No Answer Prompt	2: Retry Prompt	7: Transfer to Attendant Prompt	3: Busy Prompt	8: Authorization Code Prompt	4: DND Prompt	9: Record Start Prompt	5: Invalid Prompt	
1: Timeout Prompt	6: No Answer Prompt										
2: Retry Prompt	7: Transfer to Attendant Prompt										
3: Busy Prompt	8: Authorization Code Prompt										
4: DND Prompt	9: Record Start Prompt										
5: Invalid Prompt											

Attendant Operation

**Changing Time/Date Format**

Button	Procedure
 TRANS/PGM	<p><b>To change the date format on the LCD,</b></p> <ul style="list-style-type: none"> <li>• Press <b>TRANS/PGM</b> button.</li> <li>• Dial * <b>5</b></li> <li>• The format toggles between DDMMYY and MMDDYY.</li> </ul> <p><b>To change the time format on the LCD,</b></p> <ul style="list-style-type: none"> <li>• Press <b>TRANS/PGM</b> button.</li> <li>• Dial * <b>6</b></li> <li>• The format toggles between 12-hour mode and 24-hour mode. (YY : year, MM : month, DD : date)</li> </ul>

**Attendant Clock Set**

This feature allows the attendant to set the Time/Date without entering Admin Programming.

Button	Procedure
 TRANS/PGM	<ul style="list-style-type: none"> <li>• Press <b>TRANS/PGM</b> button.</li> <li>• Enter Date as MMDDYY (6 digits) and press <b>HOLD/SAVE</b> button.</li> <li>• Enter Time as military format (4 digits) and press <b>HOLD/SAVE</b> button. If there is no need to change date or time, press HOLD/SAVE button to go to the next step.</li> </ul>





● **aria 20 SERIES DIGITAL KEY TELEPHONE SYSTEM USER GUIDE:**  
**aria 20A, aria 20, aria 20W**

**To Set Current Time 1 Hour Early/Late**

Button	Procedure
	<p><b>To set the current time 1 hour early,</b></p> <ul style="list-style-type: none"> <li>• Press <b>TRANS/PGM</b> button.</li> <li>• Dial * 1.</li> </ul> <p><b>To set the current time 1 hour late,</b></p> <ul style="list-style-type: none"> <li>• Press <b>TRANS/PGM</b> button.</li> <li>• Dial * 2.</li> </ul>

**System Speed Dial**

A group of speed dial numbers can be stored within the system for access by allowed stations. These numbers provide speedy access to often used outgoing CO dialing numbers.

Button	Procedure
 	<p><b>To store system speed numbers,</b></p> <ul style="list-style-type: none"> <li>• Press <b>TRANS/PGM</b> button.</li> <li>• Dial <b>SPEED</b> button.</li> <li>• Dial <u>speed number bin</u>.</li> <li>• Dial the phone numbers to be stored.</li> <li>• Dial <b>HOLD/SAVE</b> button.</li> </ul> <p style="text-align: right;">20/16/20W : 21-99</p>
 	<p><b>Or, speed dial by line number:</b></p> <ul style="list-style-type: none"> <li>• Press <b>TRANS/PGM</b> button.</li> <li>• Dial <b>SPEED</b> button.</li> <li>• Dial <u>speed number bin</u>.</li> <li>• Press desired outside line button.</li> <li>• Dial the phone numbers to be stored.</li> <li>• Dial <b>HOLD/SAVE</b> button.</li> </ul> <p style="text-align: right;">20/16/20W : 21-99</p>
	<p><b>To use system speed numbers,</b></p> <ul style="list-style-type: none"> <li>• Press <b>SPEED</b> button.</li> <li>• Dial <u>speed number bin</u>.</li> </ul>

Attendant Operation

**Attendant Intrusion**

Attendant may intrude into any station which is in conversation with a CO line.

Button	Procedure
	<p><b>To activate attendant intrusion</b></p> <ul style="list-style-type: none"> <li>• Press CO button you wish to converse. (If intrusion is allowed by Admin program, then 3 way conversation is set up. If intrusion is not allowed, busy tone will be heard.)</li> <li>• Requires Installer Programming Settings.</li> </ul>

**Day/Night Mode Service**

The attendant station can be placed into night service mode allowing ring assignments and answering privileges to station not having the privileges in the day mode. In **aria 20/16/20W**, Day/Night mode change is available by pressing DND button at attendant station.

Button	Procedures
	<p><b>To activate/deactivate Day/Night/On-demand mode manually,</b></p> <ul style="list-style-type: none"> <li>• Press <b>DND/FWD</b> button at attendant station.</li> <li>• Then, <b>DND/FWD</b> button is flashing. (The system is in On-demand mode.)</li> <li>• If pressing the <b>DND</b> button one more, then the system is in Night service mode.</li> <li>• On-demand mode is not activated automatically. (Auto Ring Mode – see below)</li> </ul>

**Auto Ring Mode Service**

The system can be placed in Day/Night/Auto Ring mode operation manually by pressing [DND/FWD] button at attendant station. In Auto ring mode, the ring mode will follow the Weekly Time Table in Installer Programming. Available for ver 4.0(**aria 16**) and 3.0(**aria 20W**), all **aria 20**

Button	Procedures
	<p><b>To activate/deactivate Day/Night/Auto Ring mode manually,</b></p> <ul style="list-style-type: none"> <li>• Pressing <b>DND/FWD</b> button, the ring mode is changed to <b>Night</b> → <b>Auto Ring</b> → <b>Day</b> mode in sequence.</li> </ul> <p><b>To activate Auto ring mode with Attendant PGM mode,</b></p> <ul style="list-style-type: none"> <li>• The Weekly Time Table should be entered by Admin Programming</li> </ul>

● **aria 20 SERIES DIGITAL KEY TELEPHONE SYSTEM USER GUIDE:**  
**aria 20A, aria 20, aria 20W**

**To Print out Accumulated SMDR Records**

Station Message Detail Recording(SMDR) can provide details on both incoming and outgoing calls.

Button	Procedures
 HOLD/SAVE	<p><b>For station basis,</b></p> <ul style="list-style-type: none"> <li>♦ Dial <b>TRANS/PGM + * 8 1</b></li> <li>♦ Enter the desired station range.</li> <li>♦ Press <b>HOLD/SAVE</b> button.</li> </ul> <p>Accumulated SMDR records will be printed out through the printer connected to KSU.</p>

Available by Software:  
**aria 16:** Above V4.0  
**aria 20W:** Above V3.0)  
 All **aria 20**

**To Erase SMDR Records**

Button	Procedure
 HOLD/SAVE	<p><b>For station basis,</b></p> <ul style="list-style-type: none"> <li>♦ <b>TRANS/PGM * 8 2</b></li> <li>♦ Enter the desired station range. (SMDR records will be erased for all stations in the range)</li> <li>♦ Press <b>HOLD/SAVE</b> button.</li> </ul>

Available by Software:  
**aria 16:** Above V4.0  
**aria 20W:** Above V3.0)  
 All **aria 20**

**Attendant LCD Language**

Not Currently Supported in New Zealand Software

**Attendant DSS Operation /Placing an Intercom Call from the DSS**

Button	Procedures
	<ul style="list-style-type: none"> <li>♦ Lift handset or press <b>MON</b> button.</li> <li>♦ Press the desired DSS station button.</li> </ul>

**Making a Page**

Button	Procedure
	<ul style="list-style-type: none"> <li>♦ Lift handset or press <b>MON</b> button.</li> <li>♦ Press <b>PAGE</b> button.</li> <li>♦ Speak in normal voice tone to announce message.</li> </ul>

**Transferring an Outside Line to Another Station**

Button	Procedure
	<ul style="list-style-type: none"> <li>♦ While connecting an outside line, press the desired DSS station button.</li> <li>♦ You can wait to announce the transfer</li> </ul>

**Overriding a Key Telephone in Do Not Disturb**

Button	Procedure
	<ul style="list-style-type: none"> <li>♦ Press DSS button of the station to be overridden. (DND tone or busy tone is heard.)</li> <li>♦ Dial * to override the station in DND or in busy.</li> </ul>

Attendant Operation

## Attendant Programming Menu Table

The attendant can program some features with this table by pressing **TRANS/PGM** button then the appropriate codes:

Attendant Main Menu	Attendant Sub Menu-1	Attendant Sub Menu-2	Selection	
[#]	[1] Clock Set		MMDDYY/HHmm	
	[4] System Greeting Recording	[1] System Message	01 - 19	
		[2] System Prompt	1 - 9	
[*]	[1] Set Current Time 1 hr early		- immediate -	
	[2] Set Current Time 1 hr late		- immediate -	
	[5] Date Format		Toggle DDMMYY / MMDDYY	
	[6] Time Format		Toggle 12 hr / 24 hr	
	[7] DVIB	[1] Date Time Order		Date/Time or Time/Date
		[2] Retrieval Order		FIFO or LIFO
		[3] Check Time Status		avail. Record time (Hrs / Sec)
		[4] Check Number Status		avail. Msg number (yyy sec x nnn msg)
		[6] Delete Station Message		Station Range
	[8] SMDR	[1] SMDR Print		Station Range
[2] SMDR Delete			Station Range	
[3] Abort SMDR Print			Press Hold	

### Placing an Outside Call

- Lift handset.
- Dial 1.
- Dial the desired number.

### Placing an Outside Call via CO Group Access

- Lift handset.
- Dial 8 and CO group number. (1~4)
- Dial the desired number.

### Placing an Outside Call via CO Individual Access

- Lift handset.
- Dial 8 8 and CO line number: aria 20 & 16: 1~6, aria 20W: 1~8
- Dial the desired number.

### Placing an Intercom Call

- Lift handset.
- Dial intercom number.

### Placing an Outside Call on Hold

- While connected to an extension call, briefly depress and release the hook switch ('flash' the hook switch)
- Dial 59

### Group Call Pick-up

When hearing an unattended phone ringing in your area,

- Lift handset.
- Dial 6 6
- You will be connected to an extension or outside line call.

### Message Waiting (Callback)

#### To Leave a Missed Call Message Indication (Idle Station):

- Lift handset.
- Dial the desired extension number.
- No reply from a key station.
- 'Flash' the hook switch.
- Dial 5 6
- Hang up.

#### To Leave a Missed Call Message Indication (Busy Station):

- Lift handset.
- Dial the desired extension number.
- busy tone from a SLT or key station.
- 'Flash' the hook switch.

• Dial 5 7

#### To Retrieve a Message Wait Indication (Callback):

- Lift handset.
- Dial 5 7

Your SLT calls the station which left the callback.

#### To Leave a Callback indication at a busy station:

- Lift handset.
- Dial the desired extension number.
- busy tone from a SLT or key station.
- 'Flash' the hook switch.
- Dial 5 6

Your SLT calls the station which left the Callback.

### Call Wait (Camp-on)

- After receiving intercom busy tone, 'flash' the hook switch and dial \*)
- Camp-on tone is heard in the called station.
- The called station receives the ringing from camped on call when hanging up from original call. **CO Line Hold**

#### To place a CO call on hold:

- Hook-flash and dial 5 9

#### To recall a CO call on hold:

- Lift Handset
- Dial 8 # #

### Answering a Waiting Call

- You will receive warning tone in handset.
- Hang up the present call to take a new one.

### Making a Screened Transfer

- While connected to an outside line, 'flash' the hook switch.
- Dial the desired extension number and wait to be answered.
- Announce the call.
- Hang up to complete call transfer.

### Making an Unscreened Transfer

- While connected to an outside line, 'flash' the hook switch.
- Dial the desired extension number
- Hang up to complete call transfer.

### Last Number Redial

- Lift handset.
- Dial 5 2

### Storing Station Speed Dial Numbers

- Lift handset.
- Dial 5 5
- Dial speed dial number: 01~20.
- Dial speed dial number you wish to store.
- 'Flash' the hook switch.
- You will hear confirmation tone and hang up.

### Using Speed Dial Numbers

- Lift handset.
- Dial 5 8
- Dial the desired Station Speed Dial Number: 01~20.  
OR the System Speed Dial Number: 21~99

### Establishing a Conference Call

The system allows you to set up a 3-way conference call.

- Lift handset.
- Call the desired party. (outside or internal)
- 'Flash' the hook switch.
- Dial the internal extension number.
- When the other party answers, 'flash' hook switch twice in 2 seconds. (All three parties are now connected.)

### Call Forward

- Lift handset.
- Dial 5 4
- Dial the desired call forward number.
 

1 - Unconditional,	2 - Busy calls
3 - No answer calls,	4 - Busy/no answer calls
5 - Station off-net	# - Cancel previous forward
6 - Incoming outside line to off-net (ATD Only)	
7 - DVU forward for no answer/busy	
- Dial the station / group number to forward calls to.
  - aria 20A & 20:* 700~720 / 61~64
  - aria 20W:* 700~733 / 61~64
  - aria 16A & 16:* 700~715 / 61~64
- Hang up.
- To cancel Call Forward, lift handset and dial 5 4 and #.

### Paging

- Lift handset.
- Dial the desired page zone number.
- Give your message.
- Hang up to complete paging.
 

<i>Page Zones:</i>	
Call All zones:	# 0
Call All Internal zones:	# 4
Internal zone 1 :	# 1
Internal zone 2 :	# 2
Call external zone :	# 3

### **Voice Announcement**

#### **Recording Your Message;**

- ♦ Lift handset.
- ♦ Dial **5 4 + 7 + #** .
- ♦ Record your message.
- ♦ Replace the handset.

*NB:* Call Forward to DVU is automatically enabled after recording your greeting.

#### **Deleting Your Message;**

- ♦ Lift handset.
- ♦ Dial **5 4 + 7 + \*** .
- ♦ Replace the handset.

#### **To hear the recorded Message,**

- ♦ Dial **5 7** .
- ♦ Time & date prompt for the recorded message is provided then voice message is played.
- ♦ Hang up. (The message is deleted automatically.)

#### **Activate Call Forward to DVU,**

- ♦ Lift handset
- ♦ Dial **5 4 + 7** .
- ♦ Go on-hook.

#### **Deactivate Call Forward to DVU,**

- ♦ Lift handset.
- ♦ Dial **5 4**
- ♦ Dial **#**.
- ♦ Go on-hook.

### **“Meet Me” Paging**

When hearing a paging announcement,

- ♦ Dial **# 6**

### **Returning Call to Host System**

#### **(FLASH to Line Feature)**

If your **aria** system is connected to another system, you can use this feature to transfer a call back to an extension on the other system.

(Your installer will tell you if you need this feature.)

- ♦ While connected to an extension call, **‘flash’** the hook switch.
- ♦ Dial **5 1**
- ♦ Hearing new dial tone from the other system, dial the extension number on the required system.
- ♦ When the station answers, (See Screened Transfer) speak or hang up (See Unscreened Transfer) to transfer the call.

### **Do Not Disturb (DND)**

- ♦ Lift handset.
- ♦ Dial **5 3**
- ♦ Place the handset.

#### **To cancel Do Not Disturb,**

- ♦ Lift handset.
- ♦ Dial **5 3**.

### **Shuttle Call**

- ♦ An extension user engaged in an internal or external call, should briefly press hook switch to hold a call (**‘flash’** the hook switch).
- ♦ The holding party hears music on hold. (If equipped)
- ♦ Dial the second number of another internal or external call.
- ♦ When the second call is connected, the extension user may alternate the call between holding parties by **‘flashing’** the hook switch.
- ♦ Then, you may make a conference by **‘flashing’** the hook switch.

### **Programming a Name for an SLT**

- ♦ Lift Handset
- ♦ Dial **5 8** (confirmation tone is heard)
- ♦ Dial **0 0** (confirmation tone is played again)
- ♦ Enter the name using the table on page 10 (max of 7 letters)
- ♦ **‘flash’** the hook switch

### **Call Park**

While on a CO call:

- ♦ **‘flash’** the hook switch
- ♦ Dial the park number (601-606)
- ♦ Hang up the phone.

### **Retrieve a Parked Call**









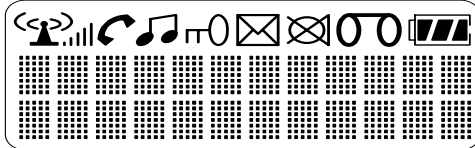





- ♦ Dial the Park Location (601-606)
- ♦ You are connected to the calling party

## 20W Dect Supplement

### GDC-340 LCD Display







The LCD of GDC-340H GAP has eight icons and 2 x 12 Dot matrix. The LCD shows different wireless states and displays visual feedback for the actions performed by user.



Icon	Description
	 <p><b>Blinking</b> : When the icon is blinking, the terminal is still not locked to a base station and the location registration is not finished either.</p>
	 <p><b>Steady</b> : When it stops blinking, the terminal is locked to a base station but the location registration is not finished.</p>
	 <p>Location registration is finished. Even though user may make a call or receive a call, may hear very severe noise. (Below -86dBm)</p>
	 <p>Even though user may make a call or receive a call, may hear severe noise. (-85dBm~-79dBm)</p>
	 <p>User may make a call or receive a call and may hear some noise. (-78dBm~-73dBm)</p>
	 <p>User may make a call or receive a call and the call quality is normal. (-72dBm~-65dBm)</p>
	 <p>User may make a call or receive a call and the call quality is good. (Upper -64dBm)</p>
 <p>- <b>Blinking</b> : Indicates that a call connection is being tried.                      - <b>Steady</b> : Indicates that a traffic channel is established.</p>	
 <p>Indicates that the phone is set to lock mode.</p>	
 <p>The icon indicates that the system has at least one new message for the wireless terminal. The message information is updated every 3 minute. The disconnection with the subscribed system makes impossible to update the message information and the icon is disappeared. And if the wireless terminal is connected with the system, this icon is displayed again on the LCD. If the station message is left, <u>the reserved call is made by using CALLBACK button</u> and this icon will be disappeared after the call. In case of voice message through DVU, press <b>FLASH</b> button to delete a message after checking the message. When all messages are deleted, the message icon will be disappeared. Otherwise, this icon will be still remained. Applicable message: DVU message, CLI message, Station message</p>	
 <p>Indicates that during a call, you can prevent the other party from hearing any background noise or conversations, by pressing the <b>DOWN</b> button longer than 1 second.</p>	
 <p>Indicates charge level of the battery.</p>	
 <p>Indicates that the phone is tone mode.</p>	





**GDC-340 Button Function**

Button Icon	Function	Description
	[ON/OFF]	- Try to make/release call
	[FLASH/CLEAR]	- Talking Mode : Register recall - Flash a call and retry next call - When using pre-dial : ■ Pressing longer than 1 second : All digits are cleared ■ Pressing shorter than 1 second : 1 digit backspace ■ When using local functional operation : Function cancel (It should be pressed longer than 1 second)
	[REDIAL/PAUSE]	- Pressing shorter than 1 second ■ Pre-dial : Redial number saved in handset. ■ Post-dial : Redial number saved in system. - Pressing longer than 1 second ■ Pause(pre-dial, post-dial and during CO-line call).
	[OK/SPEED/FUNCTION]	- Standby Mode : Select / Finish a local function(OK). - Post-Dial : ■ Pressing shorter than 1 second : System speed dial(SPEED). ■ Pressing longer than 1 second : Start / Finish a system function(FUNCTION).
	[TRANSFER/INTERCOM/INTERNAL/HOLD]	- Talking Mode : ■ Pressing shorter than 1 second : Transfer a call to the other station(TRANS). ■ Pressing longer than 1 second : Hold a call / release a holding call(HOLD). - In an idle state : ■ Home DECT : Internal call ■ Key-telephone DECT : Trying to make a CO line call or an intercom call
	[POWER/CALL BACK]	- Power-on - Pressing longer than 1 second : Power Off - Pressing shorter than 1 second : Leave a call back or a message
	[UP/DOWN/MENU]	- When using local functional operation : Start a local function, upper / lower scroll - Talking Mode : Up / Down the level of Rx volume, Call by name, CLIP - Navigate and select among function items in a menu or submenu

DECT SUPPLEMENT

● **aria 20 SERIES DIGITAL KEY TELEPHONE SYSTEM USER GUIDE:**  
**aria 20A, aria 20, aria 20W**

**GDC-340 Button Function (cont)**

Button Icon	Function	Description
		- Go to Pulse (Pressing longer than 1 second) - '#' Display (Pressing shorter than 1 second)
		- Talking Mode (Only when the Camp-On function is supported by GDK & LDK series) : Camp-On - Standby Mode : <ul style="list-style-type: none"> <li>■ '*' is displayed (Pressing shorter than 1 second)</li> <li>■ Go to DTMF (Pressing longer than 1 second)</li> </ul>
<b>0~9</b>		- Standard dial button

**aria 20W DECT Features (GDC-340/ 345 shown)**

DECT SUPPLEMENT

FEATURE	INPUT KEY	
Call Transfer	(During a call) <b>[TRANS]</b> + STA # + <b>ON/OFF</b> (☞)	
Call Waiting/Camp On	<b>ON/OFF</b> (☞) + STA # + (if busy tone is heard) *	
Call Back	<b>ON/OFF</b> (☞) + STA # + <b>[CALL BACK]</b>	
Attendant Call	<b>ON/OFF</b> (☞) + 0 or <b>ON/OFF</b> (☞) + 9	
Paging	All Call	<b>ON/OFF</b> (☞) + # + 0
	Internal Zone 1	<b>ON/OFF</b> (☞) + # + 1
	Internal Zone 2	<b>ON/OFF</b> (☞) + # + 2
	External	<b>ON/OFF</b> (☞) + # + 3
	Meet-me Page	<b>ON/OFF</b> (☞) + # + 6
DND (Do Not Disturb, Toggle)	<b>ON/OFF</b> (☞) + 5 + 3	
Call Forward	Unconditional	<b>ON/OFF</b> (☞) + 5 + 4 + 1 + STA #
	Busy Calls	<b>ON/OFF</b> (☞) + 5 + 4 + 2 + STA #
	No Answer Calls	<b>ON/OFF</b> (☞) + 5 + 4 + 3 + STA #
	Busy/No Answer Calls	<b>ON/OFF</b> (☞) + 5 + 4 + 4 + STA #
	Station Off-net	<b>ON/OFF</b> (☞) + 5 + 4 + 5 + SPD BIN #
	DVIB	<b>ON/OFF</b> (☞) + 5 + 4 + 7
Call Forward Cancel	<b>ON/OFF</b> (☞) + 5 + 4 + #	
Call Pilot Number	<b>ON/OFF</b> (☞) + digit (61~64)	
Group Call Pick Up	<b>ON/OFF</b> (☞) + 6 + 6	
Universal Night Answer	<b>ON/OFF</b> (☞) + 6 + 9	
CO Group Access	<b>ON/OFF</b> (☞) + 8 + digit (1~4)	
Individual CO Line Access	<b>ON/OFF</b> (☞) + 8 + 8 + digit (1~8)	
System Speed Dial	<b>ON/OFF</b> (☞) + <b>[SPEED]</b> + digit (01~19)	
Last Number Redial	<b>ON/OFF</b> (☞) + <b>[SPEED]</b> + * or <b>[REDIAL]</b> (☞) (This case is available only for CO line call.) <b>[REDIAL]</b> (☞) + <b>[ON/OFF]</b> (☞)	
Station Program Recovery	<b>ON/OFF</b> (☞) + <b>[FUNCTION]</b> + 2 + 5	
Wake-Up Call	Set function	<b>ON/OFF</b> (☞) + <b>[FUNCTION]</b> + 4 + 1 + Time(hh:mm) + (# for permanent use) + <b>[FUNCTION]</b>
	Reset function	<b>ON/OFF</b> (☞) + <b>[FUNCTION]</b> + 4 + 2 + <b>[FUNCTION]</b>

**GDC-340 Handset Menu**

**USER MENU TREE**

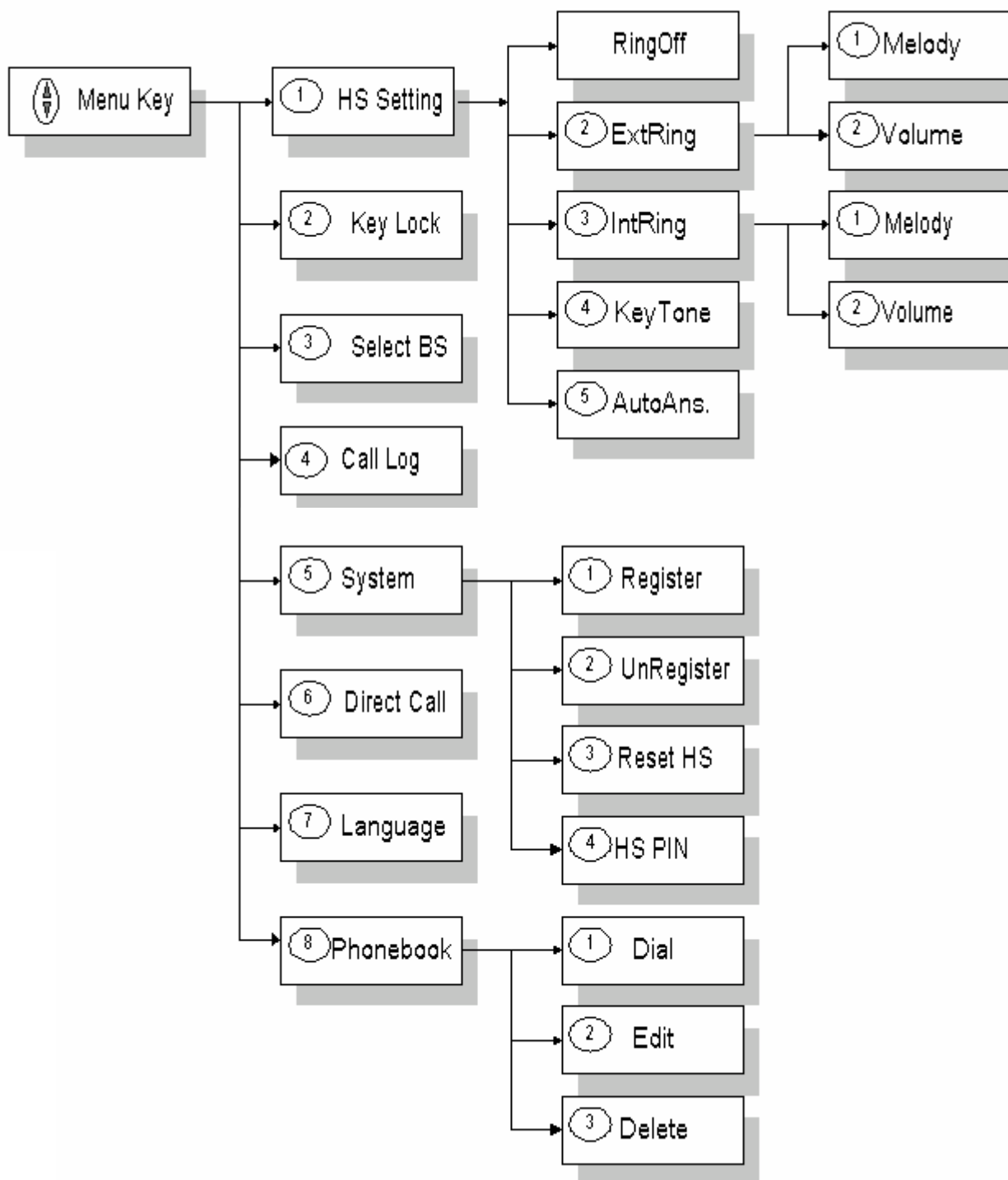

**DECT SUPPLEMENT**

Notes : 1. When you go back to previous menu, press 'C/R' key.  
 2. When you go back to 'Idle State', press 'C/R' key more than 1 second.

## Free Manuals Download Website

<http://myh66.com>

<http://usermanuals.us>

<http://www.somanuals.com>

<http://www.4manuals.cc>

<http://www.manual-lib.com>

<http://www.404manual.com>

<http://www.luxmanual.com>

<http://aubethermostatmanual.com>

Golf course search by state

<http://golfingnear.com>

Email search by domain

<http://emailbydomain.com>

Auto manuals search

<http://auto.somanuals.com>

TV manuals search

<http://tv.somanuals.com>