



VACUUM CLEANER

SERVICE MANUAL

CAUTION

BEFORE SERVICING THE UNIT, READ THE "SAFETY PRECAUTIONS"
IN THIS MANUAL.

MODEL: V-C7050NT, V-C7050HT
V-C7070CT, V-C7070CP

CONTENTS

SAFETY PRECAUTIONS	3
CAUTIONS.....	3
DESCRIPTION	4
SPECIFICATIONS.....	4
DISASSEMBLY	5
TROUBLE SHOOTING	6
BLOCK DIAGRAM.....	9
SCHEMATIC DIAGRAM	9
CIRCUIT DIAGRAM	9
EXPLODED VIEW	13
REPLACEMENT PARTS LIST	17
APPENDIX	19
1. THE TYPE OF POWER CORD & PARTS NUMBER	19
2. COLOR & PARTS NUMBER.....	20
3. MOTOR & PWB ASSY PARTS NUMBER	20

SAFETY PRECAUTIONS

BEFORE OPERATING THIS VACUUM CLEANER, READ THIS SERVICE MANUAL THOROUGHLY, AND OBSERVE EACH POINT CAREFULLY.

1. Motor filter(Air Cleaner)

- 1) This filter is reusable.
- 2) Never use the vacuum cleaner without filter. It may damage the motor.
- 3) When the light of body is on, wash the motor filter with water and brush.
- 4) Even if the light is not on, wash the motor filter at least once 6 months.

NOTE : Reusing of the motor filter.

- Never wash the filter in a washing machine or in a dishwasher.
- Never use hot water for washing the filter.
- Reuse the filter after drying it completely in the shade for a day.
- Do not dry near fire or direct sunray.

2. Exhaust filter(Washable HEPA filter)

- 1) This filter is reusable HEPA filter.
- 2) For clean air, this filter must be assembled.
- 3) Wash the exhaust filter with water once a year.

NOTE : Reusing of the exhaust filter.

- Never wash the filter in a washing machine or in a dishwasher.
- Never use hot water for washing the filter.
- Reuse the filter after drying it completely in the shade for a half day.
- Do not dry near fire or direct sunray.
- Do not brush the filter. This will cause permanently damage allowing dust to by-pass the filter.

3. Avoid suction such materials as :

- 1) Liquid or wet dust :
Clogs the ventilation holes, reduces the suction power significantly and harms the motor.
- 2) Inflammable liquids such as benzene, alcohol or solvents.
- 3) Burning objects such as cigarette butts.
- 4) Bulky objects such as vinyl, paper etc.
- 5) Sharp objects such as needles, pins, metal, glass particles etc.

4. Attachments

- Nozzle : For cleaning wooden floor, the room floor and carpet.
- Dusting Brush and Crevice Tool:
For cleaning any crevice, inside corners of window frames.
For delicate vacuuming of fabrics on the furniture, curtains, etc.
- Upholstery Nozzle : For vacuuming the dust on the upholstery.

However, do not use the crevice tool more than 20 minutes because it may cause harm to the motor.

5. Close supervision is necessary when this vacuum cleaner is used by or near children. Children's carelessness may cause damage to the cleaner or injure persons.

6. Air exhausted from the vacuum cleaner is normally warm. But if extraordinarily hot air is exhausted, check if the telescopic tube, hose or clean filter is clogged or not.

7. Electric shock could occur if used outdoors or on wet surfaces.

CAUTIONS

BEFORE ATTEMPTING TO SERVICE OR ADJUST ANY PART OF THE VACUUM CLEANER, DISCONNECT THE ELECTRICAL POWER SUPPLY CORD FROM THE WALL OUTLET.

1. Motor exchange

- 1) Separate the Body Cover and Body Base by unfastening the screws.
- 2) After disconnecting the lead wires, replace the old motor with a new one.

2. In case of exchanging other parts. refer to the exploded view.

DESCRIPTION

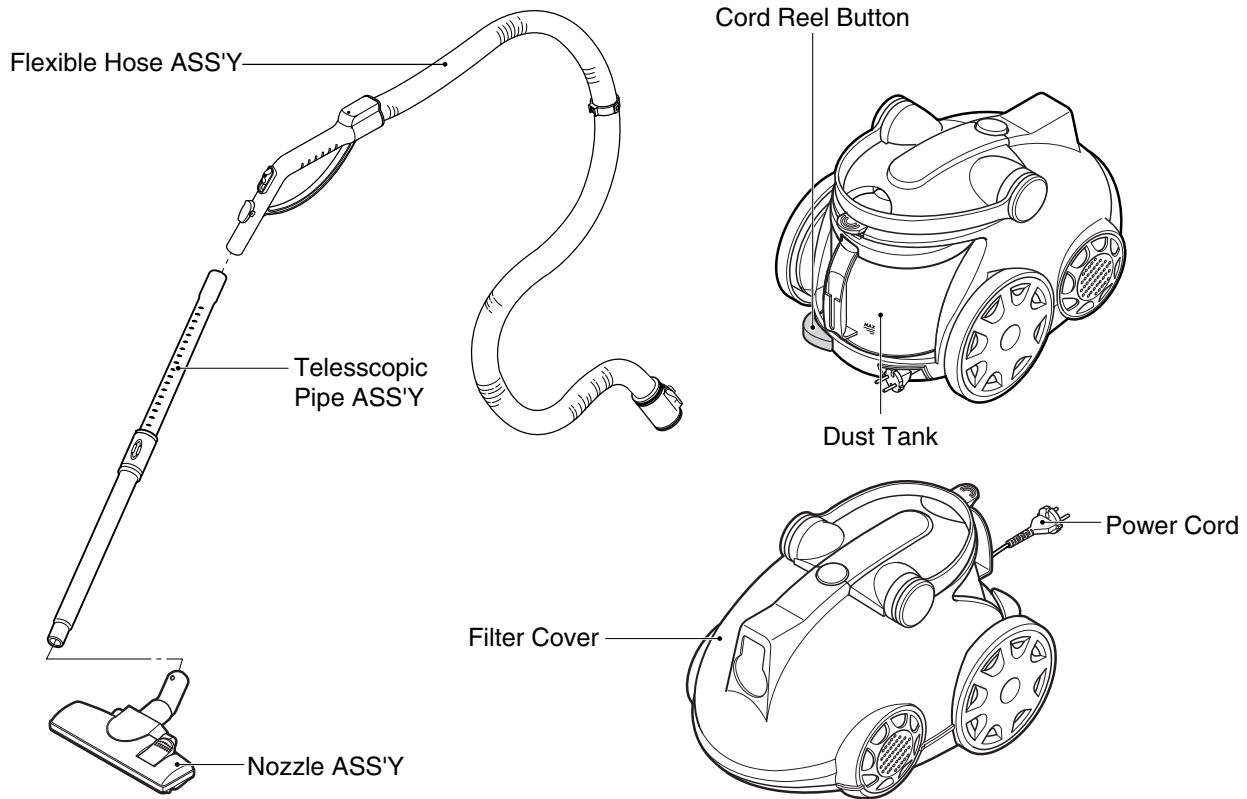

CANISTER

ATTACHMENTS

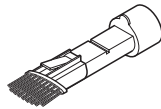

DUSTING BRUSH & CREVICE TOOL

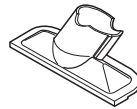

UPHOLSTERY NOZZLE

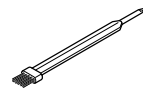

BRUSH ASS'Y

SPECIFICATIONS

- **MODEL** : REFER TO THE COVER PAGE
- **POWER SOURCE** : ON RATING PLATE
- **POWER CONSUMPTION** : ON RATING PLATE
- **POWER CONTROL** :
 - **MAIN** : SLIDE CONTROL (F/HOSE)
(V-C7050HT)
MICOM CONTROL (F/HOSE)
(V-C7070CT)
PUSH ON/OFF(BODY)
(V-C7050NT)
 - **SUB** : VACUUM POWER ADJUSTMENT BY
SLIDE KNOB (V-C7050NT)
- **CORD LENGTH** : 7m
- **HOSE LENGTH** : 1.8m
- **NET WEIGHT** : 5.3Kg
- **PACKING WEIGHT** : 8.4Kg
- **NET DIMENSION** : 290 × 443 × 311(W × D × H)mm
- **PACKING DIMENSION** : 330 × 567 × 385(W × D × H)mm
- **ATTACHMENTS**

HOSE	1EA
TELESCOPIC PIPE ASSY	1EA
NOZZLE ASSY	1EA
DUSTING BRUSH & CREVICE TOOL.....	1EA
UPHOLSTERY NOZZLE	1EA
BRUSH ASS'Y	1EA

• This specifications are subject to change according to the buyer's request.

DISASSEMBLY

NOTE: Before attempting to service or adjust any part of the vacuum cleaner, disconnect the electrical power supply cord from the wall outlet.

- Almost all the parts of this vacuum cleaner can be disassembled with a screw driver and each connecting component easily fits each other. Disassemble one by one referring to the exploded view.
- If possible, don't disassemble except for the necessary parts. It is not necessary to disassemble the parts that are not detailed in the exploded view.

1. Body Cover Assembly Replacement

- 1) Remove the dust tank from the set.

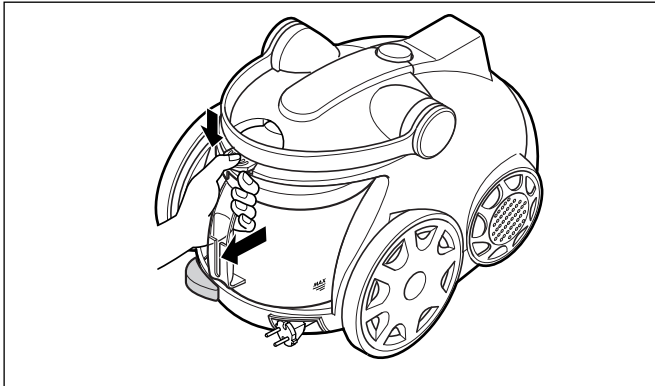

- 2) Remove the four screws fastening the body base.

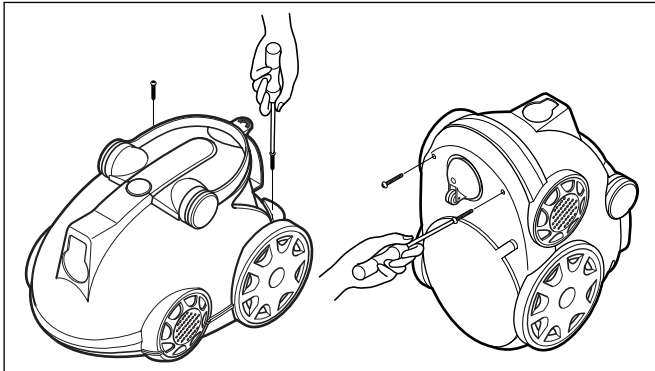

- 3) Disassemble the filter cover, widening the both of filter cover, and then pull out the lead wires from the push switch.

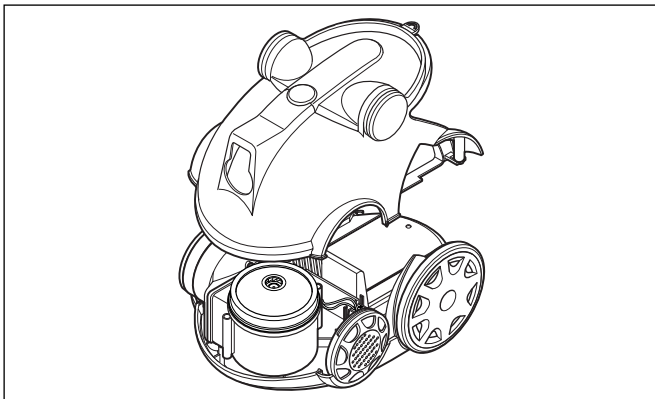

2. Motor Assembly Replacement

- 1) Unhook the motor housing cover in the direction of the arrow.

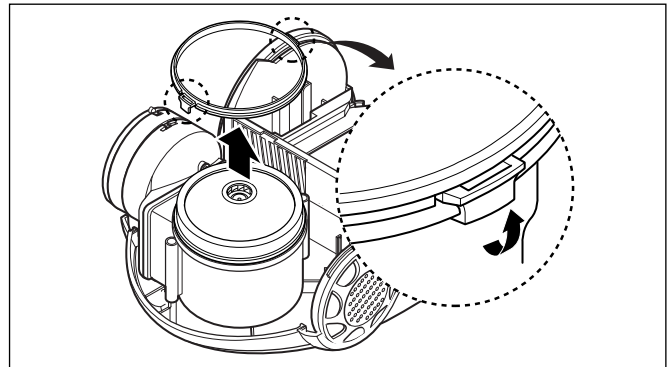

- 2) Bring out the motor and disconnect the lead wires from it.

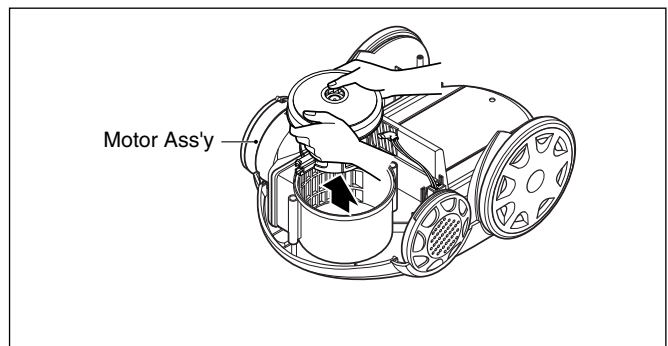

3. Cord Reel Assembly Replacement

- 1) Remove the cord reel cover by unfastening the screw.

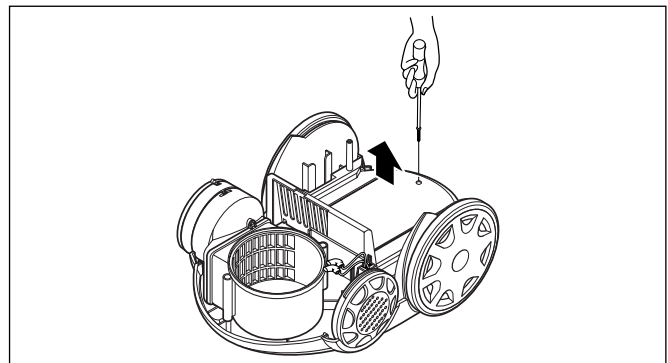

- 2) Lift the cord reel assembly from the body base.

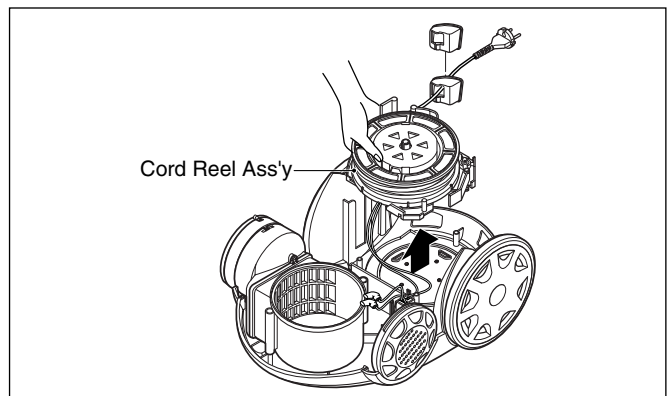

TROUBLE SHOOTING

1. SWITCH ON BUT MOTOR DOES NOT TURN

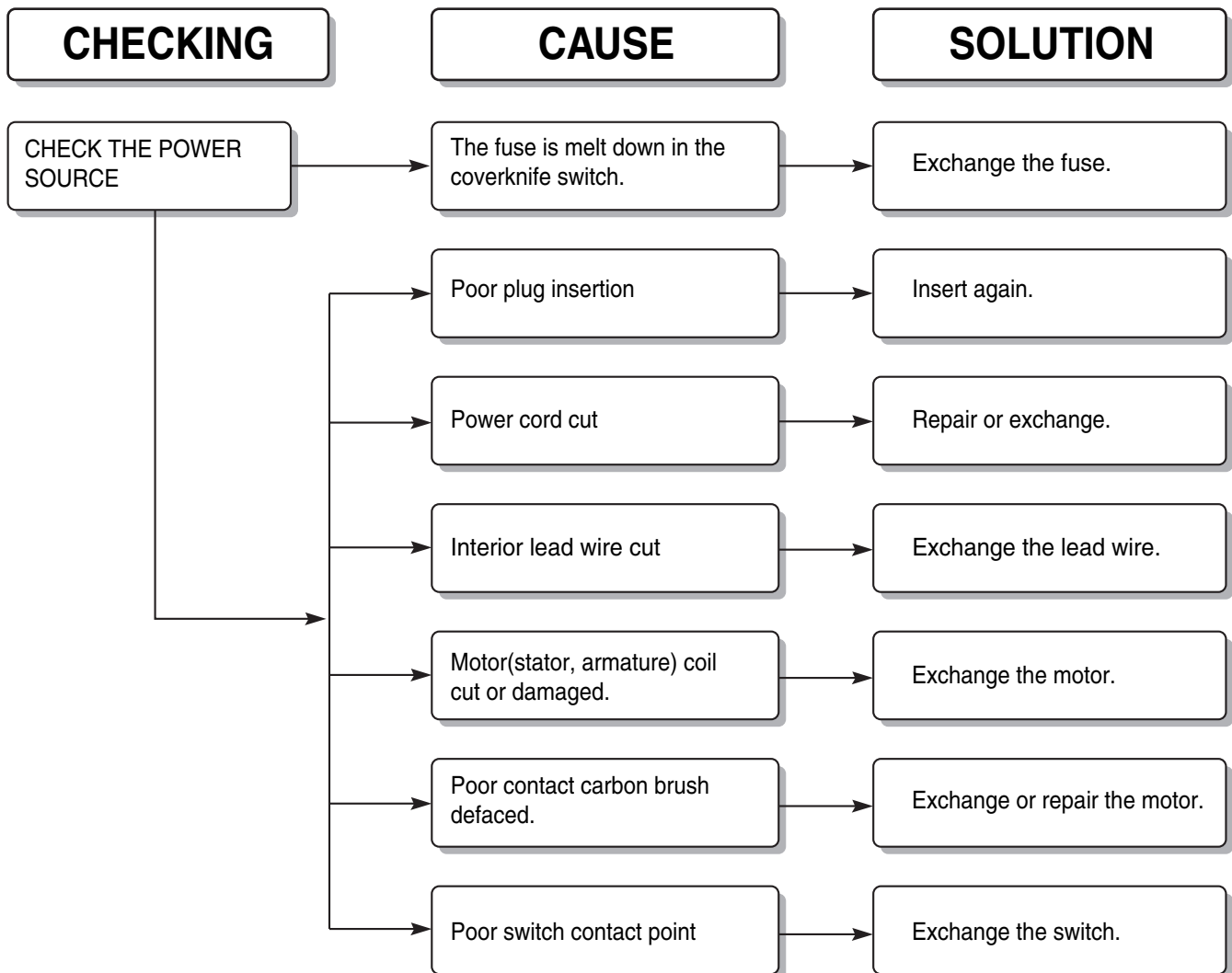

2. SWITCH ON, MOTOR DOES NOT TURN BUT BUZZES

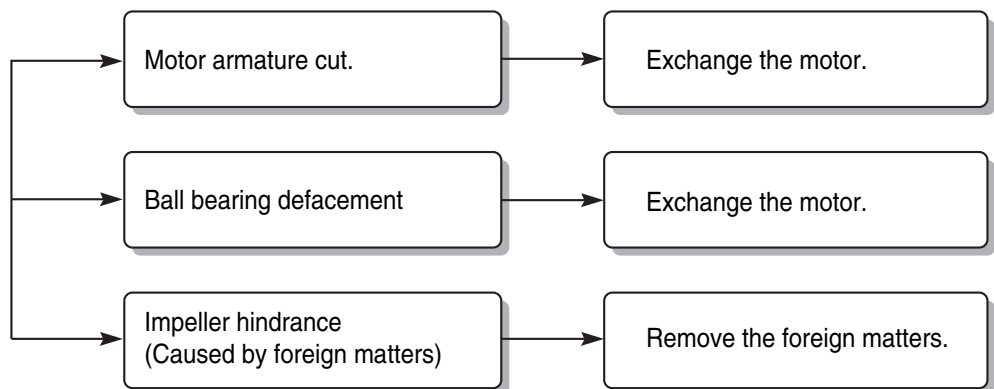

3. SWITCH OFF BUT MOTOR TURNS

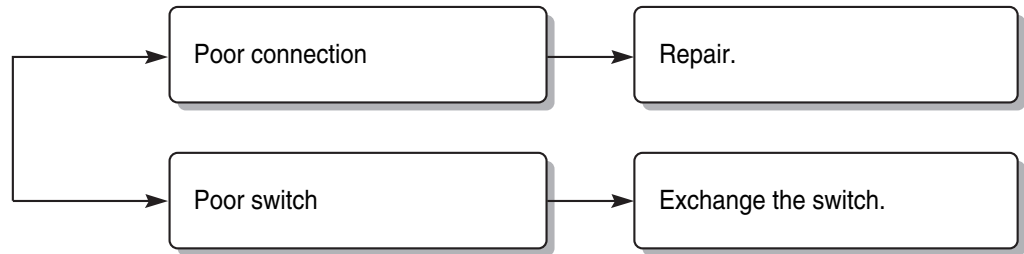

4. WEAK SUCTION POWER

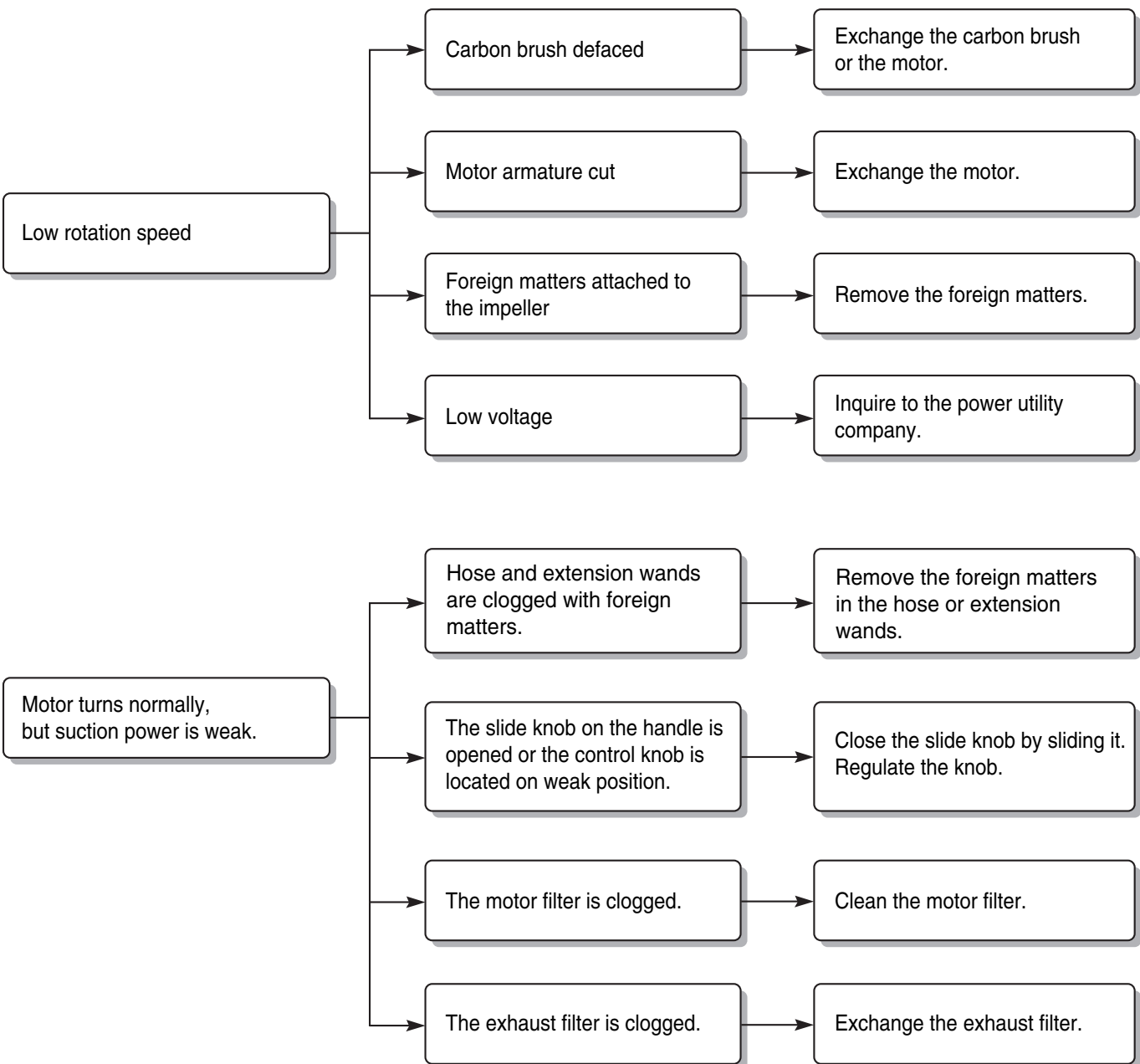

5. VIBRATION NOISES

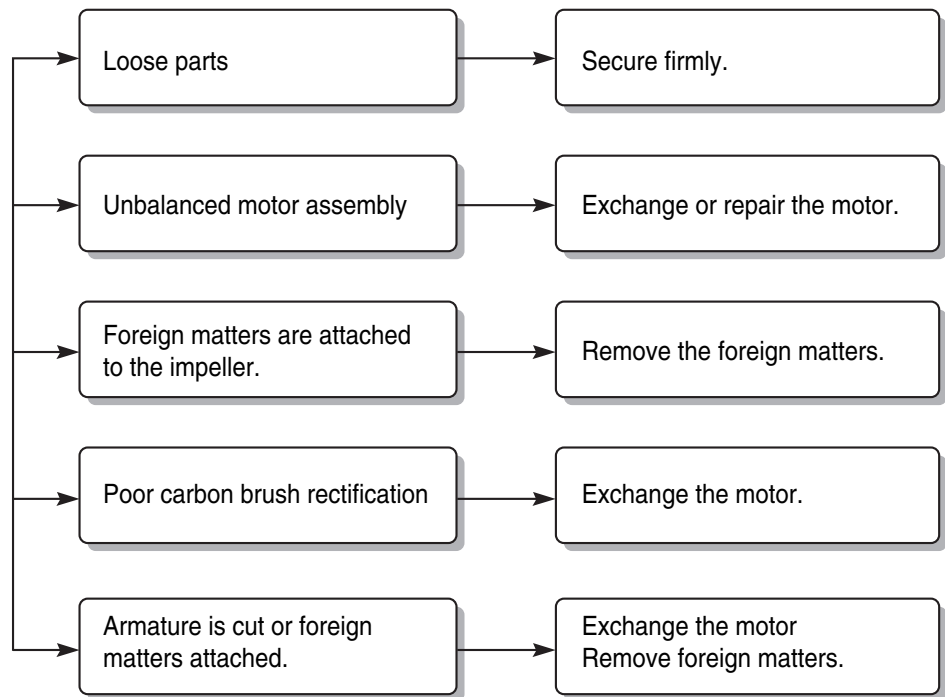

6. RADIO, TV RECEPTION DISTURBANCE

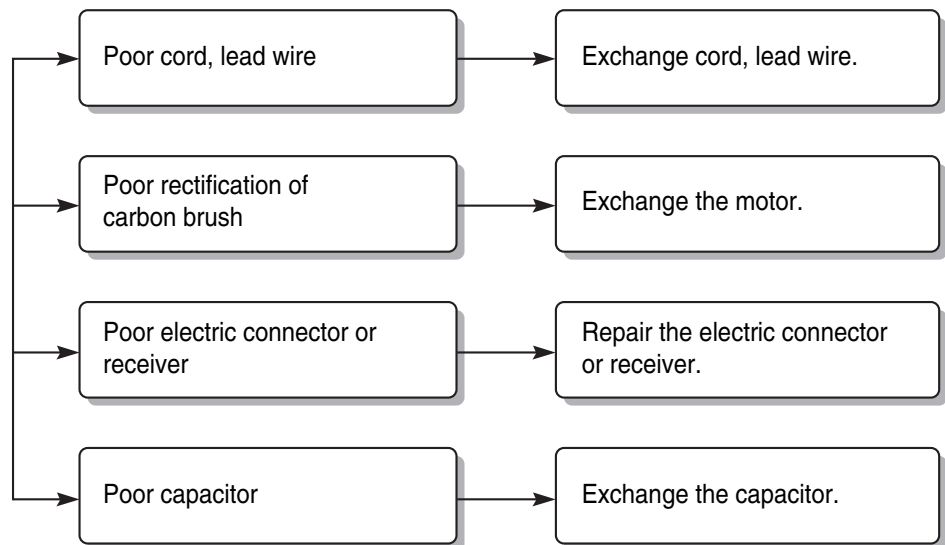

7. IMPROPER TUBE OR NOZZLE CONNECTION

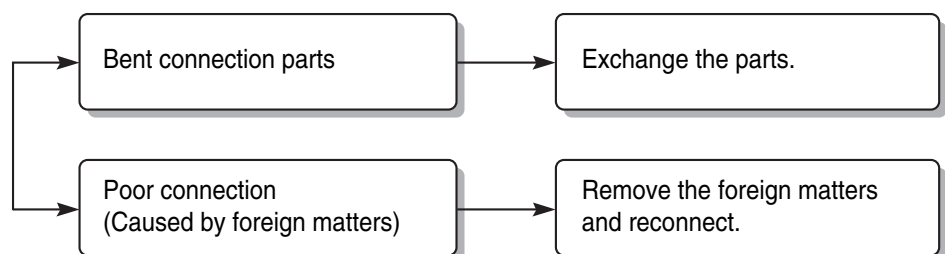

BLOCK DIAGRAM

(V-C7050NT)

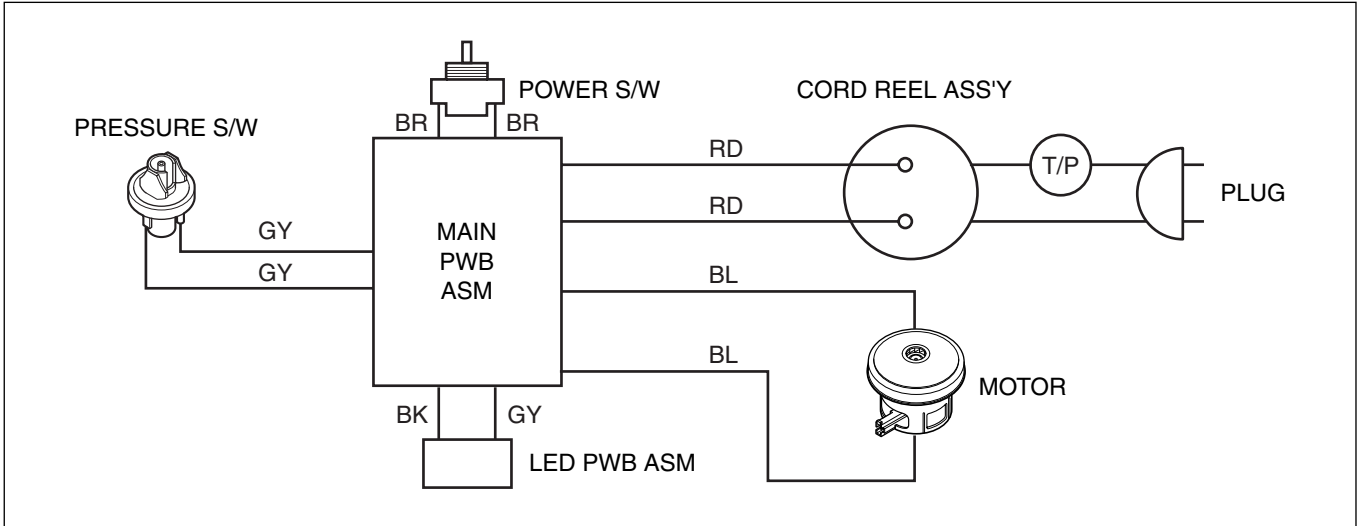

SCHEMATIC DIAGRAM

(V-C7050NT)

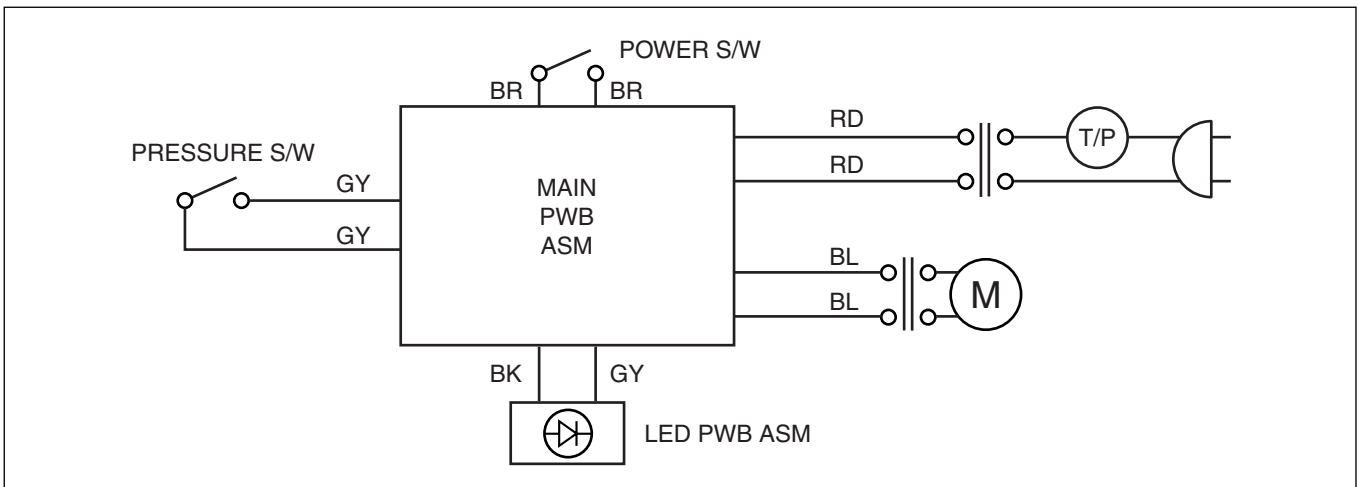

CIRCUIT DIAGRAM

(V-C7050NT)

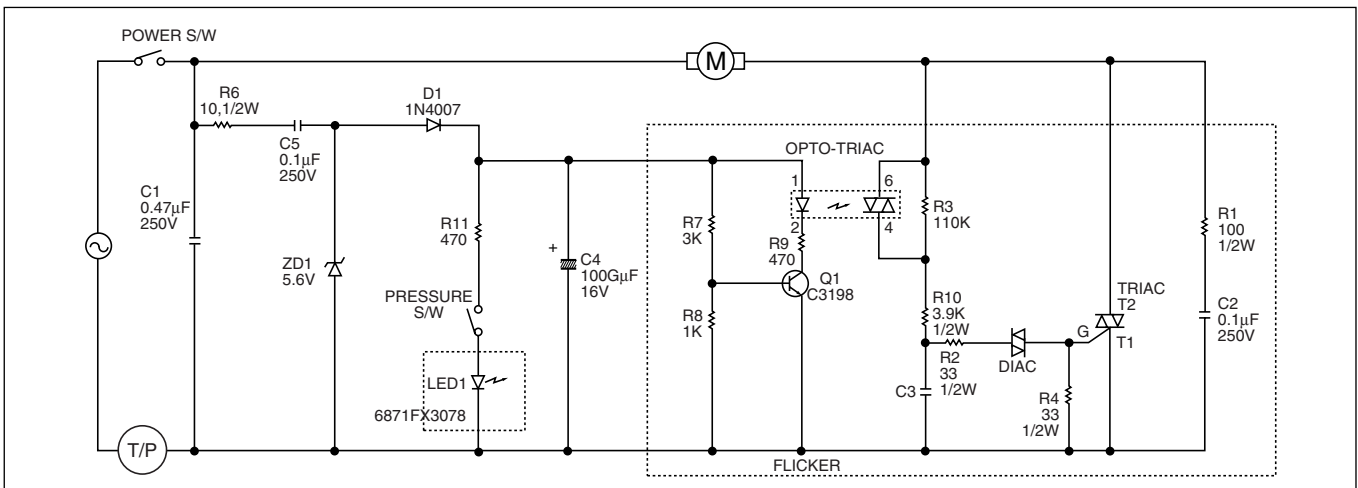

BLOCK DIAGRAM

(V-C7050HT)

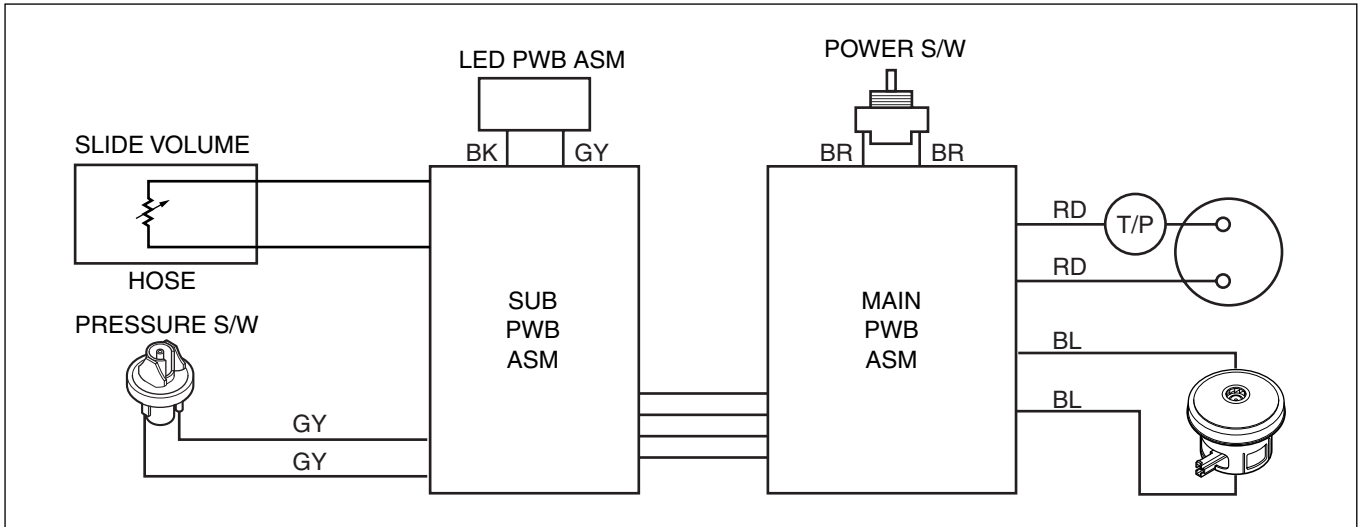

SCHEMATIC DIAGRAM

(V-C7050HT)

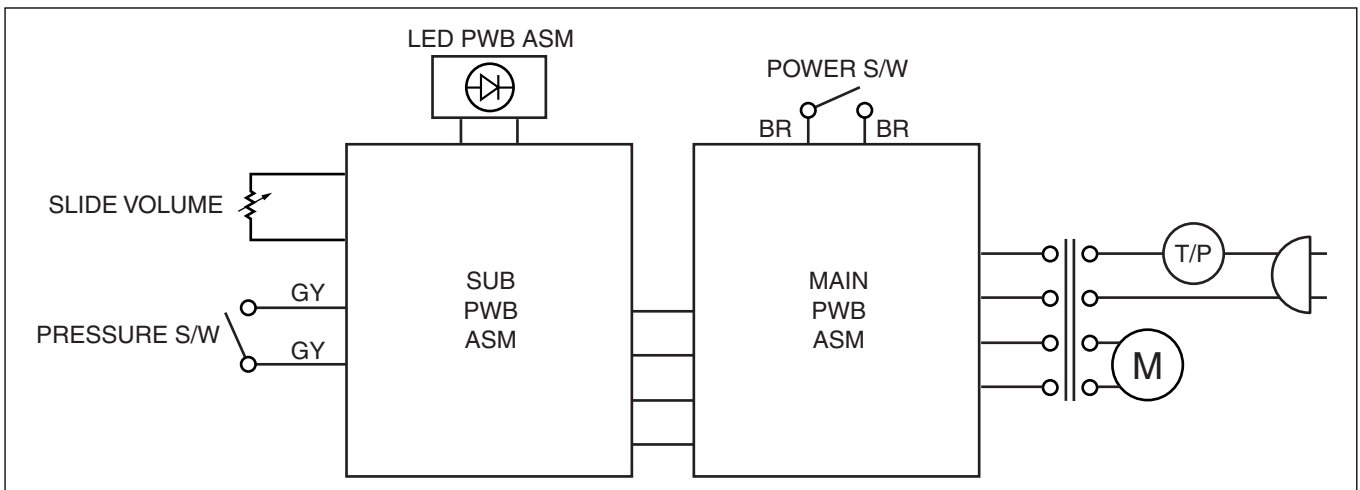

CIRCUIT DIAGRAM

(V-C7050HT)

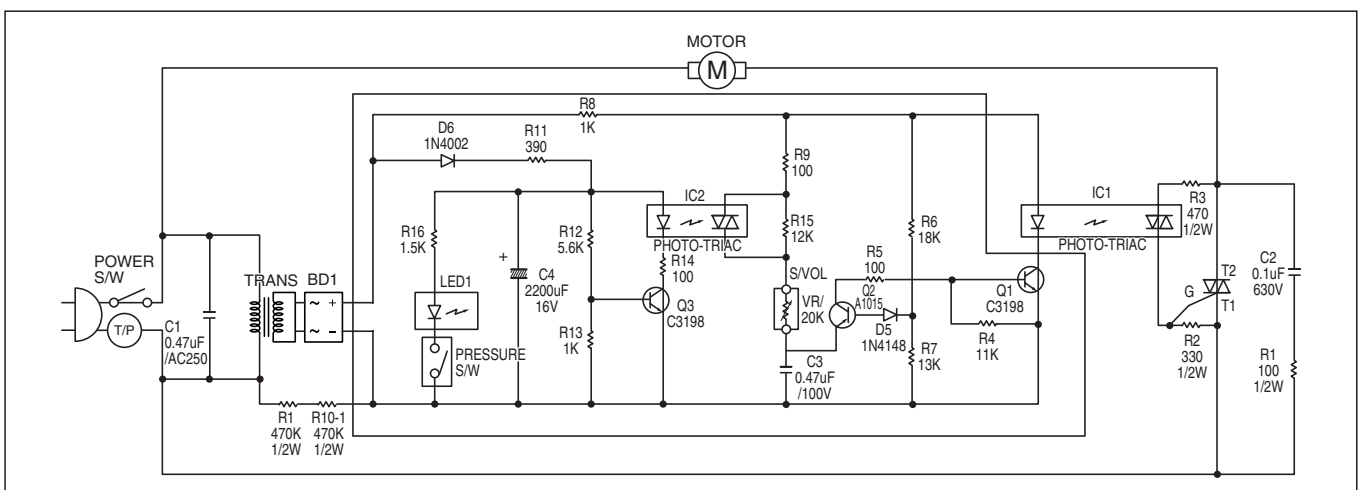

BLOCK DIAGRAM

(V-C7070CT)

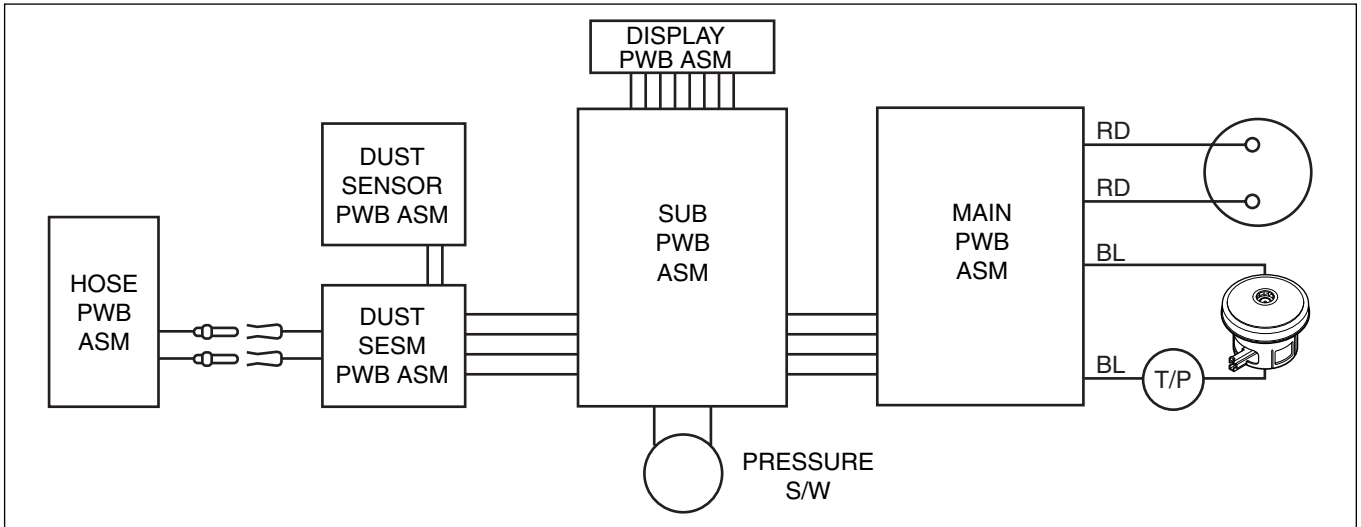

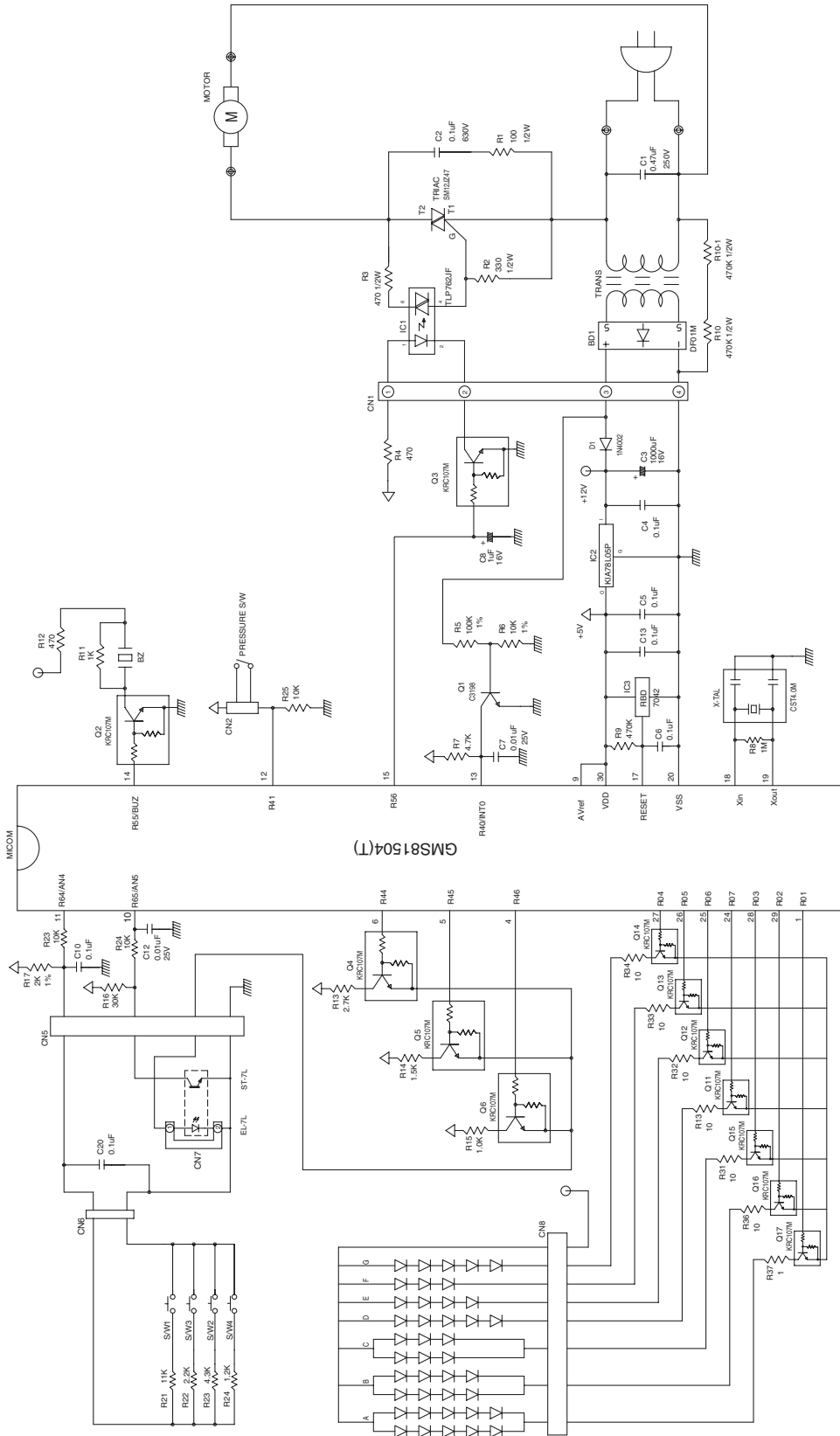

EXPLODED VIEW

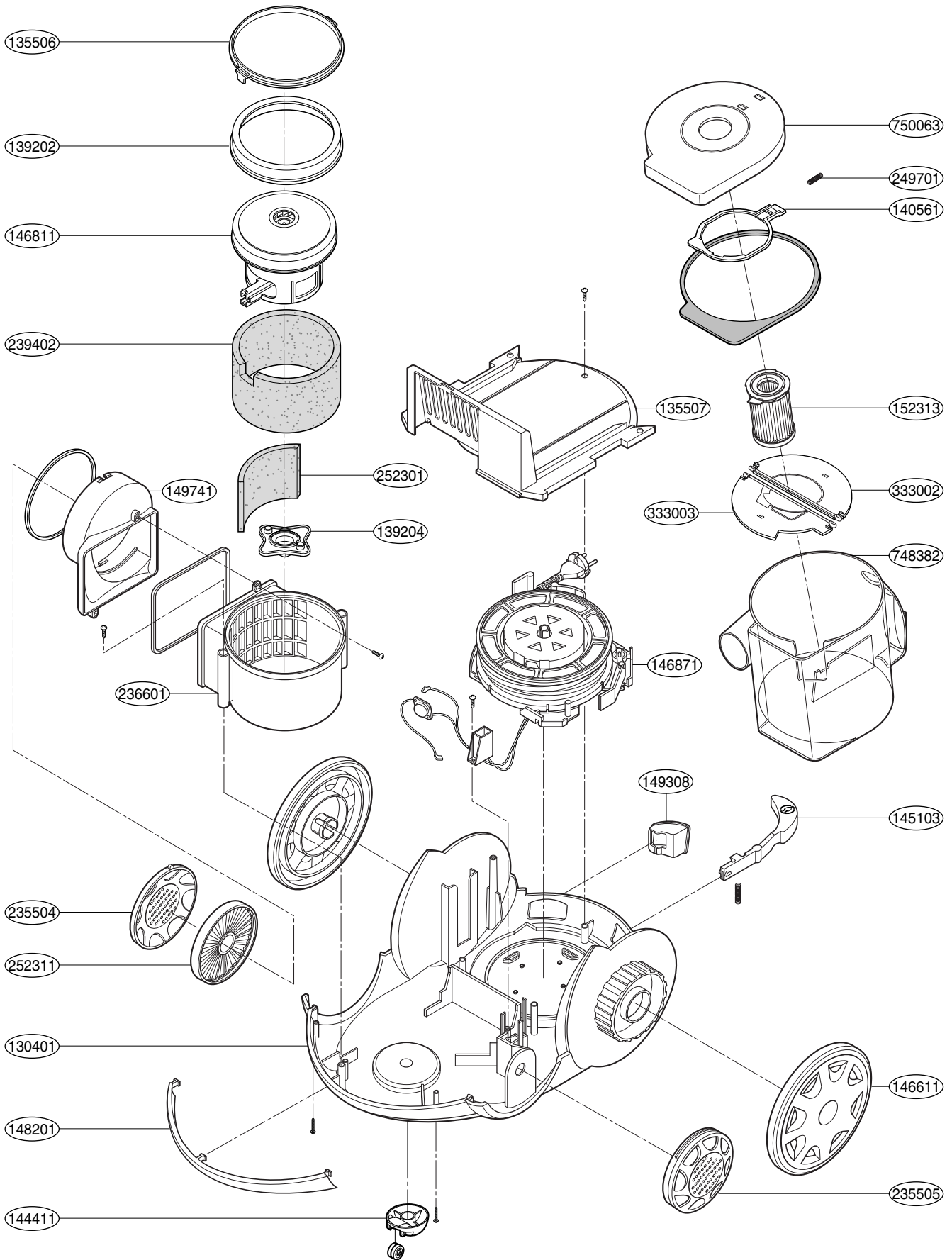

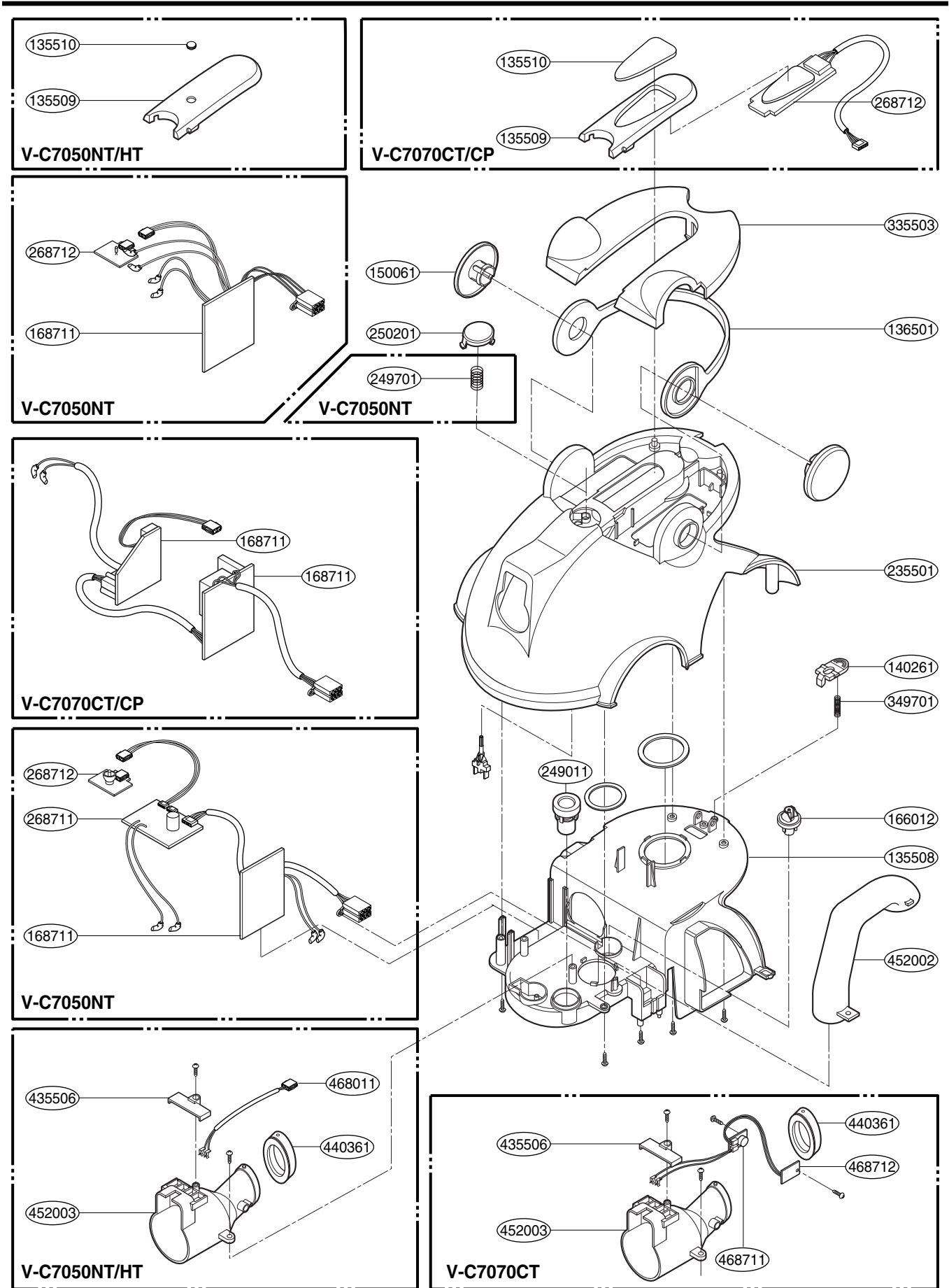

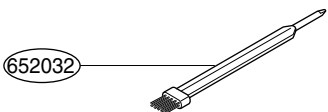
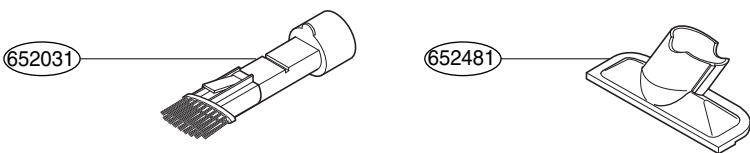
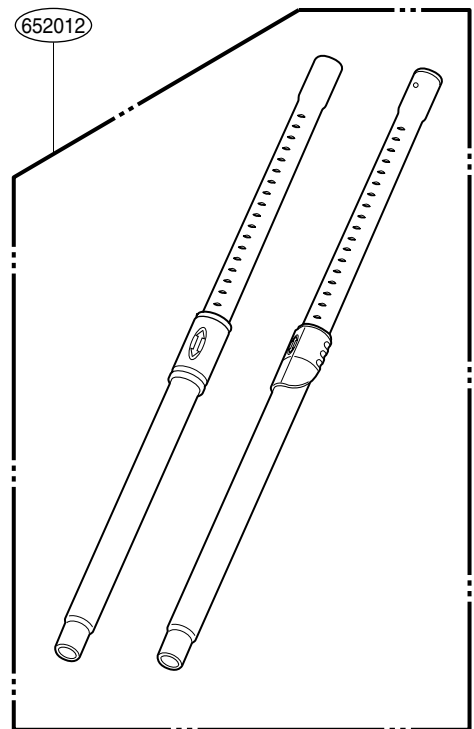
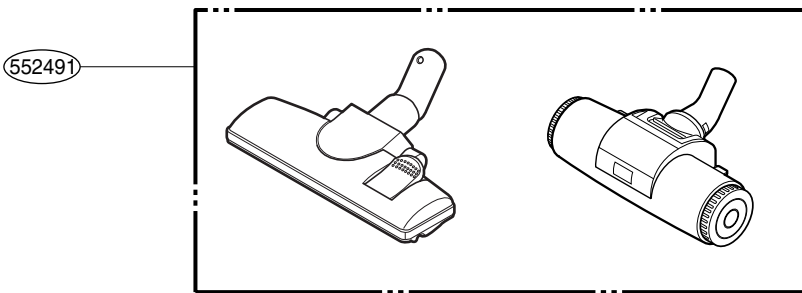
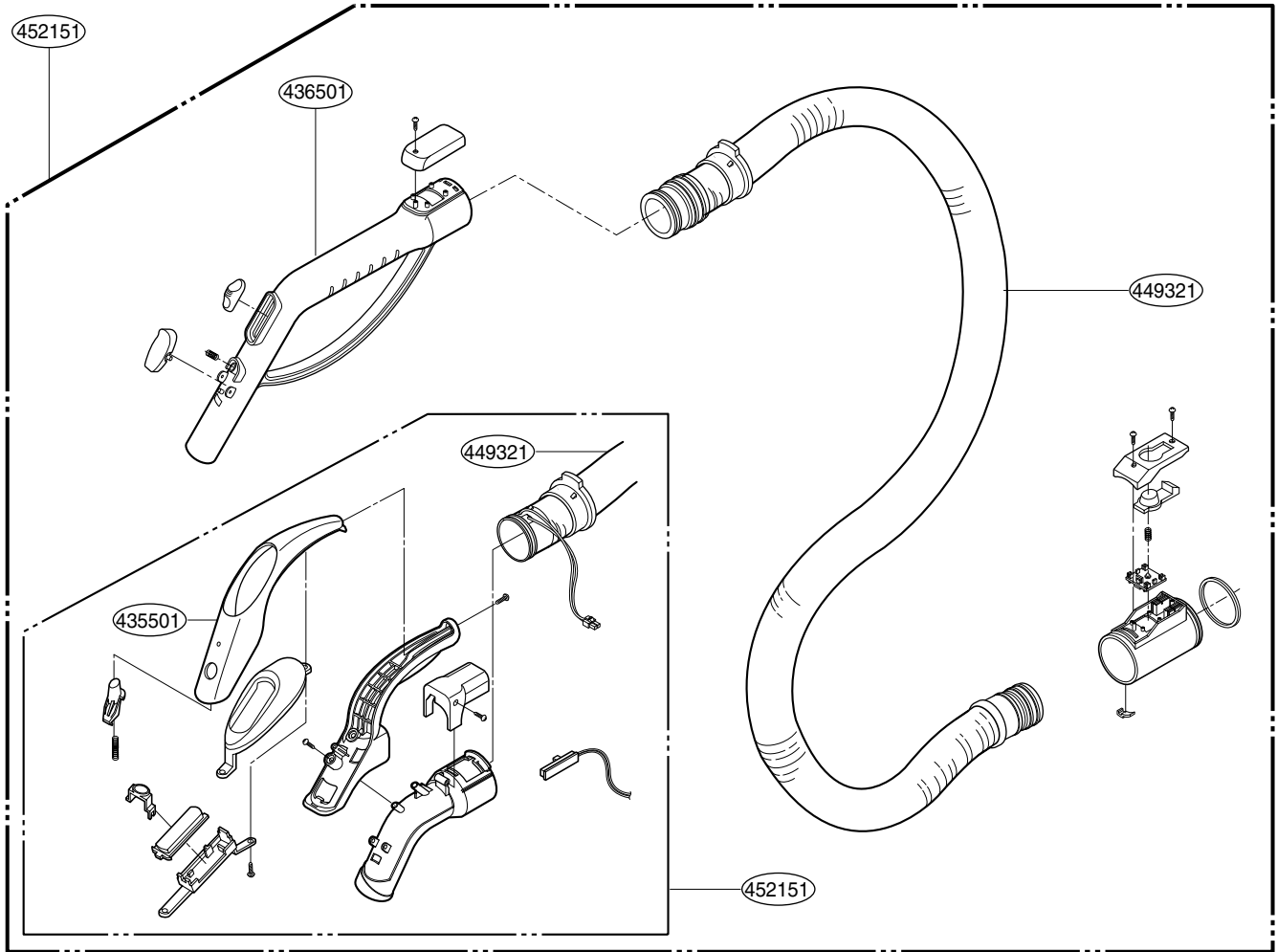

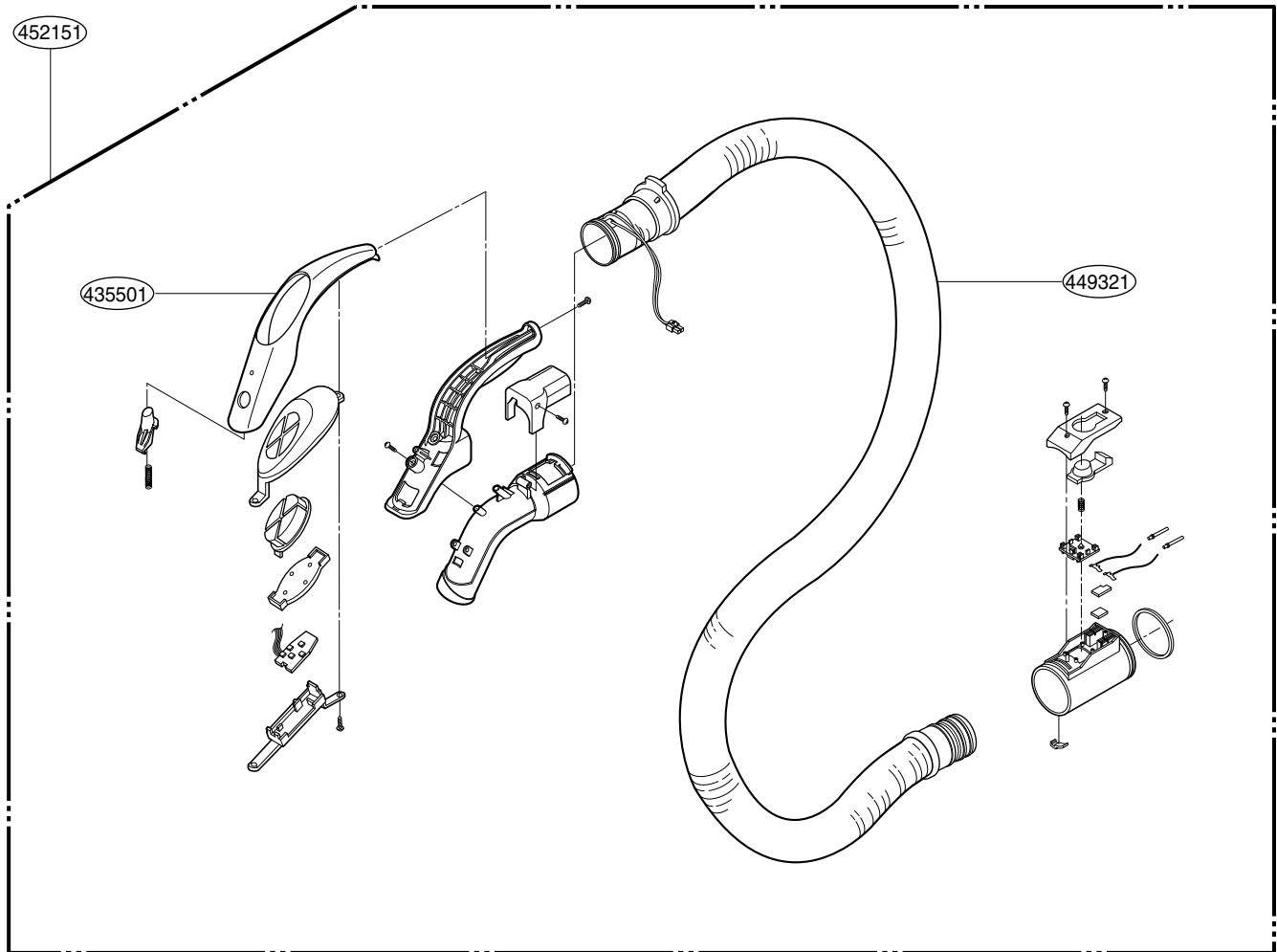

REPLACEMENT PARTS LIST

LOCATION NO.	PART NO.	DESCRIPTION	APPLICATION	REMARK
130401	Refer to appendix	BASE, BODY		
135506	3550FI3800A	COVER, MOTOR HOUSING		
135507	Refer to appendix	COVER, CORD REEL		
135508	Refer to appendix	COVER, BODY SUB		
135509	Refer to appendix	BOARD, DISPLAY		
135510	3550FI3805A	COVER, SENSOR		V-C7050NT/HT
	3550FI2513A			V-C7070CT/CP
136501	Refer to appendix	HANDLE, CARRIER		
139202	3920FI3770A	PACKING, MOTOR MOUNTING		
139204	3920FI3769A	PACKING, SEAL		
140261	Refer to appendix	LATCH, COVER		
140561	Refer to appendix	LOCKER, DUST CAP		
144411	4441FI3605J	CASTER, ASS'Y		
145103	Refer to appendix	LEVER, CORD WINDING		
146611	Refer to appendix	WHEEL, ASS'Y		
146811	Refer to appendix	MOTOR ASS'Y, VC		
146871	4687FI1420X	CORD REEL ASS'Y		
148201	4820FI2391A	BUMPER, BODY		
149308	Refer to appendix	HOLDER, PLUG		
149741	4974FI2396A	GUIDE, EXHAUST		
150061	5006FI3691A	CAP, HANDLE		
152313	5231FI3768A	FILTER ASS'Y, CLEAN		
166012	6601FI3488A	SWITCH ASS'Y, PRESSURE		
168711	Refer to appendix	PWB(PCB) ASS'Y, MAIN		
168711	Refer to appendix	PWB(PCB) ASS'Y, MAIN		
268711	Refer to appendix	PWB(PCB) ASS'Y, SUB		
235501	Refer to appendix	COVER, BODY		
235504	3550FI2504B	COVER, EXHAUST FILTER-R		
235505	3550FI2503B	COVER, EXHAUST FILTER-L		
236601	3660FI2286A	HOUSING(MECH), MOTOR		
239402	3940FI3646A	SPONGE, ABSORBING		

LOCATION NO.	PART NO.	DESCRIPTION	APPLICATION	REMARK
249011	4901FI3435B	DAMPER, ASS'Y		
249701	4970FI4724A	SPRING, BUTTON		V-C7050NT
250201	Refer to appendix	BUTTON, POWER SWITCH		
252301	5231FI3758C	FILTER ASS'Y, CLEAN		
252311	5231FI3767A	FILTER ASS'Y, EXHAUST		
268712	6871FX3078A	PWB(PCB) ASS'Y, DISPLAY		V-C7050NT/HT
	6871XF3080A			V-C7070CT/CP
333002	Refer to appendix	PLATE, COVER(L)		
333003	Refer to appendix	PLATE, COVER(R)		
335503	Refer to appendix	COVER ACCESSARY		
349701	Refer to appendix	SPRING, LATCH		
435501	3550FI1553A	COVER, GRIP HANDLE		
435506	3550FI3802A	COVER, TERMINAL		
436501	3650FI1485C	HANDLE, GRIP		
440361	4036FI3603A	SEAL, PIPE		
449321	4932FI2364D	CONNECTOR(MECH), HOSE ASM		V-C7050NT/HT
	4932FI2723A			V-C7070CT/CP
452002	5200FI2480A	PIPE, CONNECTOR		
452003	Refer to appendix	PIPE, CONNECTOR-H		
452151	5215FI1315E	HOSE ASS'Y, FLEXIBLE		
468711	6871FX3077A	PWB ASS'Y SENSOR		V-C7070CT/CP
468712	6871FX3077B	PWB ASS'Y SENSOR		V-C7070CT/CP
552491	5249FI1399C	NOZZLE ASS'Y, FLOOR		
652012	Refer to appendix	PIPE ASS'Y, TELESCOPIC		
652031	5203FI2069A	BRUSH ASS'Y, DUST		
652032	5203FI3744A	BRUSH ASS'Y, FILTER-CLEANER		
652481	5248FI3454A	NOZZLE, UPHOLSTERY		
748382	Refer to appendix	TANK, DUST		
750063	Refer to appendix	CAP, DUST		

APPENDIX

1. THE TYPE OF POWER CORD & PARTS NUMBER

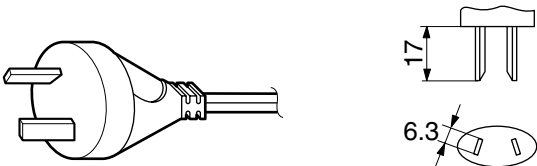
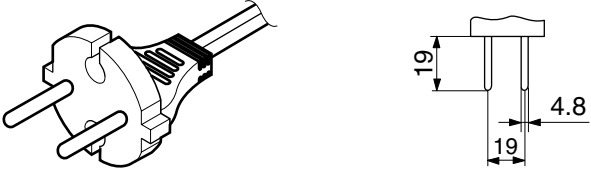
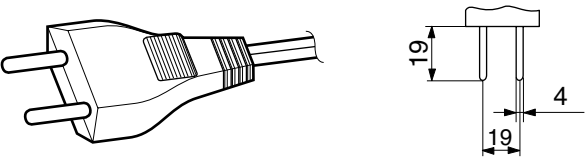
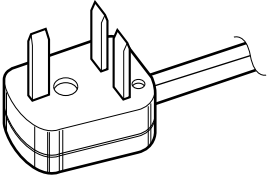
TYPE	TYPE OF PLUG	CORD REEL ASSY P/NO.(L/NO.146871)								
A-1										
S-1										
C-2		4687FI1420X								
C-1										
B-3	 <table border="1" data-bbox="651 1427 878 1630"> <thead> <tr> <th colspan="2">Color identification of fuse</th> </tr> </thead> <tbody> <tr> <td>Brown</td> <td>13A</td> </tr> <tr> <td>Yellow</td> <td>5A</td> </tr> <tr> <td>Blue</td> <td>3A</td> </tr> </tbody> </table>	Color identification of fuse		Brown	13A	Yellow	5A	Blue	3A	
Color identification of fuse										
Brown	13A									
Yellow	5A									
Blue	3A									

2. COLOR & PARTS NUMBER

LOCATION NO.	DESCRIPTION	LIGHT SILVER	NOBLE DEEP BLUE	NOBLE RED	YELLOW GREEN	DEEP BLACK	REMARK
130401	BASE BODY	3040FI1487B	3040FI1487B	3040FI1487E			
135507	COVER, CORD REEL	3550FI1558B	3550FI1558B	3550FI1558E			
135508	COVER, BODY SUB	3550FI1561B	3550FI1561B	3550FI1561E			
135509	BOARD, DISPLAY	3500FI2240B	3500F22240B	3500F22243E			
136501	HANDLE, CARRIER	3650FI1486B	3650FI1486B				V-C7050NT/HT
		3651FI1309A		3651FI1309C			V-C7070CT/CP
140261	LATCH, COVER	4026FI3669B	4026FI3669A	4026FI3669D			
140561	LOCKER, DUST CAP	4056FI3648D	4056FI3648D	4056FI3648D			
145103	LEVER, CORD WINDING	4510FI3598B	4510FI3598B	4510FI3598E			
146611	WHEEL, ASS'Y	4661FI3613B	4661FI3613B	4661FI3613E			
148201	BUMPER, BODY	4820FI2391B	4820FI2391B	4820FI2391E			
149308	HOLDER, PLUG	4930FI2448B	4930FI2448B	4930FI2448E			
235501	COVER, BODY	3550FI1560B	3550F21560B	3550FI1560F			
250201	BUTTON, POWER SWITCH	5020FI3771B	5020FI3771A	5020FI3771D			
333002	PLATE, COVER(L)	3300FI3683B	3300FI3683B	3300FI3683E			
333003	PLATE, COVER(R)	3300FI3684B	3300FI3684B	3300FI3684E			
335503	COVER, ACCESSARY	3550FI1559B	3550FI1559B	3550FI1559D			
435501	COVER, GRIP HANDLE	3550FI1553Q		3550FI1553Y			V-C7070CT/CP
452003	PIPE, CONNECTOR-H	5200FI1215B	5200FI1215B	5200FI1215K			
452151	HOSE ASS'Y, FLEXIBLE	5215FI1319D		5215FI1319E			V-C7070CT
		5215FI1315E	5215FI1315E				V-C7050NT
		5215FI1320B	5215FI1320C	5215FI1320K			V-C7050HT
652012	PIPE ASS'Y TELESCOPIC	5201FI1004A		5201FI2446D			
		5210FI2446D					
748382	TANK, DUST	4838FI1397B	4838F21397B	4838FI1397D			
750063	CAP, DUST	5006FI1327B	5006F21327B	5006FI1327E			

3. MOTOR & PWB ASS'Y PARTS NUMBER

LOCATION NO.	DESCRIPTION	PART NO.	REMARK
146811	MOTOR ASS'Y, VC	4681FI2451A	VMC400E5, 230V/50Hz V-C7030NT
		4681FI12457A	VMC420E5, 230V/50Hz V-C7040TN/C7045HT
		4681FI2456B	VMC460E5, 220~230V/50Hz V-C7050NT/HT
		4681FI2456D	VMC460E8, 220~230V/50Hz V-C7070CT/CP
		4681FI2456E	VMC460E9, 240V/50Hz V-C7070CT/CP
			240V/50Hz
			110V/60Hz
	120V/60Hz		

LOCATION NO.	DESCRIPTION	PART NO.	REMARK
168711	PWB(PCB) ASS'Y, MAIN	6871FX2136A	V-C7050NT
168711	PWB(PCB) ASS'Y, MAIN	6871FX2141A	V-C7050HT/V-C7070CT
268711	PWB(PCB) ASS'Y, SUB	6871FX2142A	V-C7050HT
		6871FX2145A	V-C7070CT

MEMO

MEMO



P/No. : 3828FI3816A

December, 2001
Printed in Korea

Free Manuals Download Website

<http://myh66.com>

<http://usermanuals.us>

<http://www.somanuals.com>

<http://www.4manuals.cc>

<http://www.manual-lib.com>

<http://www.404manual.com>

<http://www.luxmanual.com>

<http://aubethermostatmanual.com>

Golf course search by state

<http://golfingnear.com>

Email search by domain

<http://emailbydomain.com>

Auto manuals search

<http://auto.somanuals.com>

TV manuals search

<http://tv.somanuals.com>