



Service Manual

X4500 Scanner

4036-304

- ***Table of Contents***
- ***Problem Solving***
- ***Safety and Notices***
- ***Trademarks***
- ***Index***

LEXMARK[™]

Lexmark and Lexmark with diamond design are trademarks of Lexmark International, Inc., registered in the United States and/or other countries.

Edition: May 2004

The following paragraph does not apply to any country where such provisions are inconsistent with local law:

LEXMARK INTERNATIONAL, INC. PROVIDES THIS PUBLICATION "AS IS" WITHOUT WARRANTY OF ANY KIND, EITHER EXPRESS OR IMPLIED, INCLUDING, BUT NOT LIMITED TO, THE IMPLIED WARRANTIES OF MERCHANTABILITY OR FITNESS FOR A PARTICULAR PURPOSE. Some states do not allow disclaimer of express or implied warranties in certain transactions; therefore, this statement may not apply to you.

This publication could include technical inaccuracies or typographical errors. Changes are periodically made to the information herein; these changes will be incorporated in later editions. Improvements or changes in the products or the programs described may be made at any time.

Comments may be addressed to Lexmark International, Inc., Department D22A/032-2, 740 West New Circle Road, Lexington, Kentucky 40550, U.S.A or e-mail at ServiceInfoAndTraining@Lexmark.com. Lexmark may use or distribute any of the information you supply in any way it believes appropriate without incurring any obligation to you. You can purchase additional copies of publications related to this product by calling 1-800-553-9727. In other countries, contact your point of purchase.

Lexmark and Lexmark with diamond design are trademarks of Lexmark International, Inc., registered in the United States and/or other countries.

Other trademarks are the property of their respective owners.

**© Copyright Lexmark International, Inc. 2002, 2004.
All rights reserved.**

UNITED STATES GOVERNMENT RESTRICTED RIGHTS

This software and documentation are provided with RESTRICTED RIGHTS. Use, duplication or disclosure by the Government is subject to restrictions as set forth in subparagraph (c)(1)(ii) of the Rights in Technical Data and Computer Software clause at DFARS 252.227-7013 and in applicable FAR provisions: Lexmark International, Inc., Lexington, KY 40550. U.S.A.

P/N 12G9084

Table of Contents

Safety Information	V
Safety Information	v
Overview	1-1
Service Guidelines	1-1
Product Description	1-1
Product Features	1-1
Ease of Use	1-1
Digital Copier and Full-function Fax Machine	1-2
Network Scanning	1-2
Duplex Scanning through the Auto Document Feeder (ADF)	1-2
Product Specifications	1-3
Theory of Operation	1-5
System Description	1-5
Mechanical Operation	1-5
Scanner Mechanism Overview and Locations	1-7
External View	1-7
Internal Components	1-8
Abbreviations	1-9
Problem Solving	2-1
Error Codes	2-1
MFD Controller Errors	2-1
Scanner Errors	2-4
Troubleshooting	2-6
Maintenance	3-1
Cleaning	3-1
Cover and Glass	3-1
Touch Screen	3-1
ADF Unit	3-1
Maintenance Tools	3-2
Removals	3-2
Parts Replacement	3-2
ADF Snap-in Pad Module Removal and Mounting	3-4
Document Cover Removal	3-5
ADF Cover Removal	3-5
ADF Optical CCD Unit Removal	3-6
ADF Unit (Upper and Lower Unit) Removal	3-7
User Interface Removal	3-9
Upper Housing Removal	3-12
Flatbed CCD Optical Unit Removal	3-14
Carriage Motor Assembly Removal	3-16
Carriage Belt Pulley Assembly Removal	3-16
MFD Controller Cage Removal	3-16

Hard Disk Drive, MFD Controller Card, 1394 Communications Card and Power Distribution Board Removal	3-19
Main Control Board Removal	3-21
Connector Locations	4-1
Main Scanner Board	4-1
MFD Controller Cage	4-2
Low Voltage Power Supply	4-2
Parts Catalog	5-1
Index	I-1

Safety Information

Safety Information

- This product is designed, tested and approved to meet strict global safety standards with the use of specific Lexmark components. The safety features of some parts may not always be obvious. Lexmark is not responsible for the use of other replacement parts.
- The maintenance information for this product has been prepared for use by a professional service person and is not intended to be used by others.
- There may be an increased risk of electric shock and personal injury during disassembly and servicing of this product. Professional service personnel should understand this and take necessary precautions.

Consignes de Sécurité

- Ce produit a été conçu, testé et approuvé pour respecter les normes strictes de sécurité globale lors de l'utilisation de composants Lexmark spécifiques. Les caractéristiques de sécurité de certains éléments ne sont pas toujours évidentes. Lexmark ne peut être tenu responsable de l'utilisation d'autres pièces de rechange.
- Les consignes d'entretien et de réparation de ce produit s'adressent uniquement à un personnel de maintenance qualifié.
- Le démontage et l'entretien de ce produit pouvant présenter certains risques électriques, le personnel d'entretien qualifié devra prendre toutes les précautions nécessaires.

Norme di sicurezza

- Il prodotto è stato progettato, testato e approvato in conformità a severi standard di sicurezza e per l'utilizzo con componenti Lexmark specifici. Le caratteristiche di sicurezza di alcune parti non sempre sono di immediata comprensione. Lexmark non è responsabile per l'utilizzo di parti di ricambio di altri produttori.
- Le informazioni riguardanti la manutenzione di questo prodotto sono indirizzate soltanto al personale di assistenza autorizzato.
- Durante lo smontaggio e la manutenzione di questo prodotto, il rischio di subire scosse elettriche e danni alla persona è più elevato. Il personale di assistenza autorizzato, deve, quindi, adottare le precauzioni necessarie.

Sicherheitshinweise

- Dieses Produkt und die zugehörigen Komponenten wurden entworfen und getestet, um beim Einsatz die weltweit gültigen Sicherheitsanforderungen zu erfüllen. Die sicherheitsrelevanten Funktionen der Bauteile und Optionen sind nicht immer offensichtlich. Sofern Teile eingesetzt werden, die nicht von Lexmark sind, wird von Lexmark keinerlei Verantwortung oder Haftung für dieses Produkt übernommen.
- Die Wartungsinformationen für dieses Produkt sind ausschließlich für die Verwendung durch einen Wartungsfachmann bestimmt.
- Während des Auseinandernehmens und der Wartung des Geräts besteht ein zusätzliches Risiko eines elektrischen Schlags und körperlicher Verletzung. Das zuständige Fachpersonal sollte entsprechende Vorsichtsmaßnahmen treffen.

Pautas de Seguridad

- Este producto se ha diseñado, verificado y aprobado para cumplir los más estrictos estándares de seguridad global usando los componentes específicos de Lexmark. Puede que las características de seguridad de algunas piezas no sean siempre evidentes. Lexmark no se hace responsable del uso de otras piezas de recambio.
- La información sobre el mantenimiento de este producto está dirigida exclusivamente al personal cualificado de mantenimiento.
- Existe mayor riesgo de descarga eléctrica y de daños personales durante el desmontaje y la reparación de la máquina. El personal cualificado debe ser consciente de este peligro y tomar las precauciones necesarias.

Informações de Segurança

- Este produto foi concebido, testado e aprovado para satisfazer os padrões globais de segurança na utilização de componentes específicos da Lexmark. As funções de segurança de alguns dos componentes podem não ser sempre óbvias. A Lexmark não é responsável pela utilização de outros componentes de substituição.
- As informações de segurança relativas a este produto destinam-se a profissionais destes serviços e não devem ser utilizadas por outras pessoas.
- Risco de choques eléctricos e ferimentos graves durante a desmontagem e manutenção deste produto. Os profissionais destes serviços devem estar avisados deste facto e tomar os cuidados necessários.

Informació de Seguretat

- Aquest producte està dissenyat, comprovat i aprovat per tal d'acomplir les estrictes normes de seguretat globals amb la utilització de components específics de Lexmark. Les característiques de seguretat d'algunes peces pot ser que no sempre siguin òbvies. Lexmark no es responsabilitza de l'us d'altres peces de recanvi.
- La informació pel manteniment d'aquest producte està orientada exclusivament a professionals i no està destinada a ningú que no ho sigui.
- El risc de xoc elèctric i de danys personals pot augmentar durant el procés de desmuntatge i de servei d'aquest producte. El personal professional ha d'estar-ne assabentat i prendre les mesures convenients.

안전 사항

- 본 제품에 관한 유지 보수 설명서는 전문 서비스 기술자 용으로 작성된 것이므로 비 전문가는 사용할 수 없습니다.
- 본제품을 해체하거나 정비할 경우 전기적인 충격을 받거나 상처를 입을 위험이 커집니다. 전문 서비스 기술자는 이 사실을 숙지하고 필요한 예방 조치를 취하도록 하십시오.
- 일부 부품의 안전성은 항상 보장되지 않습니다. 따라서, 교체 부품은 원래 부품과 같거나 동등한 특성을 가진 제품을 사용하여야 합니다.

安全资讯

- 本产品的维护资讯仅供专业服务人员使用，而非针对一般使用者。
- 本产品在拆卸、维修的时候，遭受电击或人员受伤的危险性会增高，专业服务人员对这点必须有所了解，并采取必要的预防措施。
- 有些零件的安全功能可能不明显。因此，所替换零件的性能一定要与原有的零件一致。

1. Overview

This manual is for maintenance engineers. It describes the maintenance areas, installation, disassembly, and the main troubleshooting guides.

Take your time to read this manual thoroughly to obtain comprehensive knowledge about the scanner before servicing the unit.

Service Guidelines

1. Before disassembling the scanner, make sure the power supply cord is disconnected from the power outlet. Do not remove or install the connectors on the scanner with the power supply turned ON.
2. Use caution not to drop small parts or screws inside the unit when disassembling and reassembling.
3. Do not pull the connector cable when disconnecting it. Hold the connector.
4. When carrying the scanning head unit, put it in an anti-static bag.
5. Keep the document glass platen surface clean with a dry clean lint free cloth.

Product Description

The 4036-304 Scanner is a multifunction solution that offers integrated print, copy, fax and color network-scanning capabilities for increased small workgroup productivity. The scanner is easy to use and provides low-cost access to key office functions, including fax from workstation, network color copying, scanning, and electronic document routing.

Give your document to the scanner, and in a few steps, it scans to the network and delivers it wherever, to whomever you want. With this scanner, inefficient trips to the mailroom, copier, fax machine and to your workstation are a thing of the past.

Product Features

Ease of Use

The user interface on the front of the scanner looks like a panel on a copier with standard phone keys added. The operating steps follow the same procedure as that of a copier or fax machine.

Digital Copier and Full-function Fax Machine

When the scanner is connected to a Lexmark printer, it performs convenient digital copying. When connected to telephone line, the scanner performs a full fax function - to send and to receive faxes.

Network Scanning

The scanner uses two Color Charge-Coupled Devices (CCD) when scanning. Through a network port at the rear of the scanner, the product is able to do network scanning.

Duplex Scanning through the Auto Document Feeder (ADF)

To increase workgroup productivity, the scanner uses the advance duplex scanning capability. The scan speed limit is 20 ppm at 300 dpi resolution. The auto document feeder can hold up to 50 pages at one time.

4036-304

Environment: -Operating -Storage	10°C to 35°C (50°F to 95°F) 20% to 80% RH (Relative Humidity) -40°C to 65°C (-40°F to 149°F) 10% to 90% RH (Relative Humidity)
Random Vibration: -Unpacked non-op -Package -Bump -Drop	10-200Hz, 0.005 p.s.d. (G ² /Hz) 5-200Hz, 0.015 p.s.d. -6 dB/oct One hour in 3 major axes Severity: 25g/6ms, 1000 times in each direction Must meet NSTA specification Drop Point: 1 corner, 3 edges and 6 surfaces Total 10 times
Acoustic Noise	Operating: 58 dB or less
Electrostatic Discharge	EC 1000-4-2 ESD Standard
Safety Regulation	UL, CSA, TUV/GS, SEMKO
EMC regulation	FCC Part 15 Subchapter J Class A CE Marking, C-Tick
ADF	
General Specifications: -Optical Resolution -Document Capacity	300x300 dpi 50 sheets
Document: -Document Size -Thickness	Max. 8.5 x 14 inch (W x L) Min. 4.5 x 5.5 inch (W x L) 0.05~0.15 mm

Theory of Operation

System Description

The Lexmark X4500 is a duplexing scanner option which can synchronously scan both the top and bottom sides of a document in color. The major system components include a main scanner control board, an automatic document feeder, flatbed, two optical CCD modules (one in ADF, one in flatbed), a user interface with a touch screen panel and a multifunction device controller cage located within the base of the scanner. The MFD controller cage includes a 1394 communications card to communicate with the main scanner board (for generation 1 controller cards only; for generation 2 controller cards, the 1394 communications circuitry is built into the controller card), a MFD controller board to process all jobs performed on the X4500, a hard disk drive containing the operational code for the system and providing memory for processing jobs, and a power distribution board. An external power supply provides 5, 12, and 24 V dc to the entire scanner system.

The following figure shows the system block diagram.

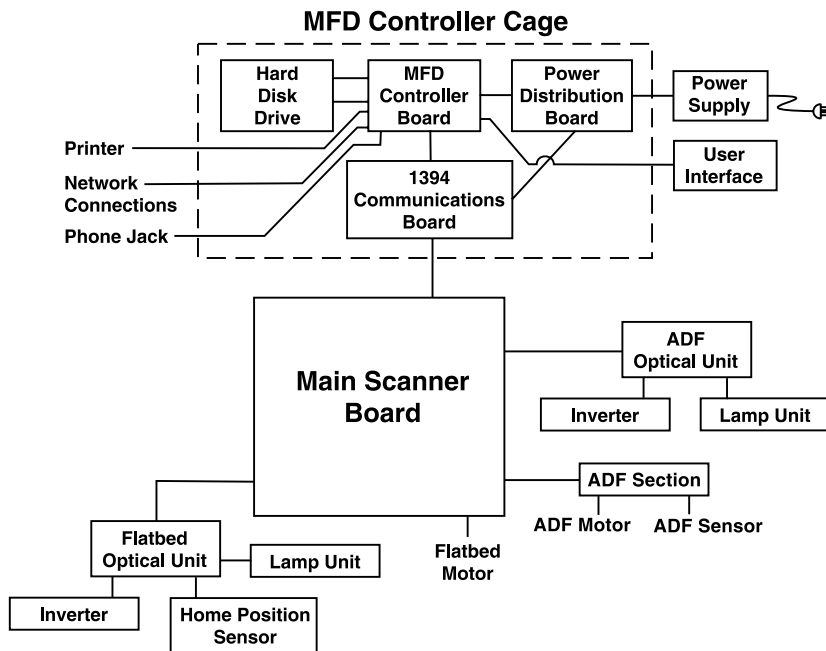

Mechanical Operation

Flatbed Operation

When scanning, place the document on the flatbed glass platen, the flatbed optical unit/carrier moves across the underside of the glass, and scans the document. A charge-coupled device (CCD) mounts to the carrier and optically reads the image from the page. The carrier is driven by a 2-phase stepping motor which moves the carriage at 1/300 inch each step.

Auto Document Feeder Operation

When using the Auto Document Feeder (ADF) mechanism, a page is fed into the ADF by a pick roller and through the ADF by a feed roller. A separation pad located opposite to the pick roller is used to properly feed the pages one at a time when placed on the input tray. The flatbed optical unit/carrier is positioned to the far left so when the paper passes through the ADF, the bottom side of the page is scanned by the flatbed CCD. The home position sensor detects when the carrier is in the proper position for ADF scanning. In addition, an ADF cover open sensor detects when the upper ADF assembly is open or closed into proper operating position. The scanner cannot operate when this sensor is open.

While the page is fed through and scanned from the bottom via the flatbed CCD, the top side of the page is simultaneously scanned via a CCD unit positioned within the ADF unit. As the page feeds between the two CCD units, the page discharges to the exit tray on the left side of the ADF.

Scanner Mechanism Overview and Locations

This section contains an overview of the major components of the scanner hardware.

External View

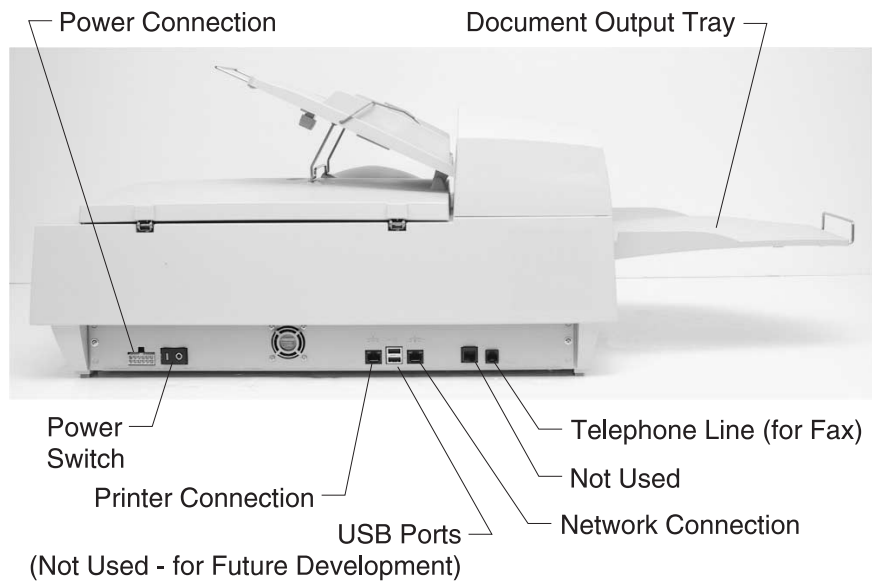
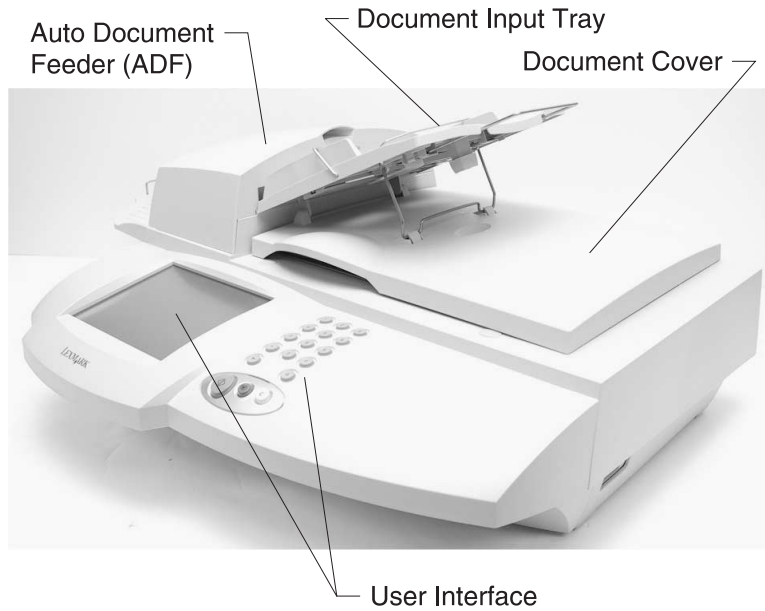

Internal Components

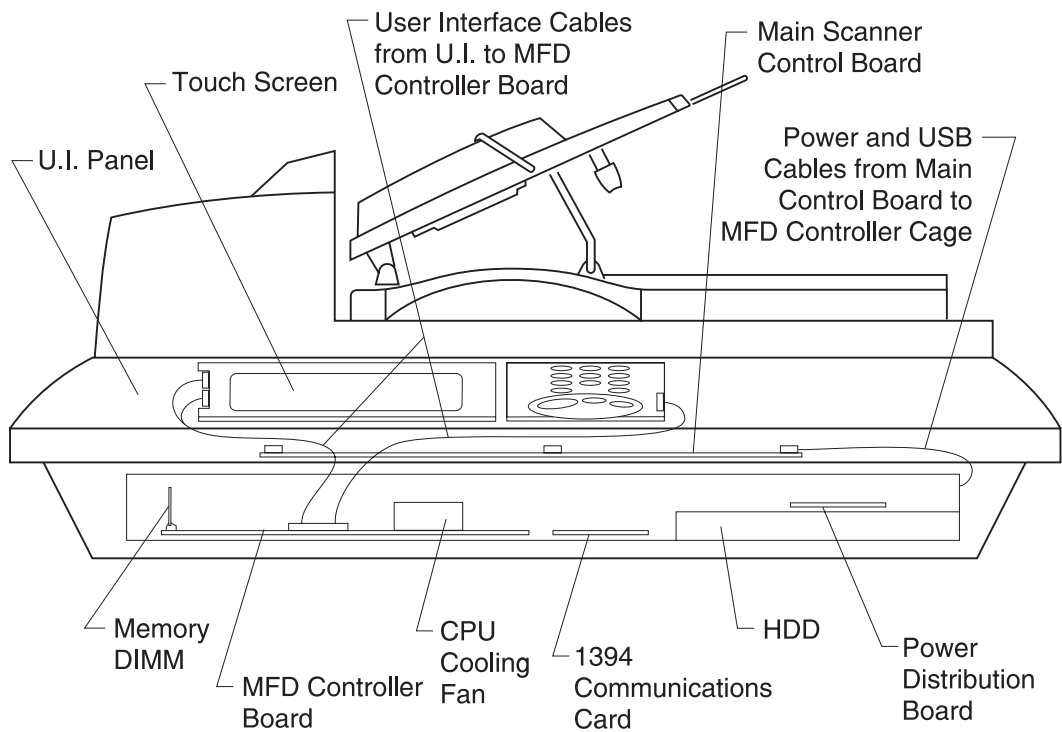
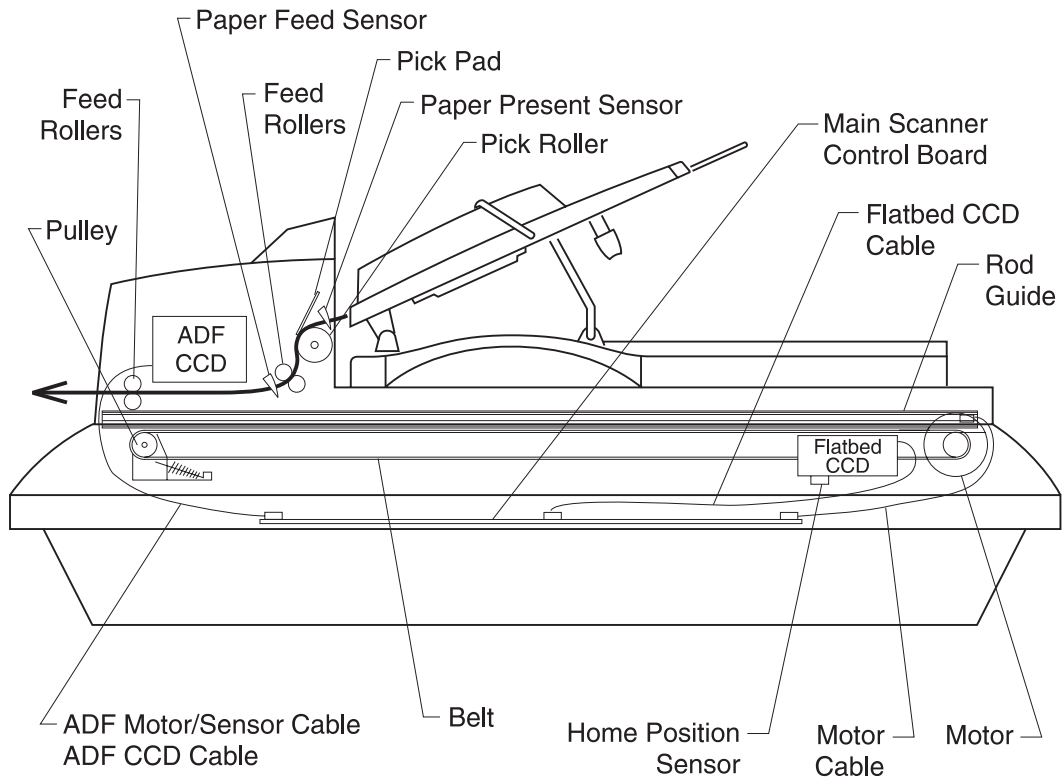

Abbreviations

ADF	Auto Document Feeder
CCD	Charge-Couple Device
CCFL	Cold Cathode Fluorescent Lamp
CDB	Command Descriptor Blocks
DMM	Digital Multimeter
LED	Light Emitting Diode
MFD	Multi Function Device
PCBA	Printed Circuit Board Assembly
UI	User Interface

2. Problem Solving

This chapter describes two methods to solve the operational problems. The first relies on the scanner internal diagnostics to report error codes. The second uses troubleshooting techniques to isolate the problem. In many cases, the internal error codes will help you to locate the source of the problem quickly. If no error codes are reported, or if the error codes do not locate the source of the problem, refer to the troubleshooting section.

Error Codes

MFD Controller Errors

MFD Controller Errors are errors detected by the MFD controller card within the MFD cage pertaining to electronic cards. All MFD controller cage errors are posted to the user interface touch screen along with audible beep codes and LED codes. During the Power-On Self Test procedure, errors detected cause a number of audible beeps to be produced three times. The corresponding LED pattern continuously displays on the controller card until the system is powered down. Use the following tables to read the beep/LED codes and follow the recommended repair action.

Note: For generation 1 MFD controller cards, there are two rows of four LEDs. The LEDs are difficult to view as the controller cage must be removed from the scanner. The LED pattern shown depicts which LEDs are illuminated in the two rows.



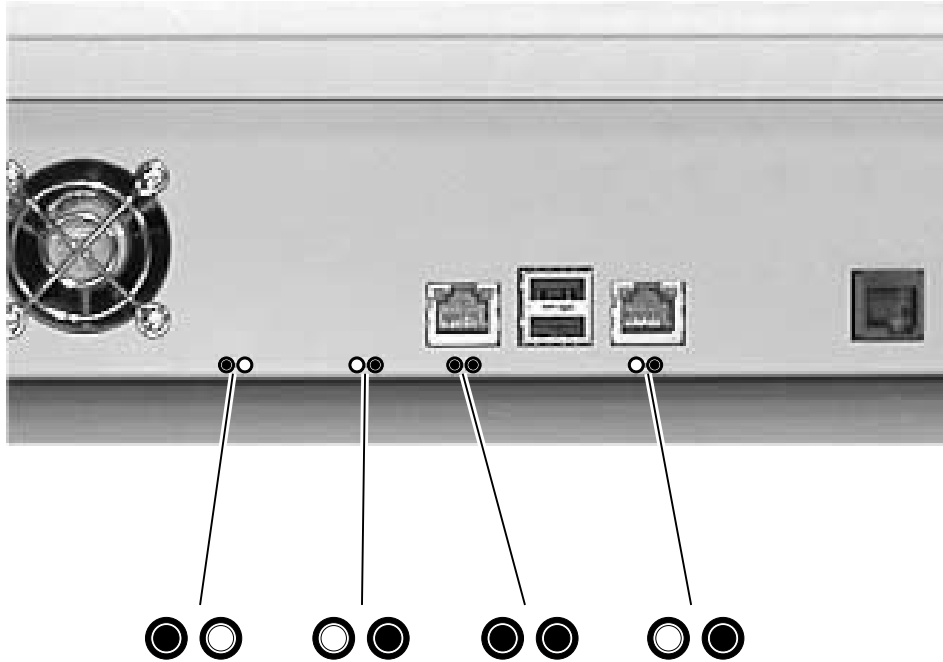

Generation 1
Controller

Note: For generation 2 MFD controller cards, there are four pairs of LEDs. The LEDs are viewable after the controller cage is removed from the scanner. The LED pattern shown depicts which LEDs are illuminated in the two rows.

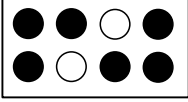

Error number and description	Number of beeps	MFD controller card generation	LED pattern (on= ☉ , off= ●)	Action
Error: 21 - Modem not found	2	1st		Modem on the MFD controller card is not found. Replace the MFD controller card.
		2nd		
Error: 22 - PCI Bus failure	2	1st		Replace the MFD controller card.
		2nd		
Error: 23 - Internal scanner card failure		2		The 1394 communication protocol on the MFD controller card has failed. Replace the MFD controller card.

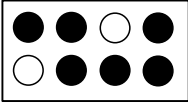
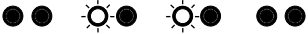
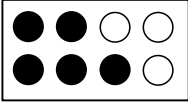
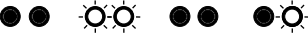
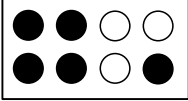
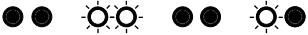
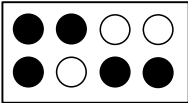
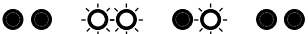
Error number and description	Number of beeps	MFD controller card generation	LED pattern (on= ☉ , off= ●)	Action
Error: 24 - Serial port failure	2	1st		Problem with TTY/Serial Port. Replace the MFD controller card.
		2nd		
Error: 28 - Problem with the CPU	2	1st		Replace the MFD controller card.
		2nd		
Error: 31 - No hard drive found. Note: Error message not displayed. Only beep code and LED patterns are generated for error 31.	3	1st		Check connections to the hard disk drive and associated cables for continuity. Check power going to the hard disk drive. Replace the power distribution card if no power is present. If power is present, replace the hard disk drive.
		2nd		
Error: 32 - Corrupt hard disk drive Note: Error message not displayed. Only beep code and LED patterns are generated for error 32.	3	1st		Replace or reformat the hard disk drive. See “Hard disk drive refresh” on page 3-1.
		2nd		
Error: 34 - Hard Drive failure	3	1st		There was an error writing to the hard disk drive. Replace or reformat the hard disk drive. See “Hard disk drive refresh” on page 3-1.
		2nd		

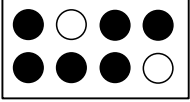
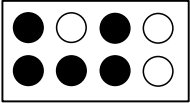
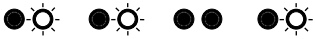
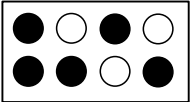
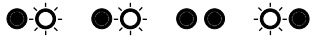
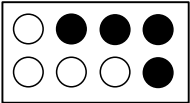
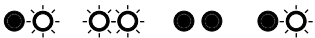
Error number and description	Number of beeps	MFD controller card generation	LED pattern (on= ☉ , off= ●)	Action
Error: 41 - Scanner interface not found	4	1st		The scanner image processor board was not found. Check connections to the interface board. If connections are good, replace the image processor board.
		2nd	N/A	
Error: 51 - Not enough memory Note: Error message not displayed. Only beep code and LED patterns are generated for error 51.	5	1st		The memory DIMM was not detected or not functioning. Replace the memory DIMM.
		2nd		
Error: 52 - Not enough memory	5	1st		The memory DIMM was found, but not enough memory is present. Replace the memory DIMM.
		2nd		
Error: 71 - User Interface failure	7	1st		A problem was detected with the user interface. Check the connection of all cables connecting the UI to the MFD controller card. If cables are okay, replace the user interface. If problem persists, replace the MFD controller card.
		2nd		

Scanner Errors

Scanner Errors are errors detected within the scanner mechanism and auto document feeder assembly. These errors appear on the user interface touch screen along with a number of flashes of the flatbed CCD lamp (the flash sequence is repeated 10 times). See the following table for an explanation of each error code and the corrective action to resolve the problem.

Number of CCD Lamp Flashes	Error Message Displayed to UI	Action
1	Oasis 1 SDRAM failure	Replace the main scanner board.
2	Oasis 2 SDRAM failure	Replace the main scanner board.
3	CPU SDRAM failure	Replace the main scanner board.
4	Flatbed A/D Dark Calibration Error	Replace the flatbed optical unit assembly. If problem persists, replace the main scanner board.
5	ADF A/D Dark Calibration Error	Replace the ADF optical unit. If problem persists, replace the main scanner board.
6	Home Sensor failure	Check the flatbed motor, belt and home position sensor for proper operation. Replace any defective parts. If no defective parts are found, replace the main scanner board.
7	Flatbed Lamp failure	Check the flatbed optical unit for proper connection. Replace the flatbed optical unit if necessary.
8	ADF Lamp failure	Check the ADF optical unit for proper connection. Replace the ADF optical unit if necessary.
None	SCSI Command Not Supported	Replace the main scanner board.
None	Invalid field in CDB	Replace the main scanner board.

Number of CCD Lamp Flashes	Error Message Displayed to UI	Action
None	Could not match scanner, aborting	The MFD controller cage could not find the rest of the scanner. Make sure the USB-style cable is properly connected between the 1394 communications board and main scanner control board. If problem persists, replace the main scanner board. If problem persists, replace 1394 communications board.

Troubleshooting

The tables in this section provide detailed troubleshooting information.

The Power does not come on

Cause	Relevant Unit	Check *	Action
Unplugged from outlet	None	Visual check	Insert the ac plug into the outlet.
AC power unplugged at power supply	LVPS	Visual check	Insert the ac cable into power supply.
Power switch is OFF	None	Visual check	Turn the power switch on.
Power supply power distribution board connection failure	None	Visual check	Connect the connector.
Power supply output voltage failure	LVPS	Tester check the LVPS (+5V +12V, +24V, GND)	Replace the power supply.
Power distribution board	Power distribution board	Tester check (+5V, GND)	Replace the failed power distribution board.
MFD controller board	MFD controller board	None	If problem still exists, replace MFD controller board.

* Check explains how to check the failed item. To do a visual check observe the part or observe the offline test display on the front panel. To do a tester check, check the voltage levels of the relevant units. (See Connector Locations.)

Scan module does not move to lock position

Cause	Relevant Unit	Check	Action
Home position sensor board failure	CCD board	Tester check	Replace the CCD PCBA.
Motor-main control PCBA connection failure	None	Visual check	Connect the connector.
Motor failure	Carrier motor	Visual check	Replace the carrier motor.
Power supply-main control board connection failure	None	Visual check	Connect the connector.
Power supply fails.	Power supply	Tester check (+24V, GND)	Replace the power supply.

Scan module does not move to the home position

Cause	Relevant Unit	Check	Action
Home position sensor board-main control PCBA connection failure	None	Visual check	Connect the connector.
Home position sensor board failure	Sensor in the flatbed CCD assembly	Tester check	Replace the flatbed CCD optical unit.
Power supply-main control board connection failure	None	Visual check	Connect the connector.
Power supply fails	Power supply	Tester check (+5V, +24V, GND)	Replace the power supply.
Lamp failure	Lamp	Visual check	Replace the flatbed CCD optical unit.
Inverter failure	Inverter	Visual check	Replace the flatbed CCD optical unit.
CCD board-main scanner board connection failure	None	Visual check	Connect the connector.
CCD board fails	CCD board	Tester check	Replace the flatbed CCD optical unit.

Scan module does not move to the flatbed position

Cause	Relevant Unit	Check	Action
Power supply-main scanner board connection failure	None	Visual check	Connect the connector.
Power supply fails	Power supply	Tester check (+5V, +24V, GND)	Replace the power supply.
Motor-main scanner board connection failure	None	Visual check	Connect the connector.
Motor failure	Carrier motor	Visual check	Replace the carrier motor.
Belt broken or loose	Carrier belt	Visual check	Reposition belt or replace if defective.

Reading is not performed

Cause	Relevant Unit	Check	Action
ADF cover open	ADF cover	Visual check	Close the ADF cover.

Image does not appear

Cause	Relevant Unit	Check	Action
ADF cover open	ADF cover	Visual check	Close the ADF cover.
1394 Communication board-main control board connection failure	None	Visual check	Connect the connector.
Lamp Inverter failure	Lamp inverter	Visual check	Replace the CCD optical unit.
CCD board-main scanner board connection failure	None	Visual check	Connect the connector.
CCD board fails	CCD board	Visual check	Replace the optical unit.

Large jitter

Cause	Relevant Unit	Check	Action
1394 Communication - main control board connection failure	None	Visual check	Connect the connector.
Motor-main scanner PCBA connection failure	None	Visual check	Connect the connector.
Motor failure	Carrier motor	Visual check	Replace the carrier motor.

Reading position deviation

Cause	Relevant Unit	Check	Action
Motor-main scanner PCBA connection failure	None	Visual check	Connect the connector.
Motor failure	Carrier motor	Visual check	Replace the carrier motor.
Home position sensor board-main scanner PCBA cable failure	Flatbed CCD optical unit cable	Tester or visual check	Replace the flatbed CCD optical unit cable.
Home position sensor board failure	Flatbed CCD optical unit	Tester check	Replace the flatbed CCD optical unit.

Image unclear

Cause	Relevant Unit	Check	Action
Lamp too dark	Lamp	Visual check	Replace CCD optical unit.
Dirt on calibration reference plate	Calibration reference plate	Visual check	Clean the flatbed glass with isopropyl alcohol.
Dirt on the mirrors	Mirrors	Visual check	Clean the mirrors with isopropyl alcohol.
Dirt on the lens	Lens	Visual check	Clean the lens with isopropyl alcohol.

Strange Sound Generated (flatbed)

Cause	Relevant Unit	Check	Action
Motor unit failure	Motor unit	Visual check	Replace the carrier motor.
Main scanner card failure	Main scanner card	Replace the main scanner card.	Replace the main scanner card.
Scanning module	Scanning module	Check if scanning module is loose.	Replace the flatbed CCD optical unit.
Dirt on rail	None	Visual check	Clean the rail with isopropyl alcohol.

Frequent paper jam, double feed or skew

Cause	Relevant Unit	Check	Action
Paper setting failure	Operation error	Is the paper correctly set in the paper chute?	Teach users to properly position the paper.
Paper failure	Operation error	Is the specified paper used?	None
ADF connector slip-off	ADF unit	Visual check of motor rotation	Connect the connector.
Pad assembly failure	Pad assembly	Check the pad assembly for wear and tear.	Clean/replace the pad assembly/touch spring unit
ADF unit failure	ADF unit	Replace the ADF unit.	Replace the ADF unit.

Strange sound generated (ADF)

Cause	Relevant Unit	Check	Action
Paper setting failure	Operation error	Is the paper correctly set in the paper chute?	Teach users to properly position the paper.
Paper failure	Operation error	Is the specified paper used?	None
ADF connector slip-off	ADF unit	Visual check of motor rotation	Connect the connector.
ADF unit failure	ADF unit	Replace the ADF unit.	Replace the ADF unit.

3. Maintenance

This chapter describes cleaning methods maintenance parts replacement, and adjustment and lubrication necessary for normal scanner operation.

Perform preventative maintenance in the shorter term either every six months or every 60,000 sheets scanning.

Cleaning

Cover and Glass

With soft cloth, wipe the cover and glass. If the dirt is heavy, use a neutral cleanser or alcohol. Wipe the glass carefully so no cleanser remains on the surface.

Touch Screen

Wipe the touch screen with a clean, lint-free cotton cloth dampened with water.

ADF Unit

Push the ADF unit backward to open the unit. Clean the pad assembly and feed roller in the ADF with a lint-free cloth and isopropyl alcohol. Clean the pad assembly by wiping it in the direction of the arrow as shown.

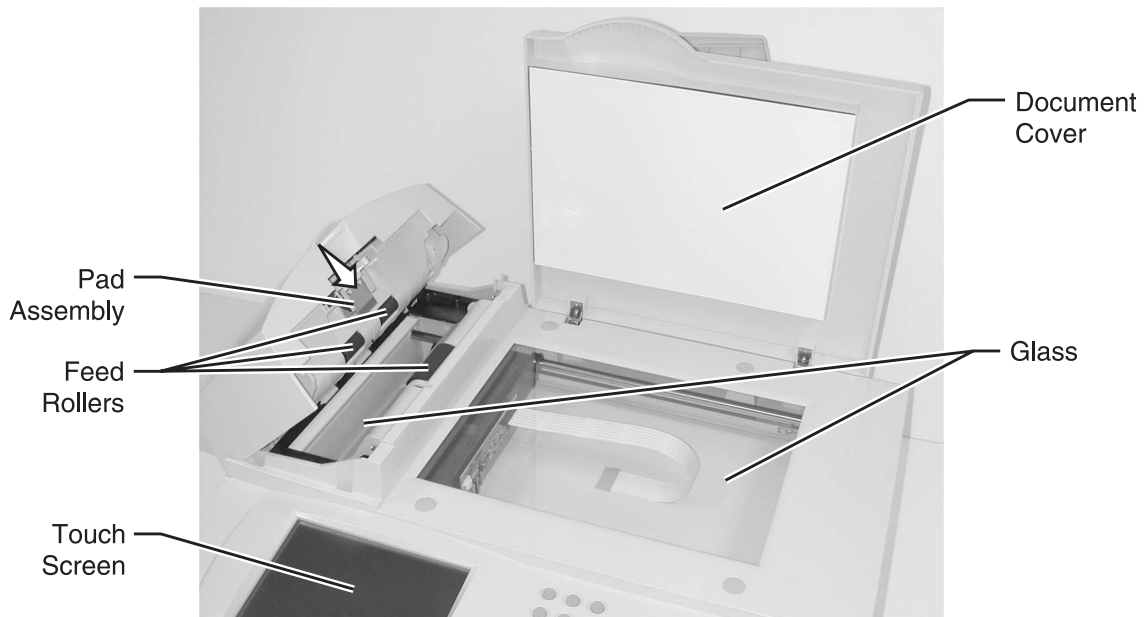

Maintenance Tools

The following table describes the tools necessary for the maintenance of this scanner.

Name	Description
Flathead screwdriver	Idler pulley module screw
Phillips screwdriver (magnetic)	Nominal No.2 M3, M4
Nut driver	6 mm
Digital voltmeter	With 0.01 V range
Chip Puller	Puller for main scanner board chip

Removals

Parts Replacement

1. Clean the disassembly and assembly location.
2. Turn off the power switch and remove the AC plug from the outlet before disassembly and assembly.
3. Follow the disassembly and assembly procedures. Never loosen the screws of parts that must not be disassembled. These screws have a red coating.
4. Store the disassembled parts in a clean place to avoid loss.
5. After replacement, check the contacts and spare part mounting.
6. Assemble in the reverse order of disassembly.

CCD Board Screws

Screws for the CCD board in the optical unit are as shown. These screws have a red coating indicating they should never be loosened.

Flatbed CCD Optical Unit

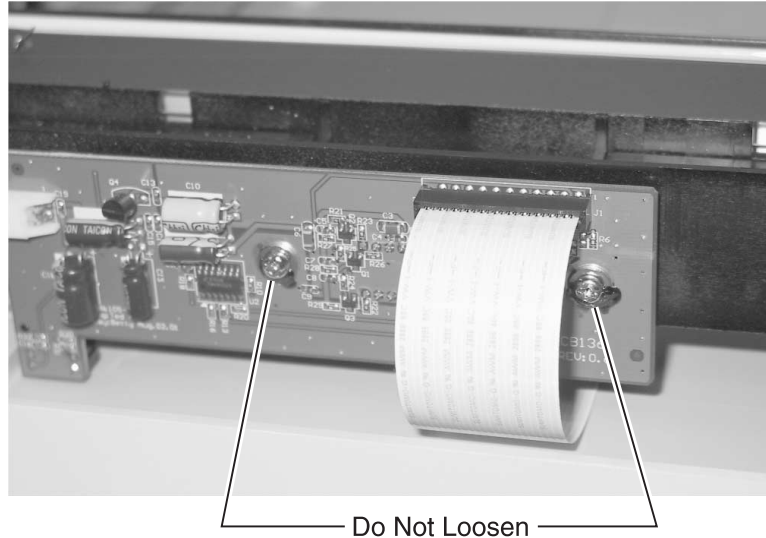

ADF CCD Optical Unit

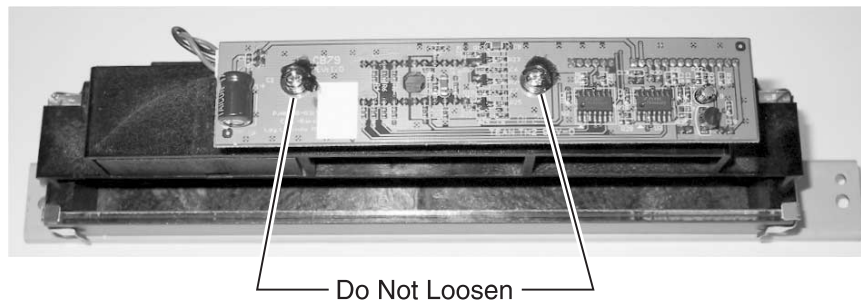

ADF Snap-in Pad Module Removal and Mounting

After scanning approximately 100,000 pages through the ADF, the ADF pad module may be worn and you may experience problems with document feeding. In this case, replace the ADF pad module.

To remove the ADF snap-in pad module:

1. Push the ADF unit backward.
2. Gently pull out the snap-in pad module.



To mount the ADF snap-in module,

1. Hold both arms of the snap-in pad module.
 2. Gently place the module into the pad holder.
- Note:** Inspect the feed roller and clean as necessary.

Document Cover Removal

Lift the document cover to remove the studs from the hinge holes. The studs are loosely attached to the hinge holes to accommodate the depth of the original.



ADF Cover Removal

Remove the two ADF cover screws and lift the ADF cover.

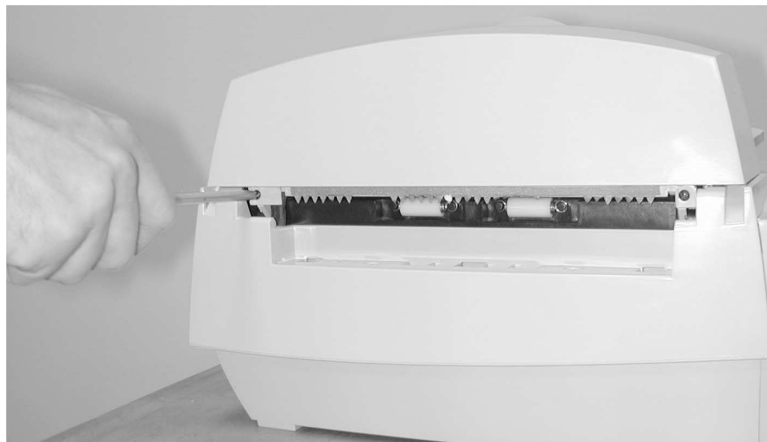

ADF Optical CCD Unit Removal

Warning: Do not loosen any screws with red coating.

1. Remove the ADF cover. Go to **“ADF Cover Removal”** on page 3-5. Remove the two screws from the ADF optical CCD unit as shown, and pull out the unit.

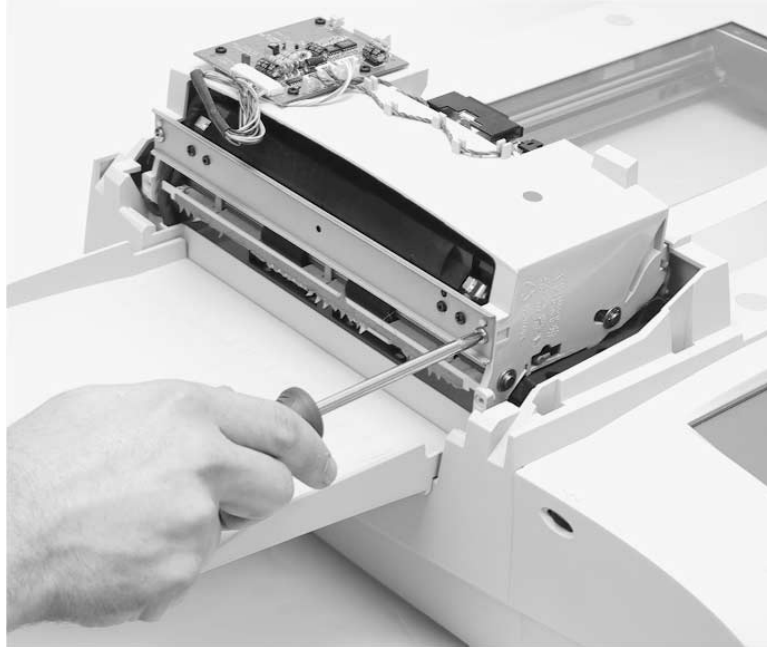

2. Use a flat screwdriver to raise the latch and remove the inverter board.
3. Disconnect the lamp connector from the inverter board.

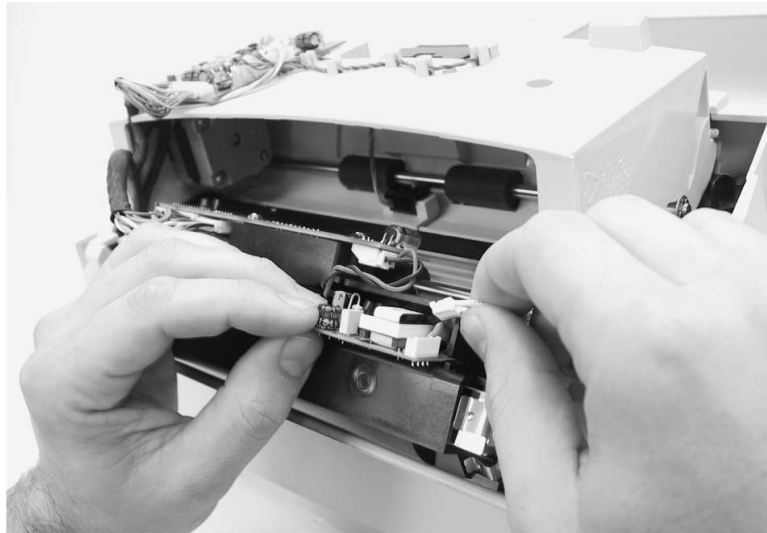

4. Disconnect the two CCD connectors.



5. Remove the ADF optical CCD unit.

ADF Unit (Upper and Lower Unit) Removal

1. Remove the ADF optical CCD unit. Go to **“ADF Optical CCD Unit Removal”** on **page 3-6**.
2. Remove the screws located at the four corners of the ADF unit.

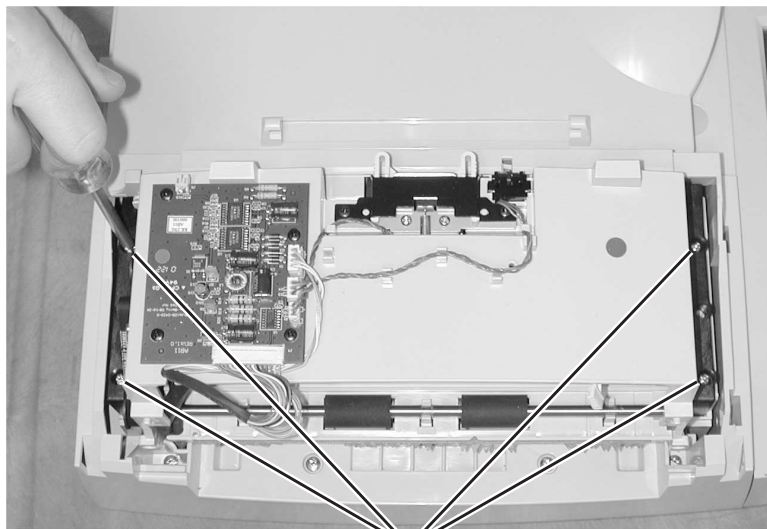

Screws

3. Disconnect 15PIN ADF motor/sensor cable from ADF motor/sensor card.

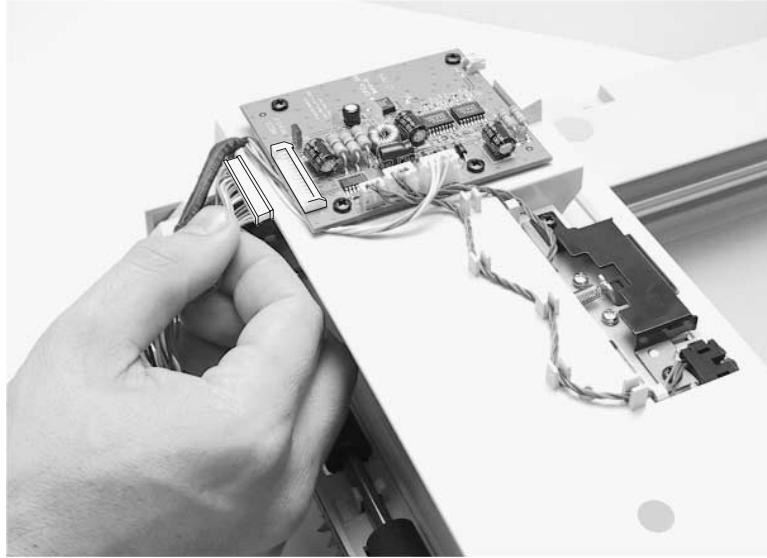

4. Lift the ADF unit and remove it.

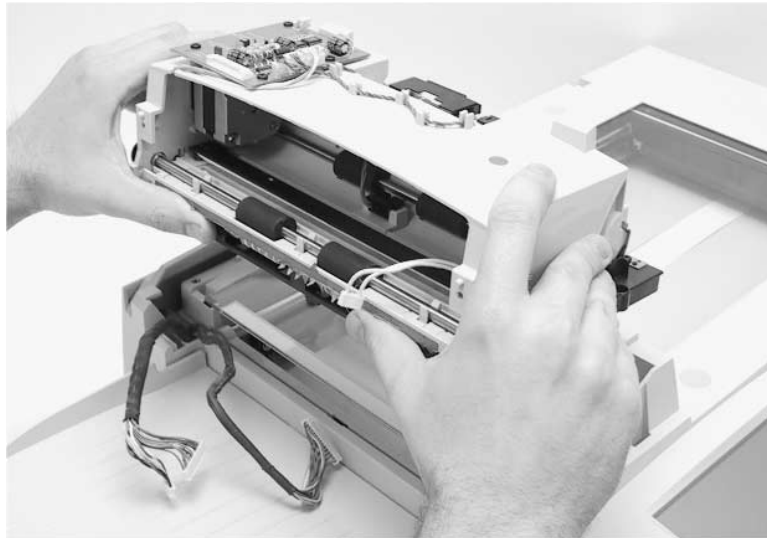

Note: The upper and lower units of the ADF unit can now be separated.

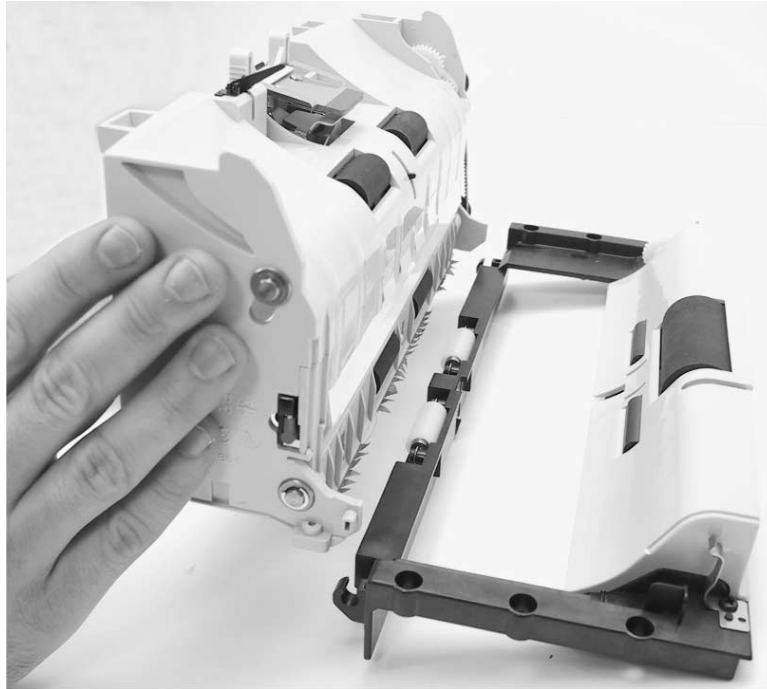

User Interface Removal

1. Remove the document output tray and document cover.
2. Place the scanner on its back.



3. Remove the three screws to loosen the user interface from the scanner.

4. Place the scanner right side up and slide the user interface forward.



5. Disconnect the cables.

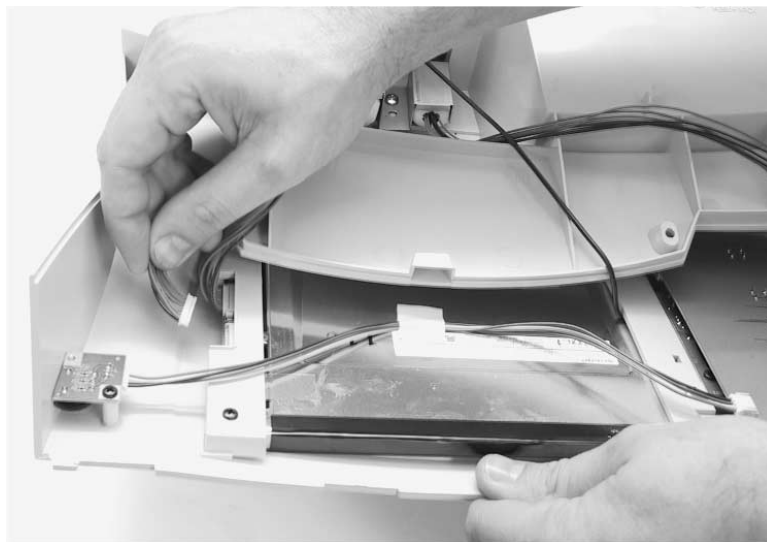

6. Remove the right side touch screen support bracket to disconnect the ground wire.

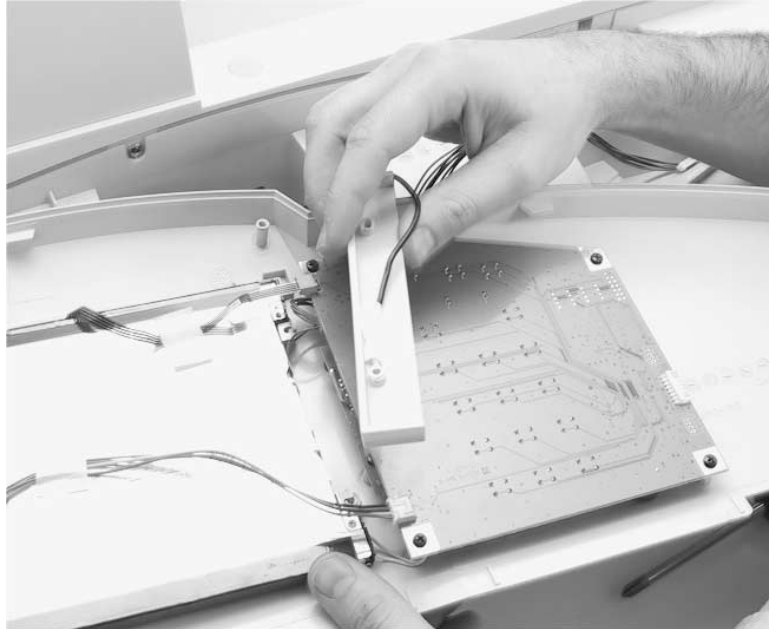

7. Remove the user interface gently.

Upper Housing Removal

1. Remove the ADF unit. Go to **“ADF Unit (Upper and Lower Unit) Removal”** on **page 3-7**.
2. Remove the user interface. Go to **“User Interface Removal”** on **page 3-9**.
3. Remove the four rubber pads with a flat screwdriver.
4. Remove the screws beneath the rubber pads.



5. Remove the four screws on the left side of the housing.



6. Remove the five screws from the front of the housing.



7. Remove the upper housing.

Flatbed CCD Optical Unit Removal

Warning: Do not loosen any screws with red coating.

1. Remove the upper housing. Go to **“Upper Housing Removal”** on page 3-12.
2. Press the pulley on the carriage belt pulley assembly toward the center of the unit and remove the carriage belt from the pulley.

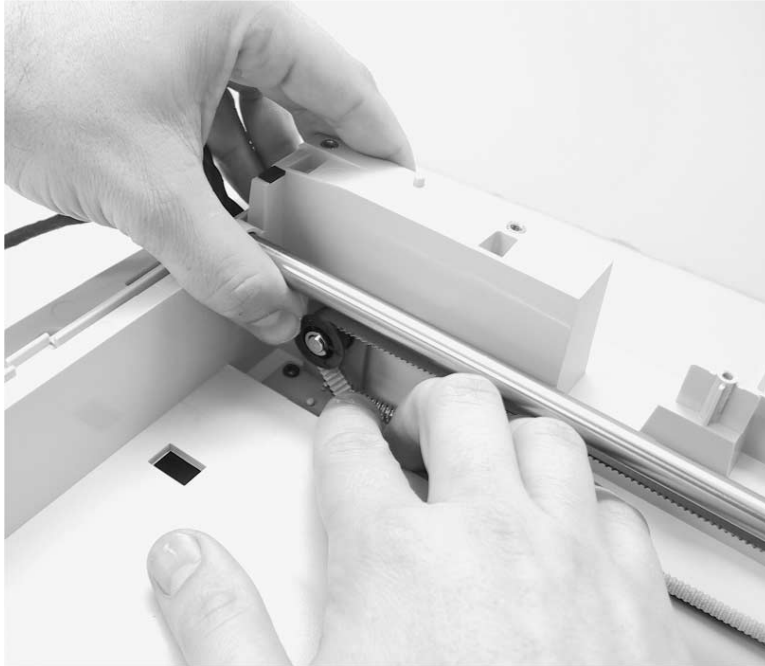

3. Remove the sliding rod and the flat cable. (See following figures.) **Warning:** Be very careful when handling the flatbed optical CCD. The lamp is exposed and can be easily broken. Do not touch.

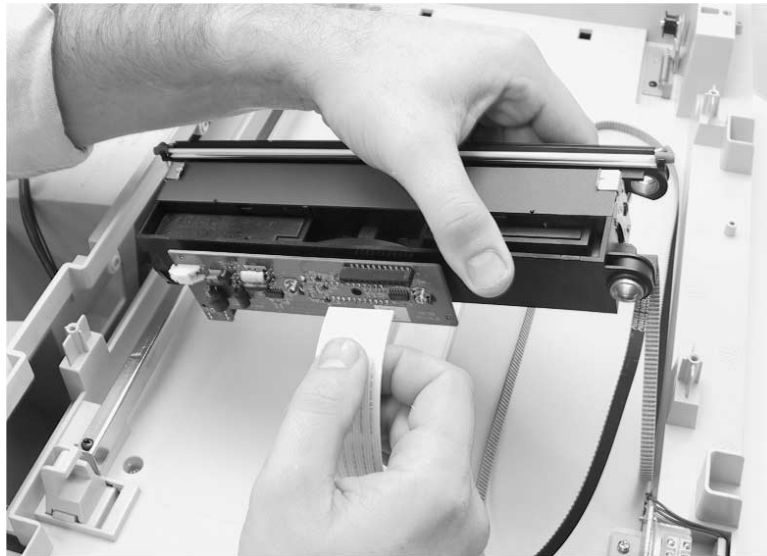
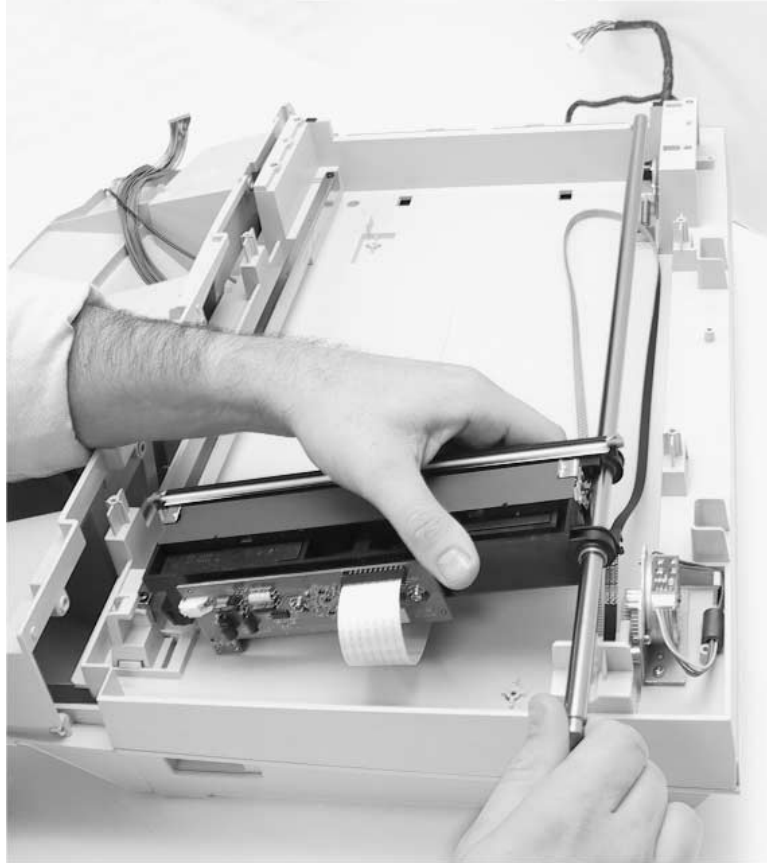

4. Take out the flatbed optical CCD.
5. Disconnect the belt from the side of the flatbed optical CCD.

Carriage Motor Assembly Removal

1. Remove the upper housing unit. Go to **“Upper Housing Removal”** on page 3-12.
2. Press the pulley on the carriage belt pulley assembly toward the center of the unit and remove the carriage belt from the pulley.
3. Disconnect connector from carriage motor assembly.
4. Remove the three screws from carriage motor assembly.
5. Remove the carriage motor.

Carriage Belt Pulley Assembly Removal

1. Remove the upper housing unit.
2. Press the pulley on the carriage belt pulley assembly toward the center of the unit and remove the carriage belt from the pulley.
3. Remove the two screws.
4. Remove the carriage belt pulley assembly.

MFD Controller Cage Removal

1. Remove the document output tray and document cover.
2. Place the scanner on its back.
3. Remove eight screws from the bottom housing.



4. Lower MFD controller cage and disconnect the three connectors and ground wire.



5. Swing the MFD controller cage assembly to the right and disconnect the two cables. Use a screwdriver on the lower cable connector to unlatch the connector.



6. Remove the MFD controller cage.

Note: When reinstalling the USB-style cable to the main control board, connect the cable to the upper connector.

Hard Disk Drive, MFD Controller Card, 1394 Communications Card and Power Distribution Board Removal

1. Remove the MFD controller cage. Go to **“MFD Controller Cage Removal”** on **page 3-16**.
2. With the MFD controller cage positioned upside down near an edge of a table, remove the two screws from the back side and three screws from the bottom.



3. Turn the MFD controller cage right side up and lift the upper shield from the cage.

4. Remove the component you want from within the MFD cage.



Main Control Board Removal

1. Remove the MFD controller cage. Go to **“MFD Controller Cage Removal”** on **page 3-16**.
2. Remove the screws securing the main control board.

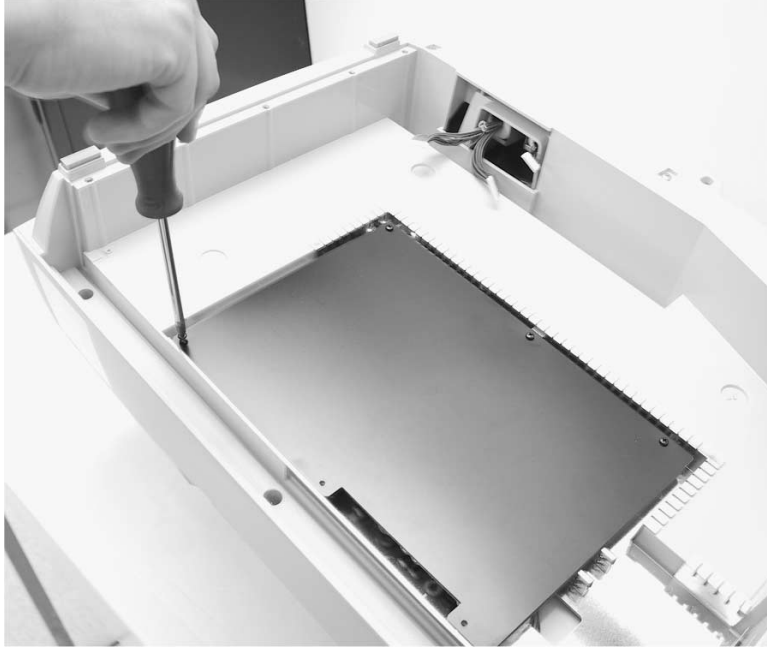

3. Disconnect the cables and remove the board.

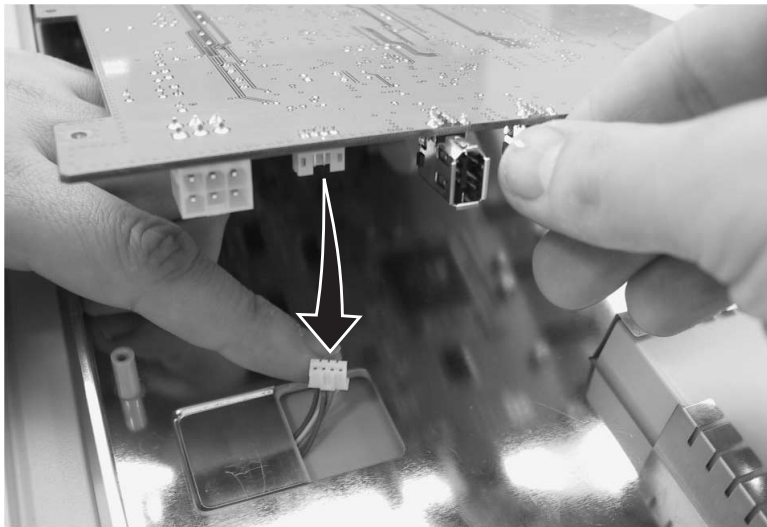

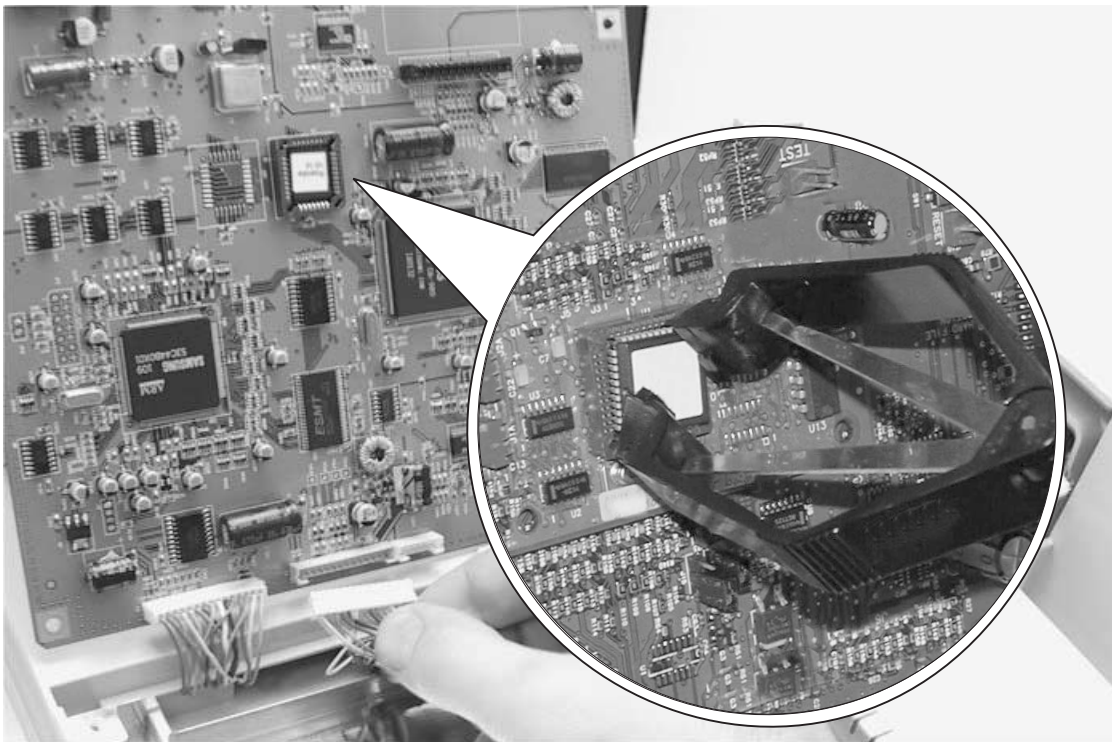

Note: When replacing the main scanner control board with a new one, remove the EPROM from the old board (with a chip puller) and install it in the new board. This EPROM contains settings unique to the scanner.

4. Connector Locations

The pin assignments shown are voltages and grounds which can be tested in the field. Use a multimeter grounded to the scanner MFD controller cage when measuring the voltage for the main scanner board.

Main Scanner Board

ADF Video Circuit J7:

Pin No.	Assignment
1	Ground
3	Ground
5	Ground

ADF Video Circuit J8:

Pin No.	Assignment
1	Ground
2	+24V dc
3	Ground
4	Ground
5	Ground
9	+5V dc
12	Ground
13	Ground
14	+24V dc

Flatbed Video Circuit J9:

Pin No.	Assignment
14	+24V dc
15	Analog Ground

MFD Controller Cage

All components within the MFD controller cage are self diagnosed. Any errors are reported as MFD controller cage errors.

Low Voltage Power Supply

The following diagram and chart represents the power supply output connector.

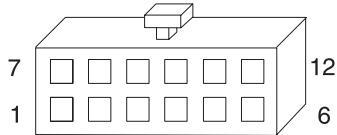

Pin No.	Wire Color	Assignment
1	Black	Ground
2	Black	Ground
3	Black	Ground
4	Black	Ground
5	Black	Ground
6	Black	Ground
7	White	+24V dc
8	Red	+5V dc
9	Yellow	+12V dc
10	Red	+5V dc
11	Red	+5V dc
12	Red	+5V dc

5. Parts Catalog

Assembly 1: Upper Scanner

Asm-Index	Part Number	Units	Description
1	56P2717	1	Tray, Document Input
2	56P0024	1	Cover, Scanner Document
3	56P0032	1	Cover, Upper with Glass
4	56P0020	1	User Interface, Complete
5	56P0030	1	Assembly, Lower ADF
6	56P0023	1	Tray, Document Output
7	56P0025	1	Assembly, ADF Optical Unit
8	56P0029	1	Assembly, Upper ADF
9	56P0079	1	Pad, Pick Roller
10	56P0028	1	Sensor, Paper Feed
11	56P0027	1	Sensor, Paper Present
12	56P0026	1	Board, ADF Motor/Sensor
13	56P2401	1	Cover, ADF Upper

Assembly 2: Lower Scanner

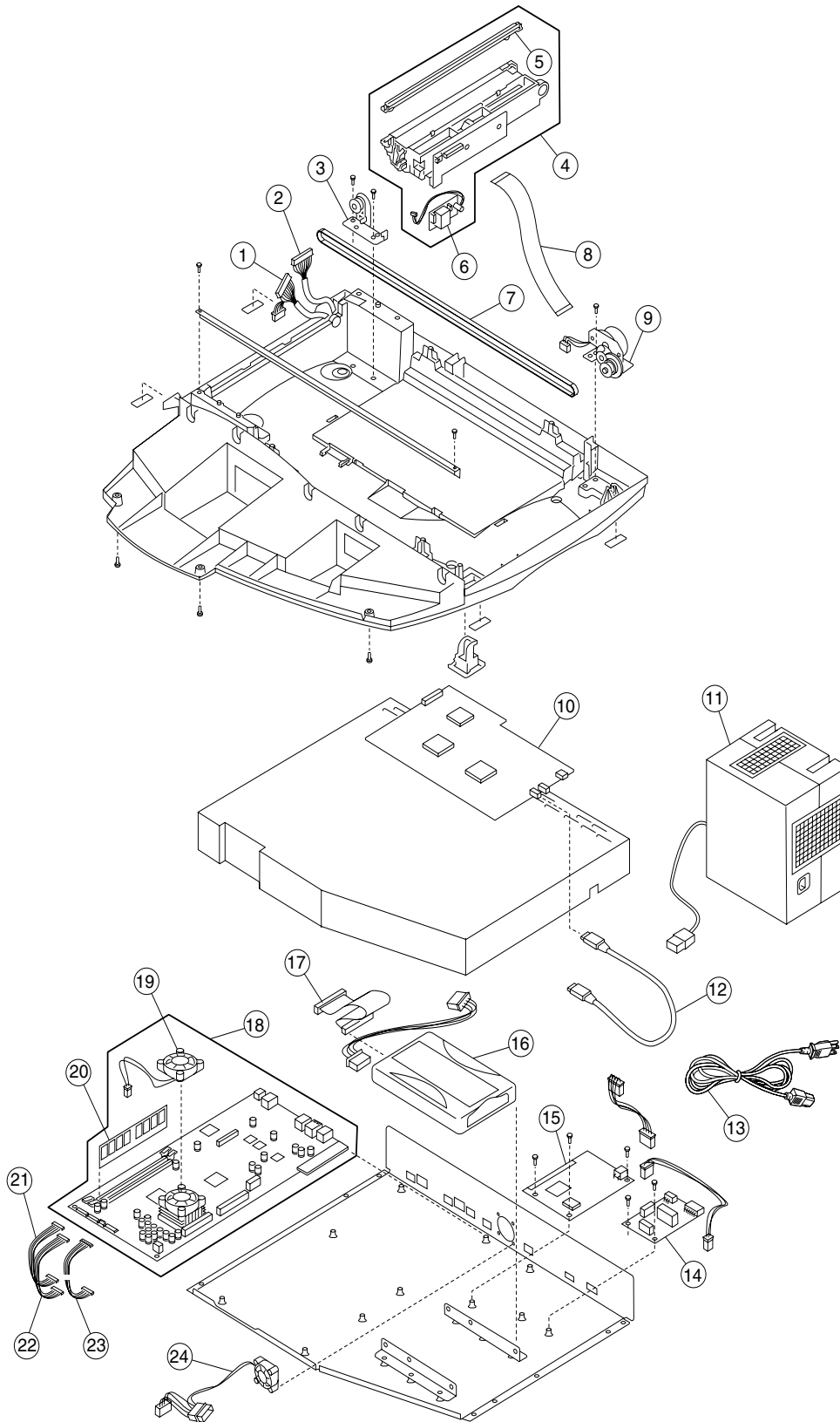

Assembly 2: Lower Scanner

Asm-Index	Part Number	Units	Description
1	56P0036	1	Cable, ADF CCD (6PIN + 14PIN)
2	56P0035	1	Cable, ADF Motor/Sensor (15PIN)
3	56P0033	1	Pulley Assembly, Carriage Belt
4	56P0031	1	Assembly, Flatbed CCD Optical Unit
5	56P1466	1	Lamp, Flatbed CCD
6	56P0308	1	Card Assembly, Flatbed CCD Lamp Invertor
7	56P0037	1	Belt, Carriage
8	56P0042	1	Cable, Flatbed Optical Unit
9	56P0034	1	Motor Assembly, Carriage
10	56P0021	1	Board, Main Scanner Control
11	12G6918	1	Power Supply, Universal, External
12	56P1473	1	Cable, 1394 Communications (generation 2)
13	11D0328	1	Line Cord, US, Canada, APG (LV), LAD (LV)
13	11D0329	1	Line Cord, Peru
13	11D0330	1	Line Cord, Argentina
13	11D0331	1	Line Cord, Brazil
13	11D0332	1	Line Cord, Chile
13	11D0333	1	Line Cord, Denmark
13	11D0334	1	Line Cord, France, Germany, Spain, Belgium, England, Europe
13	11D0335	1	Line Cord, Italy
13	11D0336	1	Switzerland
13	11D0337	1	Line Cord, UK, Ireland, Egypt
13	11D0338	1	Line Cord, Israel
13	11D0339	1	Line Cord, South Africa
13	99A0471	1	Line Cord, PRC
14	56P0192	1	Board, Power Distribution
15	56P0022	1	Board, 1394 Communications (used only with generation 1 controller board)
16	56P2467	1	Drive Assembly, Hard Disk
17	56P1472	1	Cable, HDD to Controller - 80 Conductor
18	56P2554	1	Board, Controller, WW non-Australia/New Zealand (generation 2)
18	56P2555	1	Board, Controller, Australia/New Zealand (generation 2)

Assembly 2 (cont.): Lower Scanner

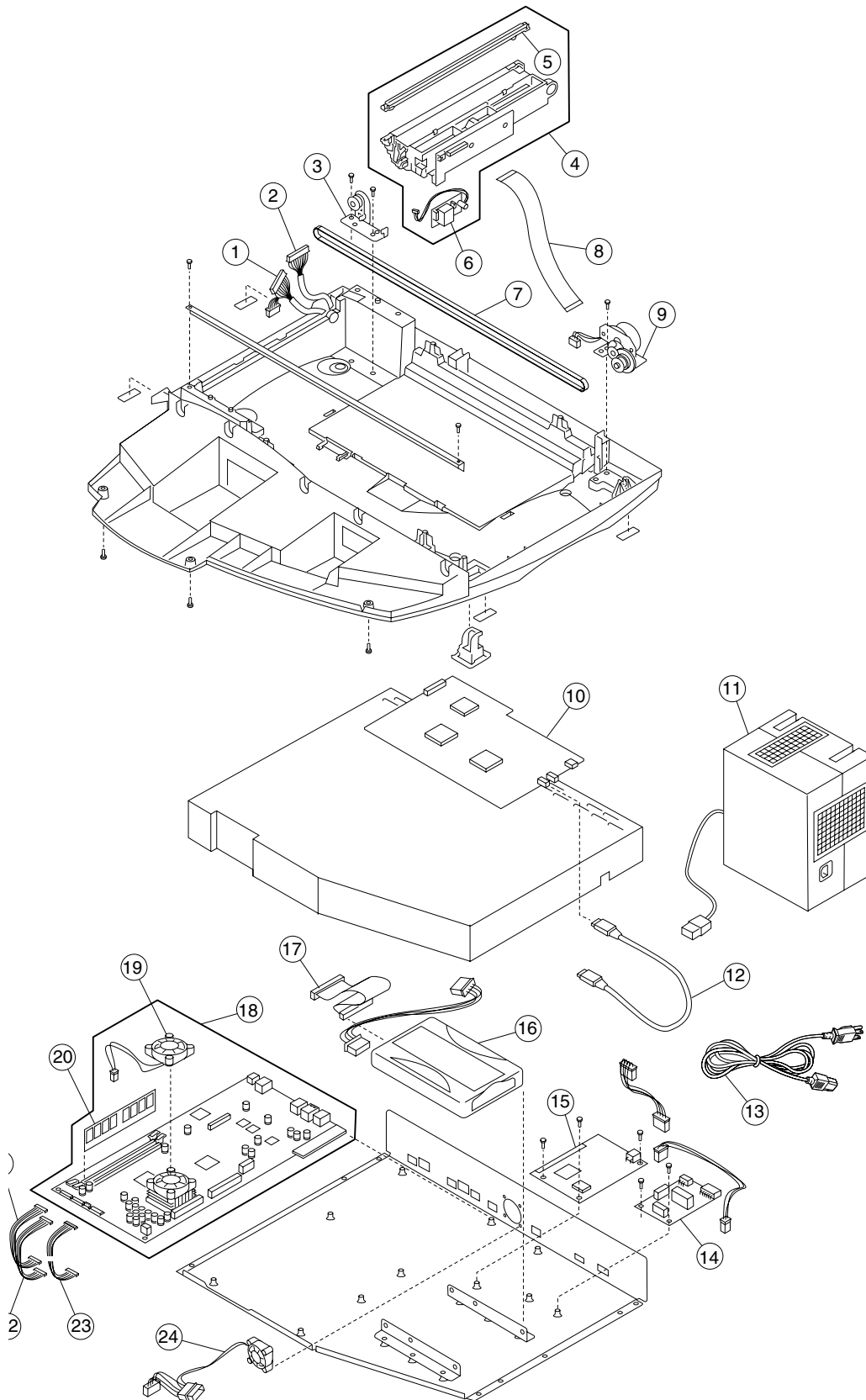

Assembly 2 (cont.): Lower Scanner

Asm-Index	Part Number	Units	Description
19	12G9063	1	Fan, CPU Cooling (used only with generation 1 controller board)
19	56P2406	1	Fan, CPU Cooling (used only with generation 2 controller board)
20	56P9910	1	Card Assembly, 128MB DIMM
21	56P2112	1	Cable, 15 pin User Interface
22	56P2110	1	Cable, 14 pin User Interface
23	56P2042	1	Cable, 7 pin User Interface
24	56P1808	1	Fan, Controller Cage Cooling
NS	56P0558	1	Cable, RJ11 with Torriod
NS	56P0559	1	Cable, RJ45 with Torriod
NS	56P1211	1	Adapter, UK phone

Note:

- Refer to LED pattern images on page **“MFD Controller Errors” on page 2-1** to identify controller board generation.
- If replacing a generation 1 MFD controller board with a generation 2 board, the following must be performed. The 1394 communications board and generation 1 1394 communications cable should be removed and discarded. In place of the discarded parts, a generation 2 1394 communications cable should be installed to connect the generation 2 MFD controller board to the main scanner control board. Included with the generation 2 1394 communications cable is an insulator which must be installed on a metal standoff on the controller cage. Instructions for installation are included with the generation 2 communications cable FRU.

Index

A

Abbreviations **1-9**

C

Cleaning

ADF Unit **3-1**

Cover and Glass **3-1**

Touch Screen **3-1**

Connector Locations **4-1**

E

Error Codes

MFD Controller **2-1**

Scanner **2-5**

M

Maintenance **3-1**

Maintenance Tools **3-2**

O

Overview **1-1**

P

Parts Catalog **5-1**

Parts Replacement **3-2**

Problem Solving **2-1**

Product Description **1-1**

Product Features **1-1**

Product Specifications **1-3**

R

Removals

ADF Cover **3-5**

ADF Optical CCD Unit **3-6**

ADF Snap-in Pad Module **3-4**

ADF Unit **3-7**

Carriage Belt Pulley Assembly **3-16**

Carriage Motor Assembly **3-16**

Communications Card, 1394 **3-19**

Document Cover **3-5**

Flatbed CCD Optical Unit **3-14**

Hard Disk Drive **3-19**

Main Control Board **3-21**

MFD Controller Cage **3-16**

MFD Controller Card **3-19**

Power Distribution Board **3-19**

Upper Housing **3-12**

User Interface **3-9**

S

Safety Information **v-v**

T

Theory of Operation

Mechanical Operation **1-5**

System Description **1-5**

Troubleshooting **2-7**

U

Unit **3-1**

Part Numbers

11D0328 **5-5**

11D0329 **5-5**

11D0330 **5-5**

11D0331 **5-5**

11D0332 **5-5**

11D0333 **5-5**

11D0334 **5-5**

11D0335 **5-5**

11D0336 **5-5**

11D0337 **5-5**

11D0338 **5-5**

11D0339 **5-5**

12G6918 **5-5**

12G9063 **5-7**

56P0020 **5-3**

56P0021 **5-5**

56P0022 **5-5**

56P0023 **5-3**

56P0024 **5-3**

56P0025 **5-3**

56P0026 **5-3**

56P0027 **5-3**

56P0028 **5-3**

56P0029 **5-3**

56P0030 **5-3**

56P0031 **5-5**

56P0032 **5-3**

56P0033 **5-5**

56P0034 **5-5**

56P0035 **5-5**

56P0036 **5-5**

56P0037 **5-5**

56P0042 **5-5**

56P0079 **5-3**

56P0192 **5-5**

56P0308 **5-5**

56P0558 **5-7**
56P0559 **5-7**
56P1211 **5-7**
56P1466 **5-5**
56P1472 **5-5**
56P1473 **5-5**
56P1808 **5-7**
56P2042 **5-7**
56P2110 **5-7**
56P2112 **5-7**
56P2401 **5-3**
56P2406 **5-7**
56P2467 **5-5**
56P2554 **5-5**
56P2555 **5-5**
56P2717 **5-3**
56P9910 **5-7**
99A0471 **5-5**

Free Manuals Download Website

<http://myh66.com>

<http://usermanuals.us>

<http://www.somanuals.com>

<http://www.4manuals.cc>

<http://www.manual-lib.com>

<http://www.404manual.com>

<http://www.luxmanual.com>

<http://aubethermostatmanual.com>

Golf course search by state

<http://golfingnear.com>

Email search by domain

<http://emailbydomain.com>

Auto manuals search

<http://auto.somanuals.com>

TV manuals search

<http://tv.somanuals.com>