



POWER AVAILABILITY

# PowerSure™ PST

USER MANUAL

500-650 VA  
230V





---

# TABLE OF CONTENTS

<b>IMPORTANT SAFETY INSTRUCTIONS</b> . . . . .	<b>1</b>
<b>INTRODUCTION AND SYSTEM DESCRIPTION</b> . . . . .	<b>4</b>
Top and Side Views of UPS . . . . .	5
<b>MAJOR COMPONENTS</b> . . . . .	<b>6</b>
Transient Voltage Surge Suppression (TVSS) & EMI / RFI Filters . . . . .	6
Transfer Switch . . . . .	6
Battery Charger . . . . .	6
Battery . . . . .	6
Inverter . . . . .	6
<b>WHAT'S INCLUDED</b> . . . . .	<b>7</b>
<b>INSTALLATION</b> . . . . .	<b>8</b>
<b>CONTROLS AND INDICATORS</b> . . . . .	<b>10</b>
ON/OFF/Alarm Silence Button . . . . .	10
Status Indicators: Mains/Battery, Fault. . . . .	11
Mains/Battery Indicator (Green) . . . . .	11
Fault Indicator (Red) . . . . .	11
Location and Status of Indicators . . . . .	11
<b>MODES OF OPERATION</b> . . . . .	<b>12</b>
Normal Mode . . . . .	12
Battery Mode . . . . .	12
<b>COMMUNICATIONS</b> . . . . .	<b>13</b>
USB Interface Port. . . . .	13
Data Line Protection Connectors . . . . .	13
<b>MAINTENANCE</b> . . . . .	<b>14</b>
Cleaning the UPS. . . . .	14
Maintaining Batteries . . . . .	14
<b>TROUBLESHOOTING</b> . . . . .	<b>15</b>
Guide to Status Indicators. . . . .	15
Troubleshooting Chart. . . . .	16
<b>SPECIFICATIONS</b> . . . . .	<b>17</b>
Battery Run Times. . . . .	18



---

## IMPORTANT SAFETY INSTRUCTIONS

---

### SAVE THESE INSTRUCTIONS

This manual contains important safety instructions that should be followed during the installation and maintenance of the Uninterruptible Power System (UPS) and its batteries. Please read this manual thoroughly before attempting to install or operate this UPS.

Read all safety, installation, and operating instructions before operating the UPS. Adhere to all warnings on the unit and in this manual. Follow all operating and user instructions.

This equipment is designed for Commercial, Industrial or Home use. Liebert Corporation neither recommends nor knowingly sells this product for use in life support applications or with other designated critical devices.

This equipment can be installed and operated by individuals without previous training.



### WARNING

#### SAFETY PRECAUTIONS

- There are no user-serviceable parts inside this UPS. Refer all UPS and battery service to qualified service personnel. Do not attempt to service this product yourself.
- Output receptacles on the UPS are electrically live if the UPS is switched on, even if the UPS is not plugged into a Mains supply. The ON/OFF button on the UPS does not electrically isolate the internal parts. Some components are live even when Mains power is disconnected. To isolate the UPS, switch off the UPS first, then unplug it from the Mains.
- Opening or removing the cover may expose you to lethal voltages within this unit even when it is apparently not operating and the input wiring is disconnected from the electrical source.
- Observe all CAUTION and WARNING statements in this manual and on the unit. Failure to do so may result in serious injury or death.
- Never work alone.
- This UPS should not be supplied from electrical power systems of the "IT" (Impedance á Terre) type (IEC 364 - Electrical Installation of Buildings).
- The UPS must be earthed/grounded at all times during operation. Connect only to a mains supply socket outlet with an earth/ground connection.



## CAUTION

Although your UPS has been designed and manufactured to assure personal safety, improper use may result in electrical shock or fire. To ensure safety, please observe the following rules:

- Turn off and unplug your UPS before cleaning. Do not use liquid or aerosol cleaners. A dry cloth is recommended to remove dust from the surface of your UPS.
- Do not install or operate your UPS in or near water.
- Do not place your UPS on an unstable cart, stand or table.
- Do not place your UPS in direct sunlight or near heat emitting sources.
- Never block or insert any objects into the ventilation holes or other openings of the UPS. Keep all vents free of dust accumulation that could restrict airflow.
- Do not place UPS power cord in any area where it may be damaged by heavy objects.
- Placing magnetic storage on the top of the UPS may result in data corruption.



## CAUTION

### BATTERY HANDLING PRECAUTIONS

Servicing of batteries should be performed or supervised by personnel knowledgeable of batteries and required precautions. Keep unauthorized personnel away from the batteries.

A battery can present a risk of electrical shock and high short-circuit current. The following precautions should be observed when working on batteries:

- Remove watches, rings, and other metal objects.
- Use tools with insulated handles.
- Do not dispose battery or batteries in a fire. The battery may explode.
- Do not open or mutilate the battery or batteries. Released electrolyte is harmful to skin and eyes. It may be toxic.
- When replacing the battery, use same number and type of battery as the suitable recommended type of battery listed in specification table in back of this manual.
- Handle, transport and recycle batteries in accordance with local regulations.



## CAUTION

If your UPS demonstrates any of the following conditions, turn off and unplug your UPS from the outlet and contact your local dealer, Liebert representative, or Liebert Worldwide Support Group.

- The power cord is damaged.
- Liquid has been spilled on the UPS.
- The circuit breaker or fuse opens frequently.
- The UPS does not operate in accordance with the user manual.

**Electromagnetic Compatibility**—The PowerSure™ PST series complies with the requirements of the EMC Directive 89/336/EEC and the published technical standards. Continued compliance requires installation in accordance with these instructions and use of Liebert approved accessories only.

**Environmental**—Operate the UPS in an indoor environment only in an ambient temperature range of 0°C to 40°C (32°F to 104°F). Install in a clean environment, free from conductive contaminants, moisture, flammable liquids, gases, or corrosive substances.

Provided is a USB cable for connection to a computer. Store in a safe place if not required at this time.

---

## INTRODUCTION AND SYSTEM DESCRIPTION

---

Congratulations on your choice of the Liebert PowerSure™ PST Uninterruptible Power System (UPS). It provides filtered AC power to sensitive electronic equipment and other critical loads.

The PowerSure PST is an off-line UPS designed for desktop applications. It provides perfect one-to-one power protection for electronic equipment such as PCs, point-of-sale displays, home office equipment and similar electronic gear. The PowerSure PST is available in two (2) sizes: 500 and 650VA at 230VAC.

PowerSure PST models are available for 120VAC and 230VAC supply voltages and loads. Please verify that this model matches your AC Mains and load voltage requirements.



# Top and Side Views of UPS

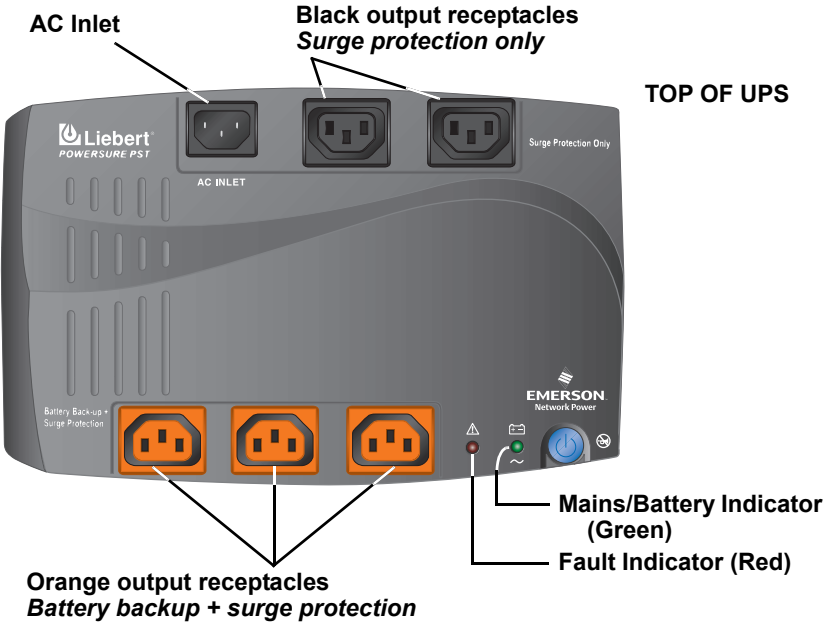

## RIGHT SIDE OF UPS

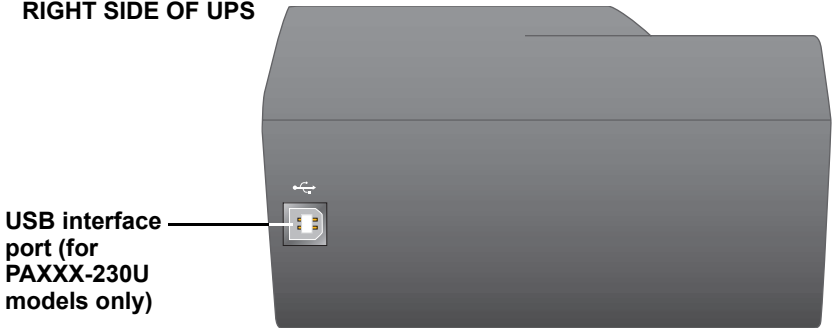

## LEFT SIDE OF UPS

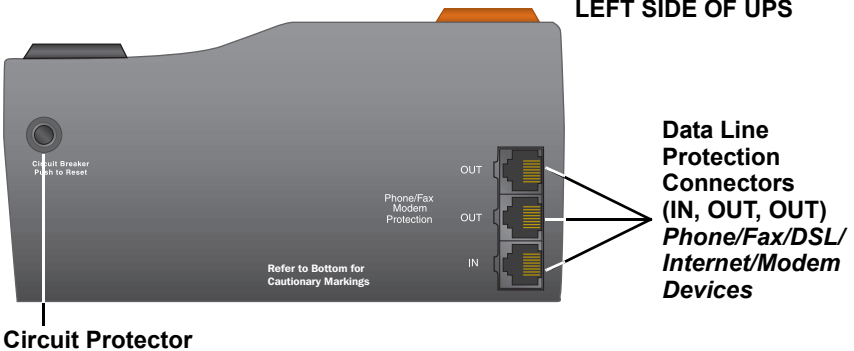

---

## MAJOR COMPONENTS

---

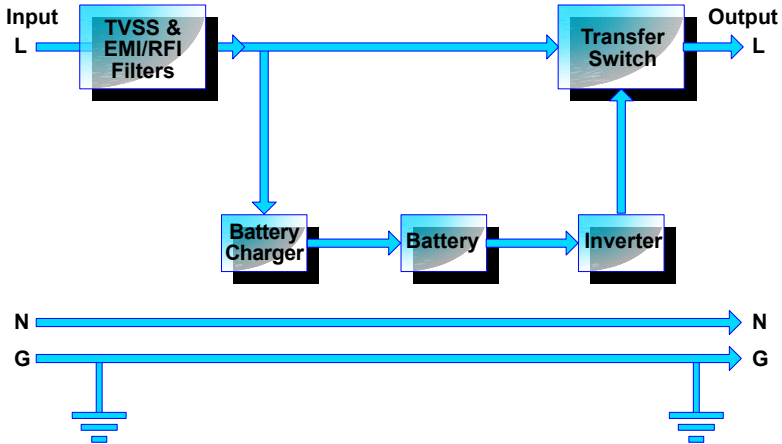

### Transient Voltage Surge Suppression (TVSS) & EMI / RFI Filters

These UPS components provide surge protection and filter electromagnetic interference (EMI) and radio frequency interference (RFI). They minimize surges or interference present in the mains line and keep the sensitive equipment protected.

### Transfer Switch

In Normal mode the Transfer Switch passes mains AC power to the connected load. When input mains voltage or frequency is outside acceptable limits, the transfer switch activates and transfers the UPS to battery.

### Battery Charger

In Normal mode, the Battery Charger converts mains AC power into regulated DC power to float charge the battery. It is continuously charging the battery whenever the UPS is plugged into a power outlet and mains power is within acceptable limits—even if the UPS is turned OFF.

### Battery

The PowerSure PST utilizes a valve-regulated, nonspillable, lead acid battery. To optimize battery life, operate the UPS in an ambient temperature of 20°-25°C (68°-77°F).

### Inverter

When mains power fails, the Inverter draws energy from the battery and inverts it into a regulated stepped sinewave supplying power for equipment connected to the orange receptacles.

---

## WHAT'S INCLUDED

---

The PowerSure PST is shipped with the following items:

- PowerSure PST user manual
- USB cable (PAXXX-230U models only), 1.8m (6 ft.)
- RJ-11 cord, 2.1m (7 ft.)
- Two (2) 10A output power cords, 2.0m (6.6 ft.)

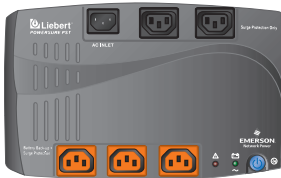

**PowerSure PST**



**USB cable  
1.8m (6 ft.)  
(for PAXXX-230U  
models only)**



**RJ-11 cord  
2.1m (7 ft.)**

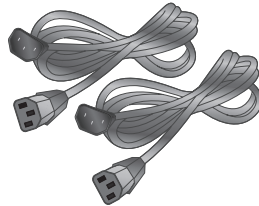

**Two (2) 10A  
output power cords  
2.0m (6.6 ft.)**

---

## INSTALLATION

---

This UPS is designed for data processing equipment. Maximum load must not exceed that shown on the UPS rating label. Do not connect equipment that could overload the UPS or draw half-wave current from the UPS, for example: electric drills, vacuum cleaners, laser printers or hair dryers. Your total load earth leakage current must not exceed 3.5 mA. Most data processing equipment meets this requirement if you use no more than two pieces of equipment. If uncertain about your load, consult your local dealer, Liebert representative, or Liebert Worldwide Support Group.

1. Visually inspect the UPS for freight damage. Report damage to the carrier and your local dealer, Liebert representative or the Liebert Worldwide Support Group.
2. Decide where to place the PowerSure PST. Install the UPS indoors in a controlled environment, where it cannot be accidentally turned off. Place it in an area of unrestricted airflow around the unit, away from water, flammable liquids, gases, corrosives, and conductive contaminants. Maintain an ambient temperature range of 0°C to 40°C (32°F to 104°F).



### NOTE

*UPS operation in temperatures above 25°C (77°F) reduces battery life.*

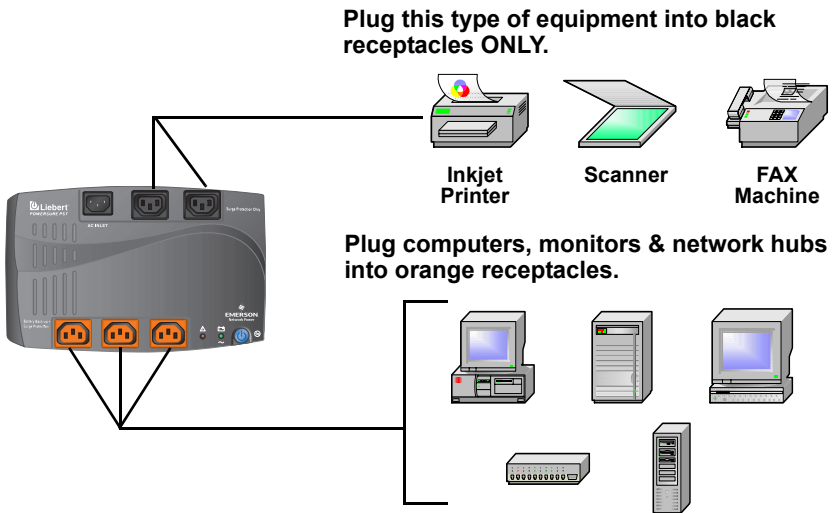

3. The PowerSure™ PST 230VAC models are not supplied with an input power lead for connection to the mains supply. Additional input/output leads can be obtained from your dealer.

4. Shut down the load equipment and turn off the mains supply. Unplug the load equipment's power input cable from the mains supply socket and plug it into the UPS input socket. Plug the power input cable into the mains supply socket. Connect the supplied output cable between the load equipment input socket and one of the UPS AC output sockets. Connect all load equipment to the UPS in this manner.
5. Plug any computers and monitors into the orange battery backed up receptacles. Other office machines that do not exceed the capacity of the UPS—inkjet printers, scanners and fax machines—may be plugged into either of the two (2) black receptacles, which provide surge protection only.
6. Connect Phone/Fax/DSL/Internet/Modem devices to data line connectors.

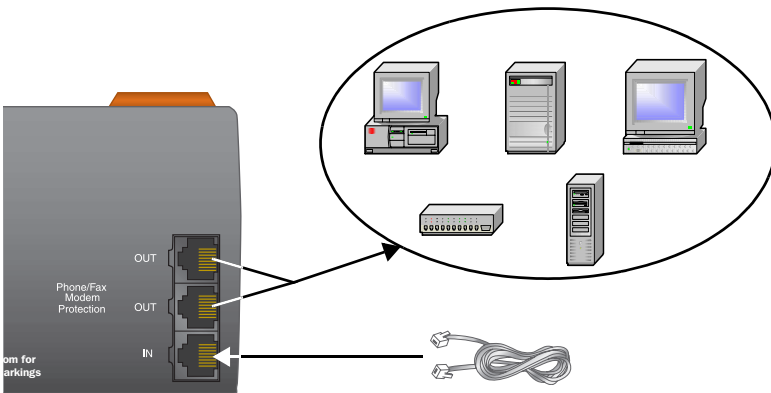

7. Press and release the ON/OFF/Alarm Silence button to turn on the UPS. The UPS will beep and the Mains/Battery Indicator will illuminate (green).
8. Turn on connected equipment.
9. If your PST has the optional USB port (available on models with extension “-230U”):

Connect the USB cable provided with the UPS to the USB ports on the PST and your computer. The PST will work automatically with your built-in power management software on Windows XP and 2000 and Mac OS 10.2 or later (see **USB Interface Port** section for details).



#### NOTE

*When using the communication features on this UPS, ensure the cabling connected to the UPS communications ports are kept separated from the power leads to the UPS input and output.*

---

## CONTROLS AND INDICATORS

---

### ON/OFF/Alarm Silence Button



This button controls output power to the connected load and has three functions:

- ON
- OFF
- Alarm Silence

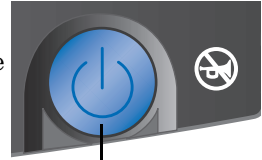

ON/OFF/Alarm Silence

**ON** When the UPS is off, pressing the main ON/OFF button for more than two seconds will start the UPS, and an audible alarm sounds briefly. The UPS is capable of starting on battery (*battery start*).

**OFF** When the UPS is on (in either Normal or Battery mode), pressing the main ON/OFF button for **more than two (2) seconds** will shut down the UPS. An audible alarm sounds briefly.

**Alarm Silence** When a UPS audible alarm is active, pressing and releasing the main ON/OFF button will silence the active audible alarm, whether mains power is present or not. Once the alarm silence function has been activated, all active audible alarms—except for low battery or overload conditions—will remain silenced until a new alarm condition is detected.



#### NOTE

*Do not hold ON/OFF button down for more than 2 seconds or the UPS will shut down.*

---

## Status Indicators: Mains/Battery, Fault

There are two (2) status indicators on the top panel of the UPS, as shown in the diagram below. Each indicator illuminates to specify the status of the UPS (see **Troubleshooting** section for details).

### Mains/Battery Indicator (Green)

The Mains/Battery Indicator illuminates when the UPS is operating in Normal mode, supplying power to connected loads. The Mains/Battery Indicator flashes when the UPS is operating in Battery mode.

### Fault Indicator (Red)

The Fault Indicator illuminates when the UPS detects an internal fault. It flashes if the UPS detects an overload condition.

### Location and Status of Indicators

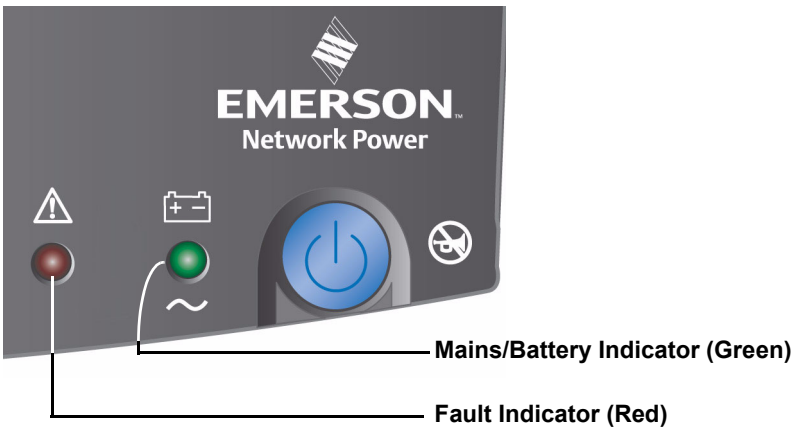

---

# MODES OF OPERATION

---

## Normal Mode

During Normal mode operation, the PowerSure PST supplies conditioned, computer-grade power to the connected equipment: mains power passes through the TVSS circuitry, EMI/RFI filters and then through the Transfer Switch to the connected equipment.

When the UPS is in Normal mode, the Mains/Battery Indicator illuminates green.

The PowerSure PST continuously monitors the batteries to maintain them in a fully charged state. The battery charger operates whenever AC power is present, even if the UPS is switched off. The UPS performs an automatic battery test after it has been operating continuously for two (2) weeks.



**Continuous indicator illumination denotes Normal Mode**

## Battery Mode

The UPS switches to Battery mode in the event of an extreme voltage/frequency condition or complete mains failure. The battery system supplies power through the Inverter to generate power for connected equipment. When the UPS is in Battery mode, the Mains/Battery Indicator **flashes** green and an alarm sounds every 5 seconds.



**Flashing indicator illumination denotes Battery Mode**

When a low battery condition occurs, the Battery Indicator continues to flash green and the alarm sounds every half-second. Low battery warning is initiated when approximately two (2) minutes of battery run time are remaining. For more information, refer to **Troubleshooting** section.



## CAUTION

Turning off the UPS while in either Normal mode or Battery mode will result in the loss of output power.



## NOTE

*Once mains power is restored, the UPS resumes normal operation. At this time, the battery charger begins recharging the battery. The UPS is capable of OFF-State charging, i.e., with mains power, the UPS will charge the batteries as long as it is plugged in.*



### USB Interface Port

The PowerSure PST models with extension “-230U” have a USB interface port for communication that will work with the built-in Microsoft Power Manager software on the user’s PC, if the PC is so equipped. It will provide UPS status and manages the automatic, orderly shut-down of the computer. The UPS (USB) communications meets HID standard, version 1.11. All USB models are compatible with Microsoft Windows 2000, Windows XP and Mac OS 10.2 or later. All USB models ship with a 1.8m (6 ft.) USB cable.



Microsoft, Windows, and the Windows logo are trademarks, or registered trademarks of Microsoft Corporation in the United States and/or other countries.

### Data Line Protection Connectors

Data line (1 input & 2 outputs) connectors are located on the rear of the UPS and provide transient voltage surge suppression (TVSS) for Phone/Fax/DSL/Internet/Modem devices.

---

## **MAINTENANCE**

---

The PowerSure PST UPS requires very little maintenance. Follow these practices to prevent problems.

### **Cleaning the UPS**

The following will help ensure trouble-free operation for years:

- Vacuum dust from the ventilation intake occasionally.
- Wipe the cover periodically with a dry cloth.

### **Maintaining Batteries**

The batteries are valve-regulated, nonspillable, lead acid and must be kept charged to retain their design life. The UPS continuously charges the batteries when connected to the mains supply, even while the UPS is switched off.

When storing the UPS, it is recommended to plug in UPS for at least 24 hours every four to six months to ensure full recharge of the batteries.





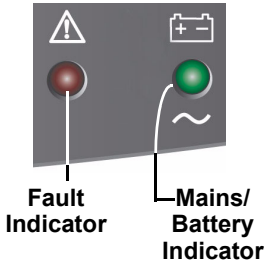











# TROUBLESHOOTING

The information below indicates various symptoms a user may encounter in the event the PowerSure PST experiences a problem. Use this information to determine whether external factors caused the problem. See **Troubleshooting Chart** for suggested remedy.



1. The Fault Indicator illuminates, indicating the UPS detected a problem.
2. An alarm sounds, alerting that the UPS requires attention. The alarm can be silenced except for low battery and overload warning conditions.
3. Mains/Battery Indicator may be illuminated as a diagnostic aid to the operator, as shown below:

## Guide to Status Indicators

Fault (Red)	Mains/Battery (Green)	Diagnosis/ Audible Alarm
		
<b>Normal Mode</b>		
—	 ON	UPS is operating in Normal Mode; no beep.
—	 Flashing	Battery Test has been initiated; no beep.
 Flashing	 ON	The unit is overloaded; beep every half-second
 ON	 ON	The UPS has failed; continuous beep
 Flashing	—	Unit has shutdown due to overload; continuous beep
 ON	—	The UPS shutdown due to failure; continuous beep
<b>Battery Mode</b>		
—	 Flashing	The UPS is operating in Battery mode; beep every 5 seconds.
—	 Flashing	UPS battery is low; beep every half-second
 Flashing	 Flashing	The unit is overloaded; beep every half-second
 ON	 Flashing	The UPS has failed; continuous beep

## Troubleshooting Chart

If the UPS fails to operate properly, turn off the unit and repeat the steps in the **Installation** section of this manual. If the problem persists, refer to the chart below:

Problem	Cause	Solution
<b>UPS will not start</b>	Overload/ Short circuit	Check the circuit protector on the side of the UPS. If it is tripped, reset it and restart the UPS. For further help, call your local dealer, Liebert representative or the Liebert Worldwide Support Group.
<b>UPS starts on battery, but will not switch to AC</b>	UPS not plugged in	Plug in power cord securely.
	Circuit protector tripped	Reset the circuit protector and restart the UPS.
	Power not available at mains receptacle	Have the mains receptacle checked by a qualified electrician.
	Input voltage below threshold	Wait until the voltage rises to an appropriate level or have the mains receptacle checked by a qualified electrician.
	AC overvoltage	Wait until voltage lowers to an appropriate level or have the mains receptacle checked by a qualified electrician.
<b>UPS shuts down, Fault Indicator lit</b>	Overload/ Short circuit	Check the circuit protector on the rear of the UPS. If it is tripped, reset it and restart the UPS.
	Internal UPS fault	If the problem persists, disconnect some of the equipment from your UPS—the total wattage of your equipment must not exceed the capacity of the UPS. For further help, call your local dealer, Liebert representative or the Liebert Worldwide Support Group.
<b>UPS not providing expected backup time</b>	Overload	Reduce load.
	Battery not charged due to a recent outage	Recharge battery.

# SPECIFICATIONS

Model Number	PA500-230U PA500-230	PA650-230U PA650-230
Model Rating VA / W	500 / 300	650 / 360
<b>DIMENSIONS: mm (in.)</b>		
Unit W x D x H	168 x 250 x 95 (6.6 x 9.8 x 3.7)	168 x 250 x 95 (6.6 x 9.8 x 3.7)
Shipping W x D x H	238 x 350 x 142 (9.4 x 13.8 x 5.6)	238 x 350 x 142 (9.4 x 13.8 x 5.6)
<b>WEIGHT: kg (lbs)</b>		
Unit	4.7 (10.4)	5.7 (12.5)
Shipping	5.7 (12.5)	6.7 (14.8)
<b>INPUT AC PARAMETERS</b>		
Surge Protection	220J	
Rated Input Voltage	230VAC	
Voltage Range Without Battery Operation	180VAC - 264VAC (±6VAC)	
Frequency	47 - 63 Hz (±0.4 Hz)	
<b>OUTPUT AC PARAMETERS</b>		
Output Receptacles	(3) IEC-320-C13 (orange) battery backup+surge protection (2) IEC-320-C13 (black) surge protection	
Output Cord	2m (6.6 ft) detachable, w/IEC-320 (Wire Type: 1mm <sup>2</sup> , H05W-F 3G)	
Voltage (Battery Mode)	230VAC (±8%)	
Output Current	2.9 A	4.2 A
Waveform (Battery Mode)	Stepped Sinewave	
Frequency (Battery Mode)	50/60 Hz (±1 Hz)	
Overload Warning	>100%	
Overload Shutdown	>110%	
<b>BATTERY PARAMETERS</b>		
Type	Valve-regulated, nonspillable, lead acid	
Quantity x Voltage x Rating	1 x 12V x 5 Ah	1 x 12V x 7 Ah
Transfer Time	4 – 6 ms typical	
Back-up Time:	At 25°C (77°F), resistive loading, w/ fully charged batteries:	
Full load	2 minutes	1 minute
Half load	8 minutes	8 minutes
Recharge Time	12 hours to 90% rated capacity, after full discharge into resistive load	

<b>ENVIRONMENTAL</b>	
Operating Temperature	0°C to +40°C (+32°F to + 104°F)
Storage Temperature	-15°C to +50°C (+5°F to + 122°F)
Relative Humidity	0% to 95%, non-condensing
Operating Elevation	Up to 3000 m (10,000 ft.) at 35°C (95°F) w/o derating
Audible Noise	< 40 dBA, at 1 meter
<b>AGENCY</b>	
Safety	EN50091-1-1, TUV/GS listed, CE Compliance Mark
Surge	EN61000-4-5, Level 3, Criteria A
ESD	EN61000-4-2, Level 3, Criteria A
Susceptibility	EN61000-4-3, Level 2, Criteria A
Electrical Fast Transient/ Burst	EN61000-4-4, Level 3, Criteria A
Emissions	EN50091-2, Class B
Harmonics	EN61000-3-2
Conducted Immunity	EN61000-4-6
Flicker	EN61000-3-3
Transportation	ISTA Procedure 1A

## Battery Run Times

Load %	500VA	650VA
5	95	117
10	53	73
20	25	35
30	19	20
40	12	12
50	8	8
60	7	7
70	5	4
80	3	3
90	3	2
100	2	1

**Note:** Approximate discharge times are in minutes and at 25°C (77°F) with resistive load.



# PowerSure™ PST

## USER MANUAL

### The Company Behind the Products

With over a million installations around the globe, Liebert is the world leader in computer protection systems. Since its founding in 1965, Liebert has developed a complete range of support and protection systems for sensitive electronics:

- Environmental systems—close-control air conditioning from 1 to 60 tons
- Power conditioning and UPS with power ranges from 300 VA to more than 1000 kVA
- Integrated systems that provide both environmental and power protection in a single, flexible package
- Monitoring and control—from systems of any size or location, on-site or remote
- Service and support through more than 100 service centers around the world and a 24/7 Customer Response Center

While every precaution has been taken to ensure the accuracy and completeness of this literature, Liebert Corporation assumes no responsibility and disclaims all liability for damages resulting from use of this information or for any errors or omissions.

© 2003 Liebert Corporation

All rights reserved throughout the world. Specifications subject to change without notice.

® Liebert and the Liebert logo are registered trademarks of Liebert Corporation. All names referred to are trademarks or registered trademarks of their respective owners.

SLI-23275 (2/03) Rev. 0

### Technical Support/Service

#### Web Site

[www.liebert.com](http://www.liebert.com)

#### Monitoring

800-222-5877

[monitoring@liebert.com](mailto:monitoring@liebert.com)

Outside the US: 614-841-6755

#### Single-Phase UPS

800-222-5877

[upstech@liebert.com](mailto:upstech@liebert.com)

Outside the US: 614-841-6755

#### Three-Phase UPS

800-543-2378

[powertech@liebert.com](mailto:powertech@liebert.com)

#### Environmental Systems

800-543-2778

#### Outside the United States

614-888-0246

#### Locations

##### United States

1050 Dearborn Drive

P.O. Box 29186

Columbus, OH 43229

##### Italy

Via Leonardo Da Vinci 8

Zona Industriale Tognana

35028 Piove Di Sacco (PD)

+39 049 9719 111

Fax: +39 049 5841 257

##### Asia

23F, Allied Kajima Bldg.

138 Gloucester Road

Wanchai

Hong Kong

+852 2 572 2201

Fax: +852 2 831 0114



**EMERSON**  
Network Power



## Free Manuals Download Website

<http://myh66.com>

<http://usermanuals.us>

<http://www.somanuals.com>

<http://www.4manuals.cc>

<http://www.manual-lib.com>

<http://www.404manual.com>

<http://www.luxmanual.com>

<http://aubethermostatmanual.com>

Golf course search by state

<http://golfingnear.com>

Email search by domain

<http://emailbydomain.com>

Auto manuals search

<http://auto.somanuals.com>

TV manuals search

<http://tv.somanuals.com>