

POWER PROTECTION



UPStation GXT™

**1800-2700 VA
208V**

USER MANUAL
English / Español



IMPORTANT SAFETY INSTRUCTIONS

WARNING: Do not attempt to service this product yourself except to replace the battery. Opening or removing the cover may expose you to dangerous voltages, even when the AC cord is disconnected from the electrical outlet. Refer all servicing to qualified service personnel.

- 1. SAVE THESE INSTRUCTIONS.** THIS MANUAL CONTAINS IMPORTANT INSTRUCTIONS THAT SHOULD BE FOLLOWED DURING INSTALLATION AND MAINTENANCE OF THE UNINTERRUPTIBLE POWER SYSTEM (UPS) AND BATTERIES.
CONSERVER CES INSTRUCTIONS. CETTE NOTICE CONTIENT DES INSTRUCTIONS IMPORTANTES CONCERNANT LA SÉCURITÉ.
- 2. This product is not intended for use with life support and other U.S. FDA designated "critical" devices. See Limited Warranty.**
- 3. CAUTION:** A BATTERY PRESENTS A RISK OF ELECTRICAL SHOCK OR BURN FROM HIGH SHORT CIRCUIT CURRENT. OBSERVE PROPER PRECAUTIONS.
ATTENTION: UNE BATTERIE PRESENT UN RESQUE DE CHOC ÉLECTRIQUE OU DE BRÛLURE PAR TRANSFERT D'ÉNERGIE. SUIVRE LES PRÉCAUTIONS QUI S'IMPOSENT.
- 4. WHEN REPLACING THE BATTERIES, USE THE SAME NUMBER AND TYPE OF BATTERIES. PROPER DISPOSAL OF BATTERIES IS REQUIRED. REFER TO YOUR LOCAL CODES FOR DISPOSAL REQUIREMENTS.**
POUR LE REMPLACEMENT, UTILISER LE MÊME NOMBRE ET TYPE DE BATTERIES. L'ÉLIMINATION DES BATTERIES EST RÉGLE-MENTÉE. CONSULTER LES CODES LOCAUX À CER EFFET.
- 5. Read all safety and operating instructions before operating the UPS. Adhere to all warnings on the unit and in this manual. Follow all operating and user instructions.**
- 6. Turn the UPS off and unplug it before cleaning. Use only a soft cloth, never liquid or aerosol cleaners.**
- 7. The UPS is designed for data processing equipment. Do not plug appliances, such as hair dryers, heaters, vacuum cleaners, or electric drills, into the UPS output receptacles.**
- 8. WARNING:** Do not modify input cable. Consult your dealer if connector does not match the utility receptacle. The UPS must be grounded at all times while in use. Turn the UPS off before unplugging it, or the safety ground will be removed. Operate UPS only from a properly grounded 208 VAC outlet (2 wire plus ground).
- 9. The UPS is equipped with a grounded NEMA L6-15 or L6-20 input power plug (depending upon model). Do not defeat the safety purpose of this plug. If unable to fully insert the plug into the wall outlet, contact a qualified electrician for assistance.**

10. Route power supply cords so they are not walked on or pinched.
11. Never block or insert any object into the ventilation holes or other openings. Maintain a clearance of four (4) inches in front and rear of the UPS for proper air flow and cooling.
12. It is not necessary to turn off the UPS before starting the battery replacement procedure. Servicing of batteries should be performed or supervised by personnel knowledgeable of batteries and the required precautions. To replace batteries, refer to the battery replacement procedure. If you feel unqualified to replace the batteries, do not open the battery door. Refer all servicing to qualified service personnel.
13. **CAUTION:** Do not open or mutilate the batteries. Released electrolyte is harmful to skin and eyes and may be toxic.

INTRODUCTION AND SYSTEM DESCRIPTION

Congratulations on your choice of the Liebert UPStation GXT™ Uninterruptible Power System (UPS). It provides conditioned power to microcomputers and other sensitive electronic equipment.

Upon generation, AC power is clean and stable. However, during transmission and distribution it may be subject to voltage sags, spikes, or complete power failure, which may interrupt computer operations, cause data loss, or even damage equipment. The UPStation GXT™ protects equipment from these disturbances.

The UPStation GXT™, 208 VAC models comes in nominal power ratings of 1800 or 2700 VA. Complete specifications appear near the end of this section.

The UPStation GXT™ is a compact, “on-line” UPS. An “on-line” UPS continuously conditions and regulates its output voltage, whether the utility power is present or not. It supplies connected equipment with clean sinewave power. Sensitive electronic equipment operates best from sinewave power.

For ease of use, the UPStation GXT™ contains a light emitting diode (LED) display to indicate either “load percentage” or “battery capacity” depending upon the mode of operation. It also provides self diagnostics, a combination On/Alarm Silence/Manual Battery Test button, a combination Off/Bypass button, and two levels of alarms when the unit is operating on battery.

The UPStation GXT™ has an interface port for communications between the UPS and a LAN server or other computer system. This port provides detailed operating information including voltages, currents, and alarm status to the host system when used in conjunction with Liebert SiteNet® software. SiteNet® software can also remotely control UPS operation.

CAUTION: This equipment has been tested and complies with limits for a Class A digital device, pursuant to Subpart B of Part 15 of FCC rules. These limits provide reasonable protection against harmful interference when the equipment is operated in a commercial environment. This equipment generates, uses, and can radiate radio frequency energy. If it is not installed and used in accordance with the instruction manual, it may cause harmful interference to radio communications. Operation of this equipment in a residential area is likely to cause harmful interference, which the user must correct at his own expense.

MAJOR COMPONENTS

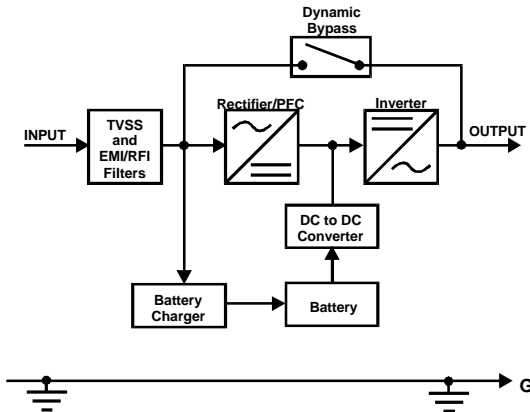

TRANSIENT VOLTAGE SURGE SUPPRESSION (TVSS) AND EMI/RFI FILTERS

These UPS components provide surge protection, and filter both electromagnetic interference (EMI) and radio frequency interference (RFI). They minimize any surges or interference present in the utility line and keep the sensitive equipment protected.

RECTIFIER/POWER FACTOR CORRECTION (PFC) CIRCUIT

In normal operation, the rectifier/power factor correction (PFC) circuit converts utility AC power to regulated DC power for use by the inverter, while ensuring that the waveshape of the input current used by the UPS is near ideal. Extracting this sinewave input current achieves two objectives: the utility power is used as efficiently as possible by the UPS, and the amount of distortion reflected on the utility is reduced. This results in cleaner power being available to other devices in the building not being protected by the UPStation GXT™.

INVERTER

In normal operation, the inverter utilizes the DC output of the power factor correction circuit and “inverts” it into precise, regulated sinewave AC power. Upon a utility power failure, the inverter receives its required energy from the battery through the DC-DC converter. In both modes of the operation, the UPS inverter is on-line and continuously generating clean, precise, regulated AC output power.

BATTERY CHARGER

The battery charger utilizes energy from the utility power and precisely regulates it to continuously “float” charge the battery system. The battery system charges whenever the UPStation GXT™ is plugged in.

DC TO DC CONVERTER

The DC-DC converter utilizes energy from the battery system and raises the DC voltage to the optimum operating voltage for the inverter. This allows the inverter to operate continuously at its optimum efficiency and voltage, thus increasing reliability.

BATTERY

The UPStation GXT™ employs valve regulated, nonspillable, lead acid batteries. At typical room temperatures and with the UPS float charging, the battery system will last many years. Optional external battery cabinets are available to provide extended run times. For battery run times, refer to the Typical Battery Discharge Curves.

DYNAMIC BYPASS

The UPStation GXT™ provides an alternate path for utility power to the connected load, in the unlikely event of a UPS malfunction. Should the UPS have an overload, over temperature, or UPS failure condition, the UPS automatically transfers the connected load to bypass. Bypass operation is indicated by an alarm and an illuminated Bypass LED (other LED's may be illuminated to indicate the diagnosed problem). To manually transfer the connected load from the inverter to bypass power, press the Off button once.

NOTE: The bypass power path does NOT protect the connected equipment from disturbances on the utility supply.

GENERAL INSTALLATION

TOWER UPS INSTALLATIONS

1. Unpack the UPS carefully noting the packing method. Retain the box and packing material for possible future shipment.
2. **CAUTION:** The UPS is heavy (see specifications). Take proper precautions when lifting or moving it.
3. Visually inspect the UPS for freight damage. Report damage to the carrier and your dealer.
4. Ensuring load equipment is turned off, plug all loads into the UPS output receptacles.
5. Plug the UPS into a dedicated wall receptacle properly protected by a circuit breaker or fuse in accordance with the National And Local Codes. Use a 15 amp rated device for the 1800 VA units, and a 20 amp device for the 2700 VA unit. The wall receptacle must be grounded.
6. Locate the UPS indoors in a controlled environment, where it cannot be accidentally disconnected. Locate it in an area with unrestricted air flow, away from water, flammable liquids, gases, corrosives, or conductive contaminants. Maintain a minimum of 4 inches (100 mm) clearance in front and rear of the UPS. Maintain an ambient temperature range of 32° to 104°

NOTE: UPS operation in temperatures above 77° F (25° C) reduces battery life.

7. Turn on the UPS by pressing the On button for at least one half second; then turn on the connected load equipment. The UPS is ready for normal operation.

Support Base

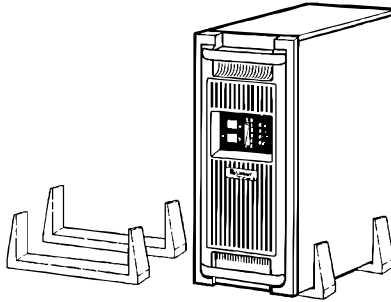

Rack-Tower models are stabilized by the supplied support bases. See illustration for placement.

RACK-MOUNT CONVERSION DIAGRAMS

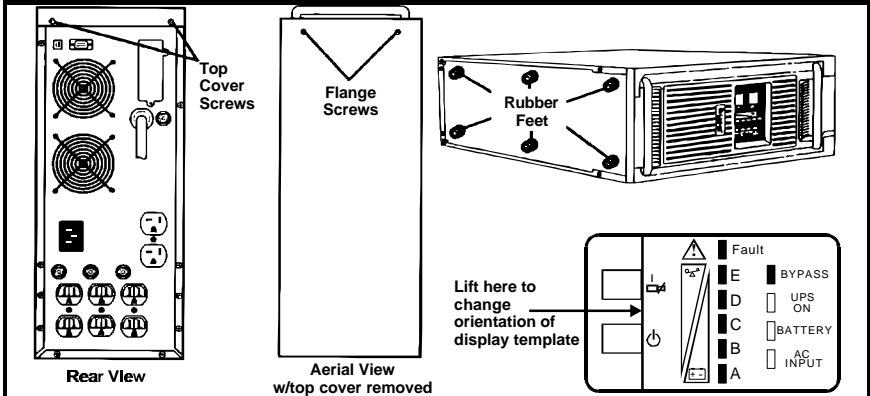

RACK-MOUNT UPS CONVERSION AND INSTALLATION

1. Unpack the UPS carefully noting the packing method. Retain the box and packing material for possible future shipment.
2. **CAUTION:** The UPS is heavy (see specifications). Take proper precautions when lifting or moving it.
3. Visually inspect the UPS for freight damage. Report damage to the carrier and your dealer.
4. Remove the two screws located at the rear of the top cover with a Phillips (cross head) screw driver. Push the top cover towards back of UPS and lift off. Remove and retain the two flange screws located at the front of UPS.

5. Gently lay unit on its right side and remove the six rubber feet with the screw driver. Remove and retain screws from the two front feet.
NOTE: The rubber feet are not used for rack-mount installations.
6. Locate securing flanges in the top of packing material and fasten to the UPS using the flange screws from steps 4 and 5.
7. Remove display template to change the orientation of the display. You may also rotate the "Liebert UPStation GXT™" plate located at left of display area.
8. **NOTE:** UPS unit **MUST** be supported by a shelf, brackets or slide rails on each side. The securing flanges **WILL NOT** support the weight of the UPS.
9. For slide rail installations, securing hardware is provided with the UPS and is located in the packing material (slide rails sold separately). Fasten the slides into position with the screws per the instructions included with the slide rails.
10. The UPS is now ready to be placed into the equipment rack.
11. Ensure the load equipment is turned off, plug all loads into the UPS output receptacles.
12. Plug the UPS into a dedicated wall receptacle properly protected by a circuit breaker or fuse in accordance with the National And Local Codes. Use a 15 amp rated device for the 1800 VA units, and a 20 amp device for the 2700 VA unit. The wall receptacle must be grounded.
13. Locate UPS indoors in a controlled environment, where it cannot be accidentally turned off. Locate it in an area of unrestricted air flow around the unit, away from water, flammable liquids, gases, corrosives, or conductive contaminants. Maintain a minimum of 4 inches (100 mm) clearance in front and rear of the UPS. Maintain an ambient temperature range of 32° to 104° F (0° to 40° C).
NOTE: UPS operation in temperatures above 77° F (25° C) reduces battery life.
14. Turn on the UPS by pressing the On button; then turn on the connected load equipment. The UPS is ready for normal operation.

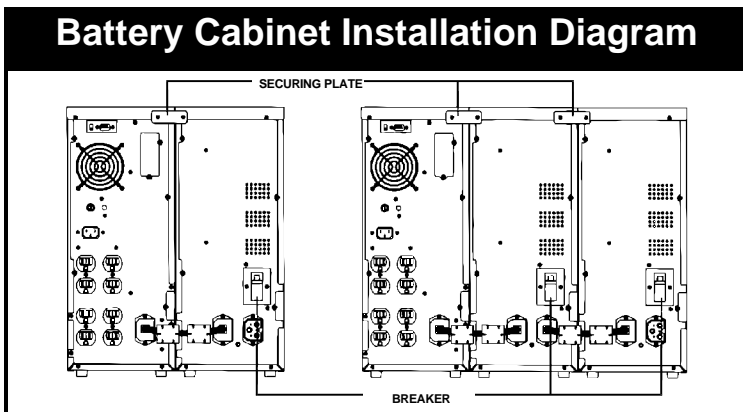

OPTIONAL BATTERY CABINET(S) INSTALLATION

Up to two optional battery cabinets may be connected to the UPS to provide additional run time. Battery cabinets are designed to be placed on either side or beneath the UPS.

Unpack the UPS battery cabinet(s) carefully noting the packing method. Retain the box and packing material for possible future shipment.

1. **CAUTION:** The battery cabinet(s) are heavy. Take proper precautions when lifting or moving them.
2. Visually inspect the UPS for freight damage. Report damage to the carrier and your dealer.
3. Follow the same installation instructions used earlier for the UPS (tower or rack-mount).
4. Attach external battery cabinet as shown, using the enclosed metal securing plate to prevent tip-over.
5. Connect the supplied cable to the battery cabinet then to the UPS.
6. Turn on the breaker on the rear of the battery cabinet.

FERRITE BEAD INSTALLATION

Serial Communications

Attach the smaller enclosed ferrite bead clamp to the communication cable as shown in the drawing using the following directions:

- Open the ferrite bead.
- Place the communication cable inside the ferrite bead groove.
- Position the ferrite bead as close as possible to the end of the cable that connects to the DB9 connector of the UPS.
- Close the ferrite bead so that the ferrite bead's case snaps closed with the cable routed inside the ferrite bead's case.

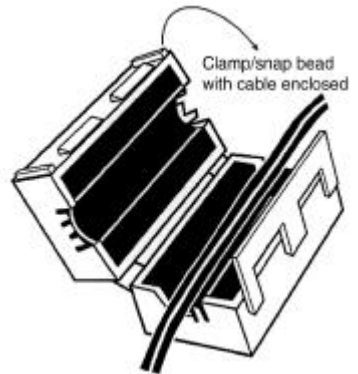

SNMP Installation

Attach the larger enclosed ferrite bead clamp to the network cable as shown in the drawing using the following directions:

- Open the ferrite bead.
- Place the network cable inside the ferrite bead groove.
- Wrap the cable once around the bead.
- Position the ferrite cable as close as possible to the end of the cable that connects to the UPS.
- Close the ferrite bead so that the ferrite bead's case snaps closed with the cable routed inside the ferrite bead's case.

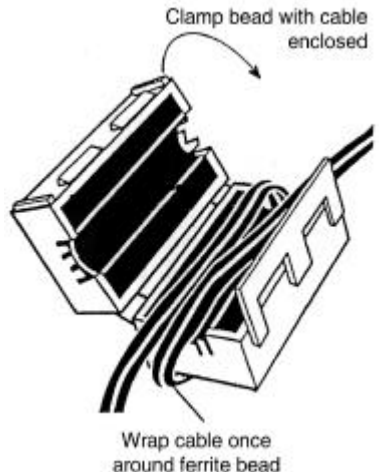

UPStation GXT™

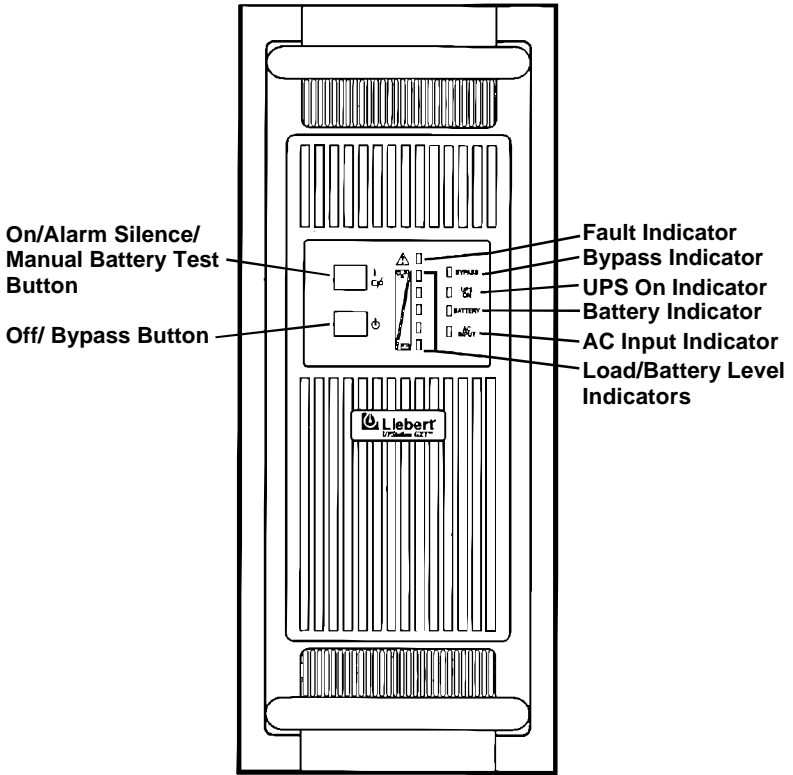

- 1- Output Receptacles
- 2- DB-9 Interface Port
- 3- AC Inlet
- 4- Intellislot™
Communications Port
- 5- Circuit Protector or fuse
- 6- Output Voltage Selector
Switches
- 7- Battery Cable Connector

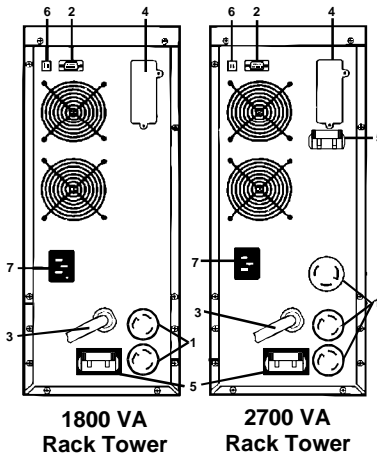

CONTROLS AND INDICATORS

On/Alarm Silence/Manual Battery Test Button

This button controls output power to connected load(s) and has three functions: On, Alarm Silence, and Manual Battery Test. Pressing this button will start up the UPS in order to provide conditioned and protected power into the utility socket.

To silence alarms, press this button for at least one half second while alarm conditions are present. After the alarm is silenced, the UPStation GXT™ will reactivate the alarm system to alert of additional problems.

Note: The low battery and bypass reminder alarms cannot be silenced.

To initiate a manual battery test, press this button for at least one half second while operating from utility power and no alarm conditions are present.

If the bottom two LEDs do not illuminate during a Battery Test, allow the UPS to recharge the batteries for 24 hours. After 24 hours, retest the batteries. If the batteries have been retested and the bottom two LEDs still do not illuminate, contact your dealer or Liebert Technical Support (LTS) for a battery replacement kit.

Off/Bypass Button

This button controls output power to connected load(s) and has dual functions: Off and Bypass.

CAUTION: Pressing this button once will cause the load to be transferred to bypass power. Pressing this button a second time within 4 seconds will result in loss of power to the output sockets and connected loads. Perform all necessary shutdown procedures on connected loads before pressing this button twice.

Load/Battery Level Indicators (4 Green, 1 Amber)

The Load/Battery Level indicators have dual functions. During normal mode operation LED indicators display the approximate electrical load placed upon the UPS; and during battery mode operation LED indicators display approximate battery capacity. Refer to the Typical Battery Discharge Curves to determine the approximate amount of back up time with respect to your connected load percentage.

The UPStation GXT™ is equipped with automatic and remote battery test features. The automatic test occurs every 14 days if utility has not been interrupted (14 day timer resets if unit goes to battery). Should the battery fail this test, the fault indicator along with the A and C diagnostic LEDs will illuminate and an alarm will sound (refer to Troubleshooting Guide). The remote test feature functions with either SiteNet® 2 or SiteNet® SNMP Manager software and can remotely initiate the battery test.

Fault Indicator (Red)

The Fault indicator is illuminated if the UPS has detected a problem. Also, one or more of the load/battery level indicators may be illuminated (refer to Troubleshooting Guide).

Bypass Indicator (Amber)

The Bypass indicator is illuminated when the UPS is operating from bypass power. An alarm will sound indicating the UPS detected a problem, or the manual bypass function has been activated.

UPS On Indicator (Green)

The UPS On indicator is illuminated when the UPS inverter is operating and supplying power to your connected loads.

Battery Indicator (Amber)

The Battery indicator is illuminated when the UPS is operating from the battery system.

AC Input Indicator (Green)

The AC Input indicator is illuminated when utility power is available and within the input specification.

Output Voltage Selector Switches

The Output Voltage Selector Switches, located on the rear of the UPS, are designed to allow selecting or changing the desired output voltage to match the utility. The settings to choose from are 208, 220, 230, and 240 VAC output. The factory default setting is 208 VAC.

NOTE: Never change the switch settings while UPS is on and powering connected loads.

Switch positions for voltages:

208 VAC

220 VAC

own

230 VAC

240 VAC

NOTE: Setting output voltage to any other voltage than 208 VAC will automatically increase the 1800 VA UPS VA and Watt rating to 2000 VA/1400W and the 2700 VA UPS VA and Watt rating to 3000 VA/2100W.

OPERATION

NORMAL MODE OPERATION

During normal operation, utility power provides energy to the UPS. The filters, the power factor conditioning circuit and the inverter process this power to provide computer grade power to connected loads. The UPS maintains the batteries in a fully charged state.

The four green LEDs indicate an approximate level of load in 25% increments. If the UPS becomes loaded beyond full rating, the fifth (amber) LED indicator will illuminate and sound an alarm.

The display template indicates the percentage of load on the UPS output. Figure 1 displays approximately 51-75% loading.

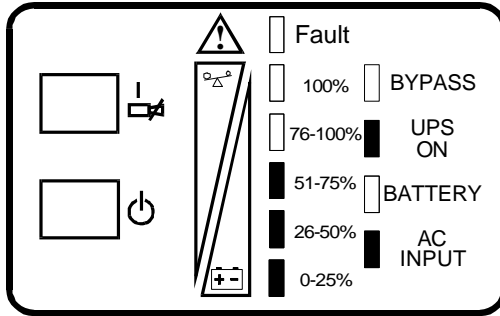

Figure 1- Normal Mode Operation at 51-75% loading

BATTERY MODE OPERATION

Battery mode occurs in event of an extreme input voltage condition or complete utility failure. The battery system supplies power through the DC-DC converter to the inverter to generate power for the connected load.

During battery mode an alarm sounds every 10 seconds. This will change to 2 beeps every 5 seconds when battery runs low (approximately 2 minutes remaining). The AC Input LED will extinguish, and the Battery LED will illuminate to warn that a utility problem has occurred. Each load/battery level indicator represents a 20% capacity level. As capacity decreases, fewer indicators remain illuminated. Refer to the Troubleshooting Guide.

For battery run times, refer to the Typical Battery Discharge Curves. To increase this time, turn off non-essential pieces of equipment (such as idle computers and monitors) or add the optional external battery cabinet.

CAUTION: Turning off the UPS while in battery mode will result in loss of output power.

Figure 2 displays approximately 61-80% battery capacity remaining.

BATTERY RECHARGE MODE

Once utility power is restored, the UPS resumes normal operation. At this time, the Battery Charger begins recharging the battery.

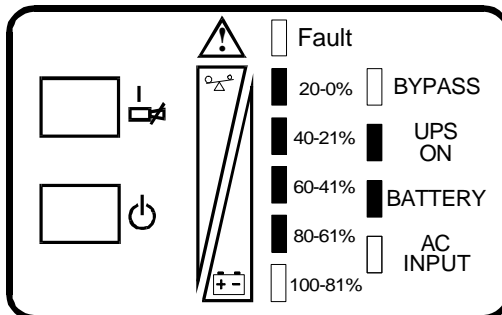

Figure 2 – Battery Mode Operation at 61-80% battery capacity

COMMUNICATIONS INTERFACE PORT

The UPStation GXT™ UPS contains a standard DB-9 female connector located on the rear of the UPS unit. Several signals are provided on this port and are assigned as follows:

| PIN | ASSIGNMENT DESCRIPTION |
|-----|--|
| 1 | Low Battery (open collector) |
| 2 | UPS TxD (typical RS-232 levels) |
| 3 | UPS RxD (typical RS-232 levels) |
| 4 | Remote Shutdown (5-12V); battery operation |
| 5 | Common |
| 6 | Remote Shutdown (short to pin 5); all modes of operation |
| 7 | Low Battery (open emitter) |
| 8 | Utility Fail (open emitter) |
| 9 | Utility Fail (open collector) |

PIN ASSIGNMENT

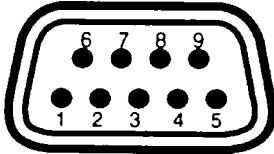

COLLECTOR TO EMITER*

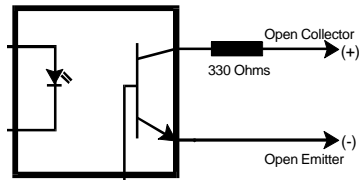

*Maximum voltage and current on pins 1,7,8,9 is 80V DC; 10.0 mA.

UPS MONITORING

The UPStation GXT™ UPS has the capability of being monitored with stand alone computers, network workstations, network servers, or UNIX hosts via the DB-9 female connector located on the rear of the UPS.

This capability is used in applications requiring the UPS to provide status and power monitoring information to the computer system. For example, during a utility power failure, the information can be used by the computer's operating system or application program to automatically save information in buffers, to close files, and shut down operations prior to battery capacity depletion.

Monitoring of the UPS via a computer system is easily made with a Liebert SiteNet® 1 shutdown kit (sold separately). Consult your local Liebert representative to determine the correct software kit for your application. The kit includes special purpose cable and shutdown software.

UPS INTELLIGENT COMMUNICATIONS

The UPStation GXT™ UPS has the capability to communicate intelligently with stand alone computers, network workstations, network servers, or UNIX hosts via the DB-9 female connector located at the rear of the UPS. By purchasing the optional Liebert SiteNet® 2 software package (sold separately), intelligent communications allows the following capabilities:

- Quantitative monitoring of utility and UPS power
- Quantitative monitoring of internal UPS parameters
- Periodic tests of battery quality and replacement notification
- Timed and delayed shutdown of the UPS
- Logging of power disturbances and anomalies

Consult your local Liebert sales representative for more information about SiteNet® 2 software.

UPS INTELLISLOT™ COMMUNICATIONS

The UPStation GXT™ UPS contains an Intellislot™ communications port for the optional internal Ethernet SNMP card. Optional SiteNet® SNMP Manager software is available to allow communication through several network management systems. Contact your local Liebert representative, dealer, or reseller.

CAUTION: TO MAINTAIN SAFETY (SELV) BARRIERS AND FOR ELECTROMAGNETIC COMPATABILITY, SIGNAL CABLES SHOULD BE SEGREGATED AND RUN SEPARATE FROM ALL OTHER POWER CABLES, WHERE APPLICABLE.

MAINTENANCE

The UPStation GXT™ UPS requires very little maintenance. The batteries are valve regulated, nonspillable, lead acid, and should be kept charged to obtain their designed life. The UPS continuously charges the batteries when connected to the utility supply.

When storing the UPS for any length of time, it is recommended to plug the UPS in for at least 24 hours every four to six months to ensure full recharge of the batteries.

The UPStation GXT™ UPS is designed to allow the user to safely replace the batteries. Read the safety cautions before proceeding. Contact your dealer to obtain the appropriate replacement battery kit.

BATTERY REPLACEMENT PROCEDURES

CAUTION – A battery can present a risk of electrical shock and high short circuit current. The following precautions should be observed before replacing the batteries:

- It is not necessary to turn off and disconnect the UPS from the utility power prior to opening the battery replacement door; however, it is your option. The UPStation GXT batteries can be replaced without turning off the UPS or your connected equipment.
- Remove rings, watches, and other metal objects.
- Use a Phillips (cross head) screwdriver with insulated grips.
- Do not lay tools or other metal objects on top of the batteries.
- If the battery replacement kit is damaged in any way or shows signs of leakage, contact your dealer immediately.
- Do not dispose of batteries in a fire, the batteries may explode.
- If you feel unqualified to replace the batteries, do not open the battery door. Call Liebert Technical Support (LTS). World Wide Technical Support numbers are located at the end of this section.

FOR 1800 TO 2700 VA RACK/TOWER MODELS:

CAUTION: The battery assembly is heavy (approximately 55 lbs (25 kg)). Take proper precautions when lifting or moving it.

TOWER MODELS ONLY:

- Remove top cover by removing the two screws located on rear of top cover. Push the top cover towards the back of UPS and lift off. Remove the two flange screws near the front of UPS.
- Gently lay the UPS on its right side and remove the two front rubber feet. Continue with Rack/Tower Models battery replacement procedures.

RACK & TOWER MODELS:

1. Grasp the front bezel (plastic cover) and pull forward for removal.
NOTE: The two securing flanges must be removed before front bezel (cover) can be removed.
2. Remove the two screws from the small battery door. Remove the door by pulling it forward and lifting it off. Lay aside for reassembly.
NOTE: The small door contains a connector that disconnects battery into a lower, safer voltage.
3. Loosen the five screws of the large battery door. Remove the door by pulling it forward and lifting it off. Lay aside for reassembly.
4. Pull battery assembly out approximately 50mm (2 in). Gently pull the battery wiring out and disconnect the battery connector.
5. Completely remove battery assembly from the UPS.
6. Unpack the new battery assembly taking care not to destroy the packing. Compare new and old battery assemblies to make sure they are the same quantity and voltage rating (see specifications). If so, proceed with the next step; otherwise STOP and contact your dealer or LTS.
7. Slide the new battery assembly into the cavity, leaving 50mm (2 in).

8. Connect the battery wire connectors together.
9. Slide battery assembly completely into the UPS, reposition the large battery door and replace the screws removed in step 3.
10. Reposition small battery door and replace the screws removed in step 2 to lock top battery door closed.
11. Replace front bezel (cover) on UPS. Replace the securing flanges (for Rack Tower procedures) and flange screws to secure bezel in place. For Tower procedures, replace the two front rubber feet, stand unit upright, and replace the top cover. Connect the UPS to the utility supply socket and turn on the UPS by pressing the On button. The UPS is ready for normal operation.
12. Dispose of batteries in accordance with your local laws and regulation.

RACK / TOWER BATTERY REPLACEMENT

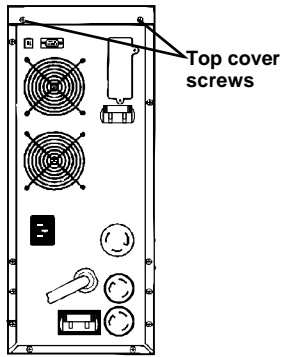

Rear View

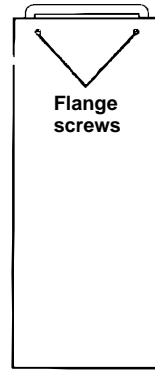

Aerial View
w/top cover removed

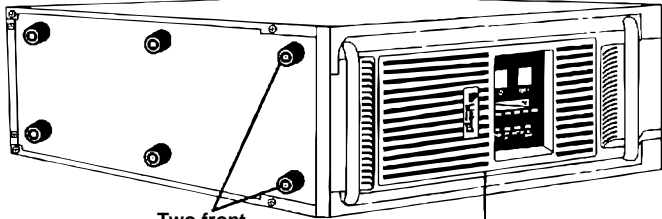

Two front
rubber feet

Front bezel (cover)

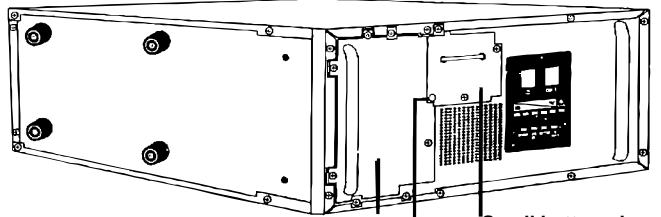

Large battery
door

Small battery door

Screw hidden by
small battery door

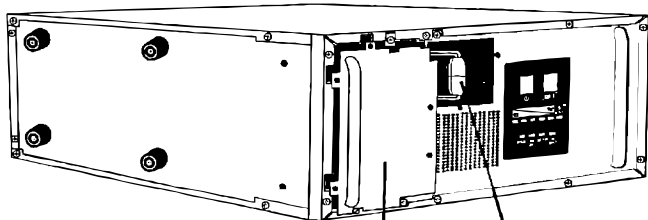

Large battery door

Battery connector

UPStation GXT™ BATTERY RUN TIMES

(Discharge times are at 25° C ambient)

1800 VA Rack Tower

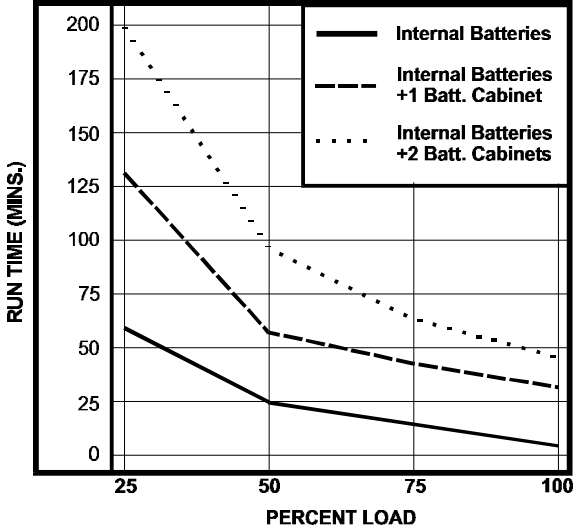

2700 VA Rack Tower

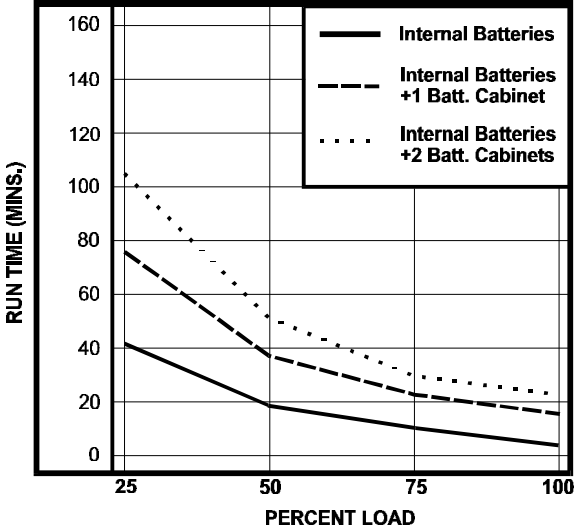

AUDIBLE ALARM CONDITIONS

| CONDITION | ALARM |
|---------------------------------------|---|
| Battery mode (utility failure) | One short beep every ten seconds; more than two minutes of run time remaining |
| Low battery | Two short beeps every five seconds; less than two minutes of run time remaining |
| Output overload (bypass) | One short beep every half second |
| Over temperature (bypass) | One second beep every four seconds |
| DC Bus overvoltage (bypass) | One second beep every four seconds |
| Control power supply failure (bypass) | One second beep every four seconds |
| PFC failure (bypass) | One second beep every four seconds |
| Inverter failure | One second beep every four seconds |
| Battery Test failure | Two second beep every minute |

TROUBLESHOOTING

The information below indicates various symptoms a user may encounter in the event the UPStation GXT™ develops a problem. Use this information to determine whether external factors cause the problem and how to remedy the situation.

1. The fault indicator will illuminate indicating the UPS detected a problem.
2. An alarm will sound, alerting that the UPS requires attention.
3. One or more additional load/battery level LED indicators will be illuminated to provide a diagnostic aid to the operator, as described below:

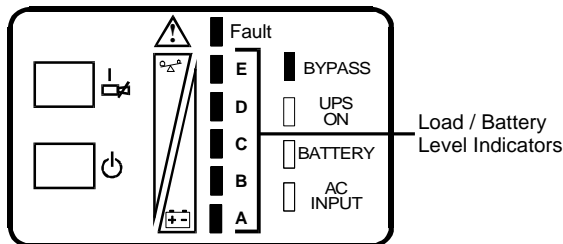

- All.** On bypass due to output overload (beep every half second)
- A.** On bypass due to over temperature condition (beep every 4 seconds)
- B.** On bypass due to DC bus overvoltage (beep every 4 seconds)
- C.** On bypass due to control power supply failure (beep every 4 seconds)
- D.** On bypass due to PFC failure (beep every 4 seconds)
- E.** On bypass due to inverter failure (beep every 4 seconds)
- A&C.** UPS failed battery test (long beep every minute)
- C&E.** UPS shutdown due to command from communication port (SNMP); no beep

The fault indicators will be illuminated indefinitely while battery charger is operational, or for a maximum of 5 minutes while battery charger is not operational.

If a problem persists consult your dealer, or contact Liebert Technical Support (LTS). World Wide Technical Support numbers are located at the end of this section.

TROUBLESHOOTING GUIDE

| PROBLEM | CAUSE | SOLUTION |
|--|--|--|
| UPS fails to start when on button is pressed | UPS is short circuited or overloaded | Ensure UPS is off. Disconnect all loads and ensure nothing is lodged in output sockets. Ensure loads are not defective or shorted internally. |
| | Internal fuse is blown, indicating internal fault | Do not attempt to open or service the UPS. Contact your dealer or LTS. |
| Battery indicator is illuminated | UPS not plugged in | UPS is operating from battery mode, make certain UPS is securely plugged into the wall socket and feeder breaker in "on". |
| | UPS input protection has opened | UPS is operating from battery mode. Save data and close applications. Reset input breaker. |
| | Utility voltage out of UPS input range. | UPS is operating from battery mode. Save data and close applications. Ensure utility supply voltage is within acceptable limits for UPS. |
| UPS has reduced battery time | Batteries not fully charged | Keep UPS plugged in continuously at least 24 hours to recharge batteries |
| | UPS is overloaded | Check load level display and reduce load level |
| | Batteries may not be able to hold a full charge due to age | Replace batteries. Contact your dealer or LTS for replacement battery kit |
| Fault and Bypass indicators and all load level LEDs are illuminated | UPS overloaded or load equipment is faulty | Check load level display and remove non-essential loads. Recalculate load VA and reduce number of loads connected to UPS. Check load equipment for faults. |
| Fault and Bypass indicators and diagnostic LED A are illuminated | UPS internal fan has a problem or UPS shutdown due to temperature condition. Load is on bypass power | Ensure UPS is not overloaded, ventilation openings not blocked, or room ambient temperature not excessive. Wait 30 minutes to allow UPS to cool, then restart UPS. If it does not restart, contact your dealer or LTS. |
| Fault and Bypass indicators and diagnostic LED B are illuminated | UPS internal DC bus overvoltage | UPS requires service. Contact your dealer or LTS. |
| Fault and Bypass indicators and diagnostic LED C are illuminated | UPS power control fault. | UPS requires service. Contact your dealer or LTS. |
| Fault and Bypass indicators and diagnostic LED D are illuminated | UPS PFC fault. | UPS requires service. Contact your dealer or LTS. |
| Fault and Bypass indicators and diagnostic LED E are illuminated | UPS inverter fault. | UPS requires service. Contact your dealer or LTS. |
| Fault and Bypass indicators and diagnostic LED A & C are illuminated | UPS failed the battery test. | Replace batteries. Contact your dealer or LTS. |
| Fault and Bypass indicators and diagnostic LED C & E are illuminated | UPS shutdown due to a command from the communications port(s) | Your UPS has received a signal or command from the attached computer. If this was inadvertent, ensure the communication cable used is correct for your system. For assistance, contact your dealer or LTS. |

SPECIFICATIONS

| MODEL NUMBER | GXT1800RT-208 | GXT2700RT-208 | GXT96VBATT |
|-----------------------------|--|---|---|
| MODEL RATING VA/W | 1800 / 1290 | 2700 / 1890 | |
| DIMENSIONS: in (mm) | | | |
| Unit | 7.0 x 19.3 x 16.9 (177 x 522 x 430) | 7.0 x 19.3 x 16.9 (177 x 522 x 430) | 7.0 x 19.3 x 16.9 (177 x 522 x 430) |
| Shipping W x D x H | 13.38 x 26.0 x 22.25 (340 x 660 x 565) | 13.38 x 26.0 x 22.25 (340 x 660 x 565) | 13.38 x 26.0 x 22.25 (340 x 660 x 565) |
| WEIGHT: lbs (kg) | | | |
| Unit | 80.9 (36.8) | 85.9 (39.0) | 71.6 (32.5) |
| Shipping | 88.0 (40.0) | 93.0 (42.3) | 78.7 (35.8) |
| INPUT AC PARAMETERS | | | |
| Voltage Range (typical) | 208 VAC nominal; variable based upon output load | | |
| 100% - 90% Loading | 191 VAC to 275 VAC | | |
| 90% - 70% Loading | 164 VAC to 275 VAC | | |
| 70% - 30% Loading | 144 VAC to 275VAC | | |
| 30% - 0% Loading | 124 VAC to 275VAC | | |
| Frequency | 48 – 52 Hz or 58 – 62 Hz; auto sensing | | |
| Input Power Cord | 6 ft. attached, w/ NEMA L6-15 plug | 6 ft. attached, w/ NEMA L6-20 plug | N/A |
| OUTPUT AC PARAMETERS | | | |
| Output Receptacles | (2) NEMA L6-15R | (2) NEMA L6-15R, (1) NEMA L6-20R | N/A |
| Voltage | 208/220/230/240 (switch selectable) VAC; ±3% | | |
| Frequency | 50 Hz or 60Hz | | |
| Waveform | Sinewave | | |
| Main Mode Overload | 200% for 8 cycles; 130% for 10 seconds with transfer to bypass | | |
| BATTERY PARAMETERS | | | |
| Type | Valve-regulated, nonspillable, lead acid | | |
| Qty. x Voltage x Rating | 8 x 12V x 7 or 7.2 AH | 8 x 12V x 7 or 7.2 AH | 8 x 12V x 7 or 7.2 AH |
| Batt. Mfg./ Part # | CSB GP1270F2 or Panasonic LC-R127R2CH1 | | |
| Back-up Time | See Typical Battery Discharge Curves | | |
| Recharge Time | 5 Hours to 95% capacity after full discharge into 100% load | | Adds 5 hours per additional battery cabinet |
| ENVIROMENTAL | | | |
| Operating Temperature | +32° F to +104° F (0° C to +40° C) | | |
| Storage Temperature | +5° F to +122° F (-15° C to +50° C) | | |
| Relative Humidity | 0% to 95%, non-condensing | | |
| Operating Elevation | Up to 10,000 ft. (3000 m) at 40° C without derating | | |
| Storage Elevation | 50,000 ft. (15,000 m) maximum | | |
| Audible Noise | <45 dBA, at 1 meter | | |
| AGENCY | | | |
| Safety | UL 1778, c-UL Listed | | |
| RFI/EMI | FCC Part 15, Subpart B, Class A | | |
| Immunity | IEEE 587 Category A | | |

LIMITED WARRANTY

Liebert Corporation extends the following LIMITED WARRANTY to the purchaser and to its customer (collectively referred to as the "Purchaser"): the enclosed Uninterruptible Power System (UPS) and components are free from defects in materials and workmanship under normal use, service, and maintenance FOR A PERIOD OF TWO YEARS FROM THE DATE OF ORIGINAL PURCHASE from Liebert or the Liebert dealer or retailer. THE FOREGOING WARRANTY IS THE ONLY WARRANTY GIVEN AND NO OTHER WARRANTY IS PROVIDED, EXPRESS OR IMPLIED, INCLUDING WITHOUT LIMITATION, MERCHANTABILITY OR FITNESS FOR A PARTICULAR PURPOSE. Certain aspects of disclaimers are not applicable to consumer products acquired by individuals and used for personal, family, or household purposes (as distinguished from industrial or other purposes). Local laws may not allow limitations on how long an implied warranty lasts, so the above limitation may not apply to you. This warranty gives you specific legal rights, and you may have other rights which vary according to local law.

Certain repairs or services are the responsibility of the Purchaser and the Purchaser is expected to pay for them. This warranty does not extend either to products with removed or altered serial numbers or to any losses or damages due to act of God or source external to the product, misuse, accident, abuse, neglect, negligence, unauthorized modification, alteration, or repair, use beyond rated capacity, or improper installation, maintenance, application or use, including, without limitation, use in a manner contrary to the accompanying instructions or applicable codes. **WARNING:** Warranty is void if the battery is allowed to discharge below the minimum battery cutoff point. To prevent such discharge DO NOT leave the unit power switch "ON" for more than two (2) days without AC power being supplied to the UPS. The battery must be recharged every four (4) to six (6) months when not in use.

If the UPS fails to conform with the above warranty within the two year warranty period, Liebert will repair or replace the UPS, at Liebert's option. Repairs or replacements are warranted for the remainder of the original warranty period. Purchaser, to make a warranty claim, should call 1-800-222-5877 to obtain a Returned Goods Authorization number and shipping instructions. Return transportation costs to Liebert are the responsibility of the Purchaser.

This product is not recommended, and the Company will not knowingly sell this product, for use with life support and other designated "critical" devices. ANY SUCH USE BY A USER AUTOMATICALLY VOIDS AND DISCLAIMS ANY AND ALL WARRANTIES, INCLUDING ANY IMPLIED WARRANTY OF MERCHANTABILITY, IMPLIED WARRANTY OF FITNESS FOR A PARTICULAR PURPOSE, AND EXPRESS WARRANTIES THAT THIS PRODUCT WILL CONFORM TO ANY AFFIRMATION OR PROMISE, FOR THIS PRODUCT AND THE USER AGREES THAT IN NO EVENT SHALL THE COMPANY BE LIABLE FOR CONSEQUENTIAL OR INDIRECT DAMAGES.



1050 Dearborn Drive Columbus, OH 43229 614-888-0246

UPStation GXT™

**1800-2700 VA
208 V**

Technical Support

| | |
|----------------------------|---|
| U.S.A. | 1-800-222-5877 |
| Outside the U.S.A. | 614-841-6755 |
| U.K. | +44 (0) 1793 553355 |
| France | +33 1 4 87 51 52 |
| Germany | +49 89 99 19 220 |
| Italy | +39 2 98250 1 |
| Netherlands | +00 31 475 503333 |
| E-mail | upstech@liebert.com |
| Web site | http://www.liebert.com |
| Worldwide FAX tech support | 614-841-5471 |

The Company Behind The Products

With more than 500,000 installations around the globe, Liebert is the world leader in computer protection systems. Since its founding in 1965, Liebert has developed a complete range of support and protection systems for sensitive electronics:

- Environmental systems: close-control air conditioning from 1.5 to 60 tons.
- Power conditioning and UPS with power ranges from 250 VA to more than 1000 kVA.
- Integrated systems that provide both environmental and power protection in a single, flexible package.
- Monitoring and control — on-site or remote — from systems of any size or location.
- Service and support, through more than 100 service centers around the world, and a 24-hour Customer Response Center.

While every precaution has been taken to ensure Corporation assumes no responsibility, and disclaims all liability for damages resulting from use of this information or for any errors or omissions.

©1998 Liebert Corporation All rights reserved throughout the world. Specifications subject to change without notice.

© Liebert and the Liebert logo are registered trademarks of Liebert Corporation. All names referred to are trademarks or registered trademarks of their respective owners.

SL-23133 (1/98) Rev. N

Free Manuals Download Website

<http://myh66.com>

<http://usermanuals.us>

<http://www.somanuals.com>

<http://www.4manuals.cc>

<http://www.manual-lib.com>

<http://www.404manual.com>

<http://www.luxmanual.com>

<http://aubethermostatmanual.com>

Golf course search by state

<http://golfingnear.com>

Email search by domain

<http://emailbydomain.com>

Auto manuals search

<http://auto.somanuals.com>

TV manuals search

<http://tv.somanuals.com>