

Operating instructions

for NoFrost freezer

GB

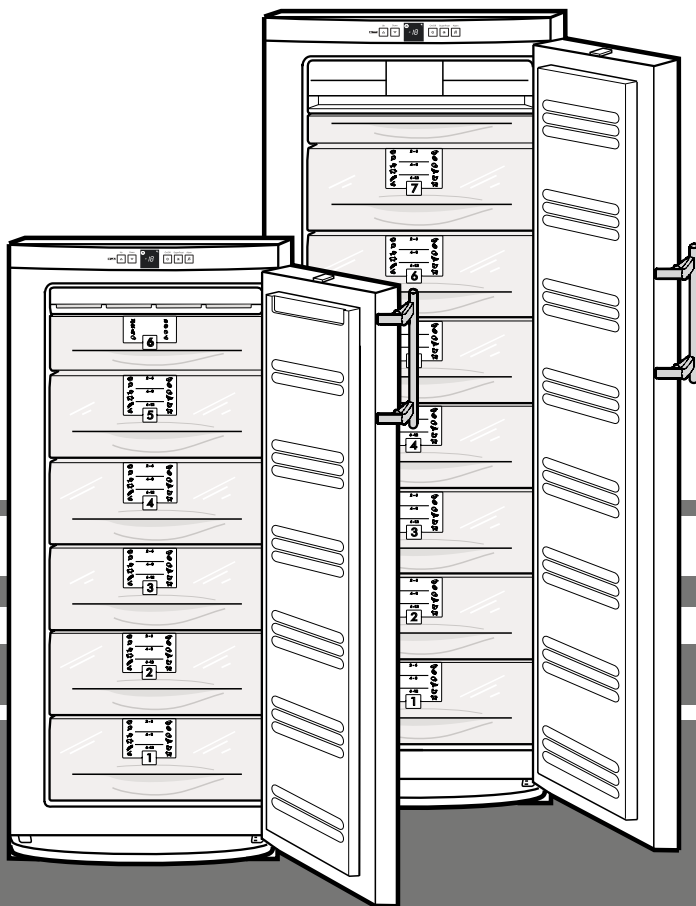

7082 300-03

GN/SGN/es..6 4905

LIEBHERR

The appliance at a glance

Operating and control elements, fig. A1

- ① Temperature display and setting display with nA FrostControl and power failure display with call-up function for highest temperature
- ② Temperature buttons:
UP = higher,
DOWN = lower,
recommended setting: -18 °C
- ③ On/off button
- ④ SuperFrost button, lit = function activated
For fast freezing of large quantities of fresh food.
 - Press the SuperFrost button ④ briefly so that it lights up.
 - The freezer will take approx. 6 - 24 hours to reach its lowest temperature.
 - Place the fresh food in the top drawers. The SuperFrost function is switched off **as required**. The freezer will switch back automatically to normal operation.
- ⑤ Audible warning on/off button
- ⑥ Child-proof lock display, lit = function activated, prevents the appliance from being switched off accidentally. See 'Additional functions' for more information.

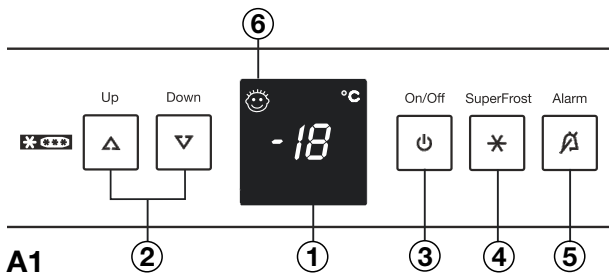

Type/Data plate, fig. A2

- ① Type designation
- ② Service number
- ③ Appliance number
- ④ Freezing capacity in kg/24 hours

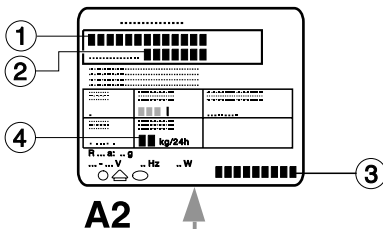

Description of appliance and equipment fig. A

- Rear transport grips
- Operating and control elements
- Lighting*
- NoFrost device for automatic defrosting
- Freezer tray*, cold-storage accumulator*
- Type/Data plate
- Drawers with information system*
- VarioSpace thanks to removable intervening shelves*
- Ice-cube tray*
- Adjustable-height feet, front transport grips, transport castors at back

* Depending on model and options

Congratulations on your purchase. In choosing this appliance you have opted for all the benefits of state-of-the-art refrigeration technology, guaranteeing you top quality, a long life span and excellent reliability.

The features on your appliance have been designed to ensure maximum convenience - day in, day out. This appliance has been manufactured with recyclable materials using an environmentally friendly process, so together you and we are making an active contribution to the preservation of our environment.

To get to know all the benefits of your new appliance, please read the information contained in these operating instructions carefully.

We wish you much pleasure with your new appliance.

Keep these operating instructions in a safe place and pass them on to the next owner, where applicable. The operating instructions apply to several models. Differences may therefore occur.

Contents

Page

Operating instructions

The appliance at a glance	12
Contents	13
Safety regulations	13
Notes on energy saving	13
Safety instructions and warnings	14
Disposal notes	14
Setting up	14
Connecting to the mains	14
Operation and control elements	15
Switching the appliance on and off	15
Setting the temperature	15
Temperature display	15
Audible warning signal	15
Power failure/FrostControl display	15
Additional functions - child-proof lock	15
Display brightness*	15
SuperFrost	16
Notes on freezing and storage	16
Equipment	17
Information system	17
Freezer tray	17
Cold-storage accumulators	17
Making ice-cubes	17
VarioSpace*	17
Lighting*	17
Cleaning	18
Troubleshooting	18
Customer service and type plate	19
Instructions for installation and modification	
Dimensions	20
Changing over door hinges	20-21

Safety regulations

- The appliance is designed to freeze and store food and to make ice. It is designed as a household appliance. We cannot guarantee that the appliance will work properly if it is used for another purpose.
- The appliance is set to operate within specific ambient temperature limits according to its climate rating. These temperature limits should not be exceeded. The correct climate rating for your appliance is indicated on the type plate. This is explained as follows:
Climate rating Set for ambient temperatures

SN, N	up to +32°C
ST	up to +38°C
T	up to +43°C

- The appliance will function properly in ambient temperatures of down to +5°C.
- The refrigerant circuit has been tested for leaks.
- The appliance complies with current safety regulations and EC directives 73/23/EEC and 89/336/EEC.

Notes on energy saving

- Ensure that there is adequate space around the appliance for ventilation and air extraction.
- Avoid keeping the door open for too long.
- Store food logically. Do not exceed the storage period specified.
- Keep all food properly packed and covered so as to avoid its frosting up on the outside.
- Always allow hot food to cool to room temperature before placing in the appliance.
- Defrost frozen food in the refrigerator.
- Keep the appliance door shut in the event of a breakdown. This will delay the cold loss and will help to maintain the quality of the frozen food for longer.

The insulation plate for running freezer at part capacity

is available as an accessory from your dealer.

If you do not store much frozen food in your freezer you can use the insulation plate to cut your freezer's energy consumption by up to half.

- You can "switch off" any number of drawers up to 5 (depending on model). At least 2 drawers are required for the refrigeration unit to work.

For more information see the instruction manual of the insulation plate.

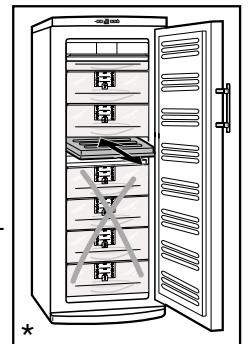

Safety instructions and warnings

Disposal notes

The packaging is designed to protect the appliance and individual components during transport and is made of recyclable materials.



- Corrugated board/board
- Moulded polystyrene (foamed, CFC-free polystyrene)
- Polythene bags and sheets
- Polypropylene straps

- **Keep packaging materials away from children - polythene sheets and bags can suffocate!**

- Please return the packaging material to your nearest official collection point so that the various materials can be reused or recycled as far as possible.



Your old appliance:

This contains some reusable materials and should be disposed of properly - not simply with unsorted household refuse.

- Disable discarded appliances immediately by removing the plug and cutting through the connection cable.
- Remove the spring-action or bolt catch from the appliance so that playing children cannot become trapped inside and suffocate.
- Make sure that the refrigerant circuit of an appliance that is no longer needed is not damaged before it is collected or handed in at a municipal collection point so as to ensure that the refrigerant or oil does not escape into the environment.
- Exact details of the refrigerant used can be found on the type plate. The heat insulator is PU with Pentane.
- Information on collection dates or collection points can be obtained from the waste disposal authorities or your local council.

Technical safety



- To prevent injury or damage to the unit, the appliance should only be transported wrapped and set up by two people.
- The refrigerant R 600a is environmentally friendly but flammable.
- Do not damage the refrigerant circuit pipes. Splashes of refrigerant can harm your eyes or ignite.
- If refrigerant escapes, remove all naked flames or sources of ignition in the vicinity of the leak, disconnect the appliance from the mains and ventilate the area well.
- In the event that the appliance is damaged, contact the supplier immediately before connecting to the mains.
- To guarantee safe operation, ensure that the appliance is set up and connected as described in these operating instructions.
- Disconnect the appliance from the mains if any fault occurs. Pull out the plug (not by pulling on the mains cable) or switch off or remove the fuse.
- **Any repairs and work on the appliance should only be carried out by the customer service department, as unauthorised work could prove highly dangerous for the user.** The same applies to changing the mains power cable.



Safety during use



- Do not store explosives or sprays using combustible propellants such as butane, propane, pentane, etc. in the appliance. Electrical components might cause leaking gas to ignite. You can identify such sprays by the printed contents or a flame symbol.
- Only store high-percentage alcohol in tightly sealed, upright containers.
- Do not allow naked flames or ignition sources to enter the appliance.
- Do not use electrical appliances inside the appliance (e.g. steam cleaners, heaters, ice makers, etc.).
- Do not stand on the plinth, drawers or doors or use them to support anything else.
- This appliance is not intended for use by persons (including children) with reduced physical, sensory or mental capabilities or lack of experience and knowledge unless they have been given initial supervision or instruction concerning use of the appliance by a person responsible for their safety. Children should be supervised to ensure that they do not play with the appliance.

- Avoid prolonged skin contact with cold surfaces or chilled/frozen food. This could cause pain, numbness and frostbite. In the case of prolonged skin contact, protective measures should be taken, e.g. gloves should be worn.
- Do not eat ice-cream, particularly ice lollies or ice-cubes, immediately after taking them from the freezer compartment as there is a risk of "burning" because of the very cold temperatures.
- Do not consume food which has been stored for too long, as it could cause food poisoning.

Setting up

- When setting up/fitting ensure that the refrigerant circuit pipes are not damaged.
- Once in position, use the 10 spanner provided to adjust the feet so that the appliance is level and does not wobble. 
- Avoid positioning in direct sunlight or next to an oven, radiator or similar, in damp locations or near spraying water. The basement is an ideal site for installation.
- Standard EN 378 specifies that the room in which you install your appliance must have a volume of 1 m³ per 8 g of R 600a refrigerant used in the appliance, so as to avoid the formation of inflammable gas/air mixtures in the room where the appliance is located in the event of a leak in the refrigerant circuit. The quantity of refrigerant used in your appliance is indicated on the type plate on the inside of the appliance.
- **The ventilation grilles should not be obstructed. Always ensure that there is good ventilation and that the outward flowing air is able to escape.** Please note the appendix concerning installation instructions. 
- Do not place heat-emitting appliances, e.g. microwave oven, toaster, etc., on top of the refrigerator or freezer.
- Remove all transportation safety components.

Connecting to the mains

Power supply (AC) and voltage

at the operating point must comply with the details on the type plate, which is located inside the appliance on the left, fig. A.



- **Connect the appliance with a properly earthed fused plug and socket only.**
- The socket must be fused with a 10 A fuse or higher, it must be away from the rear of the appliance and must be easily accessible.
- *Do not*
 - connect to stand-alone inverters*,
 - operate with so-called energy-saving plugs - this can damage the electronic system,
 - connect to the supply with other equipment using an extension cable - risk of overheating.
- When removing the mains cable from the back of the appliance, remove the **cable holder** so as to avoid vibration noise. The wires in the mains lead are coloured in accordance with the following code: green/yellow = earth, blue = neutral, brown = live.

Warning! This appliance must be earthed.

Non-rewireable plugs BS 1363

If this machine or appliance is fitted with a non-rewireable plug, the following information applies: If the socket outlets are not suitable for the plug supplied with this product, it must be cut off and an appropriate plug fitted. The plug cut from the flexible cord should be disposed of and on no account be inserted into a 13 A socket elsewhere in the house (electric shock hazard).

The fuse cover **must** be re-fitted when changing the fuse, and if the fuse cover is lost the plug **must not** be used until a suitable replacement is obtained. The colour of the correct replacement cover is that of the coloured insert in the base of the plug, or the colour that is embossed in words on the base of the plug (as applicable to the design of the plug fitted). The correct rating of the replacement fuses that are ASTA approved to BS 1362 should be fitted. Replacement fuse covers may be purchased from your local electrical suppliers, electricity showroom or approved service agent.

Operation and control elements

GB

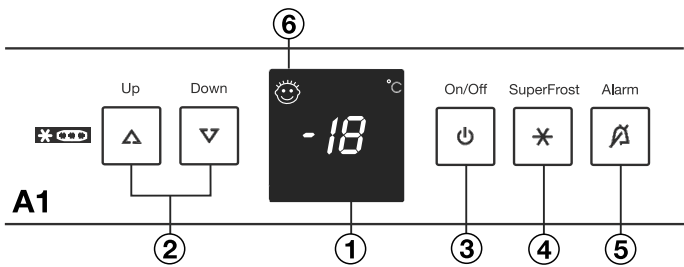

Switching the appliance on and off

- **Switching on:** Press the on/off button ③ so that the temperature display lights up/flashes.
 - When the appliance is switched on for the first time and while it is still warm, the display will contain *dashes* until the temperature falls below 0°C.
 - The Lighting* will light up when the door is open.
- **Switching off:** Press the on/off button for approx. two seconds so that the temperature display goes out.

Setting the temperature

The appliance is pre-set for normal operation. We recommend a temperature of -18°C.

- **To reduce the temperature:**
Press the DOWN button ②.
- **To increase the temperature:**
Press the UP button ②.
- While you are entering the temperature, the **set temperature will flash** on the display.
- When you press the temperature setting buttons for the first time, the *most recent setting* (known as the "*reference setting*") is displayed.
- You can change the settings in increments of 1°C by briefly pressing the buttons again. If the buttons are held down the temperature setting will change faster.
- The electronic controls will switch over automatically about 5 seconds after the last time you pressed the button, and the *actual* temperature in the freezer (known as the "*actual setting*") will be displayed.
- The temperature can be set at between -14°C and -28°C. Whether you can obtain the lowest temperature depends on where the appliance is positioned (if it is located in an area with a high ambient temperature it will not reach the lowest temperature).

Temperature display

The *highest temperature of the frozen food* ① is displayed in normal operating mode.

The display will flash:

- if you change the temperature or
- if the temperature rises by several degrees, indicating cold loss, e.g. if you place fresh, "warm" food in the freezer or if you remove or re-pack frozen food the temperature may rise for a short time due to warm air flowing into the freezer. Once you have finished loading or re-packing, the electronics will automatically re-set the temperature to the most recent setting. Short-term rises in temperature will not affect the frozen food.
- If "F 1" to "F 5" appears in the display, the appliance has a fault. Consult the customer service department indicating the fault number displayed as this will tell the technician what kind of irregularity has occurred.

Audible warning signal

The audible warning signal helps to protect frozen food and to save energy.

- **The audible warning device is switched off** by pressing the audible warning button ⑤.
 - It switches off automatically as soon as the temperature is low enough or the door is closed.

Audible door alarm

- This sounds when the door has been left open for longer than about 60 seconds. The sound switch-off function is active as long as the door is left open. The alarm automatically switches back to standby when the door is shut.

Audible/visual temperature alarm

- It always sounds if the freezer temperature is not low enough (dependent on the temperature setting).
- The *temperature display flashes* at the same time.

This can be caused by:

- warm, fresh food being placed in the freezer,
- too much warm air from the outside entering when re-arranging or removing frozen food.

The temperature display will continue to *flash* until the cause of the alarm has been rectified. It will then stop flashing and light up continually. The audible warning signal is now automatically *reset*.

Power failure/FrostControl display

If *nR* appears in the display, this means that the freezer temperature has risen too *high* during the last few hours or days due to a power failure.



- If you press the audible warning on/off button ⑤ whilst the display is reading *nR*, the *highest* temperature registered during the power failure will be displayed.
- Check the quality of the food and its suitability for consumption in case it has become too warm or even defrosted.
- The highest temperature will appear for approx. 1 minute. After that, the actual temperature in the freezer will re-appear. The display can be switched off by pressing the audible warning on/off button.

Once the power is re-instated, the appliance will continue to operate at the most recent temperature setting.

Additional functions

In set-up mode you can set the **child-proof lock** and adjust the **brightness of the display***:

Activating set-up mode:

- Press SuperFrost button for approx. 5 secs - the SuperFrost button flashes - the display shows **c** for child-proof lock.
 - Note: the value to be altered flashes.
- Select the required function by pressing the Up/Down button:
 - c** = **child-proof lock** or **h** = **brightness**.
- Now select/acknowledge function by pressing SuperFrost button briefly:
 - For **c** = **child-proof lock**, press the Up/Down button to select **c1** = child-proof lock **on** or **c0** = child-proof lock **off** and acknowledge with the SuperFrost button. When the symbol ⑥ is lit, the child-proof lock is activated.
 - For **h** = **brightness**, press Up/Down button to select **h1** = **minimum** to **h5** = **maximum** brightness and acknowledge with the SuperFrost button.



Exit set-up mode:

- To exit the set-up mode, press the On/Off button; after 2 mins. the electronic system switches over automatically.
- The normal operating mode is activated again.

SuperFrost, notes on freezing and storage

SuperFrost

fig. A1

Fresh food should be frozen to the core as rapidly as possible. Frozen food can also be given a cold boost. This is provided by the SuperFrost facility and ensures that the nutritional value, appearance and flavour of the food remain intact.

- The maximum amount of food which can be frozen in 24 hours is shown on the type plate ("Freezing capacity ... kg/24h"), fig. A2, pos. ④. This amount varies according to the model and climate rating.

Freezing with SuperFrost

- Press the SuperFrost button ④ briefly so that it lights up.

SuperFrost



The freezer temperature will decrease and the appliance will switch to the lowest temperature.

- For small amounts of frozen food, it is normally sufficient to switch on SuperFrost 6 hours beforehand. For the *maximum* amount (see freezing capacity on the type plate) you will need to switch it on 24 hours beforehand.
- Then place the fresh food inside the freezer, preferably in the top drawers.

If freezing the *maximum* quantity of food, do *not* use the drawers; instead, place the wrapped food directly on the shelves. Once the food is frozen you can load it into the drawers.

- The SuperFrost function switches off **automatically**. Depending on the quantity of food placed in the freezer, this will normally be between 30 and max. 65 hours. The freezing process is now complete, the **SuperFrost button will go dark**, and the freezer will switch back to normal energy-saving operation.

Note: When the SuperFrost function is activated the appliance will be running at full capacity, so the refrigeration unit will sound slightly louder for a while.

You should *not* switch on the SuperFrost function:

- when placing frozen food in the freezer;
- when freezing up to approx. 2 kg fresh food daily.

Notes on freezing and storage

- **Items suitable for freezing:** meat, game, poultry, fresh fish, vegetables, fruit, dairy products, bread, baked goods, pre-cooked meals.
Not suitable: lettuce, radishes, grapes, whole apples and pears, fatty meat.
- **Pack frozen food** in standard freezer bags or reusable plastic, metal or aluminium containers.
- Do not allow fresh food which is to be frozen to come into contact with food already frozen. Always keep packs dry in order to avoid them sticking together.
- Always write the date and contents on the pack and do not exceed the stated storage time for the food. This prevents any risk of quality impairment.
- Pack food which you are freezing yourself in quantities appropriate to your household. To ensure that the food freezes right through quickly, the following quantities should not be exceeded per package:
 - fruit, vegetables: up to 1 kg;
 - meat: up to 2.5 kg.

- Blanch **vegetables** after washing and cutting them. (Add to boiling water for 2-3 minutes, remove and quickly cool down in cold water. If you blanch with a steamer or microwave oven, please observe the relevant operating instructions.)
- Do not salt or season fresh food or blanched vegetables before freezing. Only lightly salt and season other food. Some spices can alter their flavour intensity.
- Do not freeze bottles and cans which contain carbonated drinks as they might burst. Drinks can be cooled down quickly, but take the bottles out of the freezer compartment after an hour at the most.

- **Storage:** Each drawer and shelf can take up to 25 kg frozen food.
- If you want to use the maximum net capacity, you can remove the drawers and store items directly on the shelves.

- Always leave the bottom drawer in the appliance.

- **Removing drawers:** Pull forward until the drawer stops and lift out.
- If you have removed the drawers, *do not* cover the fan slits at the back, otherwise the freezer will not work properly.

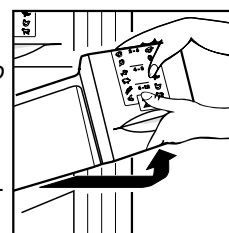













- Always store identical food items together to avoid the door being open for unnecessarily long periods and to save energy.
- Do not exceed storage times given.

- **Thawing:** Only take out as much food as is immediately required for thawing. Cook food which has been thawed as quickly as possible.

Frozen food can be thawed in the following ways:

- in a conventional or fan oven
- in a microwave oven
- at room temperature
- in the refrigerator: the cold given off by the frozen food is used for cooling the other food.
- Flat portions of meat or fish can be cooked when partially thawed.
- Vegetables can be cooked from frozen (in half the normal time).

Equipment

pre-cooked meals		2 - 6		sausages
ice-cream				bread
fish		4 - 8		mushrooms
pork				game
vegetables		6 - 12		poultry
fruit		2		beef/veal

GB

Information system*

Use frozen food within the recommended period. The numbers between the symbols indicate the storage period in months for different kinds of frozen foods. Storage times given are guide times for food frozen at home. Whether or not the lower or upper value is applicable depends on the food quality and how it was processed prior to freezing. The lower values always apply to food with a high fat content.

Freezer tray*

This is used for gently freezing berries, herbs, vegetables and other small items and prevents them from sticking together. Items being frozen will largely retain their shape, and it will be easier to remove exactly the right quantity later on.

- Spread the items out loosely on the tray, fig. H.
- Freeze for 10 to 12 hours, then transfer to a freezer bag or container and put in a drawer.
- To defrost, spread the frozen items out loosely.

Cold-storage accumulators*

These prevent the temperature in the freezer from rising too quickly in the event of a power failure, thus preserving the quality of the food.

- To save space, you can freeze and store the cold-storage accumulators in the freezer tray, fig. I.
- To ensure maximum storage time in the event of a power failure, place the *frozen* cold-storage accumulators in the top freezer drawer on top of the food.

Making ice-cubes

- Fill the ice-cube tray with water.
- Place the ice-cube tray in the appliance and leave it to freeze.
- The ice-cubes can be removed from the tray by twisting or by holding upside down for a short time under running water.

VarioSpace*

- You can create a double-height space for **big items of frozen food** by removing a drawer and a shelf. This enables you to freeze such things as poultry or big pieces of meat without having to cut them up first, so they can be served "whole" afterwards, and to store other large items such as big gateaux or packs of ice.
- **Removing the drawer**, fig. K1: Pull forward until the drawer stops and lift out.
- **Removing the shelf**, fig. K2: Lift up at the front and pull out.
- To insert: proceed in reverse order; simply push shelf in as far as it will go.

Lighting*

This switches off automatically after the door has been opened for approx. 15 minutes. If it does not switch on when the door is opened briefly, but the temperature display is working, the bulb may be defective.

Replacing the bulb:

- **Bulb data:** max. 15 W; current and voltage must agree with the details on the type plate. Only use bulbs of the same size. Bulb fitting: E14.
- Switch off the appliance. **Disconnect from the mains or remove or unscrew the fuse.**
- Change the bulb behind the operating panel as illustrated.

G

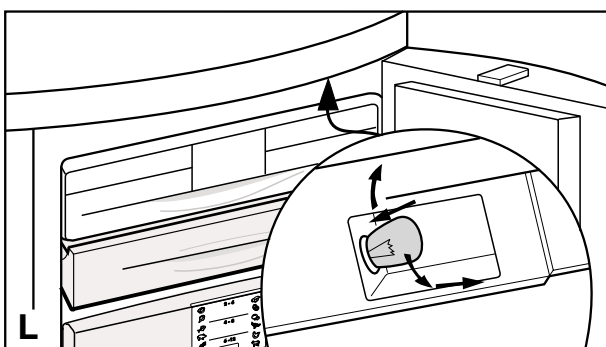
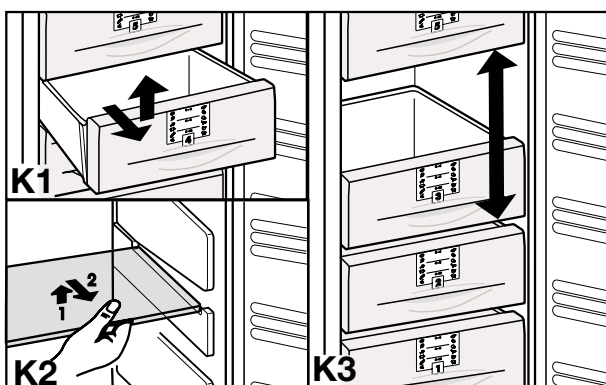
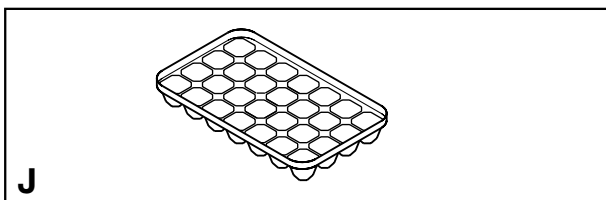
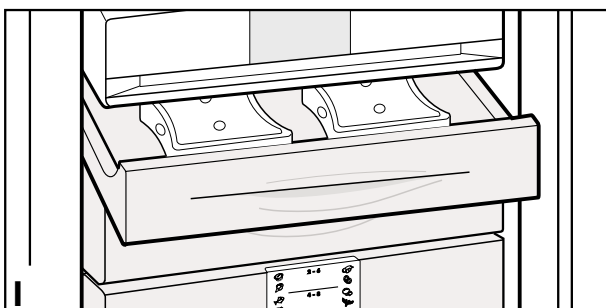
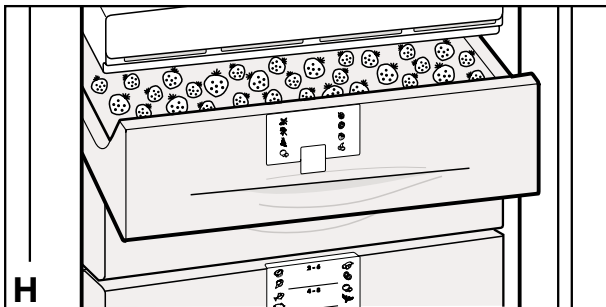

Cleaning

Notes on defrosting

The NoFrost system automatically defrosts the appliance. Any moisture arising collects on the evaporator and freezes, and is periodically defrosted and evaporated. The automatic defrosting system keeps the freezer frost-free and eliminates the time and effort spent on defrosting manually.

Cleaning

- **Always disable the appliance for cleaning. Disconnect from the mains or unscrew or switch off the fuse.**
- Clean the outer walls, inside and equipment by hand with lukewarm water and a little detergent. Because of the risk of injury and damage to the appliance, steam cleaning equipment should not be used.
- We recommend using a soft cloth and an all-purpose cleaner with a neutral pH value. Only use food compatible cleaning and care agents on the inside of the appliance.
- Use a commercially available *stainless-steel cleaning agent* for **stainless-steel appliances***.
- In order to achieve best possible protection, apply a *stainless-steel care agent* uniformly in grinding direction after cleaning. Points which are darker at the start and a more intensive coloration of the stainless-steel surface are normal.
- Do not use abrasive sponges or scourers, do not use concentrated cleaning agents and never use cleaning agents containing sand, chloride or acid or chemical solvents, as these would damage the surfaces and could cause corrosion.
- Ensure that no cleaning water is allowed to penetrate into the electrical components or ventilation grilles. Dry the appliance.
- Do not damage or remove the type plate on the inside of the appliance as this is important for customer service.
- The dust should be removed from the **refrigeration unit** and heat exchanger - metal grid at the back of the appliance - once a year. Dust deposits increase energy consumption.
- Ensure that none of the wires or other components are dislodged, bent or damaged.
- Then connect/switch on the appliance, switch on SuperFrost and start to insert the food to be frozen as the temperature drops.

If the appliance is to be left **out of operation for any length of time**, empty it, disconnect from the mains, clean as described above and leave the door open in order to avoid unpleasant smells.

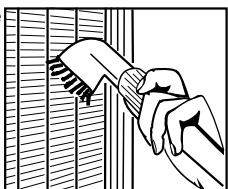

Troubleshooting

Your appliance is designed and manufactured for a long life span and reliable operation. If a malfunction nonetheless occurs during operation, check whether it is due to an operating error. Please note that even during the warranty period the resultant servicing costs in this case will have to be borne by the owner. You may be able to rectify the following faults by checking the possible causes yourself:

Malfunction - Possible cause and remedy

Appliance does not work, the display is off

- Is the appliance switched on properly?
- Is the mains plug properly inserted in the socket?
- Is the socket fuse intact?

The Lighting* does not come on

- Is the appliance switched on?
- Has the door been open for more than 15 minutes?
- The bulb is defective. Check the bulb as described in "Lighting*" and change if necessary.

Loud running noise

- Is the appliance standing firmly on the floor, or does the compressor cause nearby items of furniture or objects to vibrate?

If necessary, move the appliance slightly, align by adjusting the adjustable feet, or move bottles and containers apart.

- *Burbling noises* are normal. These are caused by the refrigerant flowing round the refrigerant circuit.
A short clicking sound: This will be heard whenever the refrigeration unit (the motor) switches on or off automatically.
Motor noise: This will be slightly louder for a brief period when the refrigeration unit switches on. The refrigerating capacity will increase when the SuperFrost function is activated, fresh food has just been placed in the appliance or the door has been left open for a while.

The compressor will continue to run for a while

- On energy saving models, this is caused by the functions and is perfectly normal. When less refrigeration is required, the VCC compressor switches to a low speed. It will then be running almost constantly, but it does save energy

The audible warning signal sounds, the temperature is not cold enough

- Have you put too much fresh food into the freezer *without* activating SuperFrost? (See "SuperFrost")
- Does the door close properly?
- Is the appliance sufficiently well ventilated? Clear ventilation grilles if necessary.
- Is the ambient temperature too hot? (See "Safety regulations")
- Has the appliance been opened too often or left open too long?
- If applicable, wait until the appliance reaches the required temperature itself.

n^o appears in the display

- There has been a power failure; proceed as described in "Power failure/FrostControl display".

The outside of the appliance may feel warm in places

- That is quite normal. The heat from the cooling circuit is used to avoid the formation of condensate.

Customer service and type plate



If none of the above causes apply and you cannot rectify the fault yourself, or if the temperature display reads "F 1 " to " F 5", this means that there is a fault. Please contact your nearest customer service department (see enclosed list for addresses). Give the **fault number displayed**, together with the **type designation** ① , **service number** ② and **appliance number** ③

as given on the type plate, fig. **A2**, so as to ensure rapid, accurate servicing. The type plate is located inside the freezer compartment on the left-hand side.

Leave the appliance shut until the customer service engineer arrives so as to prevent any further cold loss.

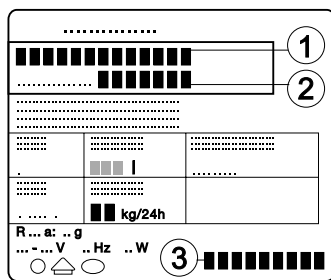

Depending on the model and equipment, your appliance may have an additional interface to which you can connect an optional Net@Home module.

You can choose between a TeleSafe module and a home bus slave module. The modules are available from your dealer.

If your appliance has this interface ① , it will be located at the back of the appliance near the top:

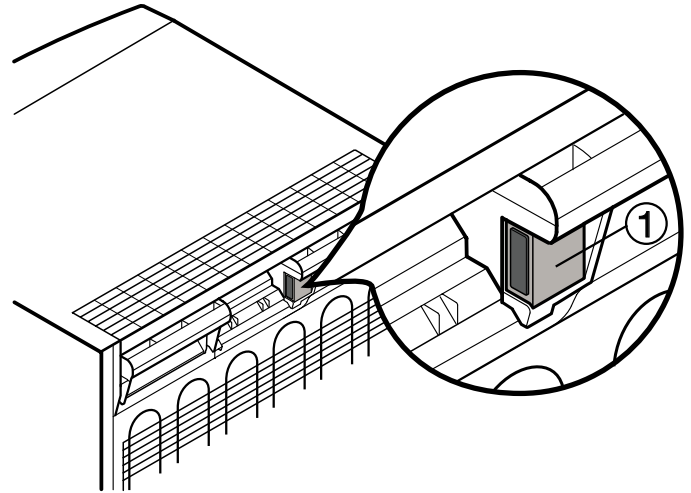

TeleSafe module

The TeleSafe module informs you immediately if your appliance develops a fault.

In the event of a temperature alarm, mains failure or another fault display (F1 to F5), the fault status is immediately forwarded to the alarm contact.

The alarm contact can be connected to any of the following processing units:

- a telephone system with an appropriate signal input,
- an in-house alarm system or building control system,
- an automatic telephone dialling and announcement unit.

In the event of an alarm a programmable number is dialled and a recorded message is played back.

Home bus module

The home bus slave module enables you to integrate your appliance into a home network (EHS Powerline). You can then

- operate all the functions of the appliance or
- display the status of the appliance, e.g. door open alarm, current refrigerator/freezer temperature, or
- assemble the Liebherr **HomeDialogSystem**.

In this way a freezer installed in the basement can be controlled via the display on the combined refrigerator-freezer in the kitchen (setting the temperature, switching SuperFrost or DuraFrost on and off). All display functions (temperature, door alarm, mains failure) can also be called up.

For more information, please visit our website at www.liebherr.com

Instructions for installation and modification

Dimensions

The external dimensions of the appliance can be seen on fig. S and in the table below.

Gross capacity of appliance [l] (see type plate)		External dimensions [mm]					
		A	B	C	D	E	F
162	(18..)	1250	600	631	614	644	1179
200	(21..)	1447	600	631	614	644	1179
238	(25..)	1644	600	631	614	644	1179
276	(28..)	1841	600	631	614	644	1179
188	(20..)	1250	660	683	662	704	1287
233	(24..)	1447	660	683	662	704	1287
279	(29..)	1644	660	683	662	704	1287
324	(33..)	1841	660	683	662	704	1287

Installation instructions

- Do not install the appliance directly next to another refrigerator or freezer. This is important to prevent condensation and consequential damage resulting from it.
- This does not apply to Side-by-Side models (SBS). They are designed for Side-by-Side installation with another refrigerator/freezer.
The "Installation instructions for Side-by-Side combinations" are supplied in the accessories bag for the SBS freezer or the appliance with a freezer compartment.

Changing over door hinges

On appliances which are intended for individual installation the door hinges can be changed from one side to the other. On SBS appliances in stainless steel finish, which are designed for Side-by-Side installation, the door hinges **must not** be transferred to the other side!

- Only change over door hinges when mains plug is disconnected!
- Fig. T. With the door open, lever out plinth panel ① on the hinge side with a screwdriver and remove from front.
- Lever out cover ② with a screwdriver.
Close door.
- Unscrew screw M5 ③.
- Pull hinge component ④ with hinge pin ⑤ out from underneath and remove.
- Open door, lift out at bottom and remove; do not lose the spacer ⑩.
- Transfer all hinge components onto the other side:
- Top: depending on version, proceed as follows:
Version I (visible operating panel): Lever out covers ⑧ with a screwdriver at the front and remove at an angle from below. Remove hinge pin ⑦ and insert on the opposite side. Use the hexagon socket on the open-ended spanner provided (spanner width 5). Fit covers ⑧ again: insert at rear and click into place at front.
Version II (concealed operating panel): Lift up cover ⑧ on handle side, push outwards; lift up cover on hinge side and pull off.
- Unscrew earthing plate ②①: first earthing screw ②②, then inner retaining screw ②③.
- Unscrew hinge ⑨: first undo earthing screw ②②, then retaining screws ②③. Fit hinge ⑨ to opposite side: for easy assembly, fit hinge from above and first tighten with the upper retaining screw ②③ M5, then screw ②③ and finally earthing screw ②② M4.
- Turn earthing plate ②① through 180° and screw tight again on the new handle side: first retaining screw ②③, then earthing screw ②②.
- Insert hinge pin ⑦ in the other retaining hole. Use the

hexagon socket on the open-ended spanner provided (spanner width 5).

- Fit covers ⑧ again: insert hinge-side cover by sliding outwards and click into position; insert handle-side cover by sliding inwards and click into position.
- Bottom: Using a screwdriver, remove the spacer ⑩ and replace on the other side.
- Re-attach the door:
 - Remove plugs ⑭ from the door mounting points and replace on the other side.
 - Suspend door with spacer in hinge pin ⑦, close door.
 - Rotate hinge component ④ by 180°, remove hinge pin ⑤, turn by 180° and replace. Mount both parts in the hinge ⑬: slide the pin into the door mounting through the hinge, tilt in the hinge component, slide up and attach with screw ③.
 - Align the door *flush* with the body of the appliance using the slot on the hinge ⑬, then tighten screw ③.
 - Attach the plinth panel ① and click into place by pressing.
 - With the door open, insert the cover ② in the plinth panel at the front and click into place at the back.
 - Transfer* **door handle ⑬** and plugs ⑭. With the door open, carefully lift out the pressure plates* ⑰ at the front and slide away; unscrew handle.
Re-assemble in reverse order: replace the pressure plates and click into position.

Insertion into row of kitchen units

Fig. U. **600 mm appliances** can be installed in a row of kitchen units. To adapt the height of the appliance to the surrounding furniture a top unit ① can be added.

A gap of at least 50 mm depth must be provided behind and along the entire width of this unit so as to ensure sufficient ventilation. The area of ventilation underneath the ceiling should be at least 300 cm². The greater the area the more economically the appliance will run.

- When installing with standard kitchen units (max. depth 580 mm) and decor panels of max. 2 mm thickness, the appliance can be set up right next to the kitchen unit. The door protrudes 34 mm from the side of the kitchen unit and 51 mm at the front. This enables it to be opened and closed without difficulty.
- When setting up the appliance next to a wall ④, a minimum distance of 36 mm must be provided on the hinge side between the appliance and the wall (for the handle when the door is open).

- ① top unit
- ② refrigerator/freezer
- ③ kitchen unit side panel
- ④ wall

Instructions for installation and modification

GB

Notes on assembling decor panels

with white appliances of width B = 600 mm and height A = 1841 mm:

Decor panel and frames can be attached to the door of your appliance to match or contrast it to the existing kitchen colour scheme.

The panels are available from your kitchen furniture supplier. The frames can be fitted later and are available from your dealer.

If you wish to fit the decor panels yourself, you will need a drill or a rechargeable screwdriver to pre-drill the retaining holes. The door handles are to be replaced by the rigid handles included in the decor frame retrofit kit.

For further instructions and dimensions see the installation instructions included in the retrofit kit.

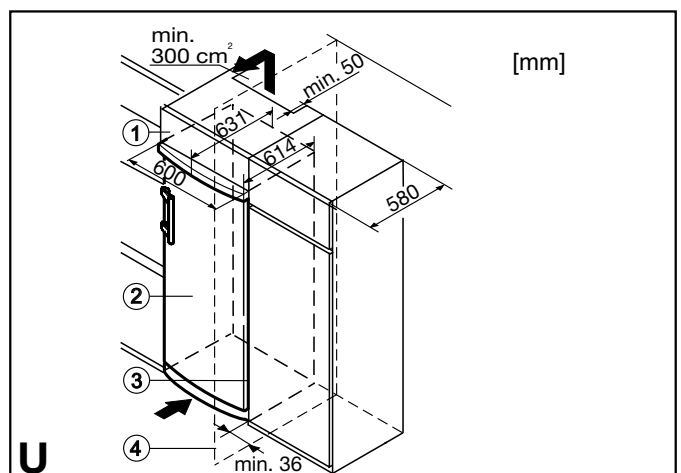
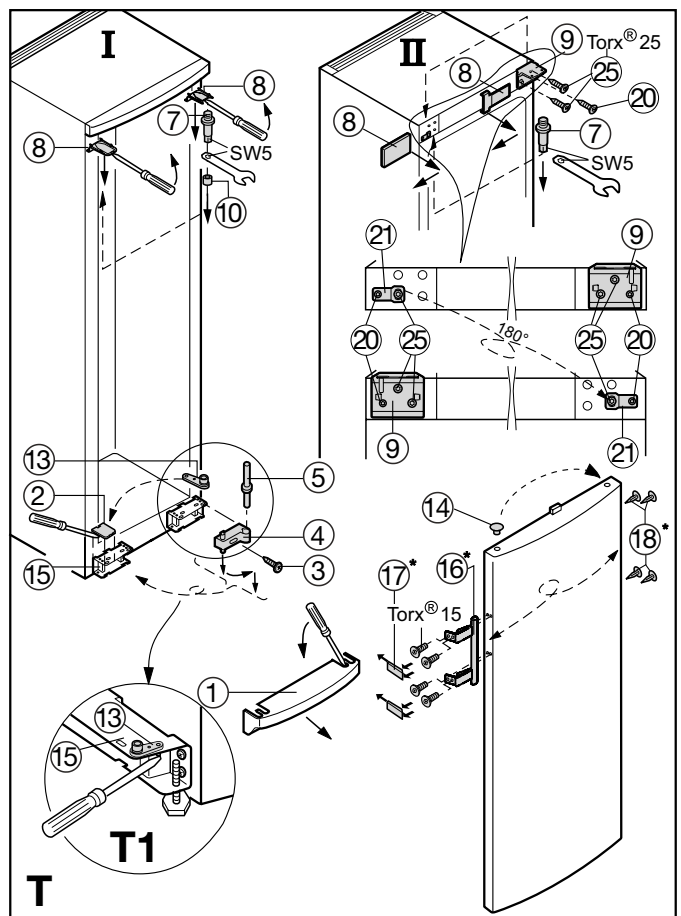
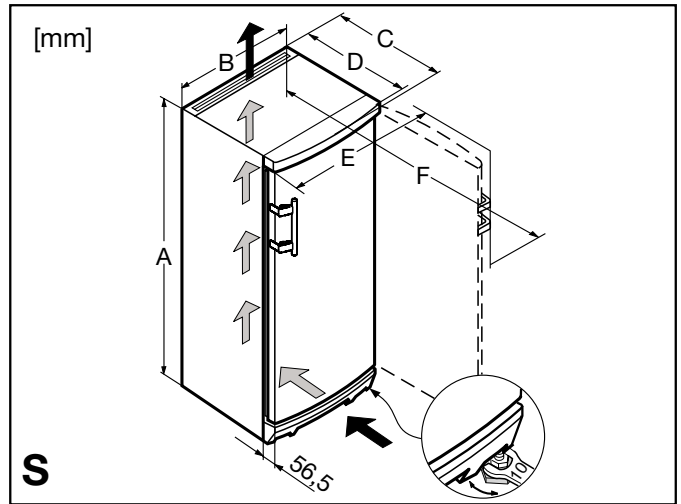

All types and models are subject to continuous improvement and the manufacturer therefore reserves the right to make modifications in the shape, equipment and technology.

Free Manuals Download Website

<http://myh66.com>

<http://usermanuals.us>

<http://www.somanuals.com>

<http://www.4manuals.cc>

<http://www.manual-lib.com>

<http://www.404manual.com>

<http://www.luxmanual.com>

<http://aubethermostatmanual.com>

Golf course search by state

<http://golfingnear.com>

Email search by domain

<http://emailbydomain.com>

Auto manuals search

<http://auto.somanuals.com>

TV manuals search

<http://tv.somanuals.com>