

Ab Crunch Bench

Owner's Manual



LifeFitness

Ab Crunch Bench

1. Assembly Instructions

Item	Description	Qty	Part Number
1	Lower Support	1	LEA78096XX
2	Cam Follower	1	LEA78093XX
3	Screw, M10 X 25mm	13	LEA3251702
4	3/8" Flat Washer	21	LEA3102514
5	Nylock Nut	12	LEA3242002
6	Work Arm Stop	1	LEA78099XX
7	Cross Member	1	LEA78097XX
8	Screw, M10 X 135mm	2	LEA3251721
9	Foot Rest	1	LEA78094XX
10	Back Support	1	LEA78095XX
11	Pad, Large Back	1	LEA74741XX
12	Screw, M10 X 35mm	5	LEA3251704
13	1" Hole Plug	12	LEA3237403
14	Pad, Arm Rest	1	LEA73933XX
15	Pad, Shoulder	1	LEA74689XX
16	Work Arm	1	LEA78098XX
17	Ball Bearing	2	LEA3235601
18	Internal Spacer	1	LEA7799501
19	3/8" Fender Washer	1	LEA3252001
20	Bearing Housing Cap	1	LEA7308701

Tools Required:

- 8mm Allen Wrench
- 17mm Wrench
- Ratchet
- 3" Ratchet Extension
- 17mm Socket
- 8mm Hex Bit

3)

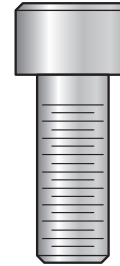

12)

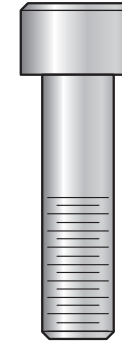

8)

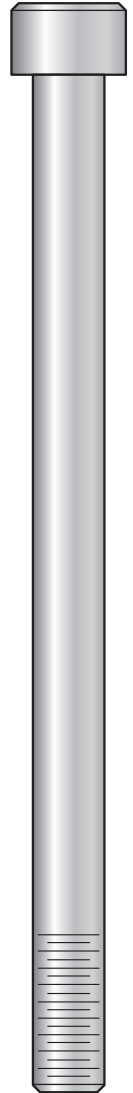

4)

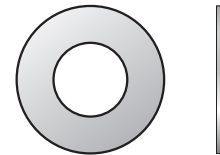

5)

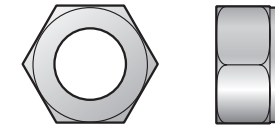

19)

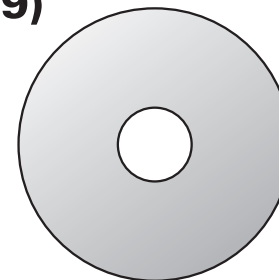

1. Locate the LOWER SUPPORT (1) and the CAM FOLLOWER (2). Using two M10 x 25mm BOLTS (3), FLAT WASHERS (4), and NYLOCK NUTS (5), secure the LOWER SUPPORT to the CAM FOLLOWER. Loosely tighten the BOLTS and NUTS.
2. Locate the WORK ARM STOP (6). With the WORK ARM STOP positioned as shown, align the mounting holes and secure the WORK ARM STOP to the LOWER SUPPORT (1) using two M10 x 25mm BOLTS (3), FLAT WASHERS (4), and NYLOCK NUTS (5). Loosely tighten the BOLTS and NUTS.
3. Locate the CROSSMEMBER (7). With the CROSSMEMBER positioned as shown, align the mounting holes and secure the CROSSMEMBER to the CAM FOLLOWER (2) using two M10 x 135mm BOLTS (8), four FLAT WASHERS (4), and two NYLOCK NUTS (5). Loosely tighten the BOLTS and NUTS.
4. Locate the FOOT REST (9) and BACK SUPPORT (10). Position the FOOT REST and BACK SUPPORT as shown. Align the mounting holes and secure the FOOT REST to the BACK SUPPORT using two M10 x 25mm BOLTS (3), FLAT WASHERS (4), and NYLOCK NUTS (5). Loosely tighten the BOLTS and NUTS.
5. Position the BACK SUPPORT (10) over the WORK ARM STOP (6) and CROSSMEMBER (7) as shown. Align the mounting holes and secure the BACK SUPPORT to the WORK ARM STOP and CROSSMEMBER using four M10 x 25mm BOLTS (3), FLAT WASHERS (4), and NYLOCK NUTS (5). Tighten the BOLTS securely.

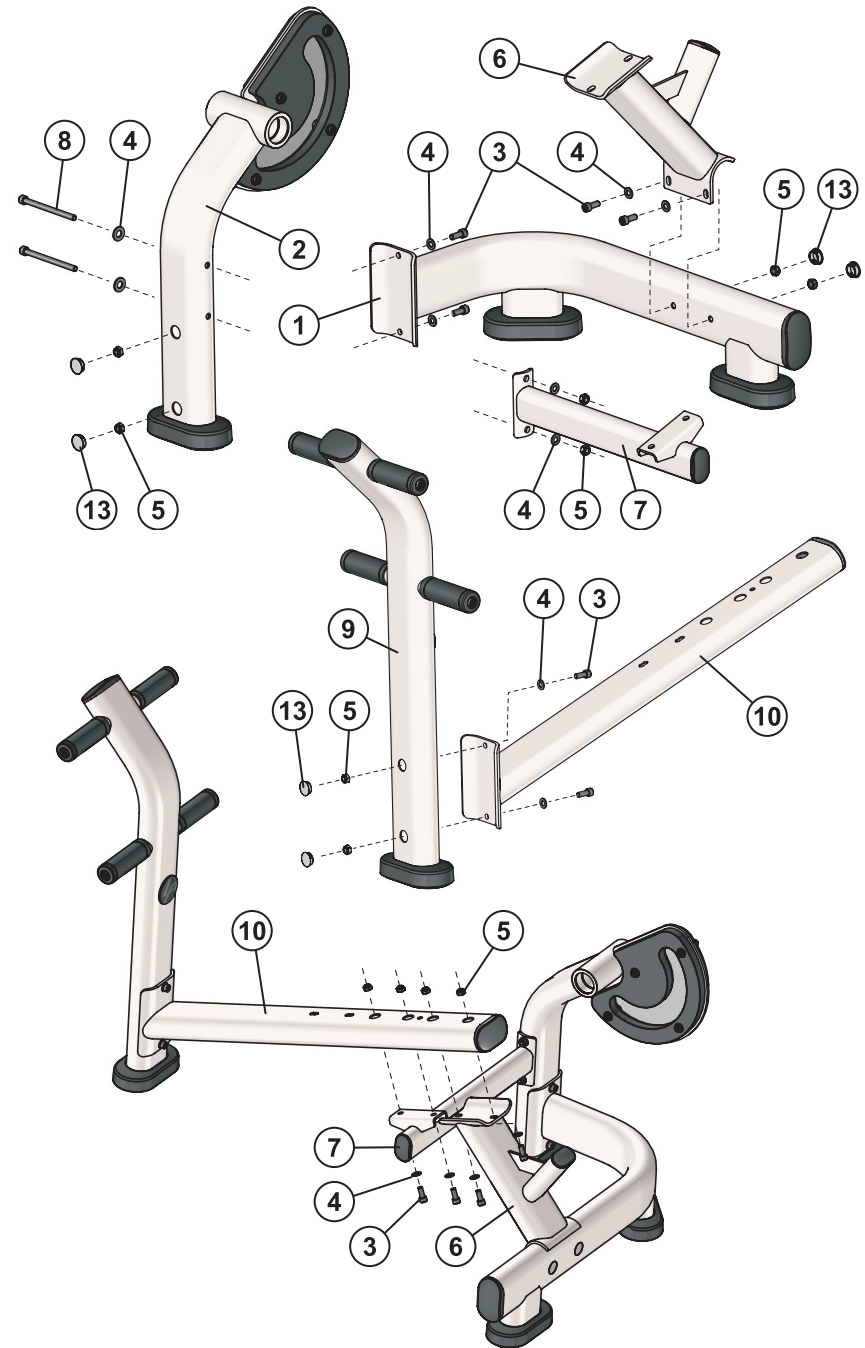

Ab Crunch Bench

1. Assembly Instructions

6. Locate the **LARGE BACK PAD (11)**. Position the **LARGE BACK PAD** over the **BACK SUPPORT (10)** as shown. Align the mounting holes and secure the **LARGE BACK PAD** to the **BACK SUPPORT** using three **M10 x 35mm BOLTS (12)** and **FLAT WASHERS (4)**. Tighten the **BOLTS** securely. Cover the **BOLT** access holes with three **HOLE PLUGS (13)**.
7. Locate the **HEADREST (14)**. Position the **HEADREST** onto the **HEADREST BRACKET (A)** as shown. Align the mounting holes and secure the **HEADREST** using two **M10 x 25mm BOLTS (3)** and **FLAT WASHERS (4)**. Tighten the **BOLTS** securely.
8. Locate the **SHOULDER PAD (15)**. Position the **SHOULDER PAD** over the **WORK ARM (16)** as shown. Align the mounting holes and secure the **SHOULDER PAD** using two **M10 x 35mm BOLTS (12)** and **FLAT WASHERS (4)**. Tighten the **BOLTS** securely.
9. Slide one **BEARING (17)** over the **PIVOT POST (B)**. Slide the **SPACER (18)** over the **PIVOT POST**. Slide the **PIVOT POST** through the **PIVOT HUB (C)** until the **BEARING** is fully seated. Slide a second **BEARING** over the exposed end of the **PIVOT POST** until fully seated into the **PIVOT HUB**. Secure the **PIVOT POST** into the **PIVOT HUB** using the **M10 x 25mm BOLTS (3)** and **FENDER WASHER (19)**, Tighten the **BOLT** securely. Cover the exposed end of the **PIVOT HUB** with the **PIVOT HUB CAP (20)**.
10. Tighten all remaining **BOLTS** securely. Cover all remaining open **BOLT** access holes with **HOLE PLUGS (13)**.

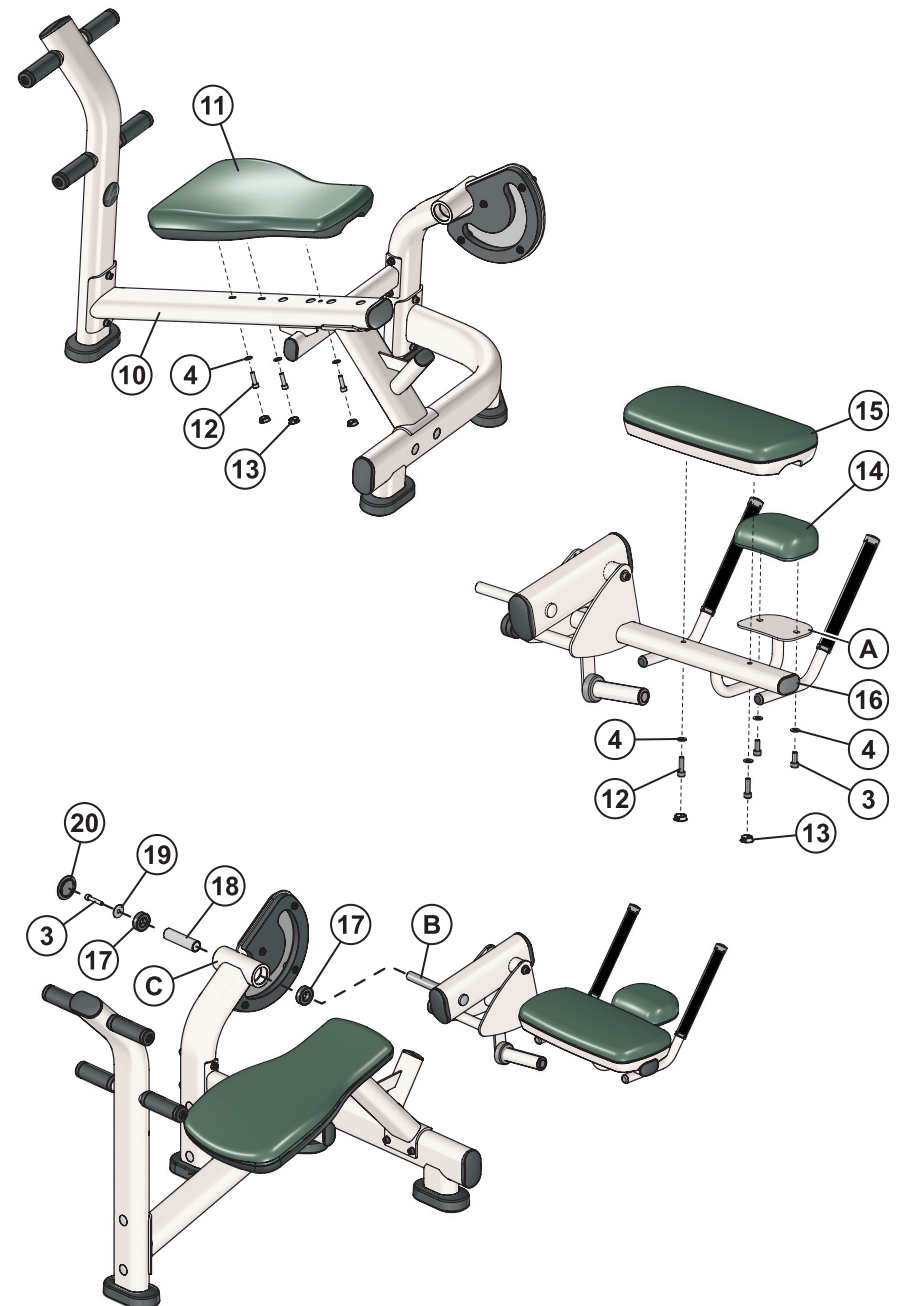

Abdominal Crunch

2. Safety & Warranty

It is the sole responsibility of the purchaser of Life Fitness products to instruct all individuals, whether they are the end user or supervising personnel on proper usage of the equipment.

It is recommended that all users of Life Fitness exercise equipment be informed of the following information prior to its use.

PROPER USAGE

1. Do not use any equipment in any way other than designed or intended by the manufacturer. It is imperative that all Life Fitness equipment is used properly to avoid injury.
2. Keep hands and feet clear at all times from moving parts to avoid injury.
3. It is the purchaser's sole responsibility to properly instruct end users and supervising personnel as to the proper operating procedures of all Life Fitness equipment.

CHECK FOR DAMAGED PARTS

1. DO NOT use any equipment that is damaged and or has worn or broken parts. Use only replacement parts supplied by Life Fitness.
2. MAINTAIN LABELS AND NAMEPLATES. Do not remove labels for any reason. They contain important information. If unreadable or missing, contact LIFE FITNESS for a replacement.
3. SECURE EQUIPMENT. All equipment MUST be secured to the floor to stabilize and eliminate rocking or tipping over. This must be performed by a licensed contractor.
4. Ensure that any person(s) making adjustments or performing maintenance or repair of any kind is qualified to do so. Life Fitness will provide service and maintenance training at our corporate facility upon request or in the field if appropriate arrangements are made.

SPECIFIC OPERATING WARNINGS

1. Do not allow users to wear loose fitting clothing while using equipment. It is also recommended to have users secure long hair back and up to avoid contact with moving parts.
2. It is the purchaser's sole responsibility to properly instruct end users and supervising personnel as to the proper operating procedures of all Life Fitness equipment.
3. Keep children away from strength equipment. Parent or others supervising children must provide close supervision of children if the equipment is used in the presence of children.
4. Use Olympic Weight Plates to incrementally increase resistance. Never use dumbbells or other means to incrementally increase weight resistance.
5. UNDERSTANDING EACH AND EVERY WARNING TO THE FULLEST EXTENT IS IMPORTANT. IF ANY OF THESE WARNINGS ARE UNCLEAR, ASK FOR CLARIFICATION FROM LIFE FITNESS PERSONNEL.
6. It is recommended that all individuals consult a physician prior to commencing an exercise program. If at any time during exercise a exerciser feels faint, dizzy or experience pain, he/she should stop and consult a physician.



Ab Crunch Bench

2. Safety & Warranty

WARRANTY

WHAT IS COVERED

This Life Fitness commercial exercise equipment (Ab Crunch Bench) is warranted to be free of all defects in material and workmanship.

WHO IS COVERED

The manufacturer's warranty covers the original purchaser or any person receiving the Product as a gift from the original purchaser.

WHO PAYS TRANSPORTATION & INSURANCE FOR SERVICE

If the Product or any covered part must be returned to a service facility for repairs, Life Fitness, will pay all transportation and insurance charges for the first year. The purchaser is responsible for transportation and insurance charges during the second and third years (if applicable).

WHAT WE WILL DO TO CORRECT COVERED DEFECTS

Life Fitness will ship any new or rebuilt replacement parts or components, or, at the option of Life Fitness, replace the Product. Such replacement parts are warranted for the remaining portion of the original warranty period.

WHAT IS NOT COVERED

Any failures or damage caused by unauthorized service, misuse, accident, negligence, improper assembly or installation, debris resulting from any construction activities in the Product's environment, rust or corrosion as a result of the Product's location, alterations or modifications without our written authorization or by failure on the purchaser's part to use, operate and maintain the Product as set out in your Owner's Manual (.Manual.). All terms of this warranty are void if this Product is moved beyond the continental borders of the United States of America (excluding Alaska, Hawaii and Canada) and are then subject to the terms provided by that country's local authorized Life Fitness representative.

OWNER'S MANUAL

It is VERY IMPORTANT THAT YOU READ THIS MANUAL before operating the Product. Remember to perform the periodic maintenance specified in the Manual to assure proper operation and continued satisfaction with the Product.

HOW TO GET PARTS & SERVICE

Call Customer Support Services at (800) 351-3737 or (847) 451-0036, Monday through Friday from 8:00 a.m. to 6:00 p.m. Central Standard Time. Have the following information available when calling; name, address and serial number of the Product. Life Fitness will provide information on how to obtain a replacement part, advice on how and where to ship the Product for service or, if necessary, arrange for on-site service.

Before shipping the Product:

1. Obtain a Return Authorization Number (RA#) from Customer Support Services
2. Securely pack your Product (use the original shipping carton, if possible)
3. Write the RA# on the outside of the carton
4. Insure the Product, and
5. Include a letter explaining the defect or problem and a copy of the proof of purchase if you believe the service is covered by warranty.

EXCLUSIVE WARRANTY

THIS LIMITED WARRANTY IS IN LIEU OF ALL OTHER WARRANTIES OF ANY KIND EITHER EXPRESSED OR IMPLIED, INCLUDING BUT NOT LIMITED TO THE IMPLIED WARRANTIES OF MERCHANTABILITY AND FITNESS FOR A PARTICULAR PURPOSE, AND ALL OTHER OBLIGATIONS OR LIABILITIES ON THE PART OF LIFE FITNESS. Life Fitness neither assumes nor authorizes any person to assure for Life Fitness any other obligation or liability concerning the sale of this Product. Under no circumstances shall Life Fitness be liable under this warranty, or otherwise, of any damage to any person or property, including any lost profits or lost savings, for any special, indirect, secondary, incidental or consequential damages of any nature arising out of the use of or inability to use this Product. Some states do not allow the exclusion or limitation of implied warranties or of liability for incidental or consequential damages, so the above limitations or exclusions may not apply in those instances.

CHANGES IN WARRANTY NOT AUTHORIZED

No one is authorized to change, modify or extend the terms of this limited warranty.

EFFECT OF STATE LAWS

This warranty gives you specific legal rights and you may have other rights, which vary, from state to state.

THE LIFE FITNESS PLEDGE TO YOU

Life Fitness Products are designed and manufactured to the highest standards.

Life Fitness wants its customers to be completely satisfied with the its Product and will do everything possible under the terms of this warranty to keep its customers secure in knowing they have bought the best!

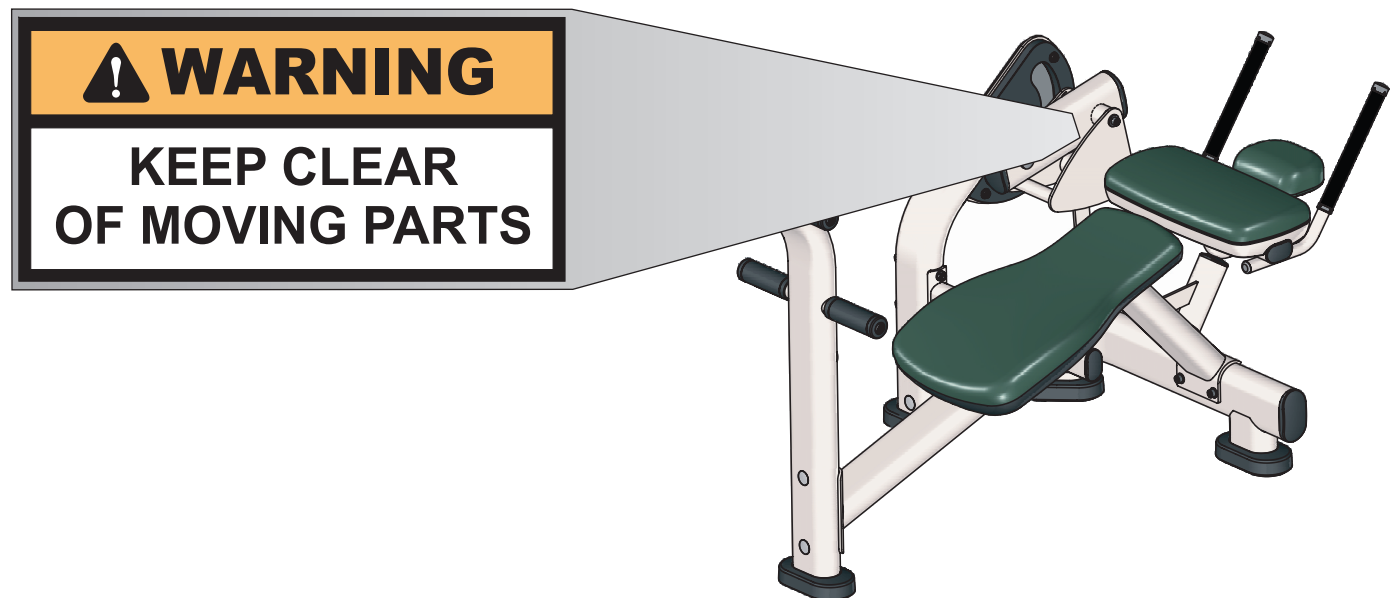

LifeFitness

General Specifications

1. Frame Construction

Frame is constructed of mechanical quality steel purchased in mill run quantities.
Frame is primarily 2 ½" x 4 ½" oval-shaped tubing with 11 gauge wall thickness.

2. Frame Finish

Prior to applying finish, each part is chemically washed to prepare surface for maximum adhesion.

3. Weight Horn

Weight horn under the head pad gives users the ability to increase resistance with Olympic weight plates. This allows flexibility for all users in all phases of their training.

4. Cam

The cam is CNC machined from solid polymer and designed to match the appropriate muscle strength capability curve.

5. Integral Bearings

Bearings are sealed bearings with a basic radial load rating of over 2,000 pounds. Bearings are mounted within precision-machined housings for optimal alignment, which results in smooth and friction free movement.

6. Bolts

All hardware is metric and has a corrosion resistant finish.

7. Upholstery

Contoured pads.

All edges are stitched to eliminate any folds in the material that would limit durability.

8. Foam

Three and four pound EVA foam (deformation resistant) or equivalent is used on all machines. The foam is injection molded directly to the multiply wood support board with integral 10mm T-nuts.

9. Hand Grips

Hand grips are an extruded 60-durometer-thermorubber compound that is non-absorbing, wear and tear resistant, and exhibits good dry and wet frictional characteristics.

The grips are retained with aluminum collars, which eliminate the tendency of the grips to slide off the handle.

10. Foot Platforms

Foot platforms are molded rubber with a slip resistant texture.

11. Instructional Placard

Visual placard provides illustration for proper use.

12. Equipment Anchoring

All machines have holes in the feet, which allow for easy anchoring to the floor. Life Fitness recommends that all machines be anchored to the floor to minimize the possibility of tipping.

13. Warranty

10-year minimum warranty on frames, 5 years on integral bearings, 1 year on grips, and 90 days on upholstery and any items not specified.

14. Liability Insurance

Certificate of insurance available upon request.

Product Specifications

AB CRUNCH BENCH Product # - **SABC**

Machine Weight: 141 lbs. 64 kg.

Size: in = 64L x 32W x 42H cm = 163 L x 81 W x 107 H

Live Area: in = 72L x 50W x 42H cm = 183 L x 127 W x 107 H

- Dual cam mechanism creates a natural crunch style movement for effective abdominal contraction minimizing hip flexor assistance.
- Bench design is optimized for easy entry/exit and greater stabilization.
- Contoured cushions utilize a molded foam for greater comfort.
- Standard weight horn allows users to add resistance.



Ab Crunch Bench

4. Exercise

Muscles Exercised -Abdominals

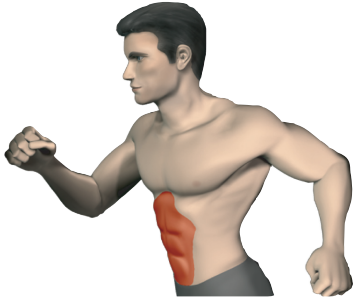

Setup

Check weight horn for appropriate resistance. Lay down on Ab Crunch Bench with head near the top of the head pad and shoulders flat on the middle pad. Grasp handles and place feet on the foot pegs that are most comfortable.

Performing the Exercise

Grasp handles and slowly contract abdominals until body is in a crunch position. Slowly return to start position and repeat without letting the movement arm rest on its support.

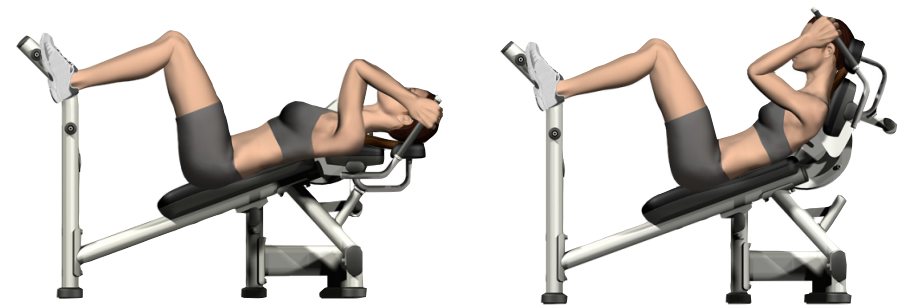

Start

Finish

Abdominal Crunch

5. Maintenance

ONCE A DAY

- Wipe down upholstery with a mild soap and water or comparable all purpose cleaner.

ONCE A WEEK

- Visually inspect all hardware for loosening, tampering or wear.
- Check condition of hand grips.

ONCE A MONTH

- Inspect hardware and tighten any bolts or nuts that may have loosened during use.

ACTION	DAILY	MONTHLY	BI-ANNUALLY	AS NEEDED
CLEAN				
Upholstery	X			
Hand Grips				X
INSPECT				
Hardware		X		
Frame			X	
Hand Grips				X

CLEAN

- Upholstery with a mild soap and water.
- Hand grips with mild soap and water.

INSPECT

- Hardware should be checked for looseness. Tighten as required using metric tools.
- Frames should be inspected for wear or damage.
- Hand grips should be checked for wear or damage.

NOTE: Use polishing compound (such as car wax) to clean and remove shoe scuffs from frame surfaces as necessary.



Free Manuals Download Website

<http://myh66.com>

<http://usermanuals.us>

<http://www.somanuals.com>

<http://www.4manuals.cc>

<http://www.manual-lib.com>

<http://www.404manual.com>

<http://www.luxmanual.com>

<http://aubethermostatmanual.com>

Golf course search by state

<http://golfingnear.com>

Email search by domain

<http://emailbydomain.com>

Auto manuals search

<http://auto.somanuals.com>

TV manuals search

<http://tv.somanuals.com>