

CLUB SERIES ELLIPTICAL CROSS-TRAINER

USER MANUAL



Life Fitness

CORPORATE HEADQUARTERS

5100 North River Road
Schiller Park, Illinois 60176 • U.S.A.

www.lifefitness.com

INTERNATIONAL OFFICES

LIFE FITNESS ASIA PACIFIC LTD

Room 2610, Miramar Tower
132 Nathan Road
Tsimshatsui, Kowloon
HONG KONG

LIFE FITNESS ATLANTIC BV

LIFE FITNESS BENELUX

Bijdorpplein 25 - 31
2992 LB Barendrecht
THE NETHERLANDS

LIFE FITNESS DO BRAZIL

Av. Dr. Dib Sauaia Neto 1478
Alphaville, Barueri, SP
06465-140
BRAZIL

LIFE FITNESS VERTRIEBS GMBH

Dückergrasse 7-9/3/36
1220 Vienna
AUSTRIA

LIFE FITNESS IBERIA

Pol. Ind. Molí dels Frares. c/C, nº 12
08620 Sant Vicenç dels Horts (Barcelona)
SPAIN

LIFE FITNESS EUROPE GMBH

Siemensstrasse 3
85716 Unterschleissheim
GERMANY

LIFE FITNESS ITALIA S.R.L.

Via Crivellin 7/N
37010 Affi Verona
ITALY

LIFE FITNESS LATIN AMERICA and CARIBBEAN

5100 North River Road
Schiller Park, Illinois 60176
U.S.A.

LIFE FITNESS UK LTD

Queen Adelaide
Ely, Cambs CB7 4UB
UNITED KINGDOM

LIFE FITNESS JAPAN

Nippon Brunswick Bldg., #8F
5-27-7 Sendagaya
Shibuya-Ku, Tokyo
JAPAN 151-0051

M051-00K61-A117

09/07

Before using this product, it is essential that this ENTIRE operation manual and ALL installation instructions be read.

This will help in setting up the equipment quickly and in instructing others on how to use it correctly and safely.

Avant toute utilisation de ce produit, il est indispensable de lire ce manuel d'utilisation dans son INTÉGRALITÉ, ainsi que TOUTES les instructions d'installations.

Ce manuel explique comment installer l'équipement et comment l'utiliser correctement et sans danger.

Class H (Home): Domestic use.



CAUTION: Any changes or modifications to this equipment could void the product warranty.



MISE EN GARDE: Tout changement et toute modification de ce matériel peut annuler la garantie du produit.

Any service, other than cleaning or user maintenance, must be performed by an authorized service representative. There are no user serviceable parts.

TABLE OF CONTENTS

Section	Description	Page
1.	Getting Started	6
1.1	Important Safety Instructions	6
1.2	Setup	8
	Where to Place the Life Fitness® Cross-trainer // How to Stabilize the Life Fitness Cross-trainer // Plug In the Life Fitness Cross-trainer	
2.	The Display Console	10
2.1	Display Console Overview	10
2.2	Display Console Descriptions	11
2.3	The Accessory Tray / Reading Rack	14
3.	Heart Rate Zone Training Exercise	15
3.1	Why Heart Rate Zone Training Exercise	15
3.2	Heart Rate Monitoring	16
	The Lifepulse™ Digital Heart Rate Monitoring System // The Polar® Telemetry Heart Rate Monitoring Chest Strap	
4.	The Workouts	18
4.1	Workout Overviews	18
4.2	Using the Workouts	20
	To Begin a Workout // Selecting and Using Quick Start // Selecting a Workout // Entering Weight // Entering Age // Entering Time // Selecting and Adjusting the Resistance Level // Selecting a Workout Mode // Switching Workouts on the Fly // Life Fitness Cross-trainer Workout Setup Steps (chart) // Pausing Workouts // Ending Workouts Early	

4.3	Workout Descriptions	25
	Quick Start // Manual // Random // Sport Training™ Workout // EZ Resistance // Fat Burn // Cardio // Heart Rate Hill™ Workout // Heart Rate Interval™ Workout // Extreme Heart Rate™ Workout // Hill // Six Pre-set Workouts // Cross-train Aerobics // Cross-train Reverse Watts // Mets	
4.4	Using My Workouts Personal Programs	34
	My Workouts Key // My Workouts Naming-Programming // My Workouts Operating Parameters // Using a Workout Saved Under My Workouts // Editing Settings for Workouts Saved Under My Workouts // My Workouts Statistics-Programming // My Workouts User Statistics // My Workouts Change Workout Programming // Workout Profiles Key	
5.	Optional Settings	37
5.1	Entering and Using the Optional Settings Feature	37
6.	Service And Technical Data	38
6.1	Preventive Maintenance Tips	38
6.2	Preventive Maintenance Schedule	39
6.3	Troubleshooting the Lifepulse System Sensors	39
6.4	Troubleshooting the Polar Heart Rate Chest Strap	40
	Heart Rate Reading Is Erratic or Absent Entirely // Heart Rate Reading Is Erratic or Extremely High	
6.5	How to Obtain Product Service	41
7.	Warranty Information	42
8.	Specifications	45
8.1	Life Fitness Club Series Elliptical Cross-Trainer Specifications	45

© 2007 Life Fitness, a division of Brunswick Corporation. All rights reserved. Life Fitness is a registered trademarks of Brunswick Corporation. HeartSync, Sports Training, My Workouts, Heart Rate Hill, Heart Rate Interval, Extreme Heart Rate, and Lifepulse are trademarks of Brunswick Corporation. Polar is a registered trademark of Polar Electro, Inc. Any use of these trademarks, without the express written consent of Life Fitness or the corresponding companies is forbidden.

This User Manual describes the functions of the following product:

Life Fitness rear drive total body cross-trainer

Club Series Elliptical Cross-Trainer

See "Specifications" page in this manual for product specific features.

Statement of Purpose: The Life Fitness cross-trainer is an exercise machine that combines low-impact elliptical pedaling with push/pull arm motion to provide an efficient, effective total body workout.



Health-related injuries may result from incorrect or excessive use of exercise equipment. Life Fitness **STRONGLY** recommends seeing a physician for a complete medical exam before undertaking an exercise program, particularly if the user has a family history of high blood pressure or heart disease; or is over the age of 45; or smokes, has high cholesterol, is obese, or has not exercised regularly in the past year. Life Fitness also recommends consulting a fitness professional on the correct use of this product.

If, at any time while exercising, the user experiences faintness, dizziness, pain, or shortness of breath, he or she must stop immediately.



Des problèmes de santé peuvent être causés par une utilisation incorrecte ou excessive de l'équipement. Life Fitness conseille **VIVEMENT** de consulter un médecin pour subir un examen médical complet avant de commencer tout programme d'exercice, et tout particulièrement si l'utilisateur a des antécédents familiaux d'hypertension ou de troubles cardiaques, ou s'il a plus de 45 ans, s'il fume, s'il a du cholestérol, s'il est obèse ou n'a pas fait d'exercice régulièrement depuis un an. Life Fitness recommande également de consulter un professionnel du conditionnement physique pour savoir comment utiliser correctement ce produit.

Si, pendant l'utilisation de l'appareil, l'utilisateur ressent un malaise, des vertiges, des douleurs ou des difficultés à respirer, il doit s'arrêter immédiatement.

1 GETTING STARTED

1.1 IMPORTANT SAFETY INSTRUCTIONS



SAFETY WARNING: The safety of the product can be maintained only if it is examined regularly for damage and wear. See Preventative Maintenance section for details.

- To reduce the risk of electrical shock, always unplug this Life Fitness product before cleaning or attempting any maintenance activity.
- To reduce the risk of burns, fire, electric shock or injury, it is imperative to connect each product to a properly grounded electrical outlet.
- Never operate a Life Fitness product if it has a damaged power cord or electrical plug, or if it has been dropped, damaged, or even partially immersed in water. If this occurs, contact Life Fitness Customer Support Services.
- Position this product so the power cord plug is accessible to the user.
- Keep the power cord away from heated surfaces. Do not pull the equipment by the power cord or use the cord as a handle. Do not run the power cord on the floor under or along the side of the Life Fitness cross-trainer.
- If the electrical supply cord is damaged it must be replaced by the manufacturer, an authorized service agent, or a similarly qualified person to avoid a hazard.
- If this Life Fitness product does not function properly after it has been dropped, damaged, or even partially immersed in water, contact Life Fitness Customer Support Services for assistance.
- Do not use this product in areas where aerosol spray products are being used or where oxygen is being administered. Such substances create the danger of combustion and explosion.
- Always follow the console instructions for proper operation.
- Close supervision is necessary when used by children, invalids or disabled persons.

- Do not use this product outdoors, near swimming pools or in areas of high humidity.
- Never operate a Life Fitness product with the air openings blocked. Keep air openings free of lint, hair or any obstructing material.
- Never insert objects into any opening in this product. If an object should drop inside, carefully retrieve it. If the item cannot be reached, contact Life Fitness Customer Support Services.
- Never place liquids of any type directly on the unit, except in the accessory tray water bottle holder. Containers with lids are recommended.
- Wear shoes with rubber or high-traction soles. Do not use shoes with heels, leather soles, cleats or spikes. Make sure no stones are embedded in the soles.
- Keep all loose clothing, shoelaces and towels away from moving parts.
- Do not use this product with bare feet.
- Do not tip the unit on its side during operation.
- Keep the area around the Life Fitness product clear of any obstructions, including walls and furniture. Ensure that there is at least one foot of clearance in front of the unit.
- Use caution when mounting or dismounting the cross-trainer. Use the stationary handlebar whenever additional stability is required. While exercising, hold onto the moving arms.
- Never use the Life Fitness cross-trainer while facing backward.

SAVE THESE INSTRUCTIONS FOR FUTURE REFERENCE.

1.2 SETUP

Read the Operation Manual before setting up the Life Fitness cross-trainer.

WHERE TO PLACE THE LIFE FITNESS® CROSS-TRAINER

Following all safety instructions in Section 1.1, move the Life Fitness cross-trainer to the location in which it will be used. See Section 7, titled *Specifications*, for the dimensions of the footprint. Allow one foot of clearance in front of the Life Fitness cross-trainer to allow for movement of the pedal levers. It should be easy to mount the Life Fitness cross-trainer from the side.

HOW TO STABILIZE THE LIFE FITNESS CROSS-TRAINER

After placing the Life Fitness cross-trainer in position, check the unit's stability by attempting to rock it. Any slight rocking indicates that the unit must be leveled. Check the stabilizing feet to determine which foot does not rest fully on the floor. Rotate the foot counter-clockwise to lower it. Recheck the stability and adjust again as needed until the Life Fitness cross-trainer is stable and no longer rocks. **Lock the adjustment into position by tightening the jam nut against the stabilizer bar with an open end 9/16 inch wrench.**

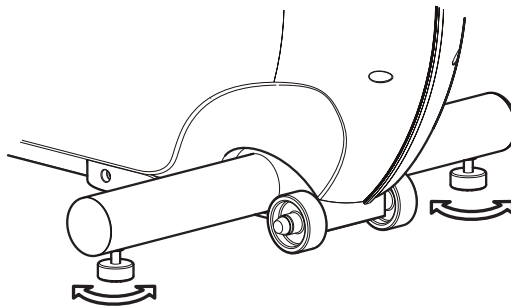

PLUG IN THE LIFE FITNESS CROSS-TRAINER

The Life Fitness cross-trainer comes with a standard power supply for the U.S., or a universal power supply that will accept country-specific line cords.

Insert the power adapter jack into the barrel plug on the back of the Life Fitness cross-trainer. Then insert the power supply into the wall outlet (A) (or the universal power supply if outside the U.S. (B)). Make sure the cord is routed so that it doesn't bind and will not be walked on.

Check that the console LEDs light up. If not, recheck the plug and wall connections and make sure the wall outlet has power.

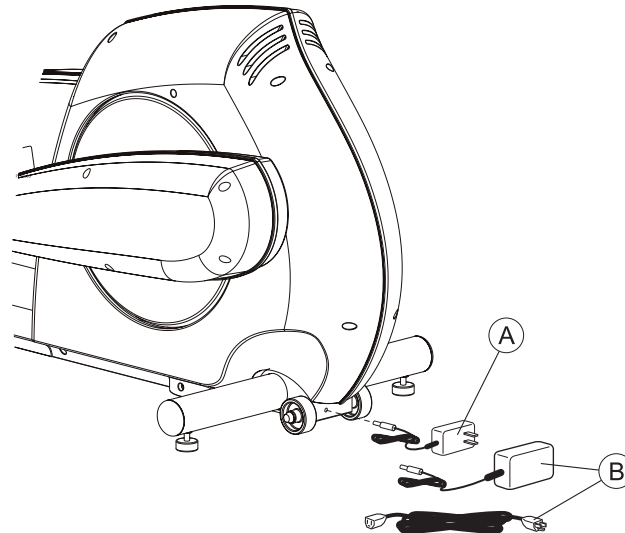

2 THE DISPLAY CONSOLE

2.1 DISPLAY CONSOLE OVERVIEW

The computerized display console on the Life Fitness cross-trainer allows the user to tailor a workout to personal fitness abilities and goals and to monitor progress. With this easy-to-use console, the user can track fitness improvement from one workout to the next.

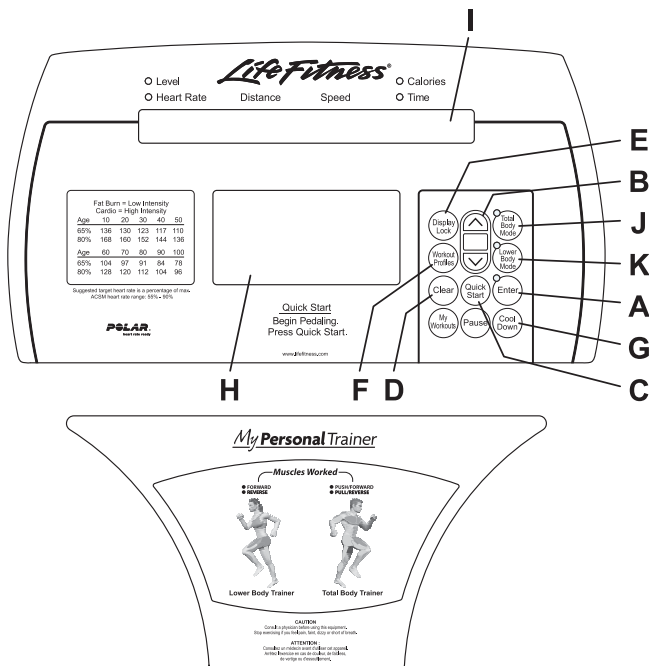

2.2 DISPLAY CONSOLE DESCRIPTIONS

This section lists and describes the functions for the keys and display windows on the console. See Section 4, titled *The Workouts*, for detailed information on using the console to set up workouts.

- A** ENTER: Press this key after entering each value, such as weight or workout time, when prompted by console display messages.
- B** ARROW KEYS: Use the UP and DOWN ARROW keys to change workout parameters displayed on the console, such as length of workout, weight, age, target heart rate, and intensity level. Pressing these keys during a **FAT BURN, CARDIO, HEART RATE HILL, HEART RATE INTERVAL,** or **EXTREME HEART RATE** workout increases or decreases the target heart rate.
- C** QUICK START: Press this key to begin a manual workout immediately, without having to select a workout program. Once the workout is in progress, use the ARROW KEYS to change the intensity level.
- D** CLEAR: Press this key, when programming a workout, to clear incorrect data, such as weight or age, before pressing the ENTER key. Pressing CLEAR during a workout stops it immediately, at which point, the MESSAGE CENTER displays a summary of the workout, including total time elapsed, total distance traveled, and total calories burned. Pressing CLEAR a second time causes the MESSAGE CENTER to prompt the user for a new workout setup.
- E** DISPLAY LOCK: During a workout, the MESSAGE CENTER alternately displays the number of CALORIES burned and the amount of TIME elapsed. Pressing the DISPLAY LOCK key when the MESSAGE CENTER displays either statistic, forces the MESSAGE CENTER to display that statistic continuously throughout the workout. Pressing DISPLAY LOCK again allows the MESSAGE CENTER to resume toggling between both statistics.
- F** WORKOUTS PROFILES: Press this key to select workout options:

- **MANUAL**
- **EZ RESISTANCE**
- **CARDIO**
- **EXTREME HEART RATE**
- **RANDOM**
- **SPORTS TRAINING**
- **HEART RATE HILL**
- **TOTAL BODY**
- **HILL**
- **FAT BURN**
- **HEART RATE INTERVAL**
- **LOWER BODY**

G COOL DOWN: workouts end automatically in a Cool Down mode, which lowers the intensity level. Press the COOL DOWN key at any desired point during a workout to go immediately into Cool Down mode. In this phase of a workout the body begins to remove lactic acid and other accumulated by-products of exercise, which build up in muscles during a workout and contribute to muscle soreness. The console automatically adjusts each workout's Cool Down level according to the individual user's performance. Each time the user presses the COOL DOWN key, the Cool Down duration shortens by one minute.

H WORKOUT PROFILE WINDOW: This window displays shapes, made of columns of lights, that represent the levels of intensity in a workout-in-progress. The height of the column is proportional to the level of the intensity.

During a **FAT BURN, CARDIO, HEART RATE HILL, HEART RATE INTERVAL,** or **EXTREME HEART RATE** workout, which requires the use of the Lifepulse system sensors or a Polar heart rate chest strap, the WORKOUT PROFILE window displays a heart shape to request the user's heart rate signal. If the console does not detect a signal, the MESSAGE CENTER displays the prompt, "NEED HEART RATE - USE TELEMETRY STRAP". If the console does not receive the signal within three minutes, the workout automatically is converted to a **MANUAL** workout.

I MESSAGE CENTER: This window displays step-by-step instructions for setting up a workout. During a workout, it displays statistics about the progress of the workout:

- **Level:** programmed intensity level. Toggles with **Heart Rate**.
- **Heart Rate:** the detected heart rate if the user is grasping Lifepulse system sensors or wearing the Polar heart rate chest strap. Toggles with **Level**. If the on-board computer does not detect a heart rate, only **Level** is displayed throughout the workout.
- **Distance:** the total distance traveled in miles (or kilometers if enabled).
- **Speed:** the pedaling speed in miles per hour.
- **Calories:** the number of calories burned since beginning the workout. Toggles with **Time**.
- **Time:** time elapsed since the start of the workout. Toggles with **Calories**.

If programmed to do so, the MESSAGE CENTER displays any or all of these three values each time the intensity level changes during the workout:

- **Calories per Hour:** the rate of calories burned per hour.
- **Watts:** effort level in Watts. The Watt is a unit of power output or the expression of the mechanical rate of work.
- **METs:** effort level in Mets. The Met is an expression of the rate of work for the human body at rest, or a metabolic equivalent; one MET is approximately equal to the metabolism of a person at rest.

Note: *The Watts display and the Calories Per Hour display cannot be turned on at the same time.*

See Section 5, titled *Optional Settings* for information about enabling the MESSAGE CENTER to display these additional settings.

J TOTAL BODY MODE: Press this key to activate a workout mode in which the MESSAGE CENTER displays prompts to vary the workload and emphasize different muscle groups during the workout. It can be used with any workout, except for **FAT BURN, CARDIO, HEART RATE HILL, HEART RATE INTERVAL, EXTREME HEART RATE,** and **EZ RESISTANCE.**

K LOWER BODY MODE: Press this key to activate a workout mode that alternates five minutes of forward motion with two minutes of reverse motion. It can be used with any workout, except for **FAT BURN, CARDIO, HEART RATE HILL, HEART RATE INTERVAL, EXTREME HEART RATE,** and **EZ RESISTANCE.**

For more information about Total Body Mode and Lower Body Mode, see the topic *Selecting a Workout Mode* in Section 4.2, titled, the *Using the Workouts.*

2.3 THE ACCESSORY TRAY / READING RACK

The accessory tray (A), which is mounted near the base of the console, provides dual storage trays with space for items such as water bottles, personal stereos, and cell phones. Additionally, an integrated reading rack (B) for supporting a book or magazine is located at the base of the upper panel of the console.

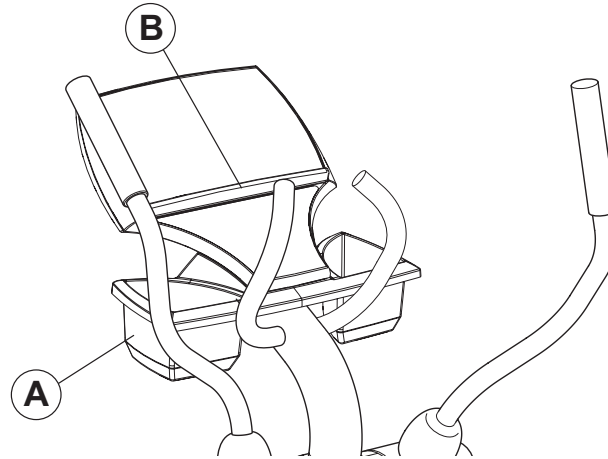

3 HEART RATE ZONE TRAINING EXERCISE

3.1 WHY HEARTSYNC™ ZONE TRAINING EXERCISE?

Research shows that maintaining a specific heart rate while exercising is the optimal way to monitor the intensity of a workout and to achieve maximum results. That is the idea behind the Life Fitness HeartSync™ zone training approach to exercise.

Zone training identifies an exerciser's ideal heart rate range, or zone, for burning fat or increasing cardiovascular fitness. The values within the zone depend on the workout.

NOTE: Consulting a fitness trainer is recommended for defining specific fitness goals and designing a workout program.

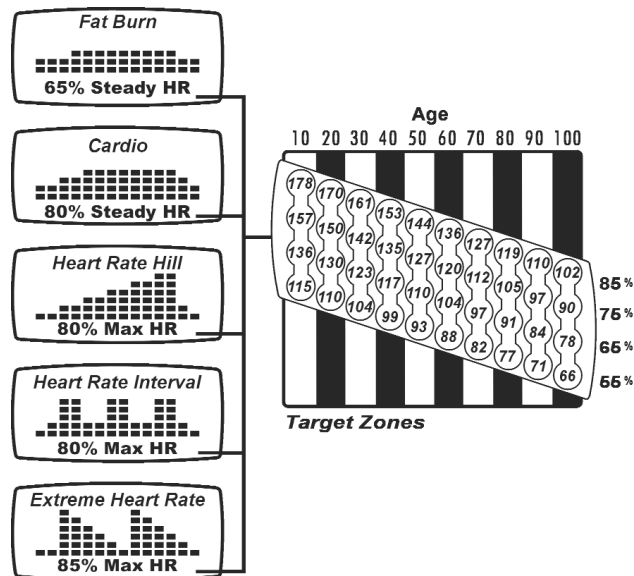

* Target Heart Rate (THR) is a percentage of the theoretical maximum. For example, a 40-year-old user's THR for the **CARDIO** workout is 144. This workout targets 80 percent of the maximum, so the equation would be $(220-40) \cdot 80 = 144$.

The Life Fitness cross-trainer features exclusive workouts designed to take full advantage of the benefits of heart rate zone training exercise: **FAT BURN, CARDIO, HEART RATE HILL, HEART RATE INTERVAL, EXTREME HEART RATE.** Each workout offers different benefits, as discussed in Section 4, titled *The Workouts*.

During one of these workouts, grasp Lifepulse system sensors, or wear the Polar heart rate chest strap to enable the on-board computer to monitor the heart rate. The computer automatically adjusts the resistance level to maintain the target heart rate* based on the actual heart rate. To change the target heart rate during a workout, use the ARROW keys.

3.2 HEART RATE MONITORING

THE LIFEPULSE™ DIGITAL HEART RATE MONITORING SYSTEM

The patented Lifepulse system sensors are the built-in heart rate monitoring system on the Life Fitness cross-trainer. For the most accurate reading possible, during a workout:

- Grasp the sensors (A) firmly.
- Hold each sensors at the vertical midpoint.
- Keep hands steady and in place.

The console displays the heart rate within 10 to 40 seconds after the user grasps the sensors.

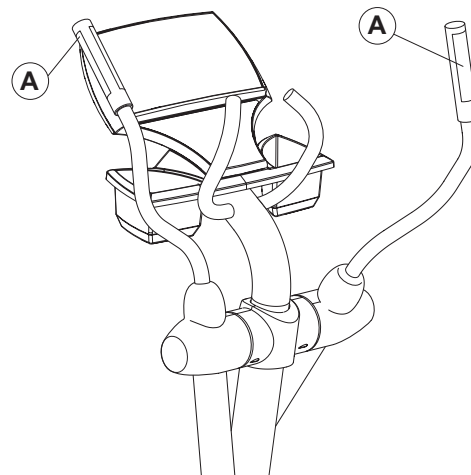

THE POLAR® TELEMETRY HEART RATE MONITORING CHEST STRAP

The Life Fitness cross-trainer is equipped with Polar telemetry, a heart rate monitoring system in which electrodes, pressed against the skin, transfer heart rate signals to the console. These electrodes are attached to a chest strap that the user wears during the workout. The chest strap is included with the Life Fitness cross-trainer.

See the diagram below for correct positioning of the strap. The electrodes (A), which are the two grooved surfaces on the underside of the strap, must remain wet to transmit accurately the electrical impulses of the heart back to the receiver. Moisten the electrodes. Then, secure the strap as high under the chest muscles as possible. The strap should be snug, but comfortable enough to allow for normal breathing.

The transmitter strap delivers an optimal heart rate reading when the electrodes are in direct contact with skin. However, it also functions properly through a thin layer of wet clothing.

If it becomes necessary to re-moisten the chest strap electrodes, grasp the center of the strap, pull it away from the chest to expose the two electrodes, and moisten them.

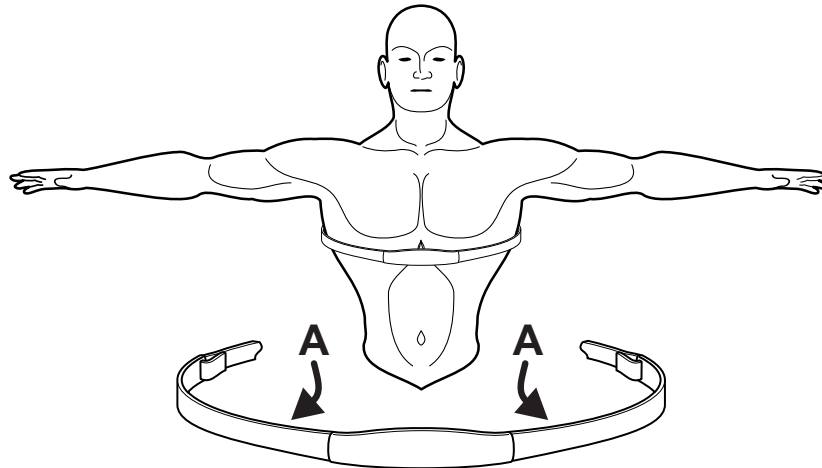

4 THE WORKOUTS

4.1 WORKOUT OVERVIEWS

This section lists the Life Fitness cross-trainer's pre-programmed workouts. For more detailed information, see Section 4.2, titled *Using the Workouts*. The following workouts are accessible via the ARROW keys.

QUICK START is the fastest way to begin exercising, and it bypasses the steps of selecting a specific workout. Once the QUICK START key is pressed, a constant-level workout begins. The intensity level does not change automatically.

MANUAL is a workout in which the intensity level does not change automatically.

RANDOM is an interval training workout of constantly changing intensity levels that occur in no regular pattern or progression.

SPORT TRAINING simulates an outdoor terrain by setting various resistance levels.

EZ RESISTANCE features a gradual, subtle increase in resistance, independent of the user's pedaling speed. A peak in resistance is followed by an equally subtle decrease in resistance.

FAT BURN is a low-intensity workout for burning the body's fat reserves. The user must grasp the Lifepulse system sensors or wear a Polar heart rate chest strap. The workout automatically adjusts the intensity level, based on the actual heart rate, to maintain the rate at 65 percent of the theoretical maximum.†

CARDIO is a higher intensity workout for more fit users, emphasizing cardiovascular benefits and maximum fat burning. The user must grasp the Lifepulse system sensors or wear a Polar heart rate chest strap. The workout automatically adjusts the intensity level, based on the actual heart rate, to maintain the rate at 80 percent of the theoretical maximum.

HEART RATE HILL consists of three hills that target three heart rate* goals: The first hill brings the heart rate to 90 percent of the target rate. The second hill increases the rate to 95 percent. The third hill matches the target rate. The valley always is defined as 85 percent of the target. The user must grasp the Lifepulse system sensors or wear a Polar heart rate chest strap.

HEART RATE INTERVAL alternates between a hill, which brings the heart rate up to the target rate, and a valley, which brings the heart rate down to 90 percent of the target. The user must grasp the Lifepulse system sensors or wear a Polar heart rate chest strap.

EXTREME HEART RATE alternates between two target heart rate goals as quickly as possible. The effect is similar to that of running sprints. The user must grasp the Lifepulse system sensors or wear a Polar heart rate chest strap.

HILL is an interval-training workout combining “hills” and “valleys” of different intensity levels, which is proven to provide effective, time-efficient cardiovascular results.

AROUND THE WORLD is an interval-training workout in which the hills resemble scenes of various geographical areas.

CASCADES is a two-peak workout in which intensity levels gradually increase and decrease.

FOOT HILLS is a rolling hill workout with low intensity levels.

INTERVAL is a Hill workout in which intensity levels rise and fall. The higher levels gradually incline toward a peak and then gradually decline.

KILIMANJARO is a Hill workout in which the intensity levels gradually incline toward one ultimate peak and then gradually decline.

SPEED TRAINING is a Hill workout in which the intensity level alternates between high and low levels very quickly to simulate a typical speed training workout.

TOTAL BODY WORKOUT simulates the experience of working with a personal trainer. The MESSAGE CENTER displays prompts at different times to emphasize pushing, pulling, total body, lower body, speed changes, and forward/reverse motion. This versatile workout promotes maximum cross-training benefits.

LOWER BODY WORKOUT continuously alternates five minutes of forward motion with two minutes of backward motion to cross-train different muscle groups.

MY WORKOUTS is not a workout program but a feature that allows the user to pre-set up to seven workouts with personal setup information, such as age or level, and then store the workouts in the console memory.

4.2 USING THE WORKOUTS

TO BEGIN A WORKOUT

To mount the Life Fitness cross-trainer, grasp the handles, and carefully step on the pedals. To dismount, step off the pedals while still holding the handles. Then, let go of the handles. Press START or simply begin pedaling to activate the console. The MESSAGE CENTER displays the prompt: "SELECT WORKOUT USING ARROW KEYS OR PRESS QUICK START". If it displays a different message, press the CLEAR key twice rapidly.

SELECTING AND USING QUICK START

QUICK START is the fastest way to begin exercising, and it bypasses the steps of selecting a specific workout program. At the MESSAGE CENTER prompt to select a workout, press the QUICK START key. The workout begins at an intensity level that remains the same unless manually changed. After 12 seconds, the MESSAGE CENTER displays a prompt to enter weight.

SELECTING A WORKOUT

For all workouts: When prompted to select a workout, use the ARROW KEYS or WORKOUT PROFILES key to scroll through the workout names as they appear in the MESSAGE CENTER. When the desired workout appears, press ENTER.

For MY WORKOUTS, once a workout is configured and saved, no further setup steps are necessary. For more information, see Section 4.4, titled *Using My Workouts Personal Programs*.

ENTERING WEIGHT

When prompted by the MESSAGE CENTER to enter weight, use the ARROW KEYS to increase or decrease the displayed weight to the correct value, and press ENTER. The default weight is 150 pounds or 68 kilograms. The on-board computer calculates the number and rate of calories burned using the entered weight as well as the pedaling RPMs.

ENTERING AGE

When prompted by the MESSAGE CENTER to enter age, use the ARROW KEYS to increase or decrease the displayed age to the correct value, and press ENTER. Workout programs that set a target* heart rate zone first calculate the user's theoretical maximum heart rate[†] by subtracting the user's age from the number 220. The programs then calculate the target zone as a percentage of the theoretical maximum.

ENTERING TIME

When prompted by the MESSAGE CENTER to enter a time, use the ARROW KEYS to increase or decrease the displayed time to the desired value, and press ENTER.

SELECTING AND ADJUSTING THE RESISTANCE LEVEL

When prompted by the MESSAGE CENTER, use the ARROW KEYS to increase or decrease the displayed intensity level or target heart rate to the desired value, and press ENTER. Adjust the level as needed or desired during the workout.

- Resistance level: The Life Fitness cross-trainer provides a selection of 20 resistance levels. The resistance level appears in the WORKOUT PROFILE window as rows of lights arranged in columns. Selecting a low intensity level at first is recommended. As physical conditioning improves, the levels can increase.
- Target heart rate: Programs that calculate a target heart rate base this number on the age of the user and the type of workout. The user accepts or adjusts the rate when setting up the workout. During the workout itself, the program reads the heart rate, which is transmitted via the Lifepulse system sensors or the Polar heart rate chest strap; and it uses this data to adjust the resistance. Manually raising the rate increases the intensity of the cardiovascular exercise.

SELECTING A WORKOUT MODE

Two workout mode options on the Life Fitness cross-trainer feature alternate ways to vary workouts.

- **Total Body Mode:** This workout mode simulates the experience of working out with a trainer. Throughout the workout, the MESSAGE CENTER displays prompts to vary the workload and emphasize different muscle groups, such as upper- and lower-body. This feature can be used with any workout, except for **FAT BURN, CARDIO, HEART RATE HILL, HEART RATE INTERVAL, EXTREME HEART RATE, and EZ RESISTANCE**. To select it, press the TOTAL BODY MODE key.
- **Lower Body Mode:** This workout mode continuously alternates five minutes of forward motion with two minutes of reverse motion, to exercise different leg muscles. This feature can be used with any workout, except for **FAT BURN, CARDIO, HEART RATE HILL, HEART RATE INTERVAL, EXTREME HEART RATE, and EZ RESISTANCE**. To select it, press the LOWER BODY MODE key.

SWITCHING WORKOUTS “ON-THE-FLY”

It is possible, during a workout, to switch to another workout program. After a switch, the console retains all the progress information about the workout since its beginning. To change workouts “on-the-fly,” press WORKOUT PROFILES key, and then select a new workout. This feature is available for all workouts, except **EZ RESISTANCE, AROUND THE WORLD, KILIMANJARO, INTERVAL, CASCADES, SPEED TRAINING, and FOOT HILLS**.

LIFE FITNESS CROSS-TRAINER WORKOUT SETUP STEPS

QUICK START

Press QUICK START
Begin workout

MANUAL

Select MANUAL
Enter weight
Enter time
Select level
Begin workout

RANDOM

Select RANDOM
Enter weight
Enter time
Select level
Begin workout

SPORT TRAINING

Select SPORT
TRAINING
Enter weight
Select time
Select level
Begin workout

EZ RESISTANCE

Select EZ RESISTANCE
Enter weight
Select time
Select level
Begin workout

FAT BURN*

Select FAT BURN
Enter weight
Enter time
Enter age
Accept THR**
Begin workout

CARDIO*

Select CARDIO
Enter weight
Enter time
Enter age
Accept THR
Begin workout

HEART RATE HILL*

Select HEART RATE HILL
Enter weight
Enter time
Enter age
Accept THR
Begin workout

HEART RATE INTERVAL*

Select HEART RATE INTERVAL
Enter weight
Enter time
Enter age
Accept THR
Begin workout

EXTREME HEART RATE*

Select EXTREME HEART RATE
Enter weight
Enter time
Enter age
Accept THR
Begin workout

HILL

Select HILL
Enter weight
Enter time
Select level
Begin workout

AROUND THE WORLD

Select AROUND THE WORLD
Enter weight
Enter time
Select level
Begin workout

* This workout requires the user to grasp the Lifepulse system sensors or wear the telemetry chest strap.

Target Heart Rate (THR) is a percentage of the theoretical maximum. For example, a 40-year-old user's THR for the **FAT BURN workout is 117. This workout targets 65 percent of the maximum, so the equation would be $(220-40) \times .65 = 117$. When the MESSAGE CENTER displays a Target Heart Rate, either accept it by pressing ENTER, or change the value with the ARROW keys, and then press ENTER.

LIFE FITNESS CROSS-TRAINER WORKOUT SETUP STEPS (CONTINUED)

CASCADES

Select CASCADES
Enter weight
Enter time
Select level
Begin workout

FOOT HILLS

Select FOOTHILLS
Enter weight
Enter time
Select level
Begin workout

INTERVAL

Select INTERVAL
Enter weight
Enter time
Select level
Begin workout

KILIMANJARO

Select KILIMANJARO
Enter weight
Enter time
Select level
Begin workout

SPEED TRAINING

Select SPEED TRAINING
Enter weight
Enter time
Select level
Begin workout

LOWER BODY WORKOUT

Select LOWER BODY WORKOUT
Enter weight
Enter time
Select level
Begin workout

TOTAL BODY WORKOUT

Select TOTAL BODY WORKOUT
Enter weight
Enter time
Select level
Begin workout

PAUSING WORKOUTS

To pause a workout, simply stop pedaling. To continue the workout, resume pedaling. The pause duration lasts 60 seconds, after which, the MESSAGE CENTER displays the prompt: "SELECT WORKOUT USING ARROW KEYS OR PRESS QUICK START".

ENDING WORKOUTS EARLY

To end a workout before the pre-set duration expires, press CLEAR once. The MESSAGE CENTER then displays a workout summary, which includes the distance travelled, the total calories burned, and other statistics. Press CLEAR a second time, and the MESSAGE CENTER displays "SELECT WORKOUT USING ARROW KEYS OR PRESS QUICK START" for a new workout.

4.3 WORKOUT DESCRIPTIONS

QUICK START

QUICK START is the fastest way to begin exercising, and it bypasses the steps of selecting a specific workout program. The intensity level for the workout is set automatically and remains the same unless manually changed. To change the level, press the UP or DOWN ARROW keys to enter a higher or lower level number. After the workout has been in progress for 12 seconds, the MESSAGE CENTER displays "ENTER WEIGHT", which the computer requires to calculate total calories. Using the ARROW KEYS, increase or decrease the displayed weight to the correct value.

MANUAL WORKOUT

The **MANUAL** program sets an intensity level that does not change automatically. While the workout is in progress, increase or lower the intensity level as desired, using the ARROW keys.

RANDOM WORKOUT

The **RANDOM** program creates a terrain of hills and valleys that varies with each workout. More than one million different patterns are possible. Because workout levels are greater in this workout than in the **HILL** workout, it is recommended that the **RANDOM** workout be set one or two levels lower than the workout level which would normally be selected in the **HILL** workout.

SPORT TRAINING™ WORKOUT

This workout sets different hills, or resistance levels, throughout the course. Each hill matches a progressive degree of difficulty. Hills last between 30 and 60 seconds, depending on the workout duration.

EZ RESISTANCE

In this workout, the gradual changes in resistance are extremely subtle, lowering perceived exertion. The changes in resistance also are independent of user's pedaling speed. The cardiovascular workout is effective, efficient, and enjoyable at the same time.

The workout consists of one hill. The user determines the height of the peak of this hill by selecting an intensity level during the setup. The higher the level selected, the higher the intensity at the entry point, which is the beginning of the workout, and the higher the intensity at the peak, which occurs after 75 percent of the workout is completed. After the peak is reached, the resistance gradually returns to the same intensity level as that of the entry point. See the chart below.

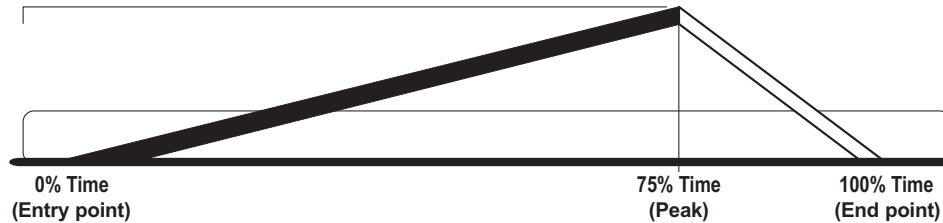

EZ Resistance Workout Profile

FAT BURN

The **FAT BURN** workout is designed to maintain a user's heart rate at 65 percent of the theoretical maximum[†] for optimal results. Throughout the workout, the user grasps the Lifepulse system sensors or wears a Polar heart rate chest strap. If the user is not wearing a chest strap, the WORKOUT PROFILE window displays a heart shape, and the MESSAGE CENTER displays a prompt to wear the chest strap. The console continuously monitors and displays the heart rate, adjusting the intensity level to reach and maintain the target*. This system eliminates over- and under-training, and it maximizes the aerobic benefits of exercise by using the body's fat stores for fuel.

CARDIO

The **CARDIO** workout is virtually identical to **FAT BURN**; however the target heart rate is calculated at 80 percent of the theoretical maximum. As with **FAT BURN**, the user grasps the Lifepulse system sensors or wears a Polar heart rate chest strap throughout the **CARDIO** workout. The higher target promotes cardiovascular improvement by placing a heavier workload on the heart muscle.

HEART RATE HILL™ WORKOUT

This program consists of three hills that target three heart rate goals: The first hill brings the heart rate to 90 percent of the target rate*. The second hill increases the rate to 95 percent. The third hill matches the target heart rate. The valley always is defined as 85 percent of the target. After a warm-up, the workout progresses toward the first hill and heart rate goal. Once the user reaches 90 percent of the target heart rate, the hill continues for one minute. When the minute expires, the level decreases into a valley. Once the user's heart rate falls to 85 percent of the target, the valley continues for one minute. Then, the next hill begins with its corresponding heart rate goal. After the user completes the third hill/valley pair, the program returns to the first hill and repeats the cycle as long as the duration allows. See the chart below. Throughout the workout, the user must grasp the Lifepulse system sensors or wear a Polar heart rate chest strap to enable the program to monitor the heart rate.

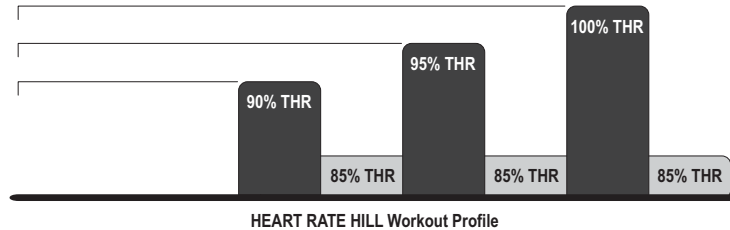

HEART RATE HILL Workout Profile

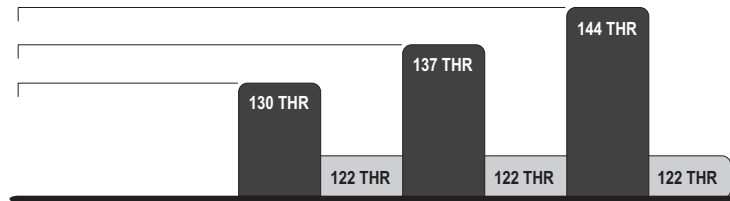

User Example 80 percent of theoretical maximum (40 year old / 144 recommended THR)

[†] Defined by the American College of Sports Medicine's "Guidelines for Exercise Testing and Prescription" as equal to 220 minus an individual's age.

* Target Heart Rate (THR) is a percentage of the theoretical maximum (HRmax). A 40-year-old user's recommended THR for the HEART RATE HILL workout is 144, or 80 percent of the maximum; so the equation would be $(220-40) \cdot 80 = 144$.

HEART RATE INTERVAL™ WORKOUT

This program alternates between a hill, which brings the heart rate up to the target rate*, and a valley, which brings the heart rate down to 90 percent of the target. After a warm-up, the workout progresses toward the first hill and heart rate goal. Once the goal is reached, the hill continues for three minutes. Then the level decreases into a valley. Once the 90 percent goal is reached, the valley continues for three minutes, after which the next hill begins. The user's fitness level determines the number of hills and valleys encountered within the duration. See the chart below. Throughout the workout, the user must grasp the Lifepulse system sensors or wear a Polar heart rate chest strap to enable the program to monitor the heart rate.

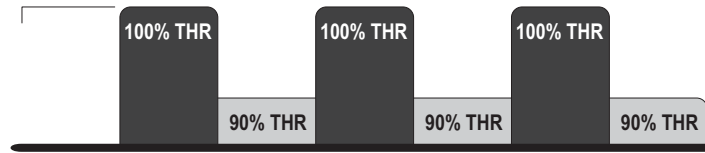

HEART RATE INTERVAL Workout Profile

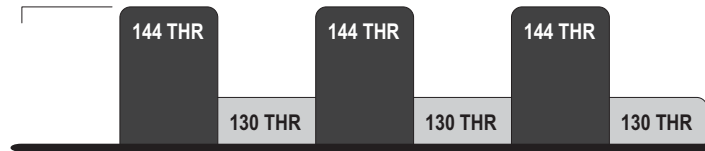

User Example 80 percent of theoretical maximum (40 year old / 144 recommended THR)

† Defined by the American College of Sports Medicine's "Guidelines for Exercise Testing and Prescription" as equal to 220 minus an individual's age.

* Target Heart Rate (THR) is a percentage of the theoretical maximum (HRmax). A 40-year-old user's recommended THR for the HEART RATE INTERVAL workout is 144, or 80 percent of the maximum; so the equation would be $(220-40) \cdot 80 = 144$.

EXTREME HEART RATE™ WORKOUT

This intense, varied workout is designed to help more experienced users to break through fitness improvement plateaus. The workout alternates between two target heart rate* goals as quickly as possible. The effect is similar to that of running sprints. When setting up the workout, the user enters a target heart rate. After a warm-up, the intensity gradually increases until the user reaches the 100 percent target heart rate (85 percent of the theoretical maximum[†]) goal. Then, that target rate is maintained for a stabilizing period. Afterward, the intensity decreases. When the heart rate falls to the 75 percent goal, it is maintained there for a stabilizing period. The program repeats the alternating of intensity levels, continuing this pattern for the duration. See the chart below. Throughout the workout, the user must grasp the Lifepulse system sensors or wear a Polar heart rate chest strap to enable the program to monitor the heart rate.

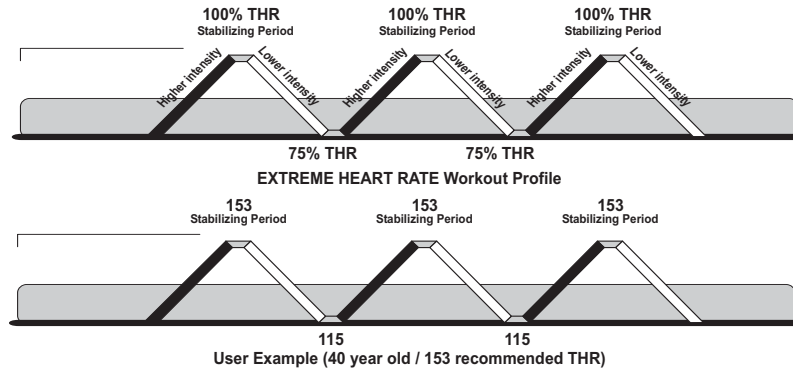

[†] Defined by the American College of Sports Medicine's "Guidelines for Exercise Testing and Prescription" as equal to 220 minus an individual's age.

* Target Heart Rate (THR) is a percentage of the theoretical maximum (HRmax). For example, a 40-year-old user's recommended THR for the EXTREME HEART RATE™ WORKOUT is 153. The workout program targets a standard 85 percent of the maximum, so the equation would be $(220 - 40) \cdot 0.85 = 153$.

HILL

The Life Fitness-patented **HILL** workout offers a variety of configurations for interval training. Intervals are periods of intense aerobic exercise separated by regular periods of lower-intensity exercise. The **WORKOUT PROFILE** window represents these high and low intervals as columns of light, which together have the appearance of hills and valleys. The computerized interval training workout has been scientifically demonstrated to promote greater cardio-respiratory improvement than steady-pace training.

Each **HILL** workout goes through four phases, each marked by different intensity levels. The **WORKOUT PROFILE** window displays the progress of these phases, as seen in the chart following these descriptions below. As noted in the descriptions, the heart rate should be measured at two stages in the workout to gauge its effectiveness. To do so, grasp the Lifepulse system sensors, or wear the Polar heart rate chest strap. The **MESSAGE CENTER** does not display a request for a heart rate measurement during a **HILL** workout.

- 1 Warm-up** is a phase of low, gradually rising resistance, which brings the heart rate into the lower end of the target zone and increases respiration and blood flow to working muscles.
- 2 Plateau** increases the intensity slightly, and keeps it steady, to bring the heart rate to the low end of the target zone. Check the heart rate at the end of this phase.
- 3 Interval Training** is a series of increasingly steeper hills, alternating with valleys, or stints of recovery. The heart rate should rise to the high end of the target* zone. Check the heart rate at the end of this phase.
- 4 Cool-down** is a low-intensity phase that allows the body to begin removing lactic acid, and other exercise by-products, which build up in muscles and contribute to soreness.

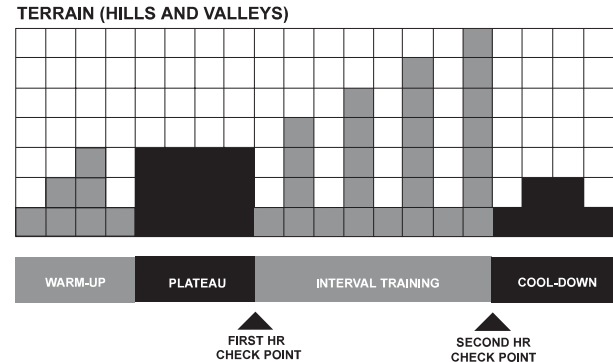

[†] Defined by the American College of Sports Medicine's "Guidelines for Exercise Testing and Prescription" as equal to 220 minus an individual's age.

* Target Heart Rate (THR) is a percentage of the theoretical maximum. For example, a 40-year-old user's THR for the **EXTREME HEART RATE** workout is 144. This workout targets 80 percent of the maximum, so the equation would be $(220-40) \cdot 80 = 144$.

Each column, as seen in the **WORKOUT PROFILE** window and the chart above, represents one interval. The overall duration of the workout determines the length of each interval. Each workout is made up of 20 intervals, so the duration of each interval is equal to the duration of the entire workout divided by 20.

1 to 9 minutes: A workout with a duration of less than 10 minutes is insufficient for the Hill program to complete all four phases adequately. The program, therefore, condenses a workout of this duration at various stages.

10 to 19 minutes: The interval durations initially are set at 30 seconds for a 10-minute workout. For every minute added by the user "on-the-fly," each interval increases by three seconds. A 15-minute workout consists of 20 intervals at 45 seconds each.

20 to 99 minutes: All intervals last 60 seconds. If the user adds minutes to the pre-set duration while the workout is in progress, the program adds hills and valleys that are identical to the first eight intervals of the Interval Training phase. This pattern repeats until the workout is completed.

SIX PRE-SET WORKOUTS

CASCADES, AROUND THE WORLD, FOOT HILLS, INTERVAL, KILIMANJARO, and **SPEED TRAINING** are variations of the **HILL** workout. These workouts cannot be changed "on-the-fly."

AROUND THE WORLD is an interval-training workout in which the hills resemble scenes of various geographical areas.

CASCADES is a two-peak workout in which intensity levels gradually increase and decrease.

FOOT HILLS is a rolling hill workout with low intensity levels.

INTERVAL is a Hill workout in which intensity levels rise and fall. The higher levels gradually incline toward a peak and then gradually decline.

KILIMANJARO is a Hill workout in which the intensity levels gradually incline toward one ultimate peak and then gradually decline.

SPEED TRAINING is a Hill workout in which the intensity level alternates between high and low levels very quickly to simulate a typical speed training workout.

TOTAL BODY WORKOUT

During this workout, the MESSAGE CENTER displays prompts to emphasize different muscle groups. To emphasize upper-body muscles, the MESSAGE CENTER displays prompts to focus on pushing and pulling the moving arms at various times. To emphasize lower-body muscles, MESSAGE CENTER displays prompts to rest the hands on the stationary handlebar, thus forcing the legs to do all the work. The program also alternates between forward and reverse motion as well as different speeds.

Ten seconds after prompting the user to change pedaling direction, the workout applies “braking resistance,” that is, a high resistance level that essentially forces the user to stop pedaling. Once the user stops pedaling, the workout resumes the normal resistance level. The actual level of braking resistance depends on the user’s pedaling RPM. If the user is pedaling at a rate equal to, or faster than, 65 RPM, the workout applies the maximum level of braking resistance. If the user is pedaling at a speed below 65 RPM, the workout applies 92 percent of the maximum.

TOTAL BODY WORKOUT is a constant-resistance workout. However, for a similar experience with a variable-resistance-level workout, the user can start any workout, except for **FAT BURN, CARDIO, HEART RATE HILL, HEART RATE INTERVAL, EXTREME HEART RATE, or EZ RESISTANCE**; and then press the TOTAL BODY MODE key.

LOWER BODY WORKOUT

During this workout, the MESSAGE CENTER displays alternating prompts to use pedal forward for five minutes and then backward motion for two minutes. This feature varies the emphasis on different leg muscles. Ten seconds after prompting the user to change pedaling direction, the workout applies “braking resistance,” that is, a high resistance level that essentially forces the user to stop pedaling. Once the user stops pedaling, the workout resumes the normal resistance level. The actual level of braking resistance depends on the user’s pedaling RPM. If the user is pedaling at a rate equal to, or faster than, 65 RPM, the workout applies the maximum level of braking resistance. If the user is pedaling at a speed below 65 RPM, the workout applies 92 percent of the maximum.

LOWER BODY WORKOUT is a constant-resistance workout. However, for a similar experience with a variable-resistance-level workout, the user can start any workout, except for **FAT BURN, CARDIO, HEART RATE HILL, HEART RATE INTERVAL, EXTREME HEART RATE, or EZ RESISTANCE**; and then press the LOWER BODY MODE key.

4.4 USING MY WORKOUTS PERSONAL PROGRAMS

The **MY WORKOUTS** personal programs feature on the Life Fitness cross-trainer makes it possible to pre-set up to seven workouts with personal setup information, such as age or duration, and then store the workouts in the console memory. MY WORKOUTS is used to store statistics for up to 7 different users or profiles. These workouts are accessed with the MY WORKOUTS key.

MY WORKOUTS allows the end-user to customize the set-up of a workout once and save it for quick start up. Any of the following workouts may be pre-set and stored: **FAT BURN, CARDIO, HEART RATE HILL, HEART RATE INTERVAL, EXTREME HEART RATE, HILL, RANDOM, MANUAL, SPORT TRAINING,** and **EZ RESISTANCE.** MY WORKOUTS allows the end-user to view workout statistics overtime applicable to each saved profile.

MY WORKOUTS - PROGRAMMING OPTIONS

Press the MY WORKOUTS key. Press the MY WORKOUTS key again to scroll through MY WORKOUTS. Press ENTER to select and start a MY WORKOUT. Press and hold the MY WORKOUTS key on the desired MY WORKOUT for editing options (this will only edit the selected MY WORKOUT). Press ENTER on one of the editing options: CHANGE NAME, CHANGE WORKOUT, or VIEW STATISTICS.

MY WORKOUTS - PROGRAMMING OPTIONS

Programmed Options	Description
NAME	Name of the user or profile, up to 16 characters
WORKOUT NAME	Choose a workout profile (ie. Random)
TIME	Duration of workout in minutes
WEIGHT	Weight of user in pounds or kilograms
AGE	Age of user in years
THR or LEVEL	Target Heart Rate for HeartSync™ workouts and resistance level for other profiles

MY WORKOUTS - PROGRAMMING THE NAME (CHANGE NAME)

Press the MY WORKOUTS key to scroll through all My Workouts. The default My Workouts names will be MY WORKOUT 1 through MY WORKOUT 7. Once the desired MY WORKOUT appears, press and hold the MY WORKOUTS key for editing options. The message center then displays USE ARROW KEYS TO SCROLL AND ENTER KEY TO SELECT EDIT OPTIONS. Scroll through the edit options by using the ARROW KEYS and press the ENTER key when CHANGE NAME appears. A name will appear with the first character blinking. To modify the first character simply press the UP or DOWN ARROW keys to scroll through all available characters. Once the desired character appears press the ENTER key to accept the character and then automatically move to the next character. When completed, press and hold the MY WORKOUTS key to save the profile name. The name will be saved and the display will return to EDIT OPTIONS.

The PAUSE/CLEAR key can be pressed at anytime to delete the current flashing character. In addition, when the first character is blinking the PAUSE/CLEAR key can be pressed to return the console to My Workouts EDIT OPTIONS.

If the PAUSE/CLEAR key is pressed while in My Workouts EDIT OPTIONS the console will return to idle mode. If no key is pressed within 30 seconds, the display will exit the programming mode and return to idle mode. No workout will be saved.

MY WORKOUTS - PROGRAMMING THE WORKOUT PROFILE (CHANGE WORKOUT)

Press the MY WORKOUTS key to scroll through all My Workouts. The default My Workouts names will be MY WORKOUT 1 through MY WORKOUT 7. Once the desired MY WORKOUT appears, press and hold the MY WORKOUTS key for editing options. The message center then displays USE ARROW KEYS TO SCROLL AND ENTER KEY TO SELECT EDIT OPTIONS. Scroll through the edit options by using the ARROW KEYS and press the ENTER key when CHANGE WORKOUT is displayed. The console will seem like it is now in normal workout set-up mode. Choose a workout and press the ENTER key. Set all other workout parameters such as time, weight, age, or target heart rate / level. If no key is pressed within 30 seconds, the display will exit the programming mode and return to idle mode. No workout will be saved.

MY WORKOUTS - VIEWING THE STATISTICS (VIEW STATISTICS)

Press the MY WORKOUTS key to scroll through all My Workouts. The default My Workouts names will be MY WORKOUT 1 through MY WORKOUT 7. Once the desired MY WORKOUT appears, press and hold the MY WORKOUTS key for editing options. The message center then displays USE ARROW KEYS TO SCROLL AND ENTER KEY TO SELECT EDIT OPTIONS. Scroll through the edit options by using the ARROW KEYS and press the ENTER key when VIEW STATISTICS is displayed. Press the ARROW KEYS to scroll through statistics including: Accumulated Time (hours), Accumulated Minutes (minutes combined with hours), Accumulated Calories, and Accumulated Distance. Press the MY WORKOUTS key at any time to exit statistics and return to My Workouts EDIT OPTIONS. If no key is pressed within 30 seconds, the display will exit the programming mode and return to idle mode. No workout will be saved.

5 OPTIONAL SETTINGS

5.1 ENTERING AND USING THE OPTIONAL SETTINGS FEATURE

Use the Optional Settings feature to change default settings, or to enable or disable certain workouts or displays on the Life Fitness cross-trainer console.

To enter the Optional Settings, while the unit is on, hold down the UP ARROW key and press CLEAR twice. The MESSAGE CENTER displays OPTIONAL SETTINGS, and then, the first configuration option. Scroll forward through the options using the ENTER key, or backward, using the CLEAR key. For each feature or setting option, the MESSAGE CENTER displays the default setting. To change the default, press the UP or DOWN ARROW key for the desired value. Press ENTER to select the new value or setting.

To exit Optional Settings, press the CLEAR key repeatedly until the MESSAGE CENTER displays "SELECT WORKOUT USING ARROW KEYS OR PRESS QUICK START".

OPTIONAL SETTINGS		
Setting	Default Value	Description
MAX WORKOUT DURATION	60 minutes	This is the maximum possible duration for a workout. The value can range from 1 to 99.
ENGLISH/METRIC UNITS	ENGLISH	This option determines the units used for entering weight and measuring distance.
WATTS DISPLAY ENABLE/ DISABLE	DISABLED	If this option is enabled, the MESSAGE CENTER displays the of Watts equivalent pedaling rate.
METS DISPLAY ENABLE/ DISABLE	DISABLED	If this option is enabled, the MESSAGE CENTER displays the Mets equivalent of the pedaling rate.
CAL/HR DISPLAY ENABLE/ DISABLE	DISABLED	If this option is enabled, the MESSAGE CENTER displays the number of calories burned per hour during the workout.

6 SERVICE AND TECHNICAL DATA

6.1 PREVENTATIVE MAINTENANCE TIPS

The Life Fitness cross-trainer is backed by the engineering excellence of Life Fitness and is one of the most rugged and trouble-free pieces of exercise equipment on the market today. Commercial Life Fitness products have proven to be durable in health clubs, colleges, and military facilities the world over. This same technology, engineering expertise, and reliability have gone into the Life Fitness cross-trainer.

NOTE: *The safety of the equipment can be maintained only if the equipment is examined regularly for damage or wear. Keep the equipment out of use until defective parts are repaired or replaced. Pay special attention to parts that are subject to wear as outlined in the Preventive Maintenance Schedule.*

REMARQUE : *pour conserver un matériel sûr, il convient de l'inspecter régulièrement afin de déceler tout signe d'usure ou d'endommagement. N'utilisez pas l'appareil tant que les pièces défectueuses n'ont pas été réparées ou remplacées. Portez une attention toute particulière aux pièces qui s'usent, comme indiqué ci-dessous.*

The following preventive maintenance tips will keep your Life Fitness cross-trainer operating at peak performance:

- Locate the Life Fitness cross-trainer in a cool, dry place.
- Clean the top surface of the pedals regularly.
- Keep the display console free of fingerprints and salt build-up caused by sweat.
- Use a 100% cotton cloth, lightly moistened with water and mild liquid detergent, to clean the Life Fitness cross-trainer. Other fabrics, including paper towels, may scratch the surface. Do not use ammonia, chlorine, or acid-based cleaners.

- Long fingernails may damage or scratch the surface of the console; use the pad of the finger to press the selection buttons on the console.
- Clean the housing and moving arms thoroughly on a regular basis.



NOTE: When cleaning the exterior of the unit, a non-abrasive cleaner and soft cotton cloth are strongly recommended. At no time should cleaner be applied directly to any part of the equipment; apply the non-abrasive cleaner on a soft cloth and then wipe the unit.

6.2 PREVENTATIVE MAINTENANCE SCHEDULE

Follow the schedule below to ensure proper operation of the product.

<i>ITEM</i>	<i>WEEKLY</i>	<i>MONTHLY</i>	<i>BI-ANNUALLY</i>	<i>ANNUALLY</i>
<i>Display Console</i>	<i>C</i>	<i>I</i>		
<i>Console Mounting Bolts</i>			<i>I</i>	
<i>Accessory Tray</i>	<i>C</i>	<i>I</i>		
<i>Frame</i>	<i>C</i>			<i>I</i>
<i>Plastic Covers</i>	<i>C</i>	<i>I</i>		

KEY: C=Clean; I=Inspect

6.3 TROUBLESHOOTING THE LIFEPULSE SYSTEM SENSORS

If the heart rate reading is erratic or missing, do the following:

- Dry the hands if necessary to prevent slipping.
- Apply hands to all four sensors; two in each hand.
- Grasp the sensors firmly.
- Apply constant pressure around the sensors.

6.4 TROUBLESHOOTING THE POLAR HEART RATE CHEST STRAP

HEART RATE READING IS ERRATIC OR ABSENT ENTIRELY

- Repeat the electrode wetting procedure. See section 3.2 titled *Heart Rate Monitoring*. The electrodes must be wet to pick up and transmit accurate heart rate readings.
- Make sure the electrodes are flat against the skin.
- Wash the belt transmitter regularly with mild soap and water.
- Make sure the chest strap transmitter is within three feet (91 centimeters) of the heart rate receiver.
- The Polar heart rate chest strap is battery operated and will eventually stop functioning. If the chest strap transmitter battery is depleted, contact Life Fitness Customer Support Services at 1-800-351-3737 for instructions on how to have the chest strap replaced.

HEART RATE READING IS ERRATIC OR EXTREMELY HIGH

When exercising with the Polar heart rate chest strap, the user may come within range of electromagnetic signals strong enough to cause abnormally elevated heart rate readings. Possible sources of such signals include

- Television sets and/or antennas, cell phones, computers, cars, high voltage power lines and motor driven exercise equipment.
- Another heart rate transmitter within three feet (91 centimeters) may also cause abnormal heart rate readings.

6.5 HOW TO OBTAIN PRODUCT SERVICE

1. Verify the symptom and review the operating instructions. The problem may be unfamiliarity with the product and its features and workouts.
2. Locate the serial number plate, which is at the back end of the unit. Document the serial number, which consists of three letters followed by six numerals.
3. Contact Life Fitness Customer Support Services via the Web at: www.lifefitness.com, or call the nearest Life Fitness Customer Support Services group:

For Product Service within
the United States and Canada:

Telephone: (+1) 847.451.0036
FAX: (+1) 847.288.3702
Toll-free telephone: 800.351.3737

For Product Service Internationally:

Life Fitness Europe GmbH
Telephone: (+49) 089.317.751.66
FAX: (+49) 089.317.751.38

Life Fitness (UK) LTD
Telephone: (+44) 1353.665507
FAX: (+44) 1353.666018

Life Fitness Atlantic BV
Life Fitness Benelux
Telephone: (+32) 03.644.44.88
FAX: (+32) 03.644.24.80
Telephone: (+32) 87.300.942
FAX: (+32) 87.300.943

Life Fitness Italia S.R.L.
Telephone: (+39) 0457.237.811
FAX: (+39) 0457.238.197

Life Fitness Vertriebs GmbH
Telephone: (+43) 1615.7198
FAX: (+43) 1615.7198.20

Life Fitness Asia Pacific Ltd
Telephone: (+852) 2891.6677
FAX: (+852) 2575.6001

*Life Fitness Latin America
and Caribbean*
Telephone: (+1) 847.288.3964
FAX: (+1) 847 288.3886

Life Fitness Brazil
Telephone: (+55) 11.7295.2217
FAX: (+55) 11.7295.2218

Life Fitness Japan
Telephone: (+81) 3.3359.4306
FAX: (+81) 3.3359.4307

Life Fitness Iberia
Telephone : (+34) 93 672 4660
FAX : (+34) 93 672 4670

7 WARRANTY INFORMATION

WHAT IS COVERED:

This Life Fitness consumer product ("Product") is warranted to be free of all defects in material and workmanship.

WHO IS COVERED:

The original purchaser or any person receiving a newly purchased Product as a gift from the original purchaser.

HOW LONG IS IT COVERED:

Residential: All electrical and mechanical components and labor are covered, after the date of purchase, as listed on the chart below.

Non-Residential: Warranty void (this Product is intended for residential use only).

WHO PAYS SHIPPING & INSURANCE FOR SERVICE:

If the Product or any warranted part must be returned to a service facility for repairs, Life Fitness will pay all shipping and insurance charges during the warranty period (within the United States only). The purchaser is responsible for shipping and insurance charges after the warranty has expired.

WHAT WE WILL DO TO CORRECT COVERED DEFECTS:

We will ship to you any new or rebuilt replacement part or component, or, at our option, replace the Product. Such replacement parts are warranted for the remaining portion of the original warranty period.

WHAT IS NOT COVERED:

Any failures or damage caused by unauthorized service, misuse, accident, negligence, improper assembly or installation, debris resulting from any construction activities in the Product's environment, rust or corrosion as a result of the Product's location, alterations or modifications without our written authorization or by failure on your part to use, operate and maintain the Product as set out in your User Manual ("Manual"). All terms of this warranty are void if this Product is moved beyond the continental borders of the United States of America (excluding Alaska, Hawaii and Canada) and are then subject to the terms provided by that country's local authorized Life Fitness Representative.

WHAT YOU MUST DO:

Retain proof of purchase (our receipt of the attached registration card assures registration of purchase information but is not required); use, operate and maintain the Product as specified in the Manual; notify Customer Service of any defect within 10 days after discovery of the defect; if instructed, return any defective part for replacement or, if necessary, the entire Product for repair. Life Fitness reserves the right to decide whether or not a product is to be returned for repair.

USER MANUAL:

It is VERY IMPORTANT THAT YOU READ THE MANUAL before operating the Product. Remember to perform the periodic maintenance requirements specified in the Manual to assure proper operation and your continued satisfaction.

PRODUCT REGISTRATION:

Register online at www.lifefitness.com/registration. Our receipt assures that your name, address and date of purchase are on file as a registered owner of the Product. Failure to return the card will not affect your rights under this warranty. Being a registered owner assures coverage in the event you lose your proof of purchase. Please retain your proof of purchase, such as your bill of sale or receipt.

HOW TO GET PARTS & SERVICE:

Simply call Customer Service at 1-800-351-3737 or (+1) 847-288-3300, Monday through Friday from 8:00 a.m. to 5:00 p.m. Central Standard Time, and tell them your name, address and the serial number of your Product (consoles and frames may have separate serial numbers). They will tell you how to get a replacement part, or, if necessary, arrange for service where your Product is located.

EXCLUSIVE WARRANTY:

THIS LIMITED WARRANTY IS IN LIEU OF ALL OTHER WARRANTIES OF ANY KIND EITHER EXPRESSED OR IMPLIED, INCLUDING BUT NOT LIMITED TO THE IMPLIED WARRANTIES OF MERCHANTABILITY AND FITNESS FOR A PARTICULAR PURPOSE, AND ALL OTHER OBLIGATIONS OR LIABILITIES ON OUR PART. We neither assume nor authorize any person to assure for us any other obligation or liability concerning the sale of this Product. Under no circumstances shall we be liable under this warranty, or otherwise, of any damage to any person or property, including any lost profits or lost savings, for any special, indirect, secondary, incidental or consequential damages of any nature arising out of the use of or inability to use this Product. Some states do not allow the exclusion or limitation of implied warranties or of liability for incidental or consequential damages, so the above limitations or exclusions may not apply to you. Warranties may vary outside the U.S. Contact Life Fitness for details.

CHANGES IN WARRANTY NOT AUTHORIZED:

No one is authorized to change, modify or extend the terms of this limited warranty.

EFFECT OF U.S. STATE LAWS:

This warranty gives you specific legal rights and you may have other rights which vary from state to state.

MODEL	LIFETIME	5 YEARS	3 YEARS	1 YEAR
Club Series	Frame	N/A	Electrical Parts & Mechanical Parts	Labor

8 SPECIFICATIONS

8.1 LIFE FITNESS CLUB SERIES ELLIPTICAL CROSS-TRAINER SPECIFICATIONS

Designed use:	Residential
Maximum user weight:	350 pounds / 160 kilograms
Power requirements:	120 volt, 1.0 amp (U.S. & Canada); 100-240 volt, 1.0 amp (outside U.S. & Canada)
Console:	
Type:	MESSAGE CENTER with ARROW keys
Displays:	Elapsed time, RPM, level, calories, heart rate, distance, calories burned per hour (when enabled), Mets (when enabled) and Watts (when enabled)
Summaries:	Total elapsed time of workout, total calories burned, total distance
Character size:	0.54 inches / 1.4 centimeters
Workouts:	Manual, Random, Hill, EZ Resistance, Sport Training, Fat Burn, Cardio, Heart Rate Hill, Heart Rate Interval, Extreme Heart Rate, Total Body, Lower Body, Around the World, Cascades, Kilimanjaro, Speed Training, Interval, Foothills, My Workouts (7 slots), Quick Start
Modes:	Total Body and Lower Body modes during all workouts except for Fat Burn, Cardio, Heart Rate Hill, Heart Rate Interval, Extreme Heart Rate, and EZ Resistance

Heart rate monitor: Lifepulse digital heart rate monitoring system sensors
Polar telemetry heart rate monitoring system
Polar heart rate chest strap

Resistance Levels: 20

Pedal speed range: 25 - 100 RPM

Drive type: Belt/alternator

Accessory Tray: Standard

Integrated Reading Rack: Standard

Color: Slate gray with red and black accents

PHYSICAL DIMENSIONS:

Length: 83 inches / 211 centimeters
Width: 28 inches / 71 centimeters
Height: 61 inches / 155 centimeters
Weight: 235 pounds / 106.5 kilograms

SHIPPING DIMENSIONS:

Length: 81.3 inches / 206.5 centimeters
Width: 29.6 inches / 75 centimeters
Height: 47 inches / 119.3 centimeters
Weight: 250 pounds / 113.4 kilograms



Life Fitness offers a full line of premier fitness equipment for the home.

TOTAL-BODY ELLIPTICAL CROSS-TRAINERS | TREADMILLS | LIFECYCLE® EXERCISE BIKES
STAIRCLIMBERS | GYM SYSTEMS

5100 N. RIVER ROAD, SCHILLER PARK, ILLINOIS 60176
LIFEFITNESS.COM

©2007 Life Fitness, a division of Brunswick Corporation. All rights reserved. Life Fitness is a registered trademark of Brunswick Corporation. M051-00K61A117 (09.07)

Free Manuals Download Website

<http://myh66.com>

<http://usermanuals.us>

<http://www.somanuals.com>

<http://www.4manuals.cc>

<http://www.manual-lib.com>

<http://www.404manual.com>

<http://www.luxmanual.com>

<http://aubethermostatmanual.com>

Golf course search by state

<http://golfingnear.com>

Email search by domain

<http://emailbydomain.com>

Auto manuals search

<http://auto.somanuals.com>

TV manuals search

<http://tv.somanuals.com>