

S SERIES

S9i Stairclimber

OPERATION MANUAL

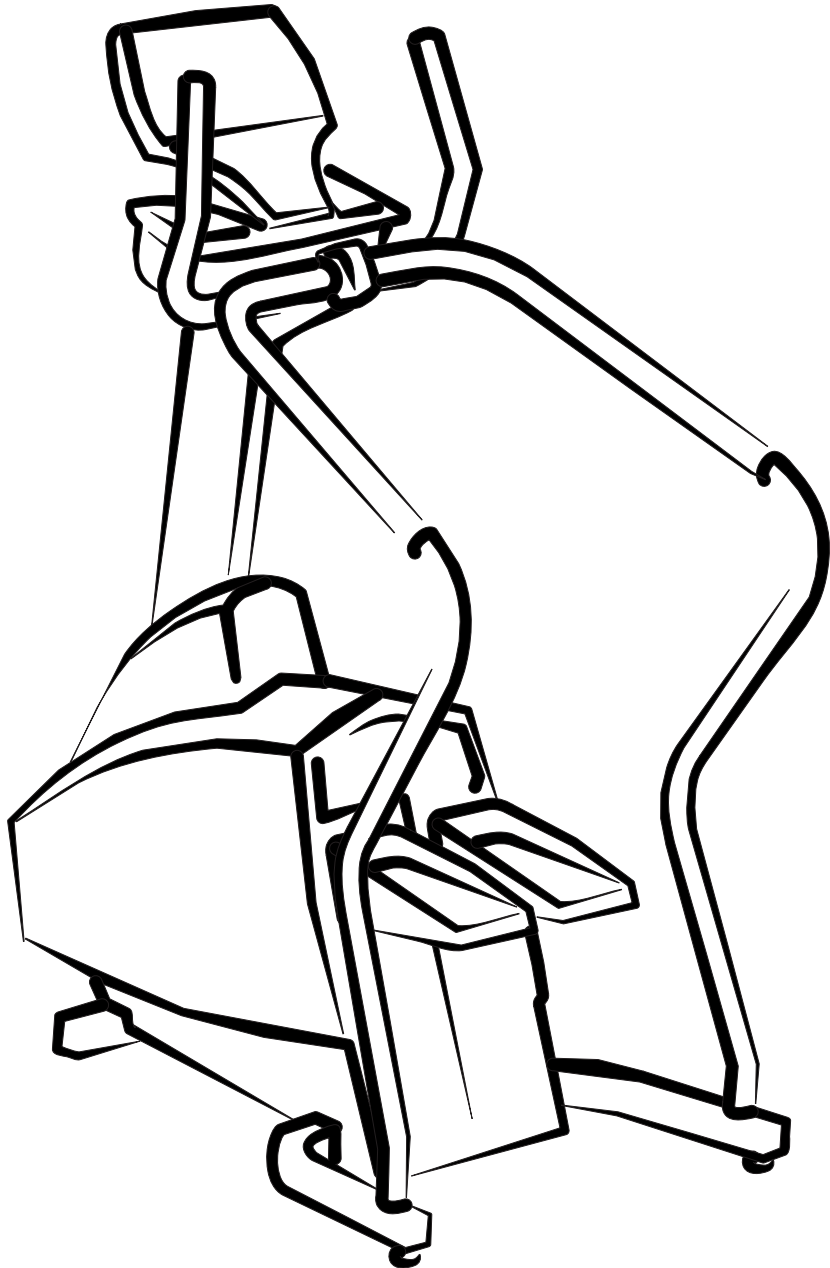

LifeFitness

CORPORATE HEADQUARTERS

10601 West Belmont Avenue
Franklin Park, Illinois 60131 • U.S.A.
847.288.3300 • FAX: 847.288.3703
800.735.3867 (Toll-free within U.S.A., Canada)

www.lifefitness.com

INTERNATIONAL OFFICES

LIFE FITNESS ASIA PACIFIC LTD

Room 2610, Miramar Tower
132 Nathan Road
Tsimshatsui, Kowloon
HONG KONG
Telephone: (+852) 2891.6677
FAX: (+852) 2575.6001

LIFE FITNESS ATLANTIC BV LIFE FITNESS BENELUX

Bijdorplein 25-31
2992 LB Barendrecht
THE NETHERLANDS
Telephone: (+31) 180.646.666
FAX: (+31) 180.646.699
Telephone: (+32) 87.300.942
FAX: (+32) 87.300.943

LIFE FITNESS DO BRAZIL

Av. Dr. Dib Sauaia Neto 1478
Alphaville, Barueri, SP
06465-140
BRAZIL
Telephone (+55) 11.4193.8282
FAX: (+55) 11.4193.8283

LIFE FITNESS VERTRIEBS GMBH

Dückerstraße 7-9/3/36
1220 Vienna
AUSTRIA
Telephone: (+43) 1.61 57 198
FAX: (+43) 1.61 57 198.20

LIFE FITNESS IBERIA

Pol. Ind. Molí dels Frares. c/C, nº 12
08620 Sant Vicenç dels Horts (Barcelona)
SPAIN
Telephone: (+34) 93.672.4660
FAX: (+34) 93.672.4670

LIFE FITNESS EUROPE GMBH

Siemensstraße 3
85716 Unterschleißheim
GERMANY
Telephone: (+49) 89.31 77 51.0
FAX: (+49) 89.31 77 51.99

LIFE FITNESS ITALIA S.R.L.

Via Vittorio Veneto, 57/A
39042 Bressanone (Bolzano)
ITALY
Telephone: (+39) 0472.835 470
FAX: (+39) 0472.833 150

LIFE FITNESS LATIN AMERICA and CARIBBEAN

10601 West Belmont Avenue
Franklin Park, Illinois 60131
U.S.A.
Telephone: (+1) 847.288.3300
FAX: (+1) 847.288.3886

LIFE FITNESS UK LTD

Queen Adelaide
Ely, Cambs CB7 4UB
UNITED KINGDOM
Telephone: (+44) 1353.666017
FAX: (+44) 1353.666018

LIFE FITNESS JAPAN

Nippon Brunswick Bldg., #8F
5-27-7 Sendagaya
Shibuya-Ku, Tokyo
JAPAN 151-0051
Telephone: (+81) 3.3359.4309
FAX: (+81) 3.3359.4307

M051-00K20-A317

4/02

Before using this product, it is essential to read this ENTIRE operation manual and ALL installation instructions.

This will help in setting up the equipment quickly and in instructing others on how to use it correctly and safely.

Avant toute utilisation de ce produit, il est indispensable de lire ce manuel d'utilisation dans son INTÉGRALITÉ, ainsi que TOUTES les instructions d'installations.

Ce manuel explique comment installer l'équipement et comment l'utiliser correctement et sans danger.

FCC Warning - Possible Radio / Television Interference

NOTE: This equipment has been tested and found to comply with the limits for a Class B digital device, pursuant to part 15 of the FCC rules. These limits are designed to provide reasonable protection against harmful interference in a residential installation. This equipment generates, uses and can radiate radio frequency energy, and if not installed and used in accordance with the operation manual, may cause harmful interference to radio communications. However, there is no guarantee that the interference will not occur in a particular installation. If this equipment does cause harmful interference to radio or television reception, which can be determined by turning the equipment off and on, the user is encouraged to try to correct the interference by one or more of the following measures:

Reorient or relocate the receiving antenna.

Increase the separation between the equipment and the receiver.

Connect the equipment into an outlet on a circuit different from that to which the receiver is connected.

Consult the dealer or an experienced radio/TV technician for help.

Class HB (Home): Domestic use.



CAUTION: Any changes or modifications to this equipment could void the product warranty.



MISE EN GARDE: Tout changement et toute modification de ce matériel peut annuler la garantie du produit.

Any service, other than cleaning or user maintenance, must be performed by an authorized service representative. There are no user-serviceable parts.

TABLE OF CONTENTS

Section	Description	Page
1.	Getting Started	5
1.1	Important Safety Instructions	5
1.2	Set-up	7
	Where to Place the Life Fitness® Stairclimber // How to Stabilize the Stairclimber // Plug In the Stairclimber // Electrical Requirement	
2.	The Display Console	9
2.1	The Display Console Overview	9
2.2	Display Console Descriptions	10
2.3	The Accessory Tray	11
2.4	The Bullhorn Handlebars (optional)	11
3.	Heart Rate Zone Training Exercise	12
3.1	Why Heart Rate Zone Training Exercise?	12
3.2	Heart Rate Monitoring	13
	The Polar® Telemetry Heart Rate Chest Strap	
4.	The Workouts	14
4.1	Workout Overviews	14
4.2	Using the Workouts	15
	To Begin any Workout // Selecting Quick Start // Selecting a Workout // Entering Weight // Entering Age // Entering Time // Selecting and Adjusting an Intensity Level // Life Fitness Stairclimber Workout Setup Steps (chart) // Switching Workouts “On-the-Fly” // Pausing Workouts // Ending Workouts Early	
4.3	Workout Descriptions	17
	Quick Start // Hill // Random // Manual // Sport Training™ Workout // EZ Resistance // Fat Burn // Cardio // Heart Rate Hill™ Workout // Heart Rate Interval™ Workout // Extreme Heart Rate™ Workout // Watts // Mets // Six Pre-Set Workouts	
4.4	My Workouts™ Personal Programs	21
	Using a Workout Saved Under My Workouts // Editing Settings for Workouts Saved Under My Workouts	
4.5	Using the Stairclimber	22
	Stairclimber Motion // Posture During Workouts // Braking Resistance	
5.	Optional Settings	23
5.1	Entering and Using the Optional Settings Feature	23
6.	Service and Technical Data	24
6.1	Preventative Maintenance Tips	24
6.2	Inspecting and Cleaning the Stairclimber	25
6.3	Troubleshooting the Polar Heart Rate Chest Strap	25
6.4	Heart Rate Reading is Erratic or Absent Entirely // Heart Rate Reading is Erratic or Extremely High	
6.5	How to Obtain Product Service	26
7.	Specifications	27
7.1	S9i Stairclimber Specifications	27

© 2002 Life Fitness, a division of Brunswick Corporation. All rights reserved. Life Fitness and Heart Rate Zone Training are registered trademarks of Brunswick Corporation. Zone Training+, Sport Training, Heart Rate Hill, Heart Rate Interval, and Extreme Heart Rate are trademarks of Brunswick Corporation. Polar is a registered trademark of Polar Electro, Inc. Any use of these trademarks, without the express written consent of Life Fitness or the corresponding companies is forbidden.

This Operation Manual describes the functions of the following products:

Life Fitness stairclimber:

S9i

See Section 7, titled *Specifications* page in this manual for product-specific features.

Statement of Purpose: The Life Fitness stairclimber is an exercise machine that simulates the movements of walking up stairs at various speeds.

 **CAUTION:** Life Fitness **STRONGLY** recommends seeing a physician for a complete medical exam before undertaking an exercise program, particularly if the user has a family history of high blood pressure or heart disease, is over the age of 45, smokes, has high cholesterol, is obese, has not exercised regularly in the past year.

If, at any time while exercising, the user experiences faintness, dizziness, pain, or shortness of breath, he or she must stop immediately.

 **MISE EN GARDE:** Life Fitness conseille **VIVEMENT** de consulter un médecin pour subir un examen médical complet avant de commencer tout programme d'exercice, et tout particulièrement si l'utilisateur a des antécédents familiaux d'hypertension ou de troubles cardiaques, ou s'il a plus de 45 ans, s'il fume, s'il a du cholestérol, s'il est obèse ou n'a pas fait d'exercice régulièrement depuis un an.

Si, pendant l'utilisation de l'appareil, l'utilisateur ressent un malaise, des vertiges, des douleurs ou des difficultés à respirer, il doit cesser immédiatement.

1 GETTING STARTED

1.1 IMPORTANT SAFETY INSTRUCTIONS



SAFETY WARNING: The safety of the product can be maintained only if it is examined regularly for damage and wear. See Preventative Maintenance section for details.

- Use this appliance only for its intended use as described in this manual. Do not use attachments that have not been recommended by the manufacturer.
- To reduce the risk of burns, fire, electric shock, or injury, it is imperative to connect each product to a properly grounded electrical outlet.
- To reduce the risk of electrical shock, always unplug this Life Fitness product before cleaning or attempting any maintenance activity.
- Position this product so that the power cord plug is accessible to the user.
- If the stairclimber has been dropped, damaged, or partially immersed in water, or if it has a damaged power cord or electrical plug, contact Life Fitness Customer Support Services and do not use the unit.
- Be very careful not to allow other people to interfere in any way with the user or equipment while their exercise routine is in progress.
- Always follow the console instructions for proper operation.
- Close supervision is necessary when used near children, invalids or disabled persons.
- Do not use the stairclimber outdoors, near swimming pools, or in areas of high humidity.
- Never insert objects into any opening in the stairclimber. If an object should drop inside, unplug the unit at the electrical outlet and carefully retrieve the object while the unit is not in use. If the object cannot be reached, contact Life Fitness Customer Support Services.
- Never place liquids of any type directly on the unit, except in an accessory tray or holder. Containers with lids are recommended.
- Wear shoes with rubber or high-traction soles. Do not use shoes with heels, leather soles, cleats, or spikes. Make sure no stones are embedded in the soles.
- Do not use this product with bare feet.
- Keep all loose clothing, shoelaces, and towels away from moving parts.
- Do not reach into, or underneath, the unit; and do not tip the unit on its side during operation.
- Keep the area around the Life Fitness stairclimber clear of any obstructions, including walls and furniture. Provide at least three feet of clearance behind the unit.
- Use caution when stepping on or off of the stairclimber.
- Never face backward while using the stairclimber.

SAVE THESE INSTRUCTIONS FOR FUTURE REFERENCE.

1 POINT DE DÉPART

1.1 CONSIGNES DE SÉCURITÉ IMPORTANTES



CONSIGNE DE SÉCURITÉ : pour un emploi sûr, le produit doit être inspecté régulièrement afin de s'assurer qu'il n'est pas usé ni endommagé. Consultez la section de Maintenance préventive pour obtenir de plus amples informations.

- Cet appareil ne doit être employé que pour l'usage auquel il est destiné, conformément aux directives de son manuel. N'utilisez pas d'accessoires qui ne seraient pas recommandés par le fabricant.
- Pour réduire les risques de brûlures, d'incendies, de décharges électriques ou de blessures, tout appareil doit être branché impérativement sur une prise électrique correctement mise à la terre.
- Pour réduire les risques de décharges électriques, l'appareil Life Fitness doit toujours être débranché avant tout nettoyage ou travail d'entretien
- Placez ce produit de manière à ce que l'utilisateur puisse accéder à la fiche du cordon d'alimentation.
- Si le marchepied d'exercice Life Fitness a subi une chute, s'il a été endommagé ou s'il est tombé dans l'eau, contactez le service clientèle de Life Fitness et n'utilisez pas l'appareil.
- Assurez-vous que personne ne gêne l'utilisateur ou ne nuise au fonctionnement de l'appareil pendant qu'il fonctionne.
- Pour un fonctionnement correct, suivez toujours les instructions de la console.
- Une surveillance étroite est nécessaire en cas d'utilisation par des enfants, des personnes invalides ou handicapées.
- N'utilisez pas ce produit à l'extérieur, près d'une piscine ou dans des endroits très humides.
- N'insérez jamais d'objet dans les ouvertures de cet appareil. Si un objet tombe dedans, coupez l'alimentation électrique, débranchez le cordon de la prise et récupérez-le avec précaution. Si vous ne pouvez pas l'atteindre, consultez le service après-vente de Life Fitness.
- Ne placez jamais de liquides d'aucune sorte directement sur l'appareil, sauf si vous disposez d'un support ou d'un plateau pour accessoires. Il est recommandé d'utiliser des verres munis d'un couvercle.
- Portez des chaussures avec semelles en caoutchouc ou antidérapantes. N'utilisez pas de chaussures à talons, de semelles en cuir ou à crampons. Assurez-vous qu'aucun caillou ne s'est incrusté dans les semelles.
- N'utilisez pas cet appareil sans chaussures.
- Maintenez les vêtements lâches, les lacets et les serviettes à l'écart des pièces en mouvement.
- Ne placez pas les mains sous ou dans l'appareil, et ne le renversez pas sur le côté pendant le fonctionnement.
- Maintenez la zone autour du produit Life Fitness exempte d'obstructions, y compris de murs et de meubles. Veillez à laisser au moins 30 cm d'espace autour du Life Fitness stairclimber.
- Procédez avec précaution lors du montage ou du démontage du Life Fitness stairclimber.
- N'utilisez jamais cet appareil en vous tournant vers l'arrière.

CONSERVEZ CES INSTRUCTIONS POUR USAGE ULTÉRIEUR.

1.2 SETUP

Read the entire Operation Manual before setting up the Life Fitness stairclimber.

WHERE TO PLACE THE LIFE FITNESS® STAIRCLIMBER

Following all safety instructions in Section 1.1, move the stairclimber to the location in which it will be used. See Section 7, titled *Specifications*, for the dimensions of the footprint. Allow a distance of 8 inches, or 21 centimeters, between the stairclimber and other units on either side. Allow a distance of 3 feet, or 1 meter, from the rear of the stairclimber to any object or surface.

HOW TO STABILIZE THE STAIRCLIMBER

After placing the stairclimber in position, check the unit's stability by attempting to rock it in all directions. Any slight rocking indicates that the unit must be leveled. Determine which foot is not resting completely on the floor. Loosen the jam nut (B) with an open-end 9/16-inch wrench, and rotate the stabilizing foot (A) to lower it. Verify that the stairclimber is stable, and repeat the adjustment as necessary until the unit no longer rocks. Lock the adjustment by tightening the jam nut against the stabilizer bar.

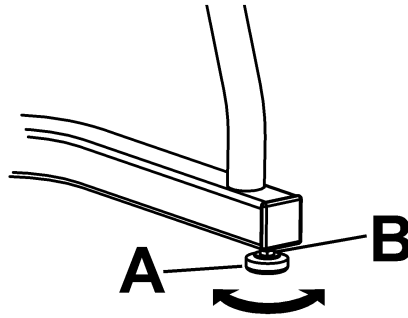

PLUG IN THE STAIRCLIMBER

The Life Fitness stairclimber comes with a standard power supply for the U.S., or a universal power supply that will accept country-specific line cords.

Insert the power adapter jack into the barrel plug at the lower front of the Life Fitness stairclimber. Then insert the power supply (A) into the wall outlet. Make sure the cord is routed so that it doesn't bind and will not be walked on.

For international models, first plug the AC power cord (C) into the adapter (B). Insert the power adapter jack into the barrel plug at the lower front of the Life Fitness stairclimber. Then insert the AC power cord (C) into the wall outlet. Make sure the cord is routed so that it doesn't bind and will not be walked on.

Check that the console LEDs light up. If not, recheck the plug and wall connections and make sure the wall outlet has power.

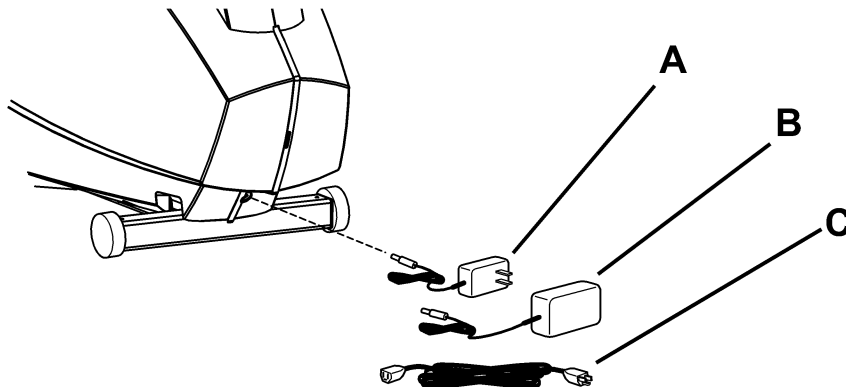

ELECTRICAL REQUIREMENT

The Life Fitness stairclimber is intended for use on a 120-volt electrical circuit in the U.S. and Canada. Consult the chart below for electrical requirements outside the U.S. and Canada. The plug must be inserted into an electrical outlet that has been properly installed and grounded in accordance with all local codes and ordinances.

Location	Voltage	Frequency Hz	Current AMPs
United Kingdom	230	50	1
Federal Republic of Germany, France, Netherlands, Italy, Chile, Belgium, Korea, Argentina, Spain	230	50	1
Latin America	110/220	60	1
Japan	200	50/60	1
Australia	240+	50	1
U.S., Canada	120	60	1

2 THE DISPLAY CONSOLE

2.1 DISPLAY CONSOLE OVERVIEW

The computerized display console on the stairclimber allows the user to tailor a workout to personal fitness abilities and goals and to monitor progress. With this easy-to-use console the user can track fitness improvement from one workout to the next.

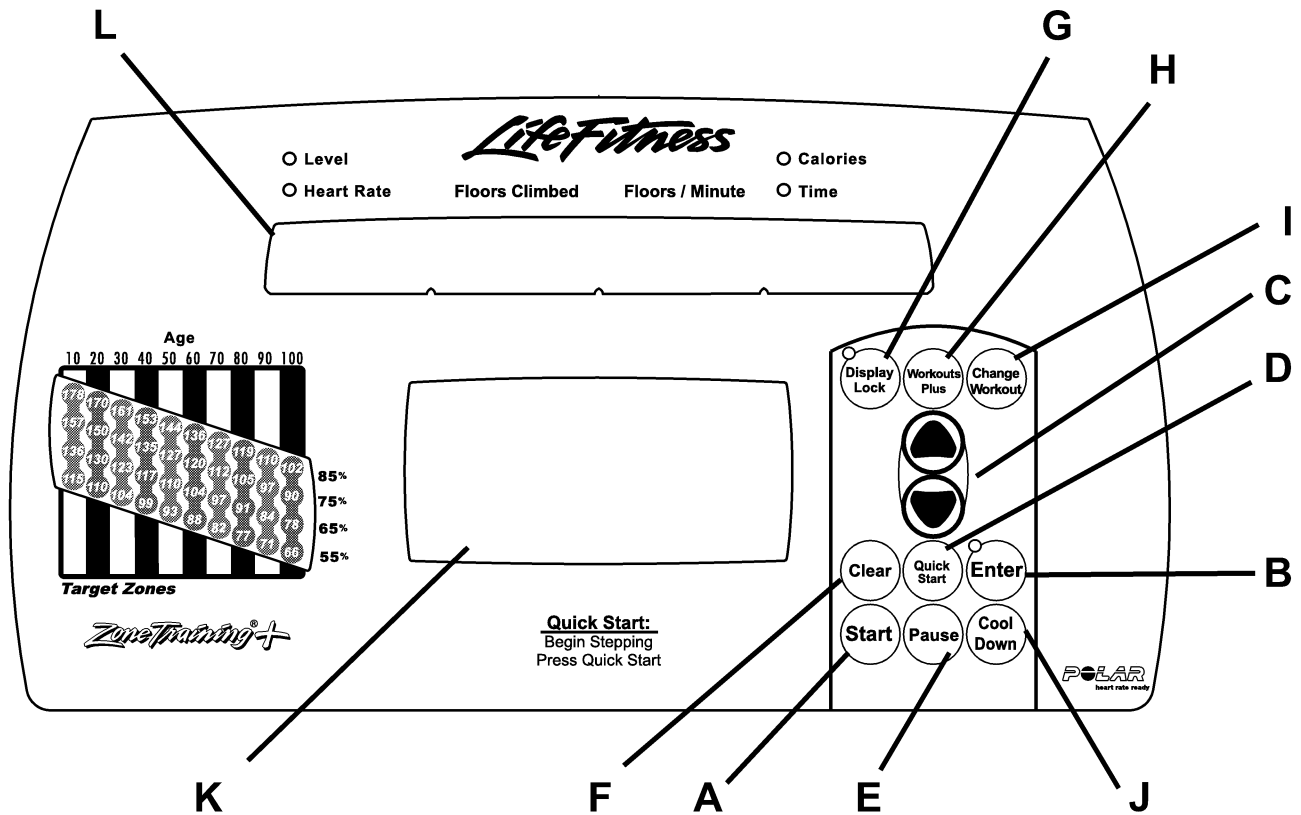

2.2 DISPLAY CONSOLE DESCRIPTIONS

The functions for the keys and display windows on the stairclimber console are listed and described in this section. See Section 4, titled *The Workouts*, for detailed information on using the console to set up workouts.

- A** **START**: Press this key to activate the console for programming a new workout. The activated console lights up and displays, "SELECT WORKOUT OR PRESS QUICK START". If no key is pressed, the console shuts down again.
- B** **ENTER**: Press this key after entering each value, such as weight or workout time, when prompted by console display messages.
- C** **ARROW** keys: Use the UP and DOWN ARROW keys to change workout parameters displayed on the console, such as length of workout, weight, age, target heart rate, and intensity level. Pressing these keys during a **FAT BURN**, **CARDIO**, **HEART RATE HILL**, **HEART RATE INTERVAL**, or **EXTREME HEART RATE** workout increases or decreases the target heart rate.
- D** **QUICK START**: Press this key to begin a **MANUAL** workout immediately, without having to select a workout. Once the workout is in progress, use the **ARROW KEYS** to change the intensity level or workout duration as desired.
- E** **PAUSE**: Press this key to pause a workout in progress. Press it again, and resume climbing to continue the workout. The workout can be paused for a maximum duration of 99 minutes. See Section 5, titled *Optional Settings*, for information on setting the maximum Pause duration. During the pause, it is possible to step off, and back on, the pedals without stopping the workout. However, if a paused workout is not resumed within the preset pause duration, the computer deletes the in-progress workout information and returns to a workout setup state: The MESSAGE CENTER displays "SELECT WORKOUT OR PRESS QUICK START".
- F** **CLEAR**: Press this key, when programming a workout, to clear incorrect data, such as weight or age, before pressing the ENTER key. Pressing CLEAR during a workout stops it immediately, at which point, the MESSAGE CENTER displays information about the workout, such as total time elapsed, total calories burned, and total floors climbed. Pressing CLEAR a second time causes the MESSAGE CENTER to prompt the user for a new workout setup.
- G** **DISPLAY LOCK**: During a workout, the MESSAGE CENTER alternately displays the number of CALORIES burned and the amount of TIME elapsed. Pressing the DISPLAY LOCK key when the MESSAGE CENTER displays either statistic, forces the MESSAGE CENTER to display that statistic continuously throughout the workout. Pressing DISPLAY LOCK again allows the MESSAGE CENTER to resume toggling between both statistics.
- H** **WORKOUTS PLUS**: Press this key to access additional workout options, such as various predetermined workout profiles and the ability to set goals based on different types of measurements. See Section 4.1, titled *Workout Overviews*, for details. The following workouts may be accessed with this key:
- **WATTS**
 - **METS**
 - **AROUND THE WORLD**
 - **KILIMANJARO**
 - **INTERVAL**
 - **CASCADES**
 - **SPEED TRAINING**
 - **FOOT HILLS**
- I** **CHANGE WORKOUT**: Press this key to switch to another workout "on the fly".
- J** **COOL DOWN**: Workouts end automatically in a Cool Down mode, which lowers the intensity level. Press the COOL DOWN key at any desired point during a workout to go immediately into Cool Down mode. In this phase of a workout the body begins to remove lactic acid and other accumulated by-products of exercise, which build up in muscles during a workout and contribute to muscle soreness. The console automatically adjusts each workout's Cool Down level according to the individual user's performance. Each time the user presses the COOL DOWN key, the Cool Down duration shortens by one minute.
- K** **WORKOUT PROFILE WINDOW**: This window displays shapes, made of columns of lights, that represent the levels of intensity in a workout-in-progress. The higher the column, the greater the intensity.
- During a **FAT BURN**, **CARDIO**, **HEART RATE HILL**, **HEART RATE INTERVAL**, or **EXTREME HEART RATE** workout, which requires the use of a Polar heart rate chest strap, the WORKOUT PROFILE WINDOW displays a flashing heart shape to request the user's heart rate signal. If the console does not detect a signal, the MESSAGE CENTER displays the prompt, "NEED HEART RATE - CHECK TELEMETRY STRAP". If the console does not receive the signal within three minutes, the workout automatically is converted to a **MANUAL** workout. Profiles are not available for **FAT BURN**, **CARDIO**, **HEART RATE HILL**, **HEART RATE INTERVAL**, or **EXTREME HEART RATE**. In these workouts, the level is based on the heart rate. Therefore, the profile cannot be displayed.

L MESSAGE CENTER: This window displays step-by-step instructions for setting up a workout. When a workout is in progress, it displays statistics about the progress of the workout, as seen below:

- **Time:** time elapsed since the start of the workout.
- **Level:** programmed intensity level.
- **Floors/Minute:** rate of floors climbed per minute.
- **Calories:** number of calories burned since beginning the workout; based on a calculation involving the entered weight of the user and the step rate. If the user does not enter weight during the workout setup, the computer does not make this calculation.
- **Heart Rate:** detected heart rate if the user is wearing the Polar heart rate chest strap.
- **Floors Climbed:** number of floors climbed since the start of the workout, based on a calculation involving the step rate.

The MESSAGE CENTER also can be programmed to display any of the following three values each time the intensity level changes during the workout. See Section 5, titled *Optional Settings*, for more information.

- **Calories per Hour:** rate of calories burned per hour.
- **Watts:** effort level in Watts. The Watt is a unit of power output or the expression of the mechanical rate of work.
- **Mets:** effort level in Mets. The Met is an expression of the rate of work for the human body, or a metabolic equivalent; one Met is approximately equal to the metabolism of a person at rest.

Note: *The Watts display and the Calories Per Hour display cannot be turned on at the same time.*

2.3 THE ACCESSORY TRAY

The accessory tray (A), which is mounted to the base of the console, provides dual storage trays with space for items such as water bottles, personal stereos, and cell phones. Additionally, an integrated reading rack (B) for supporting a book or magazine is located at the base of the upper panel of the console.

2.4 THE BULLHORN HANDLEBARS (OPTIONAL)

The optional bullhorn handlebars (C) promote good posture during workouts. By holding on to the bullhorns and standing straight while stepping, the user is less likely to off-load weight and, therefore, experiences a more beneficial workout. To order it, call Life Fitness Customer Support Services. See Section 6.4, titled *How to Obtain Product Service*. Or, contact a Life Fitness dealer.

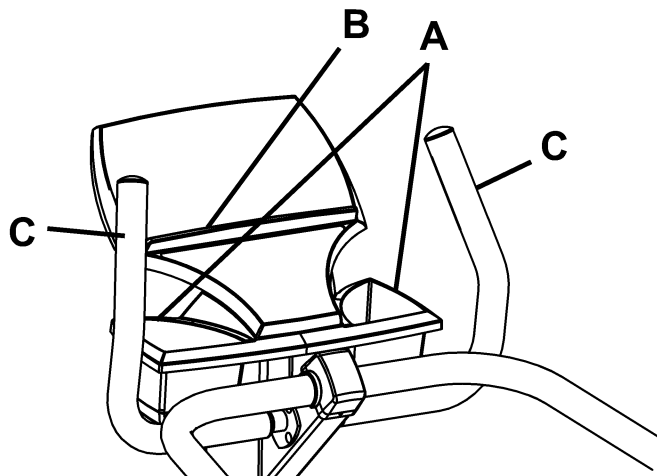

3 HEART RATE ZONE TRAINING EXERCISE

3.1 WHY HEART RATE ZONE TRAINING EXERCISE?

Research shows that maintaining a specific heart rate while exercising is the optimal way to monitor the intensity of a workout and to achieve maximum results. That is the idea behind the Life Fitness heart rate zone training approach to exercise.

Zone training identifies an exerciser's ideal heart rate range, or zone, for burning fat or increasing cardiovascular fitness. The values within the zone depend on the workout.

NOTE: Consulting a fitness trainer is recommended for defining specific fitness goals and designing a workout program.

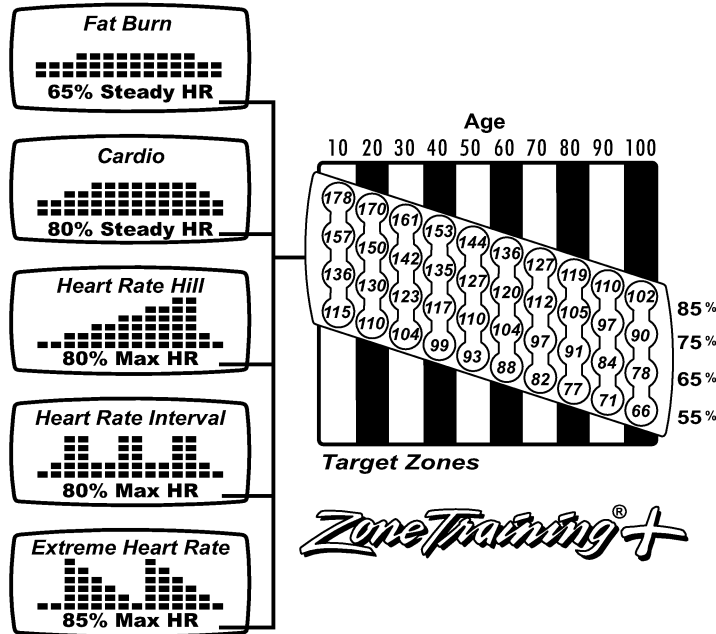

The stairclimber features five exclusive workouts designed to take full advantage of the benefits of heart rate zone training exercise: **FAT BURN**, **CARDIO**, **HEART RATE HILL**, **HEART RATE INTERVAL**, and **EXTREME HEART RATE**. For detailed information about these workouts, see Section 4, titled *The Workouts*.

During one of these workouts, wear the Polar heart rate chest strap to enable the stairclimber's on-board computer to monitor the heart rate. The computer automatically adjusts the resistance level to maintain the target heart rate* based on the actual heart rate. To change the target heart rate during a workout, use the ARROW keys.

* Target Heart Rate (THR) is a percentage of the theoretical maximum. For example, a 40-year-old user's THR for the **HEART RATE HILL** workout is 144. This workout targets 80 percent of the maximum, so the equation would be $(220-40) \cdot 80 = 144$. A 20-year-old user's THR is 160, so the equation would be $(220-20) \cdot 80 = 160$.

3.2 HEART RATE MONITORING

THE POLAR® TELEMETRY HEART RATE CHEST STRAP

The Life Fitness stairclimber is equipped with Polar telemetry, a heart rate monitoring system in which electrodes, pressed against the skin, transfer heart rate signals to the stairclimber console. These electrodes are attached to a Polar heart rate chest strap that the user wears during the workout. The chest strap is included with the stairclimber.

See the diagram below for correct positioning of the strap. The electrodes (A), which are the two grooved surfaces on the underside of the strap, must remain wet to transmit accurately the electrical impulses of the heart back to the receiver. Moisten the electrodes. Then, secure the strap as high under the chest muscles as possible. The strap should be snug, but comfortable enough to allow for normal breathing.

The transmitter strap delivers an optimal heart rate reading when the electrodes are in direct contact with skin. However, it also functions properly through a thin layer of wet clothing.

If it becomes necessary to re-moisten the chest strap electrodes, grasp the center of the strap, pull it away from the chest to expose the two electrodes, and moisten them.

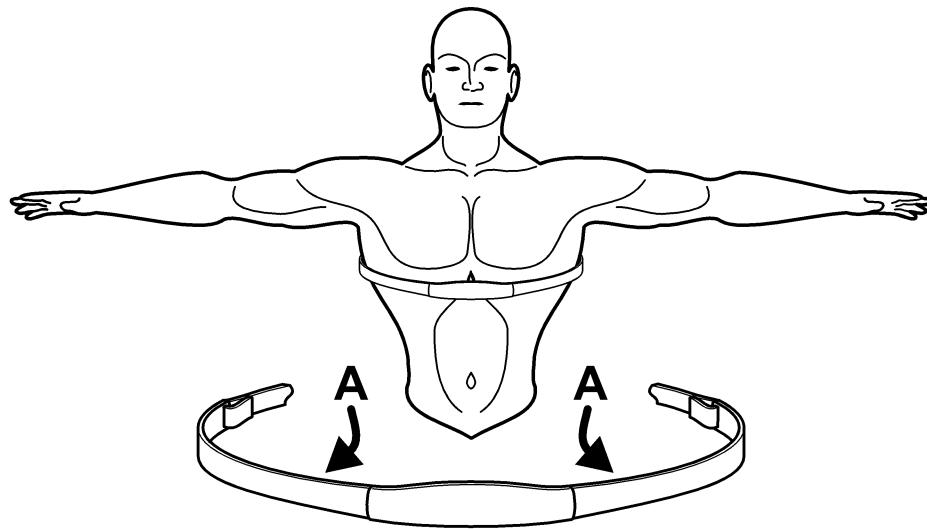

4 THE WORKOUTS

4.1 WORKOUT OVERVIEWS

This section lists the Life Fitness stairclimber pre-programmed workouts. For more detailed information, see Section 4.2, titled *Using the Workouts*.

QUICK START is the fastest way to begin exercising, and it bypasses the steps of selecting a specific workout. Once the QUICK START key is pressed, a constant-level workout begins. The intensity level does not change automatically.

HILL is an interval-training workout combining “hills” and “valleys” of different intensity levels, which is proven to provide effective, time-efficient cardiovascular results.

RANDOM is an interval training workout of constantly changing intensity levels that occur in no regular pattern or progression to challenge the user.

MANUAL is a workout in which the intensity level does not change automatically.

SPORT TRAINING simulates the experience of running up and down stairs.

EZ RESISTANCE features a gradual, subtle increase in resistance, lowering perceived exertion. A peak in resistance is followed by an equally subtle decrease in resistance.

FAT BURN is a lower-intensity workout for burning the body’s fat reserves. The user must wear a Polar heart rate chest strap. The workout automatically adjusts the intensity level, based on the actual heart rate, to maintain the rate at 65 percent of the theoretical maximum.[†]

CARDIO is a higher intensity workout for more fit users, emphasizing cardiovascular benefits and maximum fat burning. The user must wear a Polar heart rate chest strap. The workout automatically adjusts the intensity level, based on the actual heart rate, to maintain the rate at 80 percent of the theoretical maximum.

HEART RATE HILL consists of three hills that target three heart rate goals: The first hill brings the heart rate to 90 percent of the target rate*. The second hill increases the rate to 95 percent. The third hill matches the target heart rate. The valley always is defined as 85 percent of the target. The user must wear a Polar heart rate chest strap.

HEART RATE INTERVAL alternates between a hill, which brings the heart rate up to the target rate, and a valley, which brings the heart rate down to 90 percent of the target. The user must wear a Polar heart rate chest strap.

EXTREME HEART RATE alternates between two target heart rate goals as quickly as possible. The effect is similar to that of running sprints. The user must wear a Polar heart rate chest strap.

MY WORKOUTS is not a workout program but a feature that allows the user to pre-set up to seven workouts with personal setup information, such as age, time duration, or level, and then store the workouts in the console memory. These workouts are accessed with an ARROW key. See Section 4.4, titled *My Workouts Personal Programs*, for information on setting up and using these workouts.

The following workouts are accessed by pressing the WORKOUTS PLUS key :

WATTS (when enabled) targets a rate of effort equal to a certain number of Watts. A Watt is a unit of power that measures the amount of mechanical work required to operate a device, such as a stairclimber. It is roughly equal to .25 calories per hour.

METS (when enabled) targets a rate of effort equal to a certain number of Mets. A Met is a unit of measurement used to express the metabolic rate of work (oxygen consumption per unit of body weight) required to perform a task. One Met is approximately equal to a person’s metabolism when seated and relaxed.

AROUND THE WORLD is an interval-training workout in which the hills resemble scenes of various geographical areas.

KILIMANJARO is a Hill workout in which the intensity levels gradually incline toward one ultimate peak and then gradually decline.

INTERVAL is a Hill workout in which intensity levels rise and fall. The higher levels gradually incline toward a peak and then gradually decline.

[†] Defined by the American College of Sports Medicine’s “Guidelines for Exercise Testing and Prescription” as equal to 220 minus an individual’s age.

* Target Heart Rate (THR) is a percentage of the theoretical maximum. For example, a 40-year-old user’s THR for the **HEART RATE HILL** workout is 144. This workout targets 80 percent of the maximum, so the equation would be $(220-40) \cdot .80=144$. A 20-year-old user’s THR is 160, so the equation would be $(220-20) \cdot .80=160$.

CASCADES is a two-peak workout in which intensity levels gradually incline and decline.

SPEED TRAINING is a Hill workout in which the intensity level alternates between high and low levels very quickly to simulate a typical speed training workout.

FOOT HILLS is a rolling hill workout with low intensity levels.

4.2 USING THE WORKOUTS

Different workouts require different setup steps. See the chart titled *Life Fitness Stairclimber Workout Set-up Steps*, which appears later in this section, for a quick glance at the steps for setting up any workout. This section provides details on the steps themselves.

Note: A new Life Fitness stairclimber may emit a slight smell during the first few hours of operation as the load resistor heats up for the first time. If the smell persists, contact customer service.

TO BEGIN ANY WORKOUT

Press START or simply step on the pedals to activate the console. The MESSAGE CENTER displays the prompt: "SELECT WORKOUT USING ARROW KEYS OR PRESS QUICK START". If it displays a different message, press the CLEAR key twice rapidly.

SELECTING QUICK START

QUICK START is the fastest way to begin exercising, and it bypasses the steps involved in selecting a specific workout. Once **QUICK START** is selected, a constant-level workout begins. The intensity level does not change automatically.

SELECTING A WORKOUT

For **HILL, RANDOM, MANUAL, SPORT TRAINING, EZ RESISTANCE, FAT BURN, CARDIO, HEART RATE HILL, HEART RATE INTERVAL, EXTREME HEART RATE, and MY WORKOUTS**: When prompted to select a workout, use the ARROW KEYS to scroll through the workout names as they appear in the MESSAGE CENTER. When the desired workout appears, press ENTER.

For **WATTS** (when enabled), **METS** (when enabled), **AROUND THE WORLD, KILIMANJARO, INTERVAL, CASCADES, SPEED TRAINING, and FOOT HILLS**: When prompted by the MESSAGE CENTER to select a workout, press the WORKOUTS PLUS key. The MESSAGE CENTER then displays the name of one of the workouts. Press ENTER to select the displayed workout; or continue to press the WORKOUTS PLUS + key to display each of the other options, and then press ENTER to select the desired workout.

For **MY WORKOUTS**, once a workout is configured and saved, no further setup steps are necessary. For more information, see Section 4.4, titled *My Workouts Personal Programs*.

ENTERING WEIGHT

When prompted by the MESSAGE CENTER to enter weight, use the ARROW KEYS to increase or decrease the displayed weight to the correct value, and press ENTER. Stairclimber workouts calculate the number of calories burned based on the user's weight and step rate.

ENTERING AGE

When prompted by the MESSAGE CENTER to enter age, use the ARROW KEYS to increase or decrease the displayed age to the correct value, and press ENTER.

Stairclimber workouts that set a target heart rate* zone first calculate the user's theoretical maximum heart rate[†] by subtracting the user's age from the number 220. The workouts then calculate the target zone as a percentage of the theoretical maximum.

ENTERING TIME

When prompted by the MESSAGE CENTER to enter a time, use the ARROW KEYS to increase or decrease the displayed time to the desired value, and press ENTER.

[†] Defined by the American College of Sports Medicine's "Guidelines for Exercise Testing and Prescription" as equal to 220 minus an individual's age.

* Target Heart Rate (THR) is a percentage of the theoretical maximum. For example, a 40-year-old user's THR for the **HEART RATE HILL** workout is 144. This workout targets 80 percent of the maximum, so the equation would be $(220-40) \cdot 80 = 144$. A 20-year-old user's THR is 160, so the equation would be $(220-20) \cdot 80 = 160$.

SELECTING AND ADJUSTING THE INTENSITY LEVEL

When prompted by the MESSAGE CENTER, use the ARROW KEYS to increase or decrease the displayed intensity level or target heart rate* to the desired value, and press ENTER. Adjust the level as needed or desired during the workout.

- Intensity level: The Life Fitness stairclimber provides a selection of 20 intensity levels. The step speed for Level 1, the easiest setting, is two floors per minute; the tiers of difficulty increase up to Level 20, with a step rate of 13 floors per minute. The intensity level appears in the WORKOUT PROFILE window as columns of light. Selecting a low intensity level at first is recommended. As physical conditioning improves, the levels may be increased.
- Target heart rate: Stairclimber workouts that calculate a target heart rate base this number on the age of the user and the type of workout. The user accepts or adjusts the rate when setting up the workout. During the workout itself, the computer reads the heart rate, which is transmitted via the Polar heart rate chest strap; and it uses this data to adjust the resistance. Manually raising the target rate increases the intensity of the cardiovascular exercise.

* Target Heart Rate (THR) is a percentage of the theoretical maximum. For example, a 40-year-old user's THR for the **HEART RATE HILL** workout is 144. This workout targets 80 percent of the maximum, so the equation would be $(220-40) \cdot 80 = 144$. A 20-year-old user's THR is 160, so the equation would be $(220-20) \cdot 80 = 160$.

LIFE FITNESS STAIRCLIMBER WORKOUT SETUP STEPS

QUICK START

Select QUICK START
Enter weight
Begin workout

HILL

Select HILL
Enter weight
Enter time
Select intensity level
Begin workout

RANDOM

Select RANDOM
Enter weight
Enter time
Enter intensity level
Begin workout

MANUAL

Select MANUAL
Enter weight
Enter time
Enter intensity level
Begin workout

SPORT TRAINING

Select SPORT TRAINING
Select time
Enter weight
Select level
Begin workout

EZ RESISTANCE

Select EZ RESISTANCE
Select time
Enter weight
Select level
Begin workout

FAT BURN*

Select FAT BURN
Enter weight
Enter time
Enter age
Accept THR**
Begin workout

CARDIO*

Select CARDIO
Enter weight
Enter time
Enter age
Accept THR**
Begin workout

HEART RATE HILL*

Select HEART RATE HILL
Enter weight
Enter time
Enter age
Accept THR**
Begin workout

HEART RATE INTERVAL*

Select HEART RATE INTERVAL
Enter weight
Enter time
Enter age
Accept THR**
Begin workout

EXTREME HEART RATE*

Select EXTREME HEART RATE
Enter weight
Enter time
Enter age
Accept THR**
Begin workout

WATTS (if enabled)

Press WORKOUTS PLUS repeatedly until WATTS appears; press ENTER
Enter weight
Enter time
Enter Watts goal value
Begin workout

METs (if enabled)

Press WORKOUTS PLUS repeatedly until WATTS appears; press ENTER
Enter weight
Enter time
Enter Mets goal value
Begin workout

AROUND THE WORLD

Press WORKOUTS PLUS repeatedly until AROUND THE WORLD appears; press ENTER
Enter weight
Enter time
Select intensity level
Begin workout

KILIMANJARO

Press WORKOUTS PLUS repeatedly until KILIMANJARO appears; press ENTER
Enter weight
Enter time
Select intensity level
Begin workout

INTERVAL

Press WORKOUTS PLUS repeatedly until INTERVAL appears; press ENTER
Enter weight
Enter time
Select intensity level
Begin workout

CASCADES

Press WORKOUTS PLUS repeatedly until CASCADES appears; press ENTER
Enter weight
Enter time
Select intensity level
Begin workout

SPEED TRAINING

Press WORKOUTS PLUS repeatedly until SPEED TRAINING appears; press ENTER
Enter weight
Enter time
Select intensity level
Begin workout

FOOT HILLS

Press WORKOUTS PLUS repeatedly until FOOT HILLS appears; press ENTER
Enter weight
Enter time
Select intensity level
Begin workout

MY WORKOUTS

Select MY WORKOUTS
Select a workout from 1 to 7
Begin workout

* This workout requires the user to wear the telemetry chest strap.

** Target Heart Rate (THR) is a percentage of the theoretical maximum. For example, a 40-year-old user's THR for the **HEART RATE HILL** workout is 144. This workout targets 80 percent of the maximum, so the equation would be $(220-40) \cdot 80 = 144$. A 20-year-old user's THR is 160, so the equation would be $(220-20) \cdot 80 = 160$.

SWITCHING WORKOUTS “ON-THE-FLY”

It is possible, during a workout, to switch to another workout. After a switch, the console retains all the progress information about the workout since its beginning. To change workouts “on the fly,” press the CHANGE WORKOUT key. Then, using the ARROW KEYS, scroll through the workout options displayed by the MESSAGE CENTER. When the desired workout appears, press ENTER.

PAUSING WORKOUTS

To pause a workout in progress, press the PAUSE key. Press it again and resume climbing to continue the workout. The workout can be paused for a maximum duration of 99 minutes. See Section 5, titled *Optional Settings*, for information on setting the Pause duration. During the pause, it is possible to step off, and back on, the pedals without stopping the workout. However, if a paused workout is not resumed within the preset pause duration, the computer deletes the in-progress workout information and returns to a workout setup state: The MESSAGE CENTER displays “SELECT WORKOUT USING ARROW KEYS OR PRESS QUICK START”.

ENDING WORKOUTS EARLY

To end a workout before the pre-set duration expires, press CLEAR once. The MESSAGE CENTER then displays a workout summary, which includes the number of floors climbed, the total calories burned and other statistics. Press CLEAR a second time, and the MESSAGE CENTER displays SELECT WORKOUT USING ARROW KEYS OR PRESS QUICK START for a new workout.

4.3 WORKOUT DESCRIPTIONS

QUICK START

QUICK START is the fastest way to begin exercising, and it bypasses the steps of selecting a specific workout. The intensity level for the workout is set automatically and remains the same unless manually changed. To change the level press the UP or DOWN ARROW keys. If the CALORIES PER HOUR display is enabled, the MESSAGE CENTER displays ENTER WEIGHT, which is required to calculate this ratio. Using the ARROW KEYS, increase or decrease the displayed weight to the correct value.

HILL

The Life Fitness-patented **HILL** workout offers a variety of configurations for interval training. Intervals are periods of intense aerobic exercise separated by regular periods of lower-intensity exercise. The WORKOUT PROFILE window represents these high and low intervals as columns of light, which together have the appearance of hills and valleys.

The computerized interval training workout has been scientifically demonstrated to promote greater cardio-respiratory improvement than steady-pace training.

Each **HILL** workout goes through four phases, each marked by different intensity levels. The WORKOUT PROFILE window displays the progress of these phases, as seen in the chart following these descriptions below. As noted in the descriptions, the heart rate should be measured at two stages in the workout to gauge its effectiveness. To do so, wear the Polar heart rate chest strap. Note that the MESSAGE CENTER does not display a request for a heart rate measurement during a **HILL** workout.

- 1 **Warm-up** is a phase of low, gradually rising resistance, which brings the heart rate into the lower end of the target zone and increases respiration and blood flow to working muscles.
- 2 **Plateau** increases the intensity slightly, and keeps it steady, to bring the heart rate to the low end of the target zone. Check the heart rate at the end of this phase.
- 3 **Interval Training** is a series of increasingly steeper hills alternating with valleys, or stints of recovery. The heart rate should rise to the high end of the target zone. Check the heart rate at the end of this phase.
- 4 **Cool-down** is a low-intensity phase that allows the body to begin removing lactic acid and other exercise by-products, which build up in muscles and contribute to soreness.

TERRAIN (HILLS AND VALLEYS)

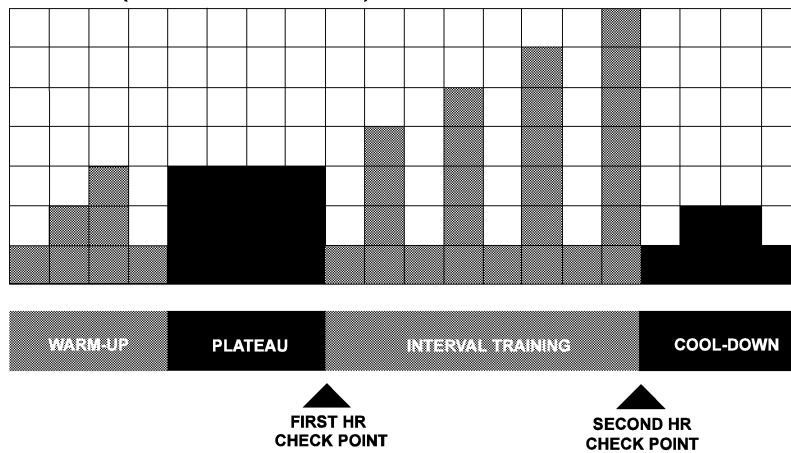

Each column, as seen in the WORKOUT PROFILE WINDOW and the chart above, represents one interval. The overall duration of the workout determines the length of each interval. Each workout is made up of 20 intervals, so the duration of each interval is equal to the duration of the entire workout divided by 20.

1 to 5 minutes: Workouts that last for these short durations have unique, short profiles with lower column heights.

6 to 19 minutes: The interval durations initially are set at 18 seconds for a six-minute workout. For every minute added by the user “on the fly,” each interval increases by three seconds. A 15-minute workout consists of 20 intervals at 45 seconds each.

20 to 99 minutes: All intervals last 60 seconds. If the user adds minutes to the pre-set duration while the workout is in progress, the workout adds hills and valleys that are identical to the first eight intervals of the Interval Training phase. This pattern repeats until the workout is completed.

RANDOM

The **RANDOM** workout creates a terrain of hills and valleys that varies with each workout. More than one million different patterns are possible.

MANUAL

The **MANUAL** workout sets an intensity level that does not change automatically. While the workout is in progress, increase or lower the intensity level as desired, using the arrow keys.

SPORT TRAINING™ WORKOUT

This workout simulates the experience of running up and down stairs by setting different hills, or intensity levels, throughout the course. Each hill matches a progressive degree of difficulty. Hills last between 30 and 60 seconds, depending on the workout duration.

EZ RESISTANCE

In this workout, the gradual changes in resistance are extremely subtle, lowering perceived exertion. The changes in resistance also are independent of the user’s stepping speed. The cardiovascular workout is effective, efficient, and enjoyable at the same time.

The workout consists of one hill. The user determines the height of the peak of this hill by selecting an intensity level during the setup. The higher the level selected, the higher the intensity at the entry point, which is the beginning of the workout, and the higher the intensity at the peak, which occurs after 75 percent of the workout is completed.

After the peak is reached, the resistance gradually returns to the same intensity level as that of the entry point. See the chart below.

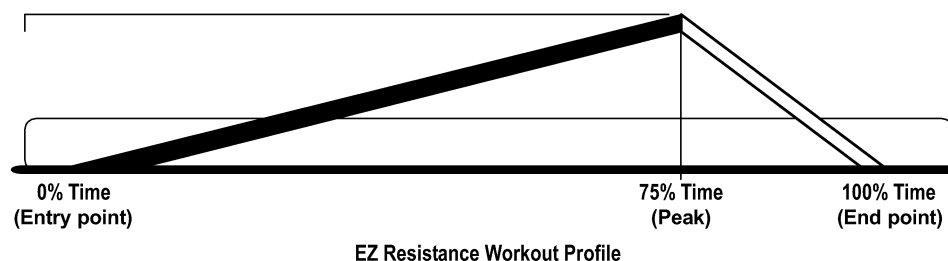

FAT BURN

The **FAT BURN** workout is designed to maintain a user's heart rate at 65 percent of the theoretical maximum rate[†] for optimal results. Throughout the workout, the user wears a Polar heart rate chest strap. The console continuously monitors and displays the heart rate, adjusting the intensity level of the Life Fitness stairclimber to reach and maintain the target*. This system eliminates over- and under-training, and it maximizes the aerobic benefits of exercise by using the body's fat stores for fuel.

CARDIO

The **CARDIO** workout is virtually identical to **FAT BURN**; however the target heart rate is calculated at 80 percent of the theoretical maximum[†]. The higher target promotes cardiovascular improvement by placing a heavier workload on the heart muscle. The user wears a Polar heart rate chest strap.

HEART RATE HILL™ WORKOUT

This workout consists of three hills that target three heart rate goals: The first hill brings the heart rate to 90 percent of the target rate. The second hill increases the rate to 95 percent. The third hill matches the target heart rate. The valley always is defined as 85 percent of the target. After a warm-up, the workout progresses toward the first hill and heart rate goal. Once the user reaches 90 percent of the target heart rate, the hill continues for one minute. When the minute expires, the level decreases into a valley. Once the user's heart rate falls to 85 percent of the target, the valley continues for one minute. Then, the next hill begins with its corresponding heart rate goal. After the user completes the third hill/valley pair, the workout returns to the first hill and repeats the cycle as long as the duration allows. See the chart below. The user must wear a Polar heart rate chest strap to enable the computer to monitor the heart rate.

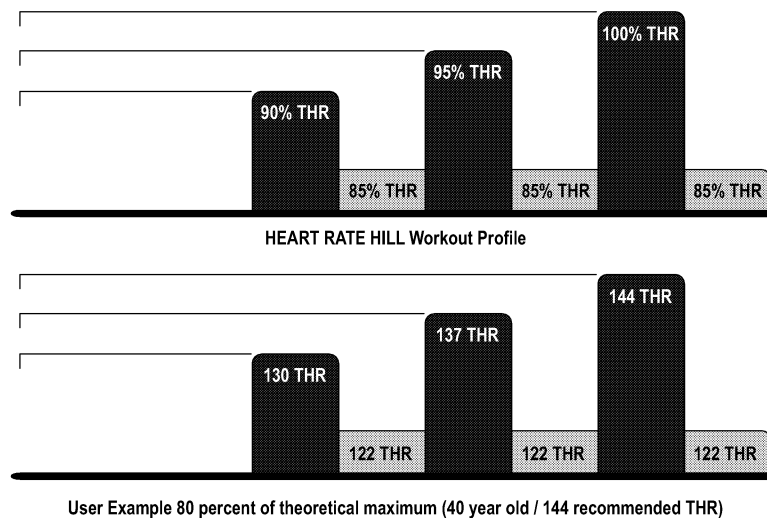

[†] Defined by the American College of Sports Medicine's "Guidelines for Exercise Testing and Prescription" as equal to 220 minus an individual's age.

* Target Heart Rate (THR) is a percentage of the theoretical maximum. For example, a 40-year-old user's THR for the **FAT BURN** workout is 117. This workout targets 65 percent of the maximum, so the equation would be $(220-40) \cdot 65=117$. A 20-year-old user's THR is 130, so the equation would be $(220-20) \cdot 65=130$.

HEART RATE INTERVAL™ WORKOUT

This workout alternates between a hill, which brings the heart rate up to the target rate*, and a valley, which brings the heart rate down to 90 percent of the target. After a warm-up, the workout progresses toward the first hill and heart rate goal. Once the goal is reached, the hill continues for three minutes. Then the level decreases into a valley. Once the 90 percent goal is reached, the valley continues for three minutes, after which the next hill begins. The user's fitness level determines the number of hills and valleys encountered within the duration. See the chart below. The user must wear a Polar heart rate chest strap to enable the computer to monitor the heart rate.

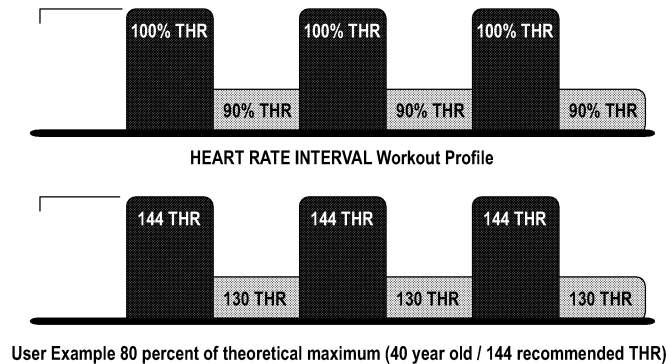

EXTREME HEART RATE™ WORKOUT

This intense, varied workout is designed to help more experienced users to break through fitness improvement plateaus. The workout alternates between two target heart rate goals as quickly as possible. The effect is similar to that of running sprints. When setting up the workout, the user enters a target heart rate. After a warm-up, the intensity gradually increases until the user reaches the 100 percent target heart rate goal. Then, that target rate is maintained for a stabilizing period. Afterward, the intensity decreases. When the heart rate falls to the 75 percent goal, it is maintained there for a stabilizing period. The program repeats the alternating of intensity levels, continuing this pattern for the duration. See the chart below. The user must wear a Polar heart rate chest strap to enable the computer to monitor the heart rate.

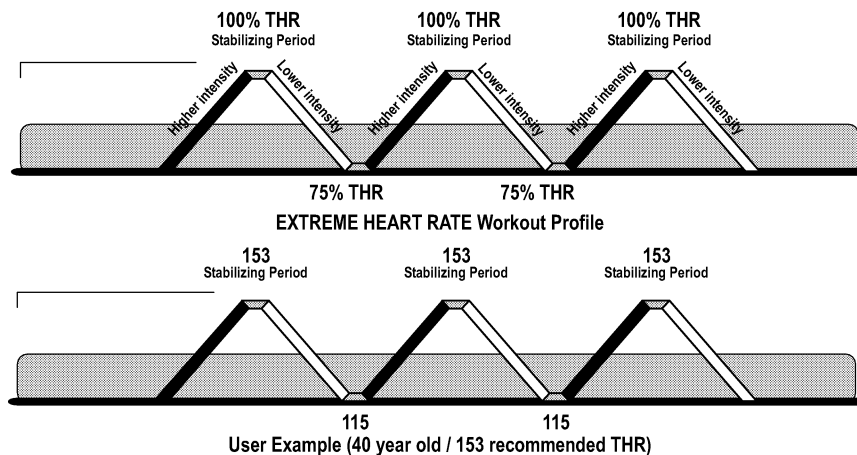

* Target Heart Rate (THR) is a percentage of the theoretical maximum. For example, a 40-year-old user's THR for the **HEART RATE INTERVAL** workout is 144. This workout targets 80 percent of the maximum, so the equation would be $(220-40) \cdot 80 = 144$. A 20-year-old user's THR is 160, so the equation would be $(220-20) \cdot 80 = 160$.

WATTS (WHEN ENABLED)

This workout targets a rate of effort equal to a certain number of Watts. A Watt is a unit of power that measures the amount of mechanical work required to operate a device, such as a stairclimber. It is roughly equal to 0.25 calories per hour. The workout automatically alters the intensity level to maintain the appropriate rate of effort. For information on enabling this workout, see Section 5, titled *Optional Settings*.

METS (WHEN ENABLED)

This workout targets a rate of effort equal to a certain number of Mets. A Met is a unit of measurement used to express the metabolic rate of work (oxygen consumption per unit of body weight) required to perform a task. The workout automatically alters the intensity level to maintain the appropriate rate of effort. For information on enabling this workout, see Section 5, titled *Optional Settings*.

SIX PRE-SET WORKOUTS

CASCADES, **AROUND THE WORLD**, **KILIMANJARO**, **INTERVAL**, **SPEED TRAINING**, and **FOOT HILLS** are variations of the **HILL** workout. These workouts cannot be changed "on the fly."

AROUND THE WORLD is an interval-training workout in which the hills resemble scenes of various geographical areas.

KILIMANJARO is a Hill workout in which the intensity levels gradually incline toward one ultimate peak and then gradually decline.

INTERVAL is a Hill workout in which intensity levels rise and fall. The higher levels gradually incline toward a peak and then gradually decline.

CASCADES is a two-peak workout in which intensity levels gradually incline and decline.

SPEED TRAINING is a Hill workout in which the intensity level alternates between high and low levels very quickly to simulate a typical speed training workout.

FOOT HILLS is a rolling hill workout with low intensity levels.

4.4 MY WORKOUTS™ PERSONAL PROGRAMS

The My Workouts Personal Programs feature on the stairclimber makes it possible to pre-set up to seven workouts with personal setup information, such as age, duration, or level, and then store the workouts in the console memory. These workouts are accessed with the ARROW keys.

Any workout can be pre-set and stored, including **FAT BURN**, **CARDIO**, **HEART RATE HILL**, **HEART RATE INTERVAL**, **EXTREME HEART RATE**, **HILL**, **RANDOM**, **MANUAL**, **SPORT TRAINING**, and **EZ RESISTANCE**.

USING A WORKOUT SAVED UNDER MY WORKOUTS

Using the ARROW keys, scroll through the workout names displayed in the MESSAGE CENTER. When the desired workout appears, press ENTER. The workout then begins.

By factory default, the workouts are stored under the names MY WORKOUT 1 through MY WORKOUT 7. Each workout must be set up before it can be accessed. See the following section for steps to set up and change workouts stored under **MY WORKOUTS**.

EDITING SETTINGS FOR WORKOUTS SAVED UNDER MY WORKOUTS

Use the following steps to change settings for a stored workout or to change a workout name.

1. When the MESSAGE CENTER displays the prompt "SELECT WORKOUT USING ARROW KEYS OR PRESS QUICK START," press the CHANGE WORKOUT key.
2. The MESSAGE CENTER displays the prompt, "WORKOUTS OPERATIONS -- SELECT USING ARROW KEYS - THEN PRESS ENTER". At this prompt, it is possible to select "CREATE/ERASE/MODIFY" to set up or change settings for a workout, "MY WORKOUT NAMING" to change a workout name, or "MY WORKOUT STATISTICS" to view statistics for a workout.
3. Scroll through the workout names displayed in the MESSAGE CENTER by pressing the ARROW keys.
4. When the desired name appears, press the ENTER key.
(To create or change a setting for a stored workout after going through Steps 1 through 4:)
5. Press ENTER to modify an existing workout, or press CLEAR to erase an existing workout.

6. If modifying a workout, enter setup information as prompted by the MESSAGE CENTER. Use the ARROW keys to scroll through displayed values, and press ENTER to confirm the desired value. Once all information is entered, the MESSAGE CENTER displays "WORKOUT SAVED".

(To change a workout name after going through Steps 1 through 4:)

5. The MESSAGE CENTER displays the prompt, "SELECT LETTER USING CHANGE WORKOUT KEY AND CHANGE LETTERS USING ARROW KEYS." The workout name appears in the MESSAGE CENTER, with the first letter blinking. Scroll to the desired letter, number, or punctuation symbol, using the arrow key. When the desired character appears, press CHANGE WORKOUT to move on to the next letter. Repeat this step for all characters.
6. Press ENTER to save the new name. The MESSAGE CENTER displays, "USER NAME SAVED."

(To view statistics for a stored workout after going through Steps 1 through 4:)

5. Select "VIEW STATISTICS", and press ENTER.
6. Scroll through the statistic displays by pressing the ARROW keys.
7. Press ENTER or CLEAR to return to the MY WORKOUTS menu.

4.5 USING THE LIFE FITNESS STAIRCLIMBER

STAIRCLIMBER MOTION

The Life Fitness stairclimber permits a maximum stepping height of 13.5 inches, or 34.3 centimeters. The unit features independent stepping action, which means that the pedals move independently of each other. Benefits of this feature include:

- Pull-push hip and knee action, which simulates actual stair climbing
- Development of greater muscular strength and endurance
- Optimal muscular development for the right leg and left leg individually
- Better cardiovascular exercise

POSTURE DURING WORKOUTS

Begin stepping at a comfortable pace, taking either full or short steps, and keeping the back straight. Hold the handrails or the optional bullhorns for stability and balance only. It should be noted that using the handrails for support can offload weight and cause the Life Fitness stairclimber console to give inaccurate readings of calories burned.

BRAKING RESISTANCE

The Life Fitness stairclimber features speed-dependent braking resistance. During a workout, the computer monitors the user's step rate and maintains it at the rate that corresponds to the selected intensity level. If the user's speed exceeds the corresponding rate, the computer increases the resistance to lower the user's speed. If the user's step rate is slower, the computer decreases the resistance to enable the user to increase speed.

5 OPTIONAL SETTINGS

5.1 ENTERING AND USING THE OPTIONAL SETTINGS FEATURE

Use the Optional Settings feature to change default settings, or to enable or disable certain programs or displays on the stairclimber console.

To enter the Optional Settings, while the unit is on, hold down the UP ARROW key, and press CLEAR twice. The MESSAGE CENTER displays a program version number. Press the ENTER key. The MESSAGE CENTER displays "OPTIONAL SETTINGS". Scroll forward through the options using the ENTER key, or backward, using the CLEAR key. For each feature or setting option, the MESSAGE CENTER displays the default setting. To change the default, press the UP or DOWN ARROW key for the desired value. Press ENTER to select the new value or setting and proceed to the next setting.

To exit Optional Settings, press the CLEAR key repeatedly until the MESSAGE CENTER displays SELECT WORKOUT OR PRESS QUICK START. Or, after the last setting has been displayed and it is impossible to scroll forward by pressing ENTER, hold down the QUICK START key, and press CLEAR. The MESSAGE CENTER then displays the prompt to select a workout.

OPTIONAL SETTINGS		
Setting	Default Value	Description
MAX WORKOUT DURATION	99 minutes	This is the maximum possible duration for a workout. The value can range from 1 to 99.
SLEEP TIME	OFF	This is the duration allowed before the console of an unused stairclimber powers down into sleep mode. In this mode, only one red LED remains illuminated in the WORKOUT PROFILE window. The range is 0 to 99 minutes. This feature cuts down on power usage.
PAUSE TIME	5 minutes	This is the duration allowed for a workout to be in pause mode. The value can range from 1 to 99. After Pause time expires, the current workout information is lost, and the console returns to the initial workout setup state, prompting the user to select a workout.
ENGLISH/METRIC UNITS	ENGLISH* METRIC**	This option determines the units of weight measurement used by workouts.
WATTS DISPLAY ENABLE/ DISABLE	DISABLED* ENABLED**	If this option is enabled, the MESSAGE CENTER displays the Watts equivalent of the step rate.
METS DISPLAY ENABLE/ DISABLE	DISABLED* DISABLED**	If this option is enabled, the MESSAGE CENTER displays the Mets equivalent of the step rate.
WATTS PROGRAM ENABLE/ DISABLE	DISABLED* ENABLED**	If this option is enabled, the Watts workout becomes an available workout on the stairclimber.
METS PROGRAM ENABLE/ DISABLE	DISABLED* DISABLED**	If this option is enabled, the Mets workout becomes an available workout on the stairclimber.
CAL/HR DISPLAY ENABLE/ DISABLE	ENABLED* DISABLED**	If this option is enabled, the MESSAGE CENTER displays the number of calories burned per hour during the workout.

*Applies to units programmed to perform measurements in English system.
**Applies to units programmed to perform measurements in Metric system.

6 SERVICE AND TECHNICAL DATA

6.1 PREVENTATIVE MAINTENANCE TIPS

The Life Fitness stairclimber is backed by the engineering excellence of Life Fitness and is one of the most rugged and trouble-free pieces of exercise equipment on the market today. Life Fitness products have proven to be durable in health clubs, colleges, military facilities, and other locations the world over. This same technology, engineering expertise, and reliability have gone into the Life Fitness stairclimber.

NOTE: *The safety of the equipment can be maintained only if the equipment is examined regularly for damage or wear. If maintenance is required, keep the equipment out of use until defective parts are repaired or replaced. Pay special attention to parts that are subject to wear as outlined in the Preventive Maintenance Schedule.*

REMARQUE : *pour conserver un matériel sûr, il convient de l'inspecter régulièrement afin de déceler tout signe d'usure ou d'endommagement. N'utilisez pas l'appareil tant que les pièces défectueuses n'ont pas été réparées ou remplacées. Portez une attention toute particulière aux pièces qui s'usent, comme indiqué ci-dessous.*

The following preventive maintenance tips will keep the Life Fitness stairclimber operating at peak performance:

- Locate the Life Fitness stairclimber in a cool, dry place.
- Clean the top surface of the pedals regularly.
- Keep the display console free of fingerprints and salt build-up caused by sweat.
- Use a **100% cotton cloth**, lightly moistened with water and mild liquid cleaning product, to clean the stairclimber. Other fabrics, including paper towels, may scratch the surface. **Do not use ammonia or acid-based cleaners.**
- Long fingernails may damage or scratch the surface of the console; use the pad of the finger to press the selection buttons on the console.
- Clean the housing thoroughly on a regular basis.

NOTE: *A non-abrasive cleaner and soft cotton cloth are strongly recommended for cleaning the exterior of the unit. At no time should cleaner be applied directly to any part of the equipment; apply the non-abrasive cleaner on a soft cloth, and then wipe the unit.*

6.2 INSPECTING AND CLEANING THE STAIRCLIMBER

Follow the schedule below to ensure proper operation of the product.

Follow the schedule below to ensure proper operation of the product.				
ITEM	WEEKLY	MONTHLY	BI-ANNUALLY	ANNUALLY
<i>Display Console</i>	C	I		
<i>Console Mounting Bolts</i>			I	
<i>Accessory Tray</i>	C	I		
<i>Frame</i>	C			I
<i>Plastic Covers</i>	C	I		

KEY: C=Clean; I=Inspect

6.3 TROUBLESHOOTING THE POLAR HEART RATE CHEST STRAP

HEART RATE READING IS ERRATIC OR ABSENT ENTIRELY

- Repeat the electrode moistening procedure on the chest strap. See Section 3.2, titled *Heart Rate Monitoring* for details. The electrodes must remain wet to pick up and transmit accurate heart rate readings.
- Make sure the electrodes are flat against the skin.
- Wash the belt transmitter regularly with mild soap and water.
- Make sure the chest strap transmitter is within three feet (91 centimeters) of the heart rate receiver.
- The chest strap is battery-operated and will stop functioning when the battery runs out. Contact Life Fitness Customer Support Services for instructions on how to have the chest strap replaced. See Section 6.4, titled *How to Obtain Product Service*.

HEART RATE READING IS ERRATIC OR EXTREMELY HIGH

If the chest strap is worn near sources of electromagnetic signals, these signals may be strong enough to elevate heart rate readings. Possible sources include:

- Television sets and/or antennas, cell phones, computers, cars, high voltage power lines and motor driven exercise equipment.
- Another heart rate transmitter within three feet, or one meter, may also cause abnormal heart rate readings.

6.5 HOW TO OBTAIN PRODUCT SERVICE

1. Verify the symptom and review the operating instructions. The problem may be unfamiliarity with the product and its features and workouts.
2. Locate and document the serial number of the unit. This number consists of three letters followed by six numbers. The serial number plate is located at the back end of the unit.

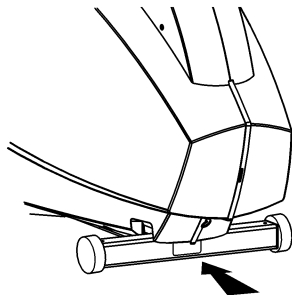

3. Contact Life Fitness Customer Support Services via the Web at: www.lifefitness.com, or call the nearest Life Fitness Customer Support Services group:

For Product Service within
the United States and Canada:

Telephone: (+1) 847.451.0036
FAX: (+1) 847.288.3702
Toll-free telephone: 800.351.3737

For Product Service Internationally:

Life Fitness Europe GmbH
Telephone: (+49) 089.317.751.66
FAX: (+49) 089.317.751.38

Life Fitness (UK) LTD
Telephone: (+44) 1353.665507
FAX: (+44) 1353.666018

Life Fitness Atlantic BV
Life Fitness Benelux
Telephone: (+32) 03.644.44.88
FAX: (+32) 03.644.24.80
Telephone: (+32) 87.300.942
FAX: (+32) 87.300.943

Life Fitness Italia S.R.L.
Telephone: (+39) 0472.835.470
FAX: (+39) 0472.833.150
Toll-free telephone: 800.438836

Life Fitness Vertriebs GmbH
Telephone: (+43) 1615.7198
FAX: (+43) 1615.7198.20

Life Fitness Asia Pacific Ltd
Telephone: (+852) 2891.6677
FAX: (+852) 2575.6001

*Life Fitness Latin America
and Caribbean*
Telephone: (+1) 847.288.3964
FAX: (+1) 847.288.3886

Life Fitness Brazil
Telephone: (+55) 11.7295.2217
FAX: (+55) 11.7295.2218

Life Fitness Japan
Telephone: (+81) 3.3359.4306
FAX: (+81) 3.3359.4307

Life Fitness Iberia
Telephone : (+34) 93 672 4660
FAX : (+34) 93 672 4670

7 SPECIFICATIONS

7.1 S9i STAIRCLIMBER SPECIFICATIONS

Designed use:	Consumer
Maximum user weight:	350 pounds / 159 kilograms
Minimum user weight:	100 pounds / 45.3 kilograms
CONSOLE:	
Displays:	MESSAGE CENTER with heart rate, floors climbed, floors per minute, level, time, calories, calories per hour (when enabled), Watts (when enabled), and Mets (when enabled) WORKOUT PROFILE
Summaries:	Total elapsed time of workout, total calories burned, total floors climbed
WORKOUTS:	Quick Start, Hill, Random, Manual, Sport Training, EZ Resistance, Fat Burn, Cardio, Heart Rate Hill, Heart Rate Interval, Extreme Heart Rate, Around the World, Kilimanjaro, Interval, Cascades, Speed Training, Foot Hills, Watts (when enabled), Mets (when enabled), My Workouts Personal Programs (7 slots)
Heart rate monitor:	Polar telemetry heart rate monitoring system Polar telemetry heart rate monitoring chest strap included
Intensity levels:	20
Stepping speed range	2 - 13 floors per minute
Pedal size	6 inches x 11 inches / 15.2 centimeters x 27.9 centimeters
Maximum step height	13.5 inches / 34.3 centimeters
Drive type:	Belt/alternator
Power requirements:	All major voltage configurations available
Accessory Tray:	Standard
Bullhorns:	Optional
Color:	Consumer gray
ASSEMBLED DIMENSIONS:	
Length	48 inches / 122 centimeters
Width	32 inches / 81.2 centimeters
Height	64 inches / 162.6 centimeters
Weight	155 pounds / 70.3 kilograms
SHIPPING DIMENSIONS:	
Length	52 inches / 132 centimeters
Width	37 inches / 94 centimeters
Height	32 inches / 81 centimeters
Weight	191 pounds / 86.6 kilograms

LifeFitness

10601 West Belmont Avenue
Franklin Park, Illinois 60131 o U.S.A.
847.288.3300 o FAX: 847.288.3703
800.735.3867 (Toll-free within U.S.A., Canada)

Free Manuals Download Website

<http://myh66.com>

<http://usermanuals.us>

<http://www.somanuals.com>

<http://www.4manuals.cc>

<http://www.manual-lib.com>

<http://www.404manual.com>

<http://www.luxmanual.com>

<http://aubethermostatmanual.com>

Golf course search by state

<http://golfingnear.com>

Email search by domain

<http://emailbydomain.com>

Auto manuals search

<http://auto.somanuals.com>

TV manuals search

<http://tv.somanuals.com>