

LifeFitness

95T-XXXXX-01 Treadmill

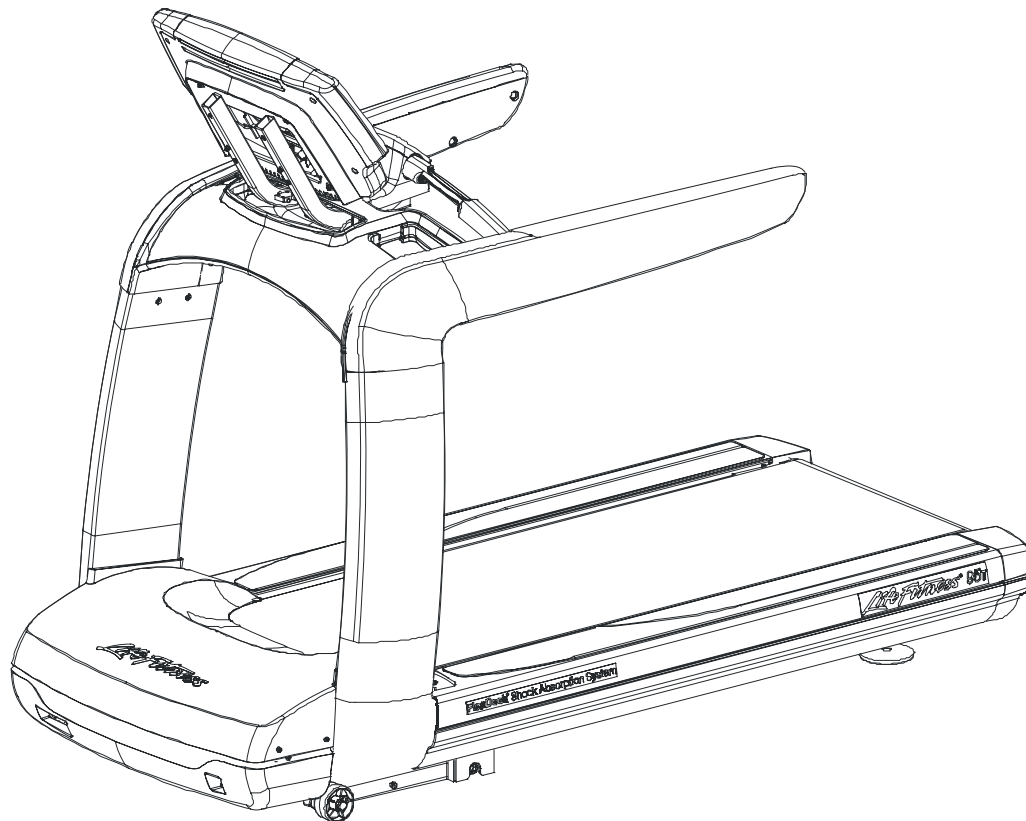

Customer Support Services PARTS MANUAL rev 22 May 2008

Miscellaneous	3
Rear End Caps.....	4
Anti-slip Pad and Extrusions	5
Console Assembly	6
Uprights and Covers	7
Bridge Covers and Activity Zone	8
Handrails and Covers	9
Console Bracket and Covers	10
Ergo Bar Components.....	11
Motor Pan Covers.....	12
Motor Pan Brackets	13
Belt, Deck, and Rollers.....	14
Deck Springs, Stride Sensor, and Roller Guards	15
Lift Motor and Hardware	16
Lift Frame and Wheels	17
DSP Motor Controller and Comm Port Plate Assembly	18
On/Off Switch, Home Switch, and Line Filter	19
Drive Motor Assembly.....	20
Idler Assembly and Drive Belt	21
Leg Leveler Assembly.....	22
Cables.....	23

Description	Part No.
OPERATION MANUAL	M051-00K65-A001
HARDWARE BAG BAG CONSISTS OF: C-SAFE Splitter SCREW - 8-18x12 SCREW - M6x1.00-6G6Gx20 SCREW - M6x1.00-6G6Gx35 SCREW - M12x1.75-6G6Gx30 SCREW - M6x1.00-6G6Gx14 SCREW - 10-16X8 SCREW - M3x.8-6G6Gx10 WASHER - M006.50 WASHER - M012.70	AK65-00025-0000 0017-00021-2740 0017-00101-1769 - 2 PCS. 0017-00101-1902 - 7 PCS. 0017-00101-1954 - 6 PCS. 0017-00101-1984 - 16 PCS. 0017-00101-1953 - 68 PCS. 0017-00101-1776 - 8 PCS. 0017-00101-1995 - 4 PCS. 0017-00104-0488 - 19 PCS. 0017-00104-0489 - 16 PCS.
TOUCH UP PAINT: SPRAY CAN .5 OZ BOTTLE W/APPLICATOR .33 OZ PEN	0017-00008-0204 0017-00008-0205 0017-00008-0206
LINE CORDS: Domestic Low Voltage Domestic High Voltage International High Voltage (Cont.) UK* Australia* China* Line cord Bracket - (INT only) SCREW - M4x.07-6G6Gx10 (INT only)	0017-00003-0980 0017-00003-0781 0017-00003-0696 0017-00003-0890 0017-00003-0996 0017-00003-1014 0K65-01131-0000 0017-00101-1968 - 2 PCS.

This treadmill has both Lifepulse hand sensors and telemetry and is pre-wired for attachable TV.

* The UK, Australia, and Chinese line cords are included in the 95T-INTHX-01 ship kit.

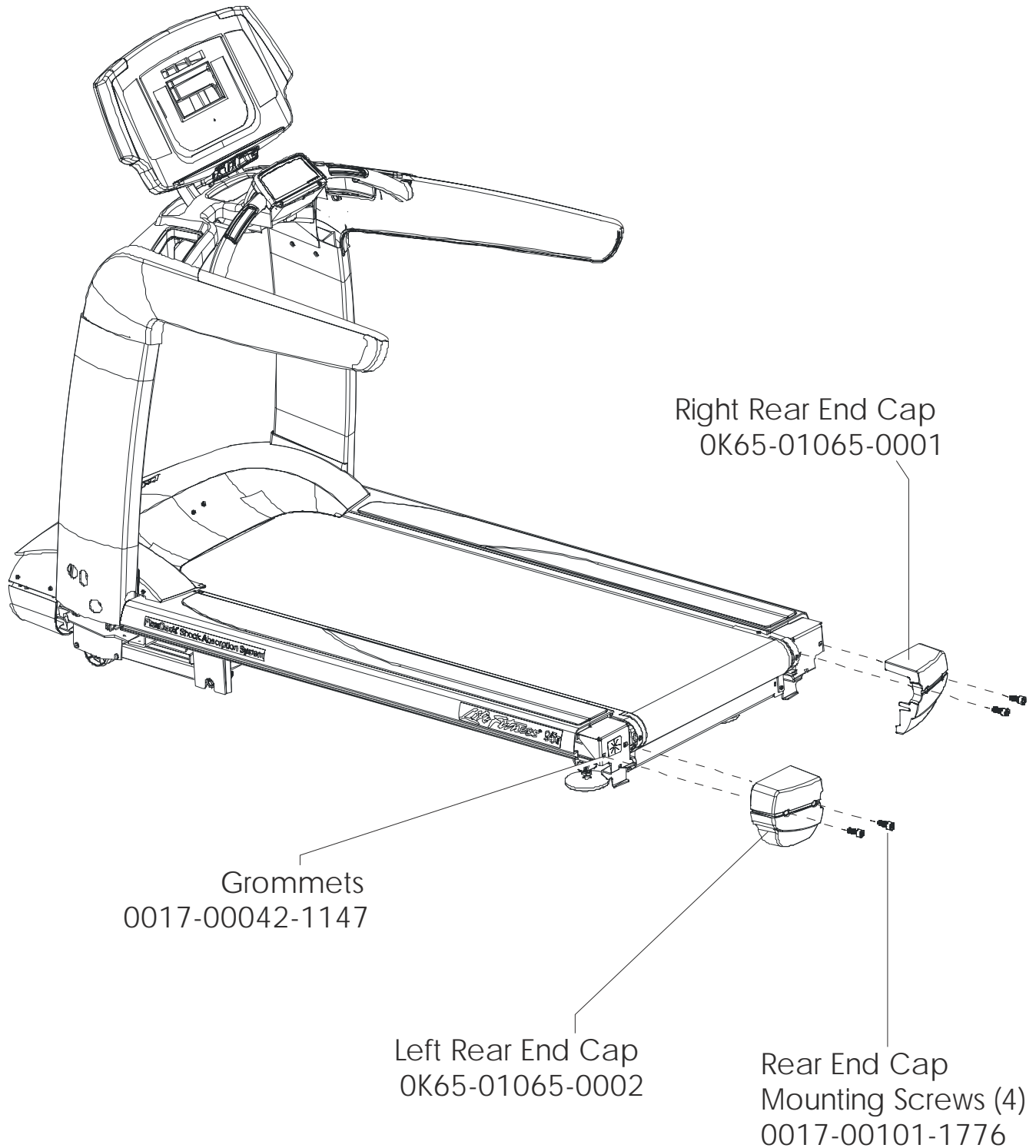

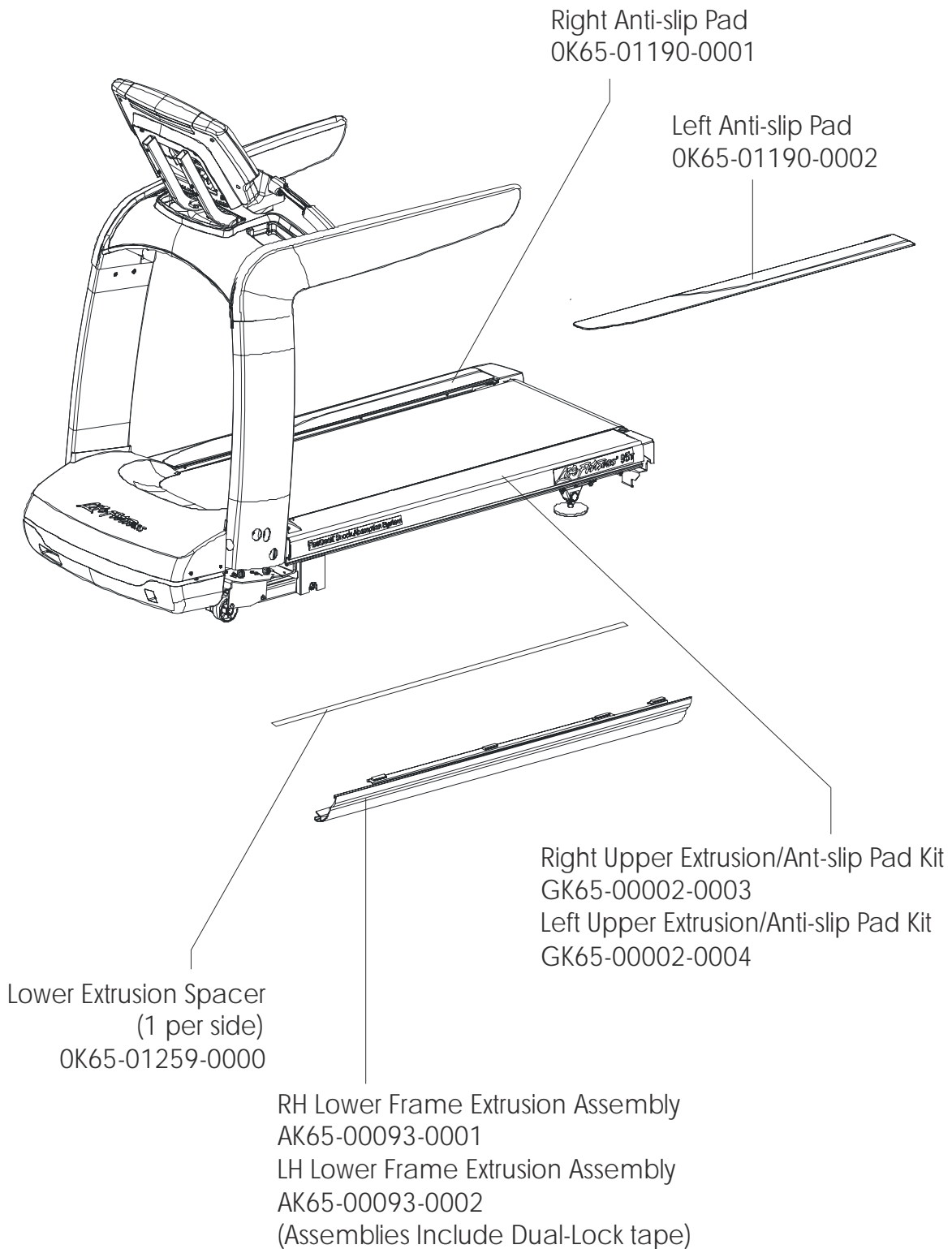

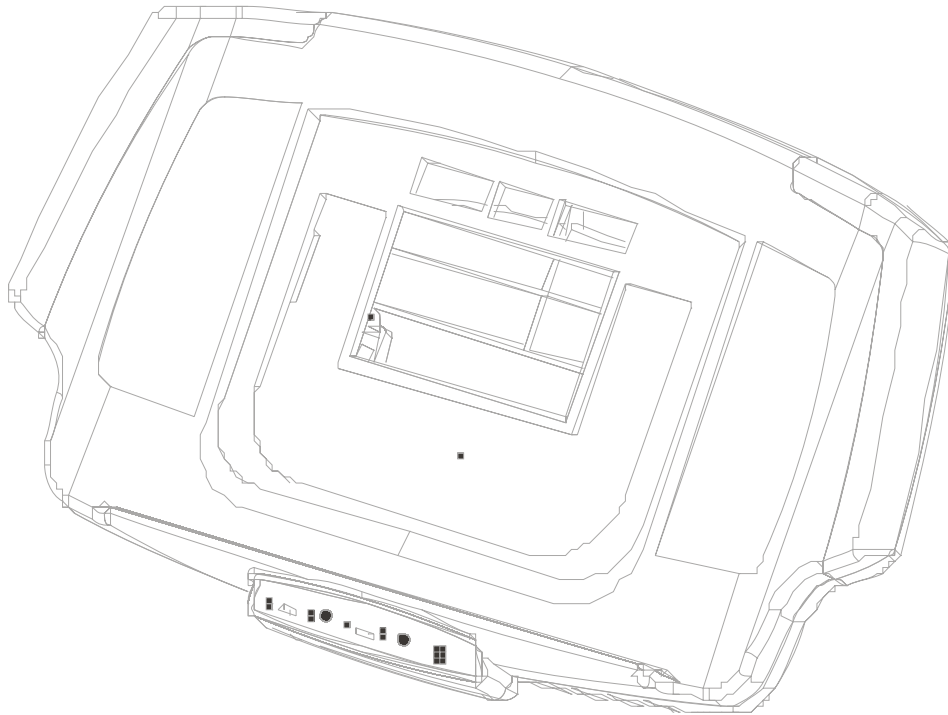

Description	Part No.
LED TREADMILL CONSOLE - ENGLISH	LEDT-DOMXX-01
LED TREADMILL CONSOLE - INTERNATIONAL	LEDT-INTXX-01
7-INCH LCD TREADMILL CONSOLE DOM	07DT-DOMXX-01
7-INCH LCD TREADMILL CONSOLE INT	07DT-INTXX-01
15-INCH LCD TREADMILL CONSOLE DOM NTSC	15DT-DOMXN-01
15-INCH LCD TREADMILL CONSOLE NTSC	15DT-INTXN-01
15-INCH LCD TREADMILL CONSOLE PAL	15DT-INTXP-01

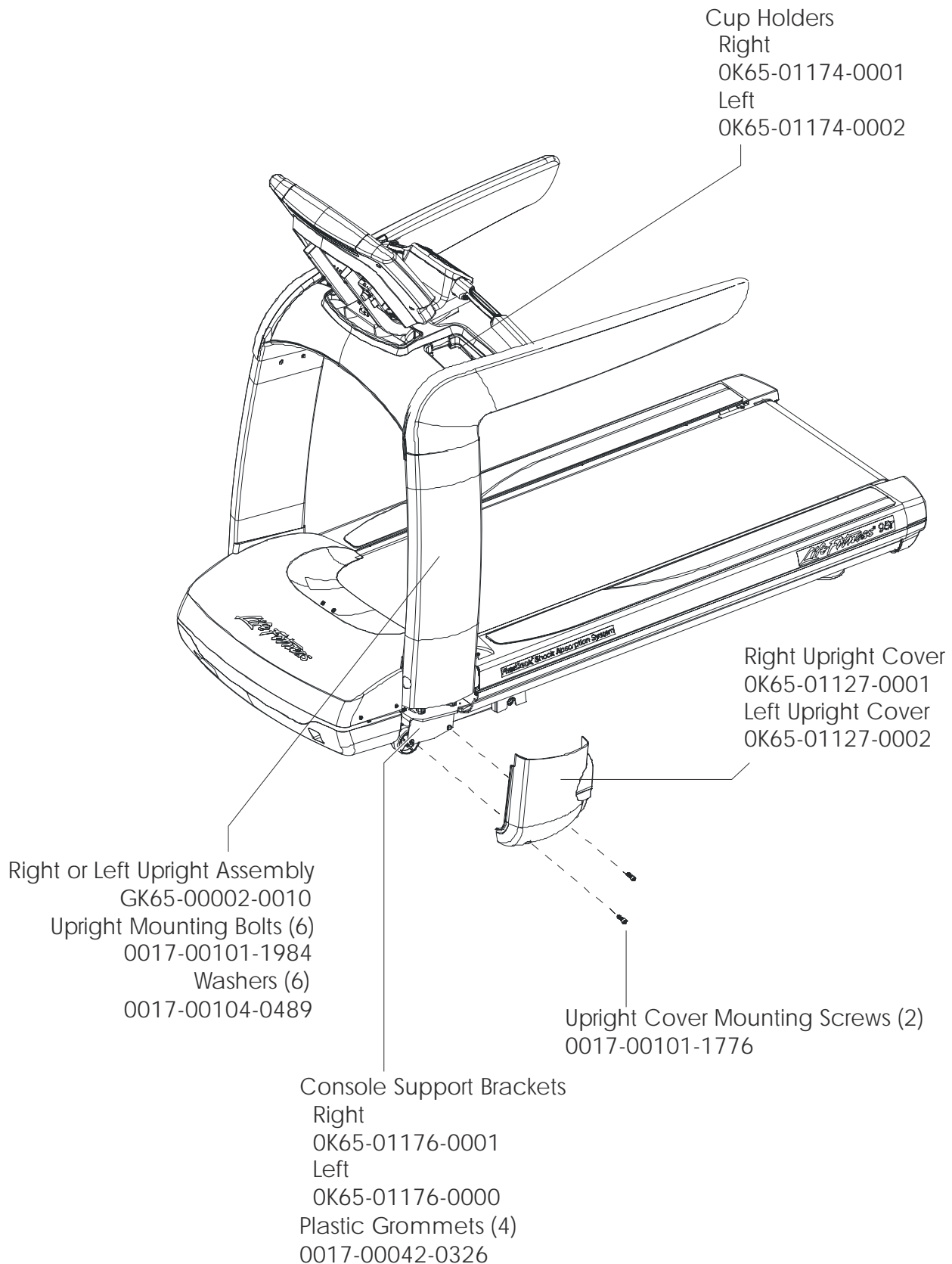

Top Bridge Cover
OK65-01051-0000

Bottom Bridge Cover
OK65-01052-0000

Bezel Access Door
OK65-01053-0000

Bridge Access Door
OK65-01208-0000

Bridge Cover Mounting Screws (10)
0017-00101-1953

Cupholders

Right
OK65-01174-0001

Left
OK65-01174-0002

Activity Zone Assembly
AK65-00015-0000

Mounting Screws (2)
0017-00101-1954

Stop Switch and Tether Assembly
(included in the Activity Zone Assembly)
AK65-00037-0000



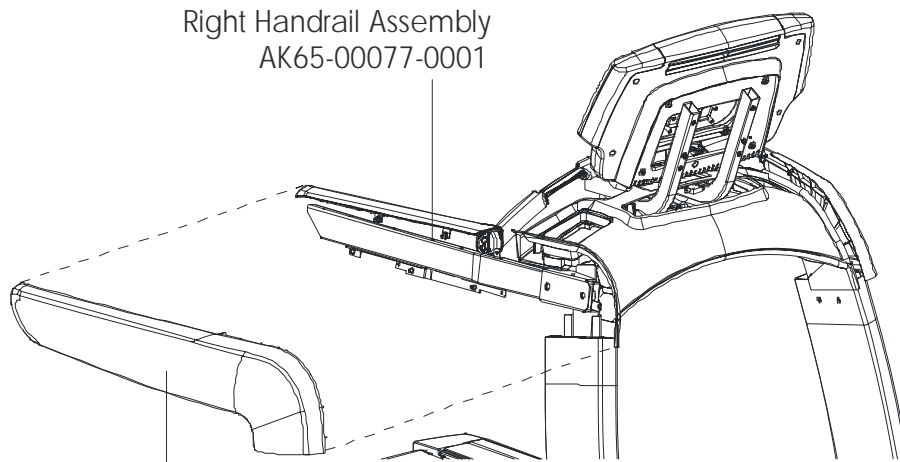

Right Handrail Assembly
AK65-00077-0001

Right Outer Handrail Cover
OK65-01167-0001

Outer Handrail Mounting Screw
(6 per cover)
0017-00101-1953

Left Handrail Assembly
AK65-00077-0002

Left Outer Handrail Cover
OK65-01167-0002

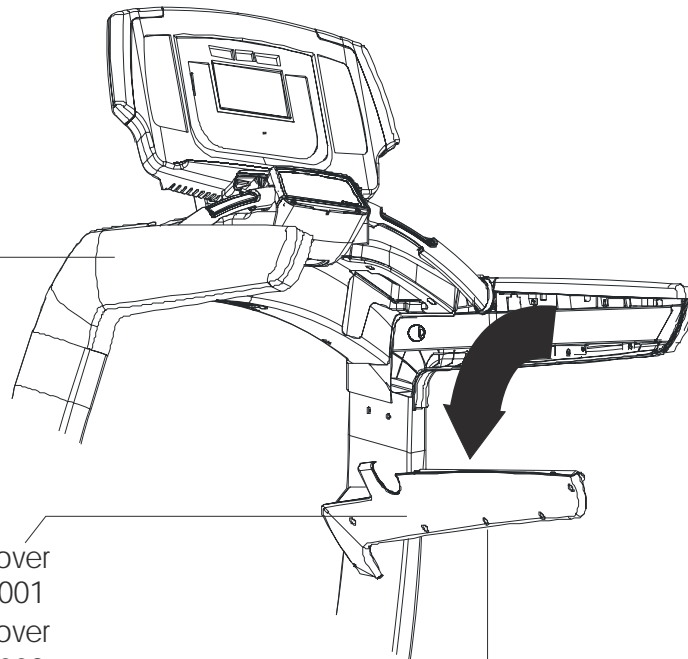

Right Inner Handrail Cover
OK65-01168-0001

Left Inner Handrail Cover
OK65-01168-0002

Inner Handrail Mounting screw
(5 per cover)
0017-00101-1953

Inner Handrail Plug
OK65-01225-0000

Bag of 10 plugs
AK65-00101-0000

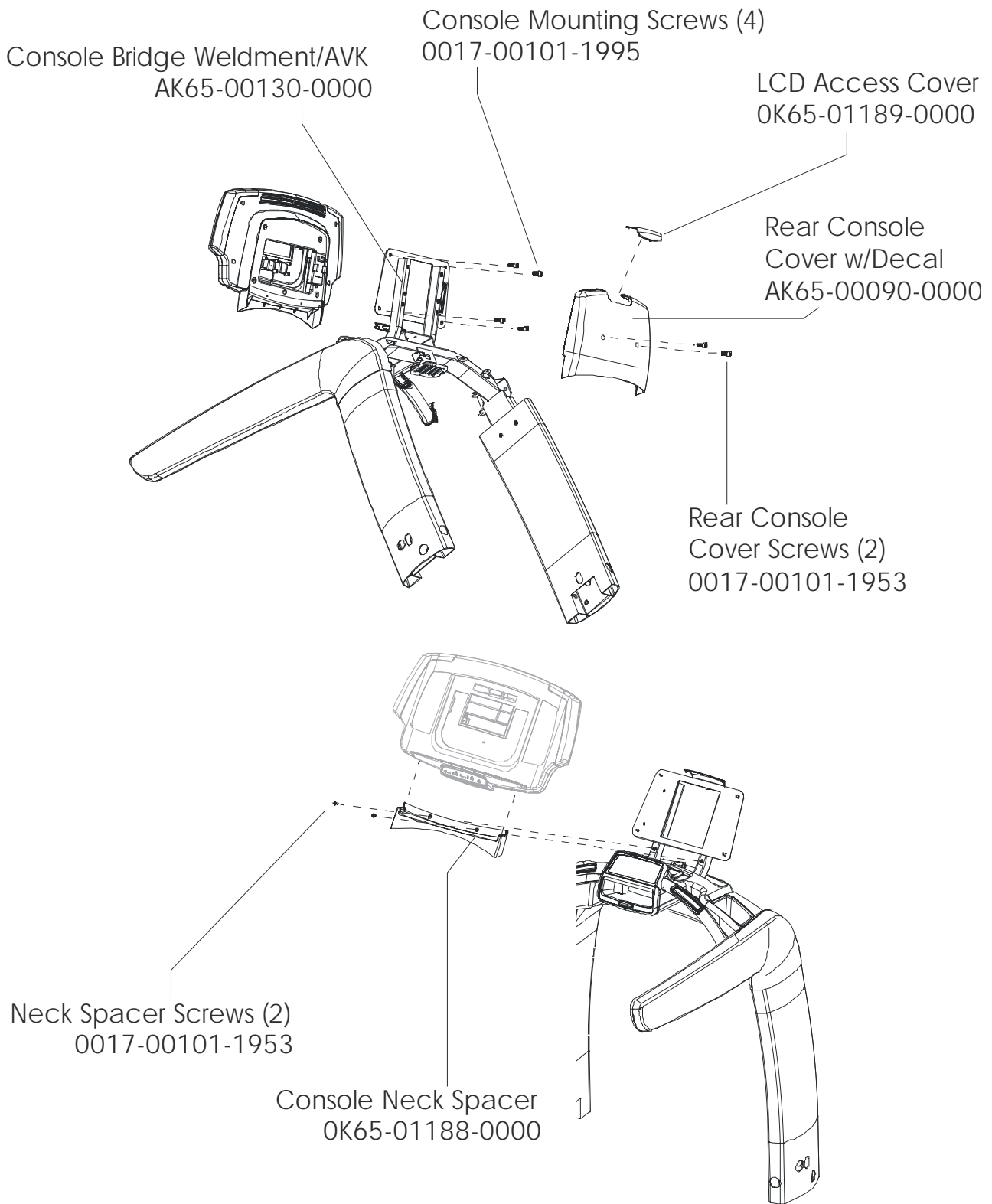

HR Sensor Kit: GK65-00002-0002
(kit includes 4 sensors, sensor gasket, mounting screws)

Bridge Weldment
AK65-00129-0000

Bridge Weldment
Mounting Screws (6)
0017-00101-1984

Inner Ergo Bar Gasket (right)
OK65-01204-0001

Inner Ergo Bar
Gasket (left)
OK65-01204-0002

Ergo Bar Assembly
(includes HR sensors kit
and inner Ergo bar gaskets)
AK65-00014-0000
Mounting Screws (4)
0017-00101-1954
Flat Washers (4)
0017-00104-0488

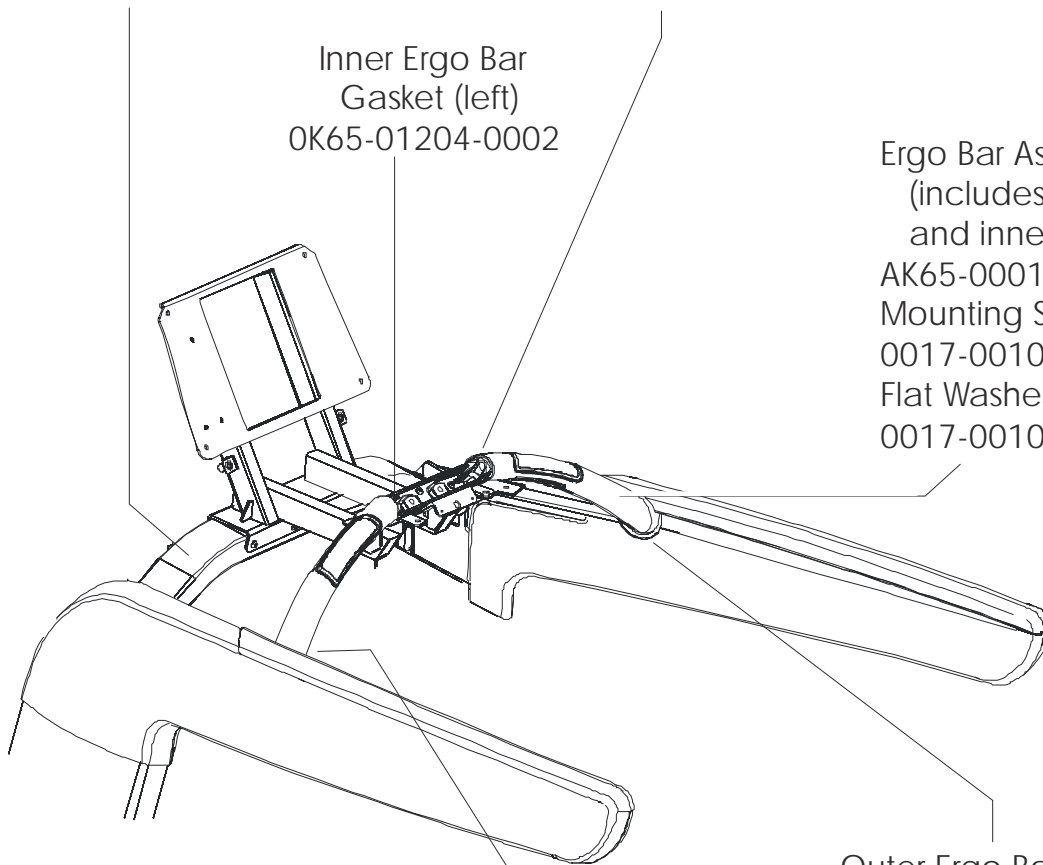

Outer Ergo Bar Gasket (left)
OK65-01203-0002

Outer Ergo Bar Gasket (right)
OK65-01203-0001
Heart Rate Electrodes Gaskets
Front
OK65-01133-0001
Back
OK65--1133-0002

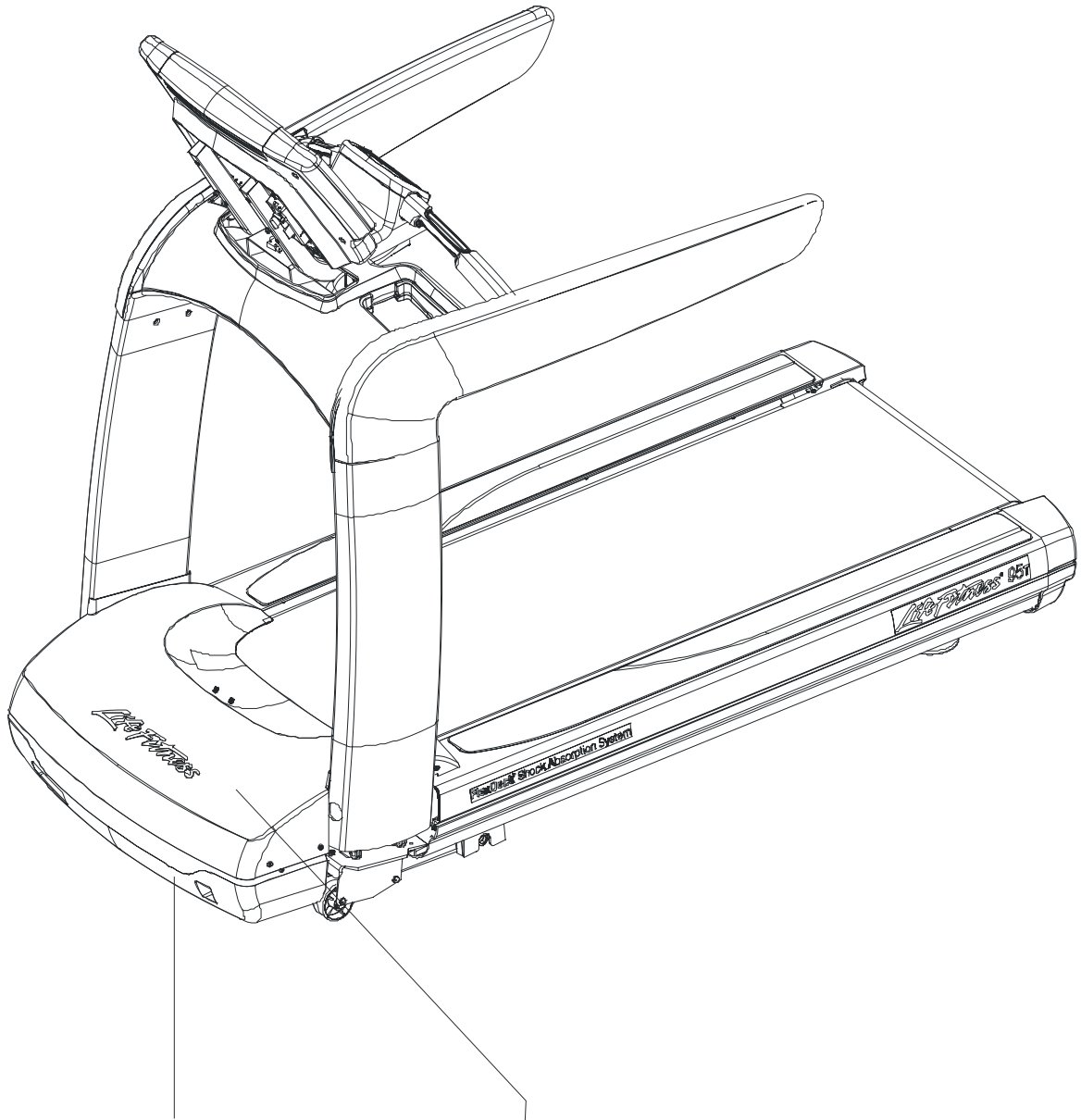

Bottom Motor Cover
OK65-01126-0000
Motor Cover Screws (4)
0017-00101-1776

Top Motor Cover
OK65-01125-0000
Motor Cover Screws (4)
0017-00101-1776

Actuator and Frame
Tie Weldment
AK65-00088-0000
Flat Washers (5)
0017-00104-0334
Mounting Bolts (5)
0017-00101-1983
Lock Washers (5)
0017-00104-0064
Mounting Bolts (2)
0017-00101-1982
Flat Washers (2)
0017-00104-0492

Bar Tie
OK65-01187-0000
Bar Tie Mounting Hardware
Bolts (4)
0017-00101-1959
Nuts (4)
0017-00103-0333
Washers (4)
0017-00104-0330
Washers (4)
0017-00104-0263

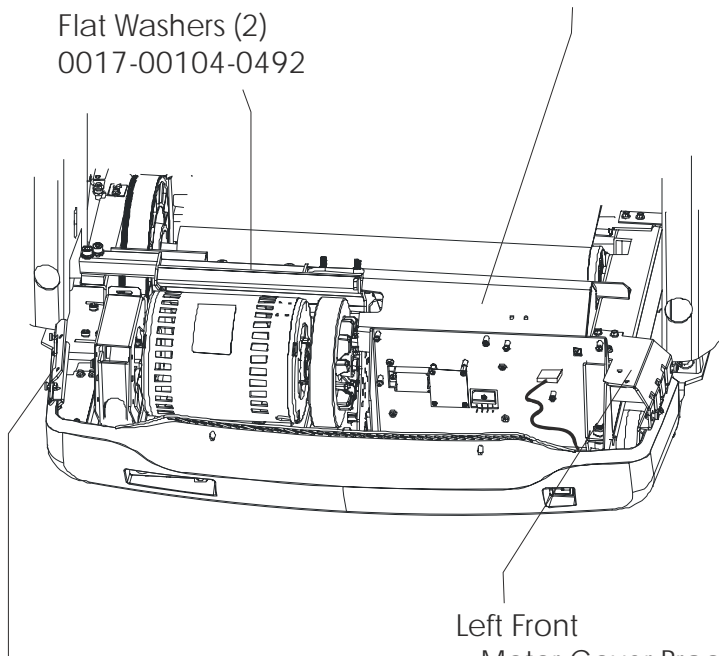

Right Front
Motor Cover Bracket
OK65-01134-0001
Mounting Screws (3)
0017-00101-1961
Nylon Screw Grommet
0017-00042-1147

Left Front
Motor Cover Bracket
OK65-01134-0002
Mounting Screws (4)
0017-00101-1961

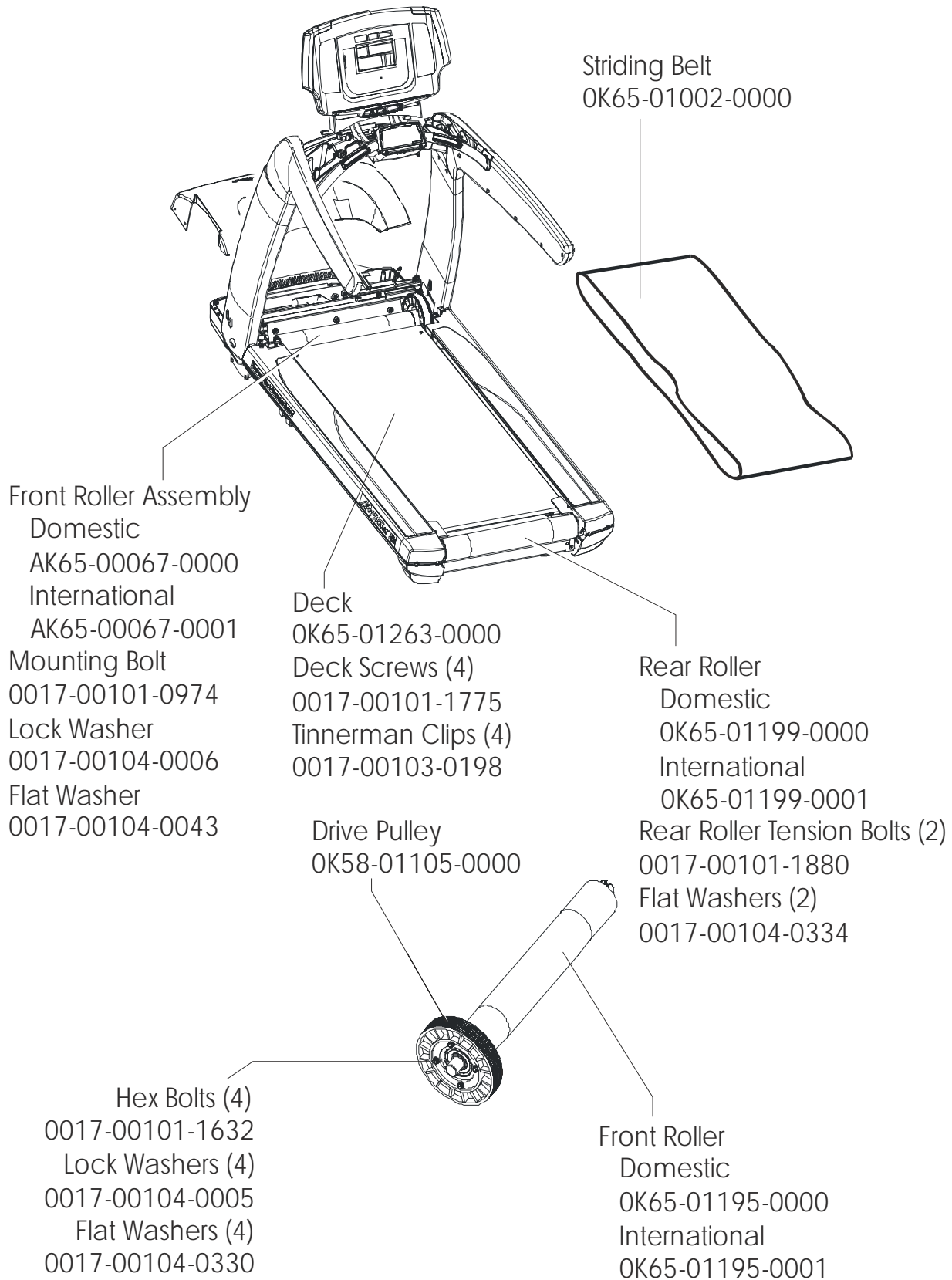

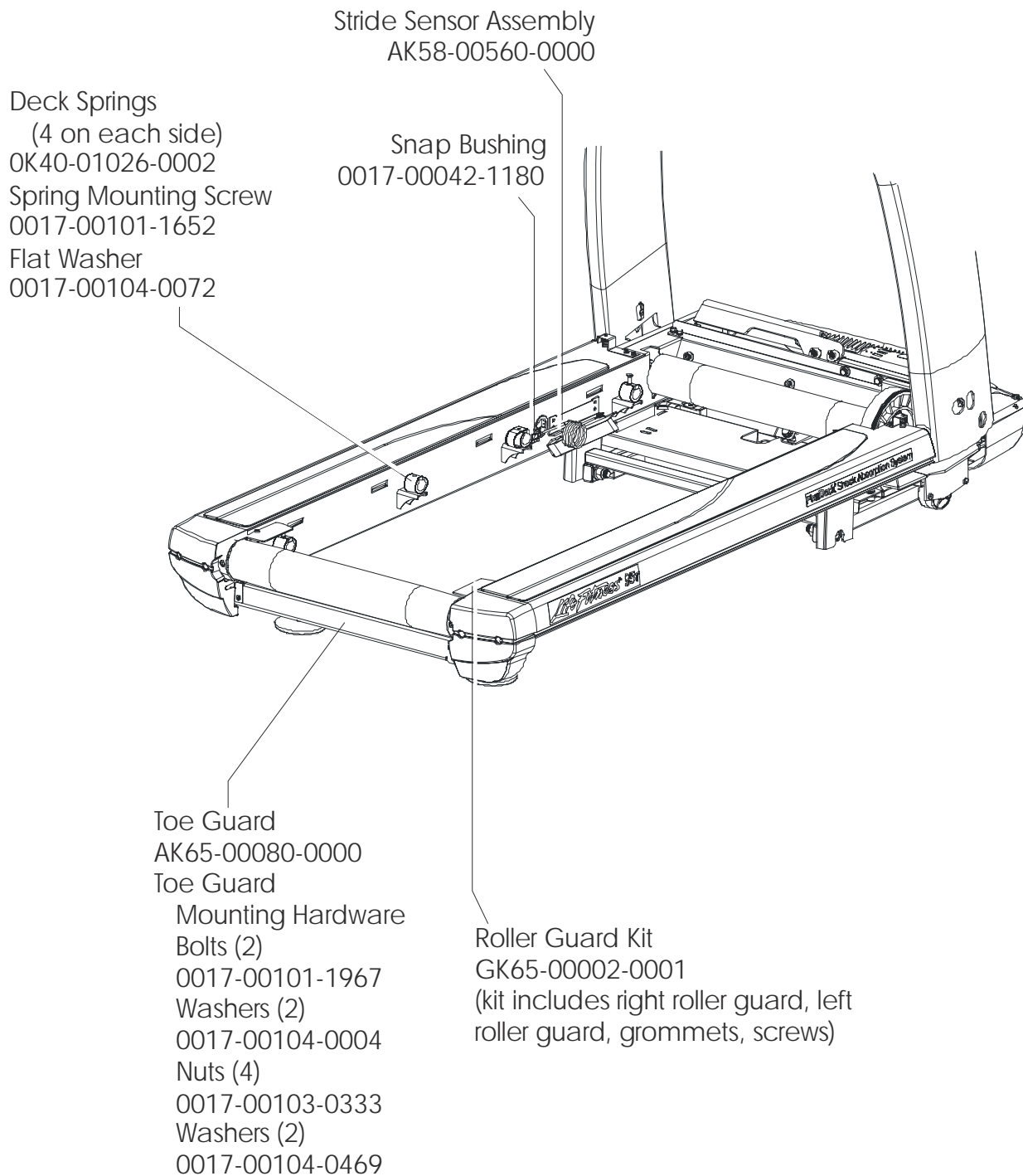

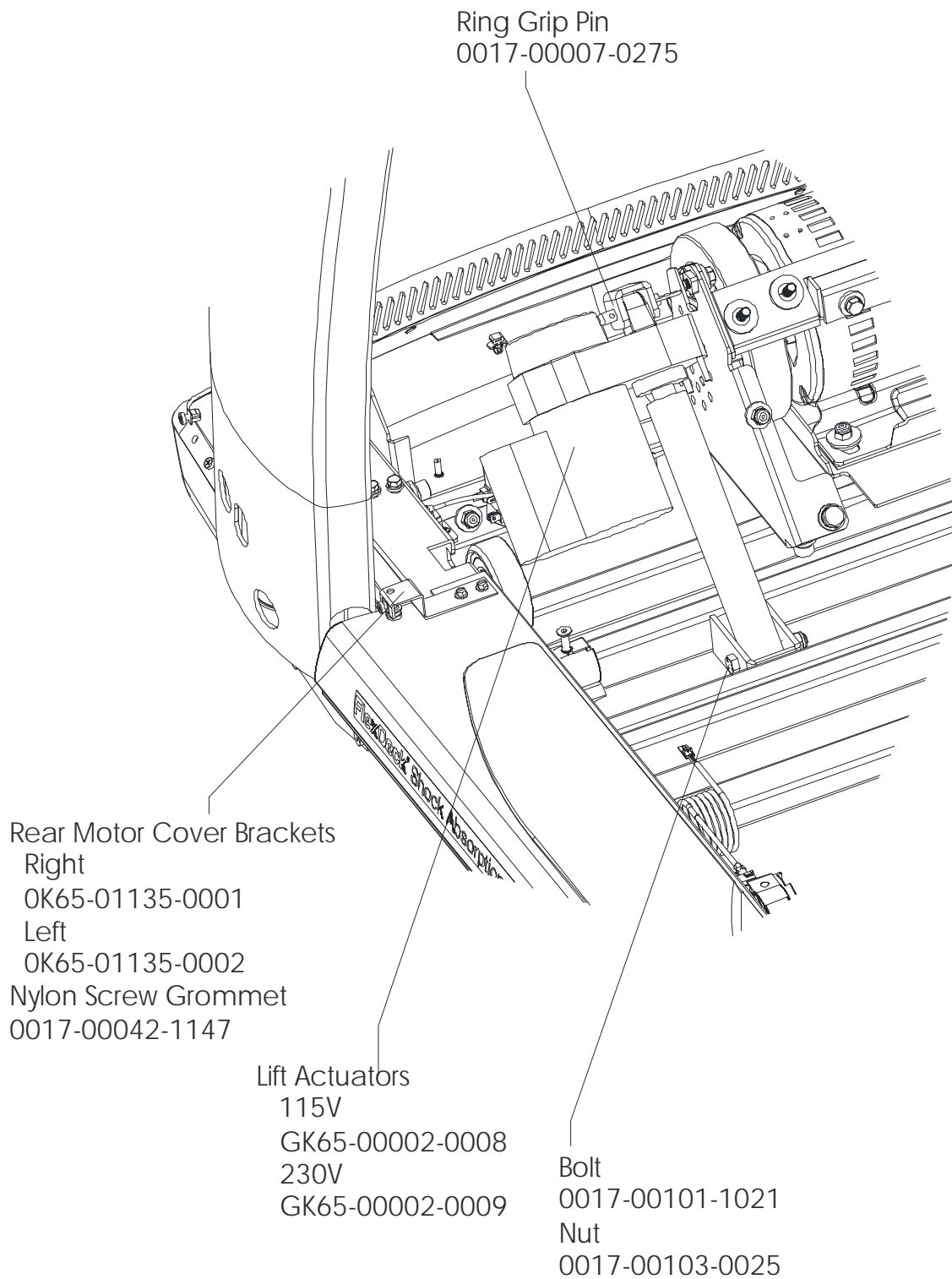

Lift Frame Assembly
AK65-00035-0000
(includes lift frame, wheels,
snap rings, end caps)

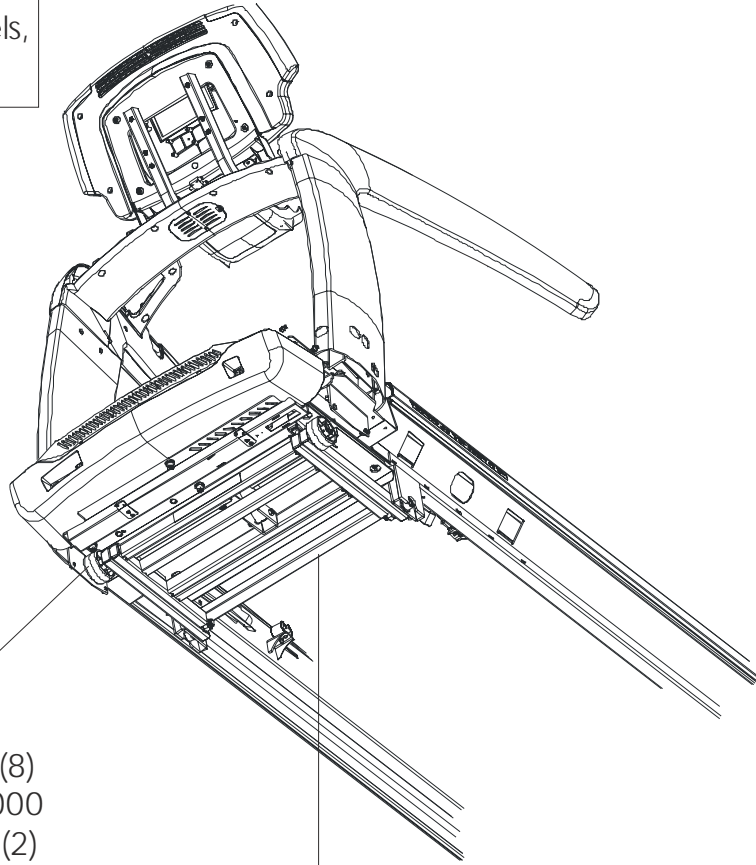

Tube End Caps (8)
OK60-01092-0000
Lift Wheels (2)
OK65-01245-0000
Snap-Rings (2)
0017-00100-0249

Painted Lift
Frame Weldment
AK65-00089-0001
Lift Frame Mounting Bolts (2)
0017-00101-1964
Lift frame Mounting Nuts (2)
0017-00103-0349
Washers (2)
0017-00104-0259
Sleeve Bushings (2)
OK65-01242-0000

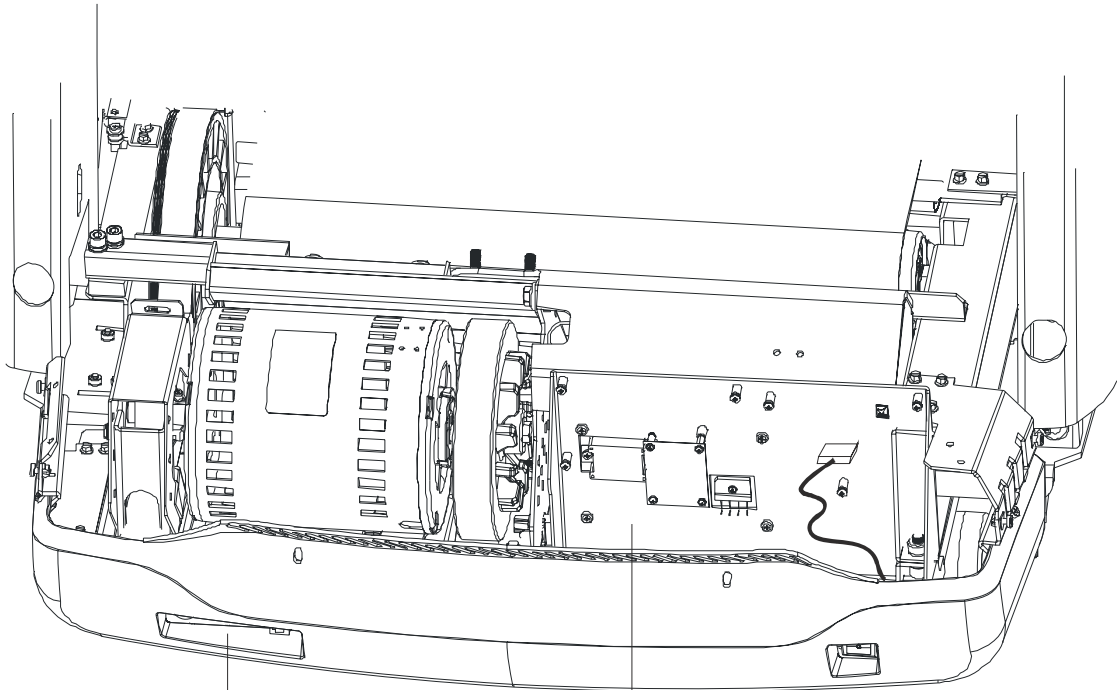

Comm Port Plate Assembly
AK65-00082-0000

includes one of each:

F-type Right Angle Adaptor

0017-00021-2810

F-type Panel Connector

0017-00021-2846

Phone Jack Panel Receptacle

0017-00021-2847

DSP Motor Controller with Cable

GK65-00002-0005 100-120V

GK65-00002-0006 200-240V

Hex Nut (3)

0017-00103-0350

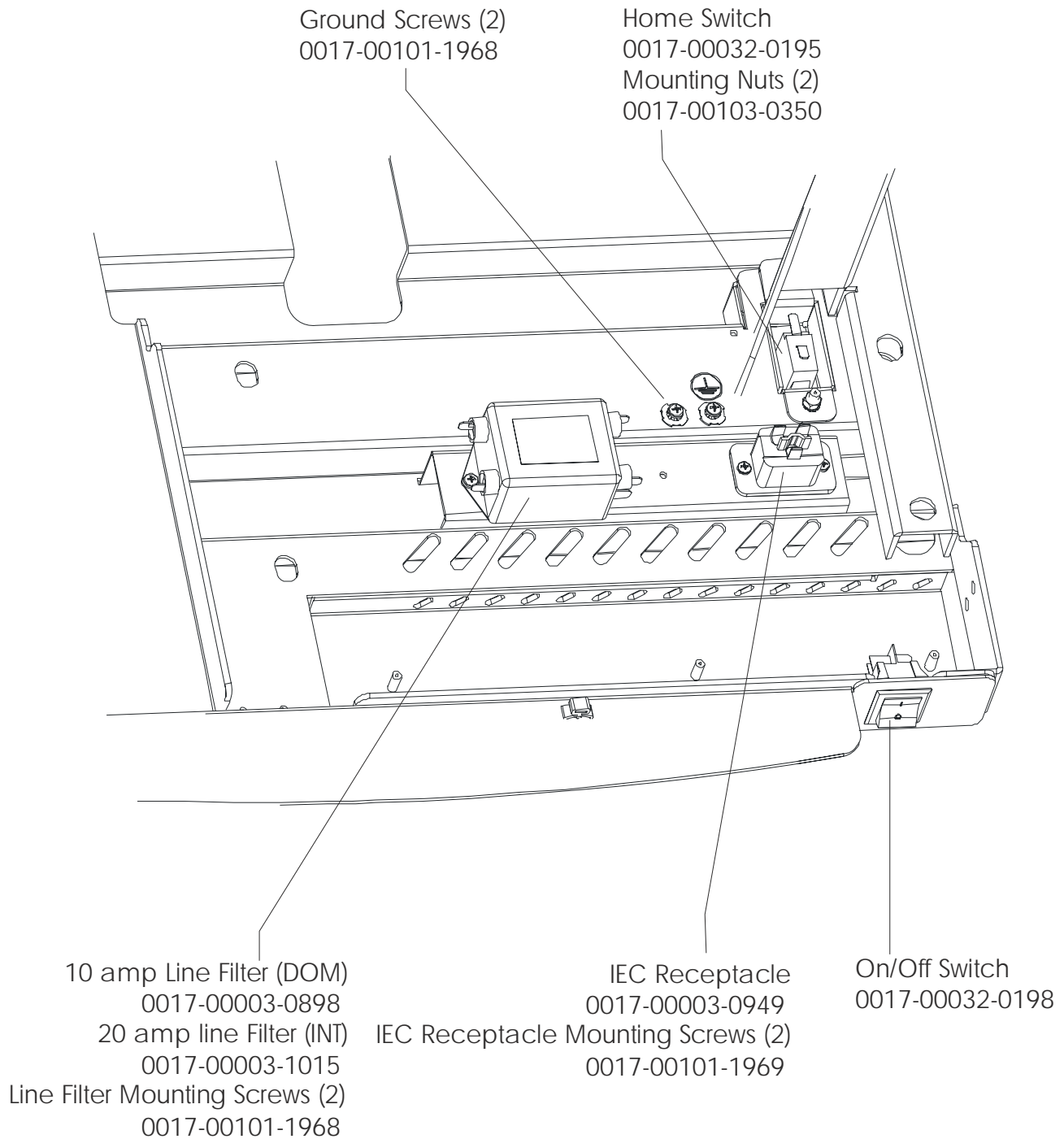

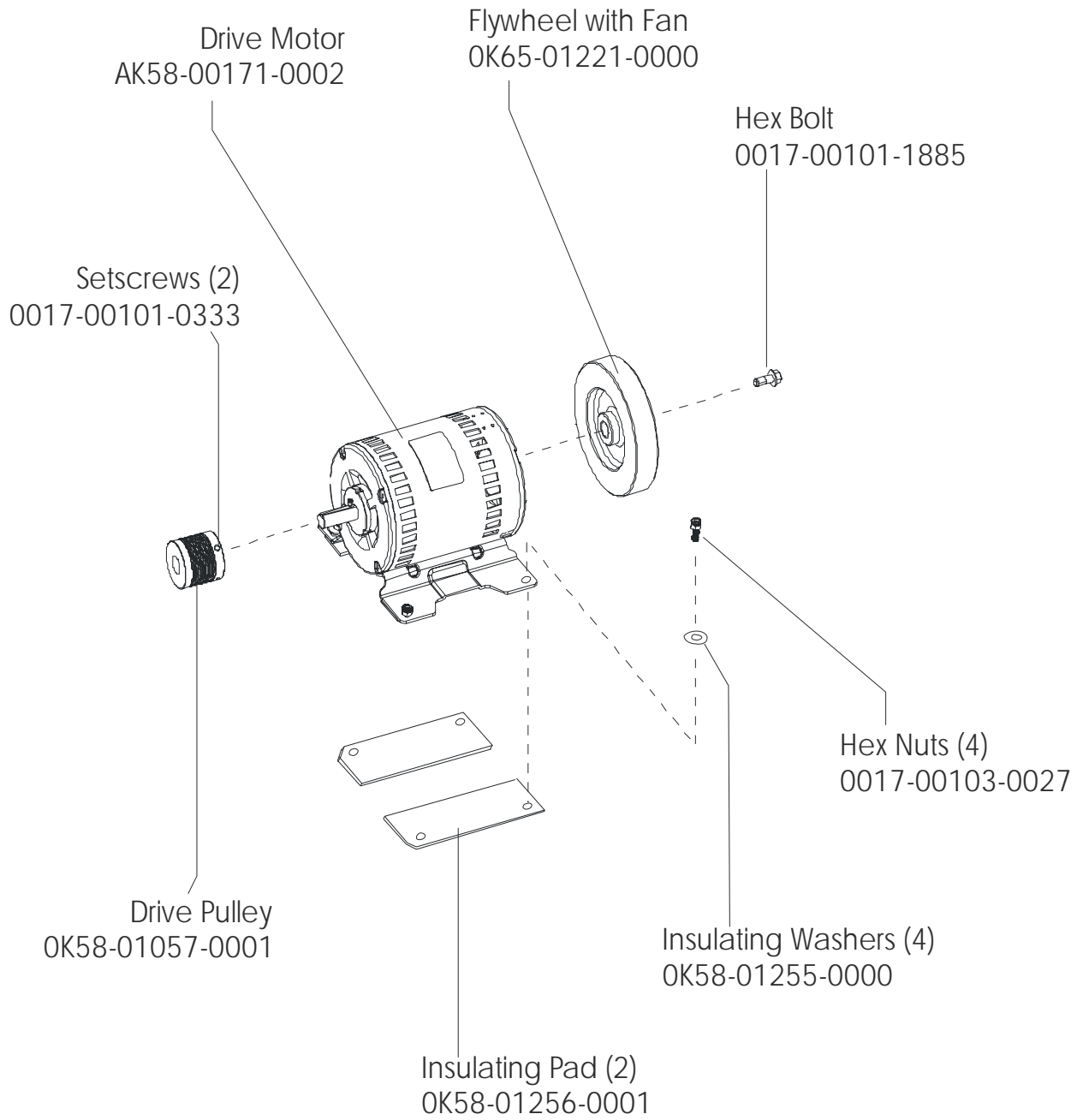

Idler Assembly
AK65-00029-0000
(includes idler bracket plastic
idler, threaded shaft, nut)

Poly-V Drive Belt
OK58-01114-0000

Idler Bracket
OK65-01113-0000
Plastic Idler
OK26-01731-0000
Threaded Shaft
OK58-01084-0002
Nut
0017-00103-0324
Locking Pin
0017-00007-0248
Mounting Nuts (4)
0017-00103-0333

Extension Spring
OK58-01085-0000
Spring Damper
OK26-02055-0000

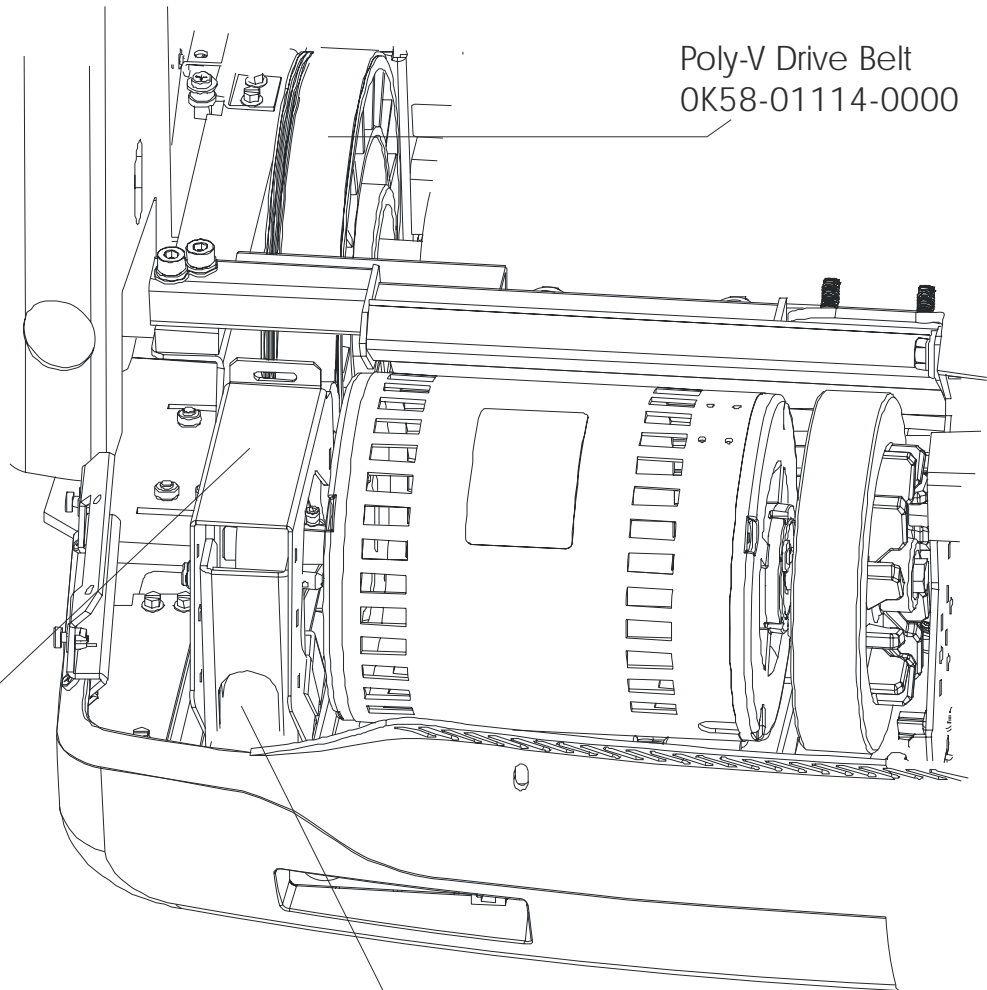

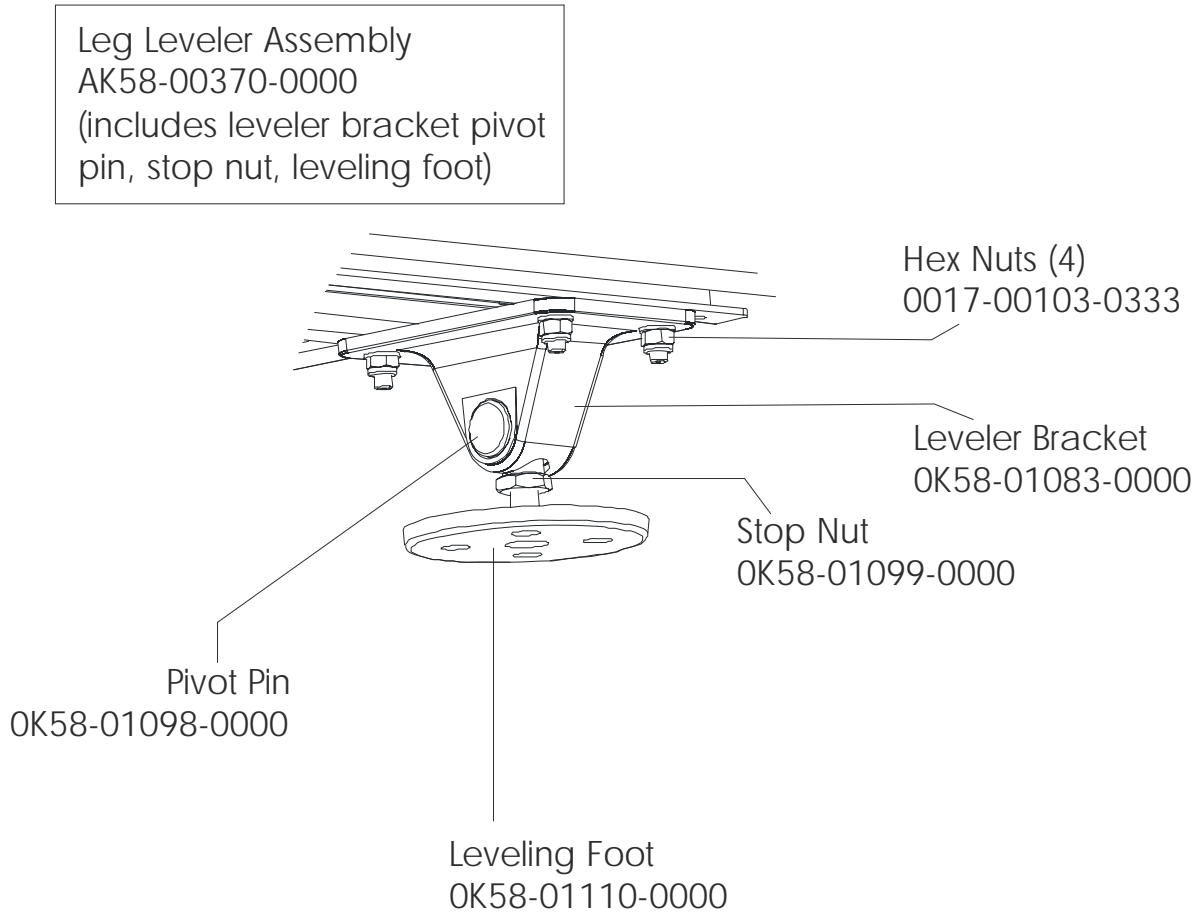

Description	Quantity	Part No.
Green and yellow ground wire with spade lug on one end and ring terminal on the other; one goes from the IEC connector to the frame, the other from the line filter to the frame	2	AK26-00348-0000
External power cable with ferrite	1	AK32-00160-0000
75-inch RG6 coax cable	1	AK65-00062-0000
Main power cable from DSP to console	1	AK58-00034-0001
Mov filter cable with a two-pin connector on one end and a terminal on the other end of one green wire; it also has two spade lugs at the end of a varistor spliced to the other green wire	1	AK58-00224-0001
Hi-pot jumper cable has a two-pin connector with a green wire looped between the pins.	1	AK58-00263-0000
Cable from MIB in console to Activity Zone	1	AK65-00043-0001
Heart rate Ergo bar cable	1	AK65-00047-0000
20-inch C-SAFE cable; from splitter to console	1	AK65-00051-0000
65-inch C-SAFE upright cable; runs from the base to the splitter in the bridge assembly	1	AK65-00051-0001
Cable from on/off switch to motor controller (domestic)	1	AK65-00073-0000
Cable from on/off switch to motor controller (international)	1	AK65-00073-0001
Cable assembly; power DSP, high voltage (international)	1	AK65-00073-0002
Home switch cable from home switch to motor controller	1	AK65-00074-0000
AC power cable with an IEC connector on one end and a ring terminal on the green/yellow wire; spade lugs on the brown and blue wires	1	AK65-00081-0000

Description	Quantity	Part No.
Black and white wires with spade lug on each end; from line filter to IEC connector	1	AK65-00094-0000
Line filter to switch cable with a black and white wire that has spade lugs on one end and flag-type spade lugs on the other	1	AK65-00095-0000
Harness Assembly 120/60 20A components: AK26-00348-0000 Outlet/Gnd Jumper Cable Assembly AK58-00224-0001 MOV Filter Cable Assembly AK58-00263-0000 Hi Pot Jumper cable Assembly AK65-00081-0000 AC Power cable Assembly AK65-00094-0000 IEC to filter cable Assembly AK65-00095-0000 Filter to switch cable Assembly 0017-00003-1015 Line filter 20A	1	AK65-00011-0001
Harness Assembly 230/50 10A components: AK26-00348-0000 Outlet/Gnd Jumper Cable Assembly AK58-00224-0001 MOV Filter Cable Assembly AK58-00263-0000 Hi Pot Jumper cable Assembly AK65-00081-0000 AC Power cable Assembly AK65-00094-0000 IEC to filter cable Assembly AK65-00095-0000 Filter to switch cable Assembly 0017-00003-0898 Line filter 10A	1	AK65-00011-0002
Harness Assembly 220/60 20A components: AK26-00348-0000 Outlet/Gnd Jumper Cable Assembly AK58-00224-0001 MOV Filter Cable Assembly AK58-00263-0000 Hi Pot Jumper cable Assembly AK65-00081-0000 AC Power cable Assembly AK65-00094-0000 IEC to filter cable Assembly AK65-00095-0000 Filter to switch cable Assembly 0017-00003-1015 Line filter 20A	1	AK65-00011-0003

Free Manuals Download Website

<http://myh66.com>

<http://usermanuals.us>

<http://www.somanuals.com>

<http://www.4manuals.cc>

<http://www.manual-lib.com>

<http://www.404manual.com>

<http://www.luxmanual.com>

<http://aubethermostatmanual.com>

Golf course search by state

<http://golfingnear.com>

Email search by domain

<http://emailbydomain.com>

Auto manuals search

<http://auto.somanuals.com>

TV manuals search

<http://tv.somanuals.com>