

**READ AND UNDERSTAND THESE INSTRUCTIONS  
BEFORE INSTALLING LUMINAIRE.**

This luminaire is intended for installation in accordance with the National Electrical Code and local regulations. To assure full compliance with local codes and regulations, check with your local electrical inspector before installation. To prevent electric shock, turn off electricity at main power supply before proceeding.  
**Retain these instructions for maintenance reference.**

INSTRUCTION SHEET NO.

**IS:1101FEM**

D1007

Page 1 of 4

**INSTALLATION PROCEDURE FOR:**

**Lytcaster® 1001FEM, 1101FEM and 1101FEL Series Frame-In Kits with Emergency Backup**

**CAUTION: (RISK OF FIRE) THIS IS A NON-IC RATED FRAME-IN KIT.**

**DO NOT INSTALL INSULATION ABOVE OR WITHIN 3 INCHES (76mm) OF ANY PART OF LUMINAIRE.**

**CAUTION: USE ONLY WITH REFLECTOR TRIMS PROVIDED BY LIGHTOLIER. USE OF OTHER MANUFACTURER'S TRIMS MAY VOID THE UNDERWRITERS LABORATORIES LISTING AND COULD CONSTITUTE A FIRE HAZARD.**

**CAUTION: BEFORE INSTALLING FRAME-IN KIT AND REFLECTOR TRIM, READ ALL MARKINGS ON FRAME-IN KIT AND REFLECTOR TO DETERMINE LAMP WATTAGE AND TYPE APPLICABLE FOR YOUR INSTALLATION.**

**INSTALLATION INSTRUCTIONS FOR GRID CEILING APPLICATIONS**

**1 PREPARATION:** Cut appropriately sized hole in Ceiling Tile (by others) at the position desired and place Ceiling Tile in Grid (by others) (Figure A). Loosen Wing Nuts on Frame Clamps enough to allow free movement of Mounting Bars (Figure B).

\* Lightolier offers a hole cutter (HC-356) that can be purchased separately to assist with quick, clean trim installations. In this case, follow the hole cutting directions supplied with HC-356.

**2 POSITION LUMINAIRE FRAME:** Place Luminaire Frame on top of Ceiling Tile and center the frame aperture on the Ceiling Tile hole cut in Step 1 so that the aperture wall extends into the Ceiling Tile. Orient the Luminaire Frame to align with the grid (Figure C). Grasp the T-Bar Clips on each end, one in each hand, lift the clips to the top of the adjustment slots in the End bracket, extend the End brackets to contact the Ceiling Grid, and drop each T-Bar Clip over the Grid (Figure D).

**NOTE:** When the Luminaire Frame is to be used with Wall Wash Trims make sure to orient the Luminaire Frame side indicated by a label on the frame towards the wall to be illuminated.

**3 CLAMP TO GRID and LOCK LUMINAIRE FRAME:** Making certain that the Luminaire Frame is still centered on the Ceiling Tile, tighten the T-Bar Clip Wing Nuts to attach the frame to the Ceiling Grid (Figure E). Retighten the Wing Nuts on the Frame Lock Clamps after the frame is positioned satisfactorily and is locked to the Ceiling Grid.

APERTURE HOLE SIZE	
1001FEM SERIES	5-1/4" (134mm) DIA
1101FEM SERIES	6-15/16" (176mm) DIA
1101FEL SERIES	6-15/16" (176mm) DIA

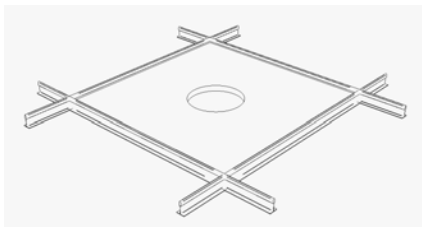

Figure A

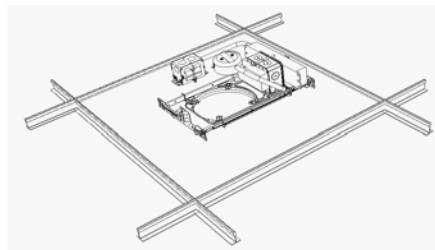

Figure C

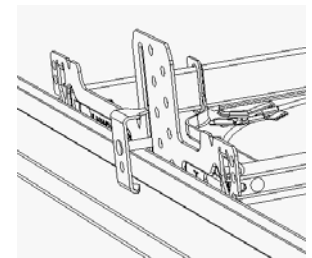

Figure E

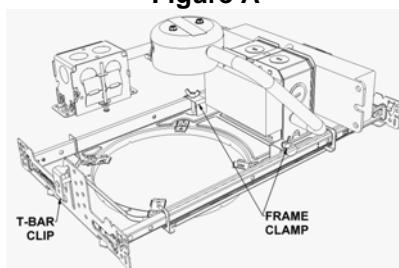

Figure B

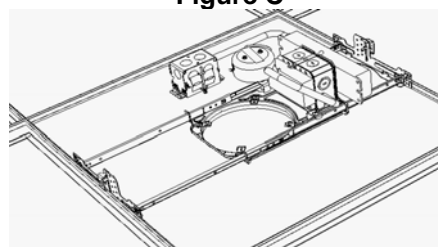

Figure D

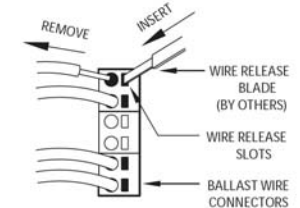

Figure F

\* **BALLAST REPLACEMENT:** Ballast replacement must be performed by a "qualified electrician". **TURN OFF POWER.** Remove reflector trim from luminaire. Remove j-box cover nearest the ceiling opening to which the ballast is mounted by lifting the spring. Remove ballast assembly through the ceiling hole. Disconnect all input wiring to the ballast. Release all wires from ballast wire connectors by inserting small blade tool, with insulated handle, into wire release slots (Figure F). Remove ballast from j-box door and replace with new ballast. Rewire and reassemble.

\* **REFLECTOR TRIM INSTALLATION:** See separate Trim Instruction Sheet for installation procedure.

**LIGHTOLIER®**

**LIGHTOLIER** A **GENIE GROUP** COMPANY  
631 Airport Road, Fall River, MA 02720

**INSTALLATION PROCEDURE FOR:  
1001FEM, 1101FEM and 1101FEL Series Frame-In Kits  
with Emergency Backup**

INSTRUCTION SHEET NO.

**IS:1101FEM**

**IMPORTANT SAFEGUARDS – READ AND FOLLOW ALL SAFETY INSTRUCTIONS**

D1007

Page 2 of 4

**INSTALLATION INSTRUCTIONS FOR WOOD FRAME CEILING APPLICATIONS**

- 1 PREPARATION:** Remove Wing Nuts on T-Bar Clips and remove clips from Luminaire Frame. Loosen Wing Nuts on Frame Clamps enough to allow free movement of Mounting Bars (Figure A). The Mounting Bars may be readily adjusted to fit openings between 13" (330mm) minimum and 24" (610mm) maximum.
- 2 POSITION AND INSTALL LUMINAIRE FRAME:** Position Luminaire Frame between joists with the End bracket at one end placed against, and flush to the bottom of, the joist (Figure B). When positioned, hammer the integral nailing tabs at both ends of the End bracket into the joist (Figure C). Extend the End bracket at the opposite end of the Luminaire Frame until it contacts the opposite joist. Align and attach. The frame can be fully secured by driving a nail or screw through any of the holes provided at each end of the End bracket. Slide the Luminaire Frame along the Mounting Bars until the aperture is in the desired position and lock the Frame in place by tightening the Wing Nuts on the Frame Clamps.

**NOTE:** When the Luminaire Frame is to be used with Wall Wash Trims make sure to orient the Luminaire Frame side indicated by a label on the frame towards the wall to be illuminated.

- \* **INSTALLATION OPTION FOR REGIONS USING STRAPPING:** The Luminaire Frame may be installed directly to strapping as above by screwing the End Bracket to the strapping using the hole provided. The Nailing Tab is not used in this case.

**Optionally,** the Luminaire Frame may be attached to the joists between strapping, and positioned 5/8" lower to account for the strapping thickness, by bending the provided End bracket tabs 90° as shown (Figure D) with a pair of pliers. These bent tabs may now be used to position the Luminaire Frame vertically with reference to the joists so that the frame is flush to the strapping. Attach the Luminaire Frame to the joists as described above (Figure E).

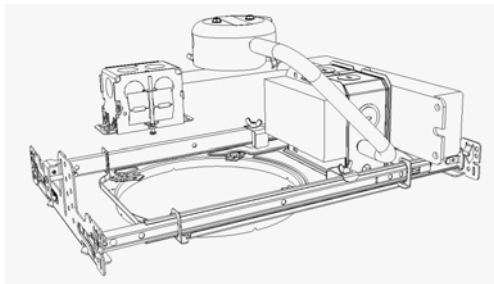

Figure A

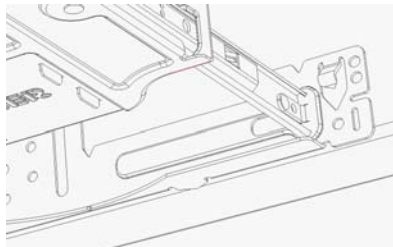

Figure C

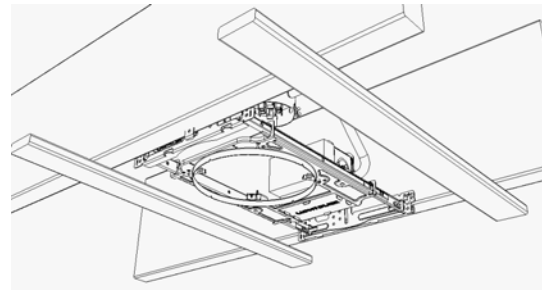

Figure E

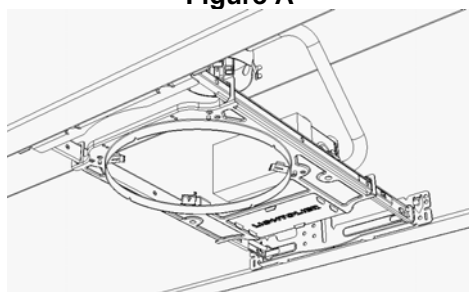

Figure B

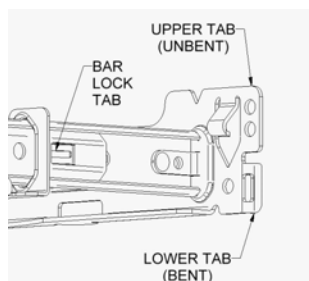

Figure D

**WIRING:**

1. Make sure A.C. power is off at the main power supply.
2. A.C. Ballast and Emergency Ballast must be fed from the same branch circuit.
3. In switched luminaire installations the Emergency Ballast must be connected ahead of any local switching.
4. Check markings on fixture before making connections in junction box. See additional battery pack instruction sheet for wiring diagrams.
5. Be sure all electrical connections are made before connecting UNIT CONNECTOR located in JUNCTION BOX.

**LIGHTOLIER®**

**LIGHTOLIER A GENITE COMPANY**  
631 Airport Road, Fall River, MA 02720

**INSTALLATION PROCEDURE FOR:  
1001FEM, 1101FEM and 1101FEL Series Frame-In Kits  
with Emergency Backup**

INSTRUCTION SHEET NO.

**IS:1101FEM**

**IMPORTANT SAFEGUARDS – READ AND FOLLOW ALL SAFETY**

D1007

Page 3 of 4

**INSTALLATION INSTRUCTIONS FOR STEEL CONSTRUCTION APPLICATIONS**

- 1 PREPARATION:** Remove Wing Nuts on T-Bar Clips and reverse clips to inside of Luminaire Frame. Loosen Wing Nuts on Frame Clamps enough to allow free movement of Mounting Bars. Using standard ½” EMT tubing, cut pieces to required length such that it spans across Hat Channel. Position EMT across Frame Mounting Bars and loosely secure to End Brackets with T-Bar Clips. (Figures A, B, & C)

**NOTE:** The Mounting Bars may be readily adjusted to fit desired openings between 13” (330mm) minimum and 24” (610mm) maximum.

- 2 POSITION AND INSTALL LUMINAIRE FRAME:** Position Luminaire Frame at approximate location with EMT resting on Hat Channel. Secure EMT to Hat Channel. Adjust frame to final location by sliding along EMT & Mounting Bars. Lock the Frame in place by tightening the Wing Nuts on the Frame Clamps and T-Bar Clips.

**NOTE:** When the Luminaire Frame is to be used with Wall Wash Trims make sure to orient the Luminaire Frame side indicated by a label on the frame towards the wall to be illuminated.

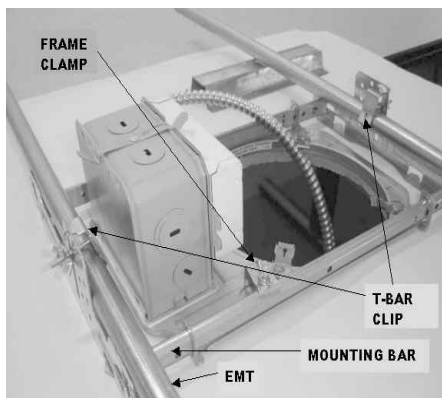

Figure A

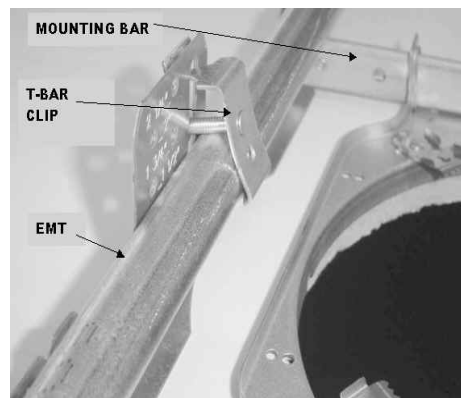

Figure B

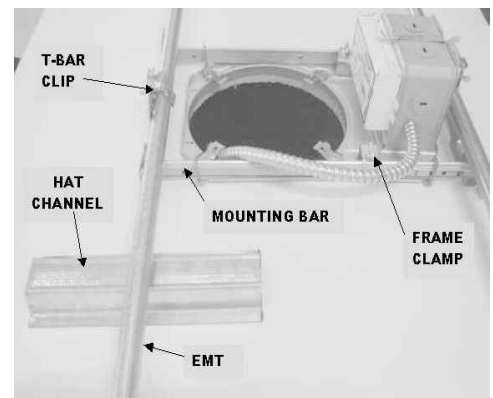

Figure C

**LIGHTOLIER®**

**LIGHTOLIER A GENIE COMPANY**  
631 Airport Road. Fall River. MA 02720

**INSTALLATION PROCEDURE FOR:  
1001FEM, 1101FEM and 1101FEL Series Frame-In Kits  
with Emergency Backup**

INSTRUCTION SHEET NO.

**IS:1101FEM**

**IMPORTANT SAFEGUARDS – READ AND FOLLOW ALL SAFETY INSTRUCTIONS**

D1007

Page 4 of 4

**ADDITIONAL INSTALLATION INSTRUCTIONS FOR LUMINAIRES WITH EMERGENCY BACKUP**

**When installing or servicing LUMINAIRES equipped with EMERGENCY BACKUP, basic safety precautions should always be followed including the following:**

1. Do not install insulation above or within 3" (76mm) of any part of luminaire.
2. Turn off AC power before proceeding.
3. Be sure all electrical connections are complete before Unit Connector (located in the JUNCTION BOX) is connected.
4. Do not use outdoors.
5. Do not let power supply cords touch hot surfaces.
6. Do not mount near gas or electric heaters.
7. Use caution when servicing. Do not incinerate or mutilate; may burst or release toxic material. Do not short circuit; may cause burns. Battery acid can cause burns to skin and eyes. If acid is spilled on skin or eyes, flush acid with fresh water and contact a physician immediately.
8. Equipment should be mounted in locations and at a height where it will not readily be subjected to tampering by unauthorized personnel.
9. The use of accessory equipment not recommended by the manufacturer may cause an unsafe condition.
10. Do not use this equipment for other than intended use.
11. This unit has more than one power supply connection point. To reduce the risk of electric shock – disconnect both normal and emergency power supplies before servicing.
12. Before servicing, to prevent electric shock, make sure the unit connection of the EMERGENCY PACK (located in the JUNCTION BOX) is disconnected, make certain that the switched (if the luminaire is switched) and the un-switched line to the EMERGENCY PACK is turned off at the main power supply.

**SERVICING SHOULD BE PERFORMED BY QUALIFIED SERVICE PERSONNEL ONLY.**

**SWITCH/INDICATOR LIGHT BOX MOUNTING:**

1. Cut 2-5/8" x 3-3/4" (66.7mm x 95.3mm) hole in ceiling/ceiling tile for Switch/Indicator Light box.
2. Pull down Switch/Indicator Light box and clamp onto ceiling by tightening screws on side of box. (Figure A)
3. Fasten Trim Plate to Switch box with nut provided. (Figure B)

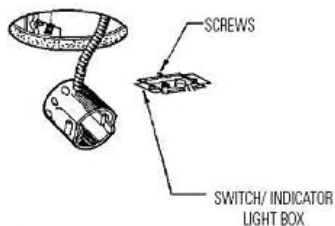

**Figure A**

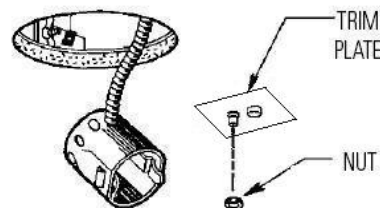

**Figure B**

**INTEGRAL SWITCH/INDICATOR LIGHT TO REFLECTOR MOUNTING: (1101F2642UEL)**

1. With fixture mounted in ceiling, bring test switch and socket cup (2 separate conduits) through aperture hole in ceiling.
2. Remove nut from test switch connector and insert connector through 7/8" hole on reflector.
3. Fix test switch to reflector by securing nut to test switch connector. Attach socket cup to trim.

**OPERATION:** When the A.C. power is applied, the charging indicator light is illuminated, indicating that the battery is being charged. When the power fails, the emergency lighting ballast automatically switches to emergency operation, keeping one lamp on reduced output for 90 minutes.

**MAINTENANCE:** Although no routine maintenance is required to keep the emergency lighting ballast functional, it should be checked periodically to ensure that it is working. The following schedule is recommended.

1. Visually inspect the charging indicator light monthly.
2. It should be illuminated. Test the emergency operation of the luminaire once every 3 months. One lamp should operate at reduced output.
3. Conduct a 90 minute discharge test once a year. One lamp should operate at reduced output for 90 minutes.

**LIGHTOLIER®**

**LIGHTOLIER® A GENIYE COMPANY**  
631 Airport Road. Fall River. MA 02720

## Free Manuals Download Website

<http://myh66.com>

<http://usermanuals.us>

<http://www.somanuals.com>

<http://www.4manuals.cc>

<http://www.manual-lib.com>

<http://www.404manual.com>

<http://www.luxmanual.com>

<http://aubethermostatmanual.com>

Golf course search by state

<http://golfingnear.com>

Email search by domain

<http://emailbydomain.com>

Auto manuals search

<http://auto.somanuals.com>

TV manuals search

<http://tv.somanuals.com>