

# VR PARABOLIC VRA1G8LS132

## Features

- Meets IES RP1 for lighting VDT areas with normal use.
- 67.9% efficient (T8).
- 1.9 spacing mounting ratio.
- Semi-specular low iridescence pre-anodized louver.
- Vertical grain on louver eliminates reflected lamp image on cross baffle.
- Louver frame with integral positive light stop.
- Spring loaded latches (self centering).
- Reversible louver hinging.
- Louver has protective dust guard.
- Only 6-5/8" deep body.
- Black housing exterior for cooler ballast operating temperature.
- Turned-in edges for safe handling.
- Built-in earthquake clip (pat. no. 5,072,344).
- UL-Listed twin knockout access plate.
- Air closure strips (optional).
- Construction to meet NYC Code or Chicago Plenum is available.



## MOUNTING METHODS

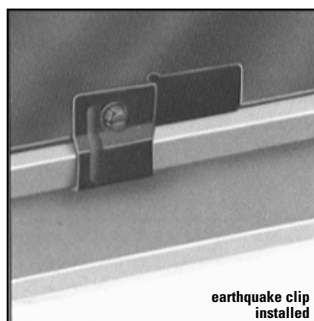
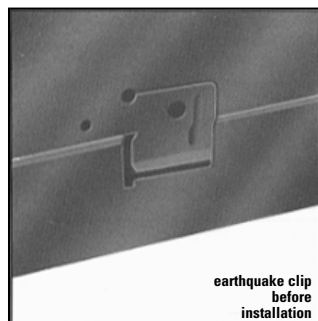
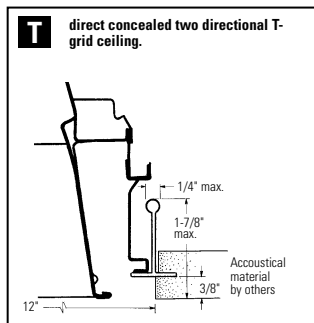
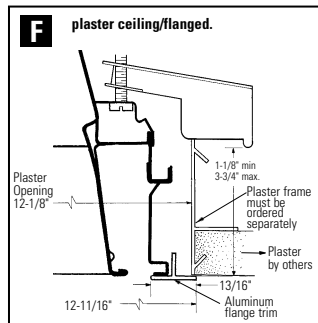
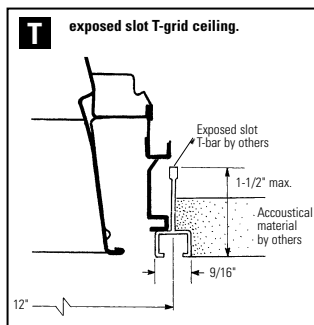
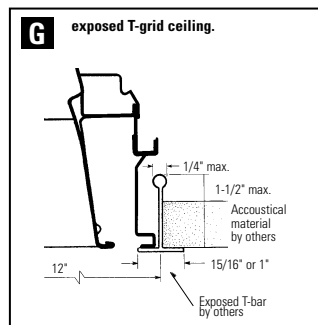

## DIMENSIONS

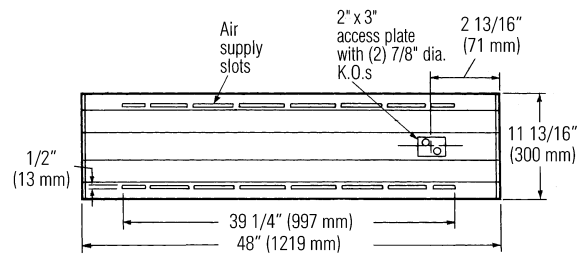
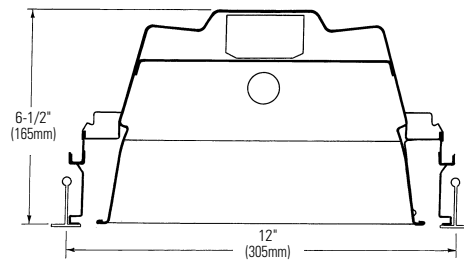

## Job Information

## Type:

**Job Name:**

**Cat. No.:**

**Lamp(s):**

**Volts/Ballast:**

Lightolier a Genlyte Thomas Company

www.lightolier.com

Technical Information: (978) 657-7600 • Fax (978) 658-0595  
 631 Airport Road, Fall River, MA 02720 • (508) 679-8131 • Fax (508) 674-4710

We reserve the right to change details of design, materials and finish.

© 2002 Genlyte Thomas Group LLC (Lightolier Division)

A0902

**SECTION 2/Folio G05-36 REV. A**



# VR PARABOLIC VRA1G8LS132

## 1'x4' RECESSED FLUORESCENT, 3" DEEP, 8 CELL (1 ROW) PARABOLIC LOUVER STATIC OR AIR SUPPLY/RETURN, IES RP1 FOR NORMAL VDT USE

### PHOTOMETRY

MODEL NO. VRA1G8LS132120SO

LER = FP - 55.0 IW - 30.7 BF - 0.88  
Comparative yearly lighting energy cost per 1000 lumens = \$4.36

**LTL LUMINAIRE TESTING LABORATORY**  
905 Harrison Street • Allentown, PA 18103 • (610) 770-1044 • Fax (610) 770-8912

LTL NUMBER: 03317 DATE: 1-8-1997  
PREPARED FOR: LIGHTOLIER INC.  
CATALOG NUMBER: VRA1G8LS132SO  
LUMINAIRE: FORMED STEEL 1X4 HOUSING, WHITE ENAMEL REFLECTOR, 8 CELL, 2.75" DEEP, SEMI-SPECULAR ALUMINUM LOUVER.  
BALLAST: ONE MOTOROLA M1-RN-T8-1LL-120  
LAMPS: ONE SYLVANIA F032/T41 RATED AT 2850 LUMENS.  
MOUNTING: RECESSED  
LUMEN TO CANDELA RATIO USED = 9.18  
TOTAL INPUT WATTS = 30.7 AT 120.0 VOLTS  
THE 0 DEGREE PLANE IS PARALLEL WITH THE LAMPS.

**CANDELA DISTRIBUTION**

| ANGLE | 0.0 | 22.5 | 45.0 | 67.5 | 90.0 |
|-------|-----|------|------|------|------|
| 0     | 649 | 649  | 649  | 649  | 649  |
| 15    | 618 | 632  | 655  | 675  | 683  |
| 25    | 567 | 598  | 672  | 759  | 799  |
| 35    | 489 | 561  | 748  | 959  | 1038 |
| 45    | 385 | 522  | 789  | 761  | 503  |
| 55    | 254 | 398  | 399  | 260  | 253  |
| 65    | 28  | 68   | 89   | 100  | 100  |
| 75    | 0   | 6    | 6    | 7    | 5    |
| 85    | 0   | 0    | 0    | 0    | 0    |
| 90    | 0   | 0    | 0    | 0    | 0    |

**FLUX**

| ANGLE | 0.0 | 22.5 | 45.0 | 67.5 | 90.0 |
|-------|-----|------|------|------|------|
| 0     | 62  | 186  | 316  | 474  | 503  |
| 15    | 62  | 186  | 316  | 474  | 503  |
| 25    | 62  | 186  | 316  | 474  | 503  |
| 35    | 62  | 186  | 316  | 474  | 503  |
| 45    | 62  | 186  | 316  | 474  | 503  |
| 55    | 62  | 186  | 316  | 474  | 503  |
| 65    | 62  | 186  | 316  | 474  | 503  |
| 75    | 62  | 186  | 316  | 474  | 503  |
| 85    | 62  | 186  | 316  | 474  | 503  |
| 90    | 62  | 186  | 316  | 474  | 503  |

**ZONAL LUMEN SUMMARY**

| ZONE   | LUMENS | %LAMP | %FIXT |
|--------|--------|-------|-------|
| 0-30   | 564    | 19.8  | 29.1  |
| 0-40   | 1038   | 36.4  | 53.6  |
| 0-60   | 1837   | 64.5  | 95.0  |
| 0-90   | 1935   | 67.9  | 100.0 |
| 90-180 | 0      | 0.0   | 0.0   |
| 0-180  | 1935   | 67.9  | 100.0 |

**TOTAL LUMINAIRE EFFICIENCY:** 67.9%  
**TOTAL REFLECTANCE OF PAINT:** 87.8%  
**CIE TYPE:** DIRECT  
**PLANE:** 0-DEG 90-DEG  
**SPACING CRITERIA:** 1.2 1.9  
**SHIELDING ANGLES:** 2.7 3.6  
**LUMINOUS LENGTH:** 46.125 9.500

**LUMINANCE IN CANDELA PER SQUARE METER**

| ANGLE  | AVERAGE | AVERAGE |        |
|--------|---------|---------|--------|
| IN DEG | 0-DEG   | 45-DEG  | 90-DEG |
| 0      | 2296    | 2296    | 2296   |
| 45     | 1926    | 3827    | 3807   |
| 55     | 1566    | 2460    | 1560   |
| 65     | 234     | 745     | 837    |
| 75     | 82      | 82      | 68     |
| 85     | 0       | 0       | 0      |

TESTED BY: BILL GRATHER  
CHECKED BY: MIKE GRATHER

THIS REPORT BASED ON LM-41 AND OTHER PERTINENT IES PROCEDURES.

### coefficients of utilization — zonal cavity method

| RF                | 20 |    |    | 20 |    |    | 20 |    |    |    |
|-------------------|----|----|----|----|----|----|----|----|----|----|
| RC                | 80 |    |    | 50 |    |    | 30 |    |    |    |
| RW                | 70 | 50 | 30 | 50 | 30 | 10 | 50 | 30 | 10 |    |
| room cavity ratio | 1  | 76 | 73 | 71 | 69 | 67 | 66 | 67 | 65 | 64 |
|                   | 2  | 71 | 66 | 63 | 63 | 60 | 58 | 61 | 59 | 57 |
|                   | 3  | 66 | 60 | 55 | 57 | 53 | 51 | 55 | 52 | 50 |
|                   | 4  | 61 | 54 | 49 | 51 | 47 | 44 | 50 | 46 | 44 |
|                   | 5  | 56 | 48 | 43 | 46 | 42 | 38 | 45 | 41 | 38 |
|                   | 6  | 51 | 43 | 38 | 41 | 37 | 33 | 40 | 36 | 33 |
|                   | 7  | 47 | 39 | 33 | 37 | 32 | 29 | 36 | 32 | 29 |
|                   | 8  | 43 | 34 | 29 | 33 | 28 | 25 | 32 | 28 | 25 |
|                   | 9  | 39 | 30 | 25 | 29 | 24 | 21 | 29 | 24 | 21 |
|                   | 10 | 36 | 27 | 22 | 26 | 22 | 18 | 26 | 21 | 18 |

### visual comfort probability

| room size |     | ceiling height |      |      |      | ceiling height |      |      |      |
|-----------|-----|----------------|------|------|------|----------------|------|------|------|
| W         | L   | 8.5            | 10.0 | 13.0 | 16.0 | 8.5            | 10.0 | 13.0 | 16.0 |
| 20        | 20  | 88             | 85   | 80   | 85   | 87             | 82   | 80   | 79   |
| 20        | 30  | 89             | 87   | 84   | 81   | 89             | 85   | 80   | 77   |
| 20        | 40  | 89             | 87   | 86   | 84   | 89             | 85   | 83   | 78   |
| 20        | 60  | 89             | 88   | 87   | 86   | 89             | 85   | 83   | 81   |
| 30        | 20  | 90             | 88   | 82   | 84   | 88             | 86   | 81   | 79   |
| 30        | 30  | 91             | 89   | 85   | 80   | 90             | 88   | 81   | 77   |
| 30        | 40  | 91             | 89   | 87   | 83   | 90             | 88   | 84   | 78   |
| 30        | 60  | 91             | 89   | 87   | 85   | 90             | 88   | 84   | 80   |
| 30        | 80  | 91             | 89   | 87   | 84   | 89             | 88   | 84   | 81   |
| 40        | 20  | 91             | 88   | 84   | 85   | 88             | 86   | 83   | 81   |
| 40        | 30  | 91             | 89   | 87   | 81   | 90             | 88   | 83   | 78   |
| 40        | 40  | 91             | 89   | 88   | 84   | 90             | 88   | 85   | 79   |
| 40        | 60  | 91             | 89   | 88   | 84   | 89             | 88   | 86   | 81   |
| 40        | 80  | 91             | 89   | 88   | 84   | 90             | 88   | 86   | 81   |
| 40        | 100 | 91             | 89   | 88   | 84   | 90             | 88   | 86   | 81   |
| 60        | 30  | 91             | 89   | 88   | 83   | 90             | 88   | 83   | 80   |
| 60        | 40  | 91             | 89   | 88   | 85   | 89             | 88   | 85   | 81   |
| 60        | 60  | 91             | 89   | 89   | 86   | 90             | 88   | 86   | 83   |
| 60        | 80  | 91             | 89   | 89   | 86   | 90             | 88   | 86   | 83   |
| 60        | 100 | 91             | 89   | 89   | 86   | 90             | 88   | 86   | 83   |
| 100       | 40  | 91             | 89   | 89   | 85   | 90             | 88   | 86   | 81   |
| 100       | 60  | 91             | 89   | 89   | 86   | 90             | 88   | 86   | 83   |
| 100       | 80  | 91             | 89   | 89   | 86   | 90             | 88   | 86   | 83   |
| 100       | 100 | 91             | 89   | 89   | 86   | 90             | 88   | 86   | 83   |

### ORDERING INFORMATION

Explanation of Catalog Number. Example: VRA1G8LS132120SOGLR

|                          |   |  |  |  |   |  |   |
|--------------------------|---|--|--|--|---|--|---|
| BLANK                    | VR  | 1  | 8  | S  | 1   | 120 or 277   | OPTIONS   |
| Standard<br>N = NYC Code | VR:<br>3" Deep<br>Pre-anodized<br>Aluminum<br>Louver<br>for normal<br>VDT use | 1:<br>3" Deep<br>Pre-anodized<br>Aluminum<br>Louver<br>for normal<br>VDT use | 8:<br>8 Cells  | S:<br>Single<br>White<br>Reflector   | 1:<br>1 Lamp<br>Quantity  | VOLTAGE:<br>120 or 277   | OPTIONS:<br>Add appropriate<br>suffix to catalog<br>no, ie: (GLR) |
|                          |   |  | CEILING TYPE:<br>G= Grid (lay-in T bar)<br>F= Flanged (overlap)<br>Z spline and<br>plaster frame<br>T= Slot grid or<br>two-directional<br>concealed T<br>(see options) | LOUVER<br>FINISH:<br>L=Low<br>Iridescence<br>Semi-specular<br>(standard)<br>P=Low<br>Iridescence<br>specular | LAMP/<br>FIXTURE<br>LENGTH:<br>32=T8<br>34=T12<br>(Nominal 48") | BALLAST TYPE:<br>LE<br><20THD<br>SO*<br>PS<br>*Instant Start Standard<br>Other dimming options, consult factory. |   |

### OPTIONS & ACCESSORIES

- ACCESS PLATE:** Top Wiring access plate is shipped with fixture as standard. When access plates are required in advance for wiring convenience, specify separately. Order Catalog Number: **ACP CSP**.
- ELECTRICAL WIRING OPTIONS:** Consult factory.
- FUSING:** Internal fast-blow fusing. SUFFIX: **GLR**. Internal slow-blow fusing. SUFFIX: **GMF**.
- RADIO INTERFERENCE FILTER:** 120 or 277 volt, 50 or 60 Hz. One per fixture standard. SUFFIX: **RF**.
- CONTINUOUS ROW INSTALLATION:** For F type fixtures, half-width flanges are required between fixtures. Order Catalog Number: **1FCTRIM** (each joint).
- SPLAY TRIM:** For T ceiling type only. SUFFIX: **CTZ14 S2 SPLAY TRIM**.
- AIR CLOSURE STRIP:** SUFFIX **ACS4** (factory installed).
- DRYWALL KIT:** Order Catalog Number: **FK91X4**. Request Folio OA30-10.
- CHICAGO PLENUM:** SUFFIX: **CP**.

### SPECIFICATIONS

**PERFORMANCE:** In an installation of 1 lamp 32W luminaires in a room cavity ratio of 1, reflectance 80% ceiling, 50% wall, 20% floor, the C.U. shall not be less than .73 with a spacing to mounting ratio of 1.9 perpendicular to the lamps. To meet IES RP1 recommended (basic) requirements for VDT areas the VCP (visual comfort probability) shall not be less than 90 either crosswise or lengthwise and the maximum average brightness at 65°, 75° and 85° shall not exceed 837, 82 and

### SPECIFICATIONS (continued)

0 candelas per square meter respectively in the 0°, 45° and 90° horizontal planes. Candelas at Nadir (0°) not to exceed 649.

**AIR HANDLING:** (VRA only) side air passages for air supply or air return. Optional side closure strips. Air return is also provided through the lamp compartment through fixture body ends.

**MATERIALS:** Chassis parts are die-formed embossed cold rolled steel. Housing is embossed for rigidity with all edges turned-in for safe handling.

**LOUVER:** Pre-anodized aluminum (Coilzak® or equal).

**FINISH:** Louver—semi-specular low iridescence pre-anodized reflector sheet. Cavity—white baked polyester minimum reflectance 86%. Phosphate under-coating. Chassis exterior—black baked polyester enamel.

**ELECTRICAL:** Thermally protected class "P" ballast C.B.M. approved, non PCB. If K.O. is within 3" of ballast, use wire suitable for at least 90°.

**LABELS:** I.B.E.W./UL and C-UL.

### Job Information Type:

**Lightolier** a Genlyte Thomas Company www.lightolier.com  
Technical Information: (978) 657-7600 • Fax (978) 658-0595  
631 Airport Road, Fall River, MA 02720 • (508) 679-8131 • Fax (508) 674-4710  
We reserve the right to change details of design, materials and finish.  
© 2002 Genlyte Thomas Group LLC (Lightolier Division)  
A0902 **SECTION 2/Folio G05-36 REV. A**

# LIGHTOLIER

## Free Manuals Download Website

<http://myh66.com>

<http://usermanuals.us>

<http://www.somanuals.com>

<http://www.4manuals.cc>

<http://www.manual-lib.com>

<http://www.404manual.com>

<http://www.luxmanual.com>

<http://aubethermostatmanual.com>

Golf course search by state

<http://golfingnear.com>

Email search by domain

<http://emailbydomain.com>

Auto manuals search

<http://auto.somanuals.com>

TV manuals search

<http://tv.somanuals.com>