

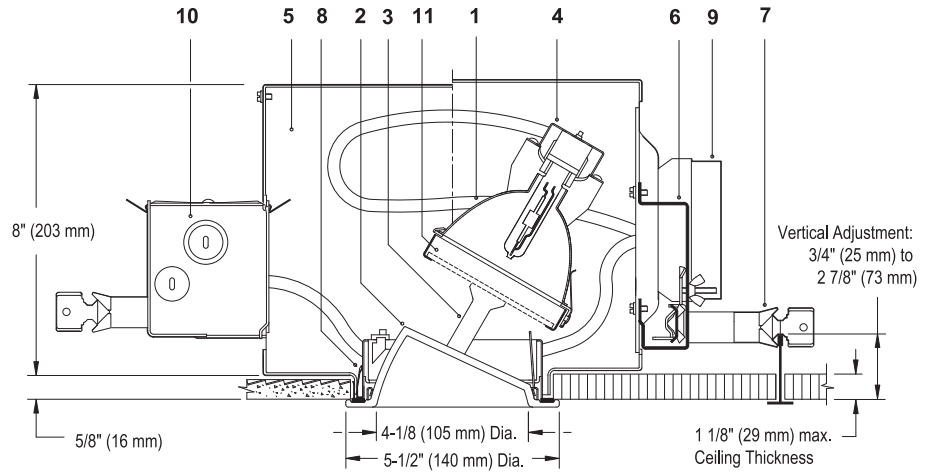

Calculite® HID Adjustable Accent **C4T4GA-MHT4RS**

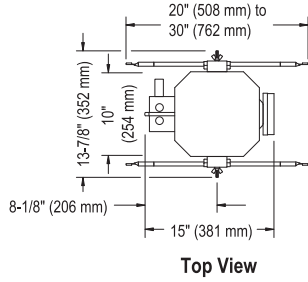

Ceiling Cutout: 5 1/8" (130mm) Dia.

For Complete Fixture Order: Glasslite Trim Kit + Spot Upper Reflector (MHT4RS) + Frame-In Kit. Each Sold Separately.

Glasslite Trim Kit + Spot Upper Reflector	Frame-In Kit	Lamp
C4T4GA + MHT4RS (Spot Upper Reflector) Etched glass, with matching flange.	C4A20T4E1 Electronic 120V	20W T4.5 Ceramic MH
	C4A20T4E2 Electronic 277V	20W T4.5 Ceramic MH
	C4A39T4E1 Electronic 120V	39W T4.5 Ceramic MH
	C4A39T4E2 Electronic 277V	39W T4.5 Ceramic MH
	C4A70T4E1 Electronic 120V	70W T4.5 Ceramic MH
	C4A70T4E2 Electronic 277V	70W T4.5 Ceramic MH

Features

- Spot Upper Reflector:** Specular faceted aluminum; provides 12° beam. Interchangeable with 25° Narrow Flood (MHT4RNF) and 40° Flood (MHT4RF); see spec sheets C4T4GA-MHT4RNF and C4T4GA-MHT4RF.
- Glasslite Trim Kit:** One piece borosilicate etched glass.
- Trim Kit Adjustment Mechanism:** Provides 35° vertical tilt, 360° horizontal rotation; lockable. Patented EZ-Aim Helical Drive System provides fast and accurate hot aiming with Philips screwdriver.
- Socket Housing:** Galvanized steel, pre-wired with G8.5 pulse rated socket. Snaps onto yoke for secure attachment without tools; unitized construction assures proper alignment of lamp to optics for consistent optical performance.
- Frame Housing:** Steel, 0.029" (Z2-Ga.), matte black finish. Removable cover for top re-lamping.
- Frame Vertical Adjustment Mechanism:** Accommodates mounting to virtually any ceiling system using pre-installed mounting bars, or 1/2" EMT tubing (by others). Single locking feature secures all adjustments. Alignment holes and markings allow fixture to be pre-set prior to installation. Final adjustment can be made from below from inside fixture.
- Mounting Bars:** Galvanized steel, 0.048" (18-ga.), pre-installed telescoping bars extend to 30" long and lock securely into position. Built-in locking tabs provide positive attachment to common T-bar systems. Self-centering feature simplifies installation in 24" O.C. grid systems. Attaches to steel or wood joists without accessories.
- Retention Springs:** Rust resistant springs secure trim for quick, tool-less installation.
- Ballast / Cover Assembly:** Accessible from below and removable without tools for inspection and ballast replacement.
- Junction Box:** 0.059" (16-ga.) galvanized steel. UL listed for 8 No. 12 AWG, 90° C through branch circuit conductors. Allows inspection from below.
- Accessory Holder:** Sold separately catalog # CAH4; die-formed steel, matte black finish, slide-in installation. Accepts up to two 3 3/4" dia. media.
- Thermal Protector:** (Not Shown) Meets NEC and UL requirements. Do not install insulation above nor within 3" (76mm) of any part of the luminaire.

Electrical

Electronic Ballast: 120 or 277V, 50/60 Hz., enclosed, high power factor, T.H.D. <15%, thermally and transient protected, RMI/RFI complies with FCC Part 18 non-consumer limits, shut-down circuit at end of lamp life, sound rating "A", -5°F minimum starting temperature, Type 1 Outdoor rating.

Ballast	ANSI Code	Voltage	Max. Amps	Input Watts
20W MH	M156	120/277	0.21/0.10	23
39W MH	M130	120/277	0.39/0.17	44
70W MH	M139	120/277	0.67/0.29	78

Options and Accessories

Chicago Plenum: Consult Factory

Labels

UL (Suitable for Wet Locations), CSA, I.B.E.W.

Job Information	Type:
Job Name:	
Cat. No.:	
Lamp(s):	
Notes:	

Lightolier a Genlyte Thomas Company www.lightolier.com
631 Airport Road, Fall River, MA 02720 • (508) 679-8131 • Fax (508) 674-4710
We reserve the right to change details of design, materials and finish.

© 2004 Genlyte Thomas Company (Lightolier Division) • A0504

LIGHTOLIER®



(FC) is initial footcandles at center of beam. Beam length (L) and beam width (W) are to where the candlepower is reduced to 50% of the center beam candlepower. (C) is the distance to the center of the beam.

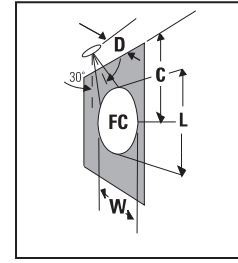
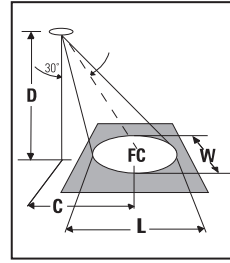

CANDLEPOWER DISTRIBUTION

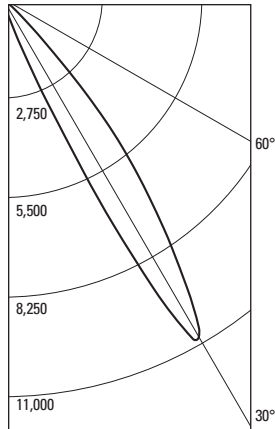

ANGLE	WALL
0	22
5	41
10	127
15	216
20	1007
25	5286
30	10820
35	7757
40	4435
45	1178
50	187
55	41
60	10
65	5
70	0
75	0
80	0
85	0
90	0

20W T4.5 CERAMIC MH, SPOT UPPER REFLECTOR

AIMED 30 deg. TOWARD WALL

LAMP: T4.5 CERAMIC MH, GE
LUMEN RATING: 1700 LMS.

CBCP: 10820
Beam Angle: 13
AROMAT ELECTRONIC BALLAST 20W

DATE: APR 2, 2004
CERTIFIED TEST REPORT NO. 18680

COMPUTED BY LSI PROGRAM
TEST-LITE

**30° Aiming Angle
Horizontal Surface**

D	C	FC	L	W
6'	3.5'	195	1.8'	1.6'
8'	4.6'	110	2.4'	2.1'
10'	5.8'	70	3.1'	2.6'
12'	6.9'	49	3.7'	3.2'
15'	8.7'	31	4.6'	3.9'

**30° Aiming Angle
Vertical Surface**

D	C	FC	L	W
2'	3.5'	338	1.9'	0.9'
3'	5.2'	150	2.8'	1.4'
4'	6.9'	85	3.8'	1.8'
6'	10.4'	38	5.7'	2.7'
8'	13.9'	21	7.6'	3.6'

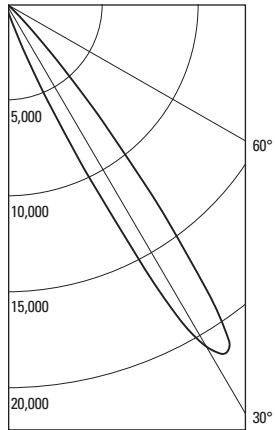

ANGLE	WALL
0	72
5	101
10	236
15	541
20	2073
25	8817
30	20419
35	18264
40	6846
45	1609
50	365
55	84
60	36
65	24
70	19
75	12
80	7
85	0
90	0

39W T4.5 CERAMIC MH, SPOT UPPER REFLECTOR

AIMED 30 deg. TOWARD WALL

LAMP: T4.5 CERAMIC MH, PHILIPS
LUMEN RATING: 3400 LMS.

CBCP: 20419
Beam Angle: 13
AROMAT ELECTRONIC BALLAST 39W

DATE: APR 13, 2004
CERTIFIED TEST REPORT NO. 18681

COMPUTED BY LSI PROGRAM
TEST-LITE

**30° Aiming Angle
Horizontal Surface**

D	C	FC	L	W
8'	4.6'	207	2.4'	2.1'
10'	5.8'	133	3.1'	2.6'
12'	6.9'	92	3.7'	3.2'
15'	8.7'	59	4.6'	3.9'
20'	11.5'	33	6.1'	5.3'

**30° Aiming Angle
Vertical Surface**

D	C	FC	L	W
3'	5.2'	284	2.8'	1.4'
4'	6.9'	160	3.8'	1.8'
6'	10.4'	71	5.7'	2.7'
8'	13.9'	40	7.6'	3.6'
12'	20.8'	18	11.4'	5.5'

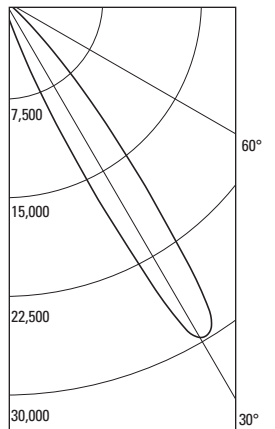

ANGLE	WALL
0	127
5	216
10	619
15	1507
20	5042
25	15782
30	29566
35	24248
40	11359
45	4236
50	1253
55	231
60	67
65	30
70	15
75	15
80	0
85	0
90	0

70W T4.5 CERAMIC MH, SPOT UPPER REFLECTOR

AIMED 30 deg. TOWARD WALL

LAMP: T4.5 CERAMIC MH, PHILIPS
LUMEN RATING: 6200 LMS.

CBCP: 29566
Beam Angle: 14
AROMAT ELECTRONIC BALLAST 70W

DATE: APR 2, 2004
CERTIFIED TEST REPORT NO. 18682

COMPUTED BY LSI PROGRAM
TEST-LITE

**30° Aiming Angle
Horizontal Surface**

D	C	FC	L	W
8'	4.6'	300	2.6'	2.3'
10'	5.8'	192	3.3'	2.8'
12'	6.9'	133	3.9'	3.4'
15'	8.7'	85	4.9'	4.3'
20'	11.5'	48	6.6'	5.7'

**30° Aiming Angle
Vertical Surface**

D	C	FC	L	W
3'	5.2'	411	3.1'	1.5'
4'	6.9'	231	4.1'	2.0'
6'	10.4'	103	6.2'	2.9'
8'	13.9'	58	8.2'	3.9'
12'	20.8'	26	12.3'	5.9'

Job Information **Type:**

Lightolier a Genlyte Thomas Company www.lightolier.com
631 Airport Road, Fall River, MA 02720 • (508) 679-8131 • Fax (508) 674-4710
We reserve the right to change details of design, materials and finish.

© 2004 Genlyte Thomas Group LLC (Lightolier Division) • A0504



Free Manuals Download Website

<http://myh66.com>

<http://usermanuals.us>

<http://www.somanuals.com>

<http://www.4manuals.cc>

<http://www.manual-lib.com>

<http://www.404manual.com>

<http://www.luxmanual.com>

<http://aubethermostatmanual.com>

Golf course search by state

<http://golfingnear.com>

Email search by domain

<http://emailbydomain.com>

Auto manuals search

<http://auto.somanuals.com>

TV manuals search

<http://tv.somanuals.com>