

## Features

- Efficiency 58.5%.
- Dual swing down microperforated lamp shields separated by luminous strip for easy relamping and maintenance.
- Alter soft white film on inside of mesh conceals lamp image providing balance between reflected and direct light.
- Fully recessed luminaire and with two separate lamp compartments.
- 95% Reflective Alter soft white paint finish.
- Specular interior reflector.
- One piece body for easy installation.
- Exclusive socket locks lamp into place.
- Easy access to ballast through lamp compartment.
- Fits standard T-Grid ceilings.
- Optional acrylic drop-down visual element.



## Mounting Methods / Features

### Ceiling compatibility

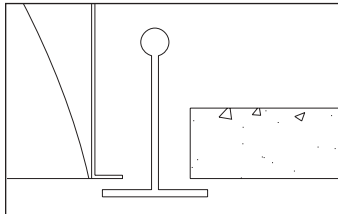

Suited to standard exposed T-grid ceilings

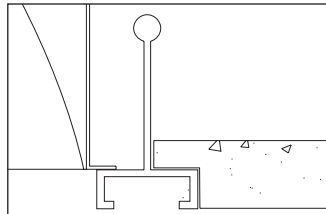

Suited to standard exposed Slot T-grid ceilings

### Swing down optical system for easy relamping and maintenance



Microperforated mesh lamp shields

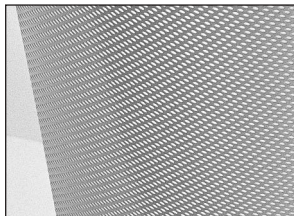

Also available with solid opaque swing-down lamp shield



## Dimensions

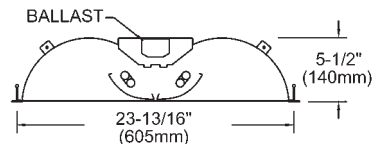
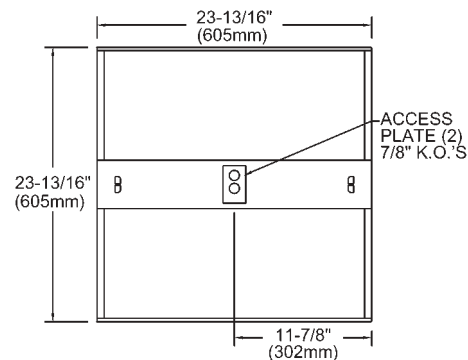

## Job Information

## Type:

**Job Name:**

**Cat. No.:**

**Lamp(s):**

**Volts/Ballast:**

Lightolier a Genlyte Thomas Company

www.lightolier.com

Technical Information: (978) 657-7600 • Fax (978) 658-0595

631 Airport Road, Fall River, MA 02720 • (508) 679-8131 • Fax (508) 674-4710

We reserve the right to change details of design, materials and finish.

© 2002 Genlyte Thomas Group LLC (Lightolier Division)

A0902

Section 5 / Folio L10-25

# ALTER SOFT LIGHTS QVS2GPFOS2FT 2X40W

2' X 2' RECESSED DIRECT/INDIRECT FLUORESCENT 2 LAMP, TT5 BI-TUBE, 5 1/2" DEEP MICROPERFORATED MESH LAMP SHIELD, STATIC

## Photometry

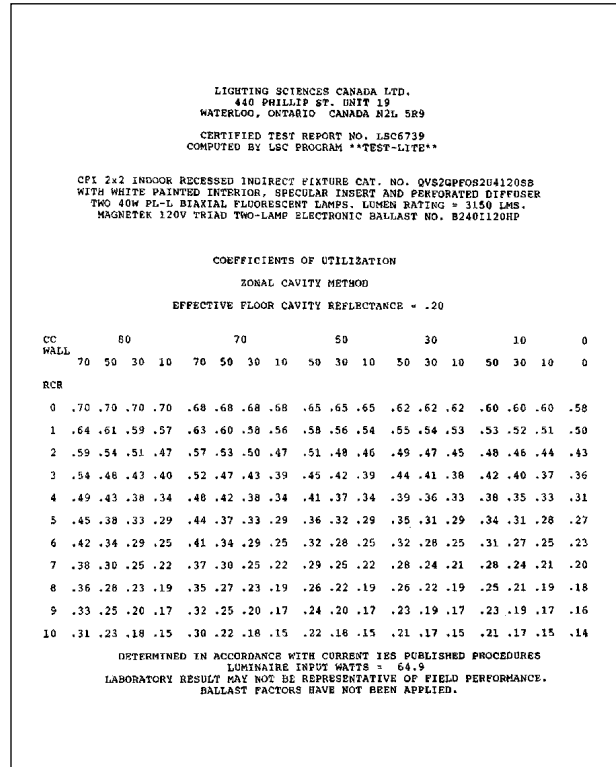
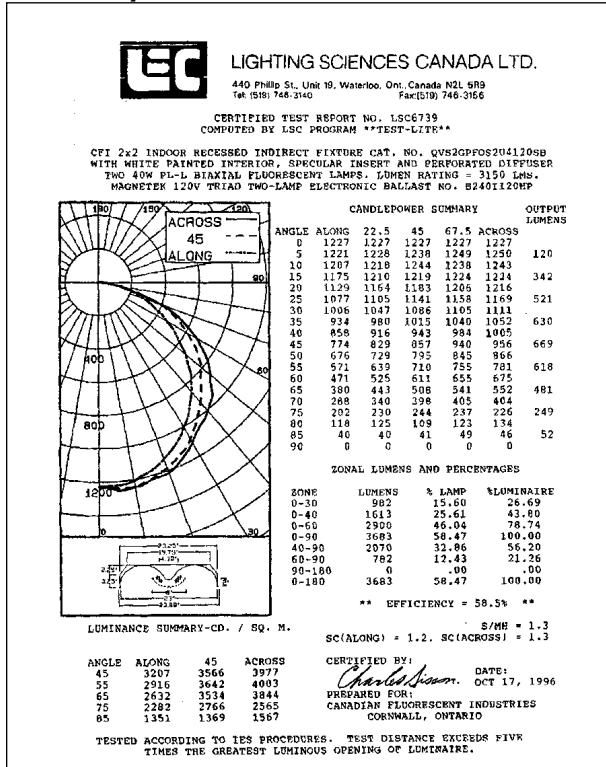

## Ordering Information Explanation of Catalog Number Example: QVS2GPFOS2FT120BE

<b>QVS</b>	<b>2</b>	<b>G</b>			<b>2</b>	<b>FT</b>			
<b>QUALITY VISUAL STATIC</b> Recessed direct indirect soft light optical system	<b>FIXTURE WIDTH:</b> 2'	<b>CEILING TYPE:</b> Standard exposed T-grid ceilings			<b>LAMP QUANTITY</b>	<b>VOLTAGE:</b> 120V 277V 347V			<b>OPTIONS:</b> R = Radio Interference Filter O = Emergency Lighting System (for Canada) N = Emergency Lighting System (for U.S.)
					<b>CLEAR POLISHED ACRYLIC DROP DOWN VISUAL ELEMENT:</b> OS = Open slot (no acrylic) OP = One Piece (no center slot) GC = Clear acrylic GG = Clear acrylic / Green projected color face GB = Clear acrylic / Blue projected color face GR = Clear acrylic / Red projected color face	<b>LAMP/FIXTURE LENGTH:</b> (Nominal 24") FT = TT5 Bi-Tube			<b>BALLAST:</b> BE = 50W Electronic TT5 RS BR = 40W Electronic TT5 RS BX = 40W Magnetic TT5 RS PB = 40W TT5 PowerSpec Dimming* PC = 50/55W TT5 PowerSpec Dimming* SB = 40W Generic Electronic TT5 *Not available in 347V.

## Specifications

**MATERIALS:** One piece chassis constructed from die formed 20 gauge cold rolled steel. Reflectors - 95% reflectance baked white acrylic matte paint finish. Specular aluminum interior reflector. Soft white acrylic film on inside of lamp shield conceals lamp image.

**FINISH:** Chassis exterior - phosphate undercoating, baked white acrylic matte paint finish.

**ELECTRICAL:** Rapid start HPF, thermally protected class "P" ballast (Bi-tube type). If K.O.s are within 3" of ballast use wire suitable for at least 90C.

**LABELS:** Listed by



## Job Information Type:

**Lightolier** a Genlyte Thomas Company [www.lightolier.com](http://www.lightolier.com)  
Technical Information: (978) 657-7600 • Fax (978) 658-0595  
631 Airport Road, Fall River, MA 02720 • (508) 679-8131 • Fax (508) 674-4710  
We reserve the right to change details of design, materials and finish.  
© 2002 Genlyte Thomas Group LLC (Lightolier Division)  
A0902 **Section 5 / Folio L10-25**

**LIGHTOLIER**

## Free Manuals Download Website

<http://myh66.com>

<http://usermanuals.us>

<http://www.somanuals.com>

<http://www.4manuals.cc>

<http://www.manual-lib.com>

<http://www.404manual.com>

<http://www.luxmanual.com>

<http://aubethermostatmanual.com>

Golf course search by state

<http://golfingnear.com>

Email search by domain

<http://emailbydomain.com>

Auto manuals search

<http://auto.somanuals.com>

TV manuals search

<http://tv.somanuals.com>