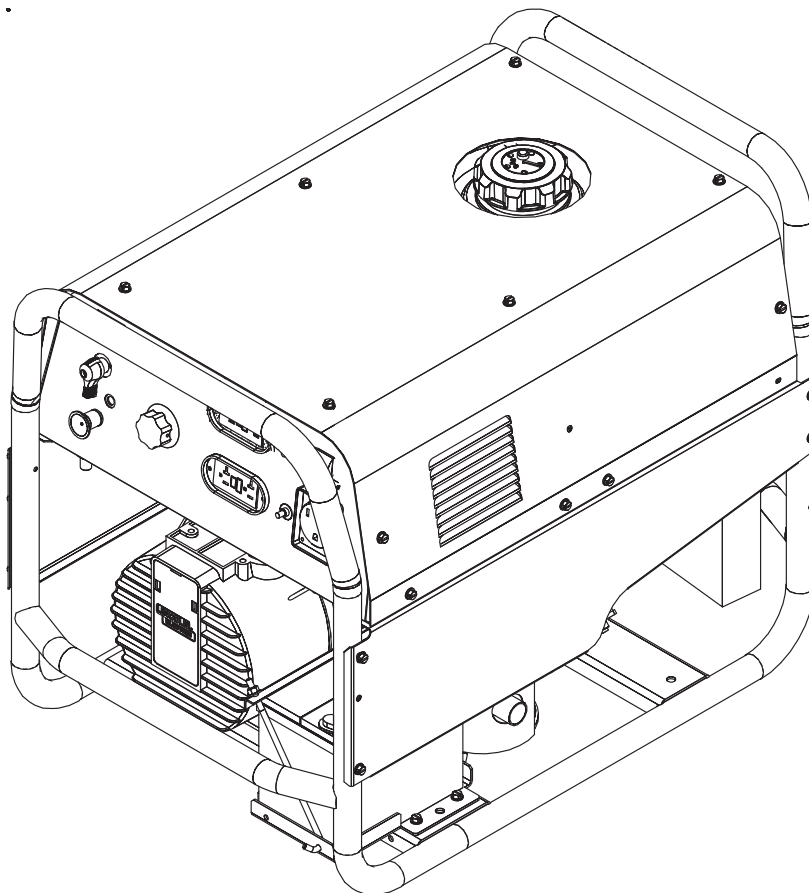

OUTBACK™ 185For use with machines having Code Numbers: **11516**

This manual covers equipment which is no longer in production by The Lincoln Electric Co. Specifications and availability of optional features may have changed.

Safety Depends on You

Lincoln arc welding and cutting equipment is designed and built with safety in mind. However, your overall safety can be increased by proper installation ... and thoughtful operation on your part. **DO NOT INSTALL, OPERATE OR REPAIR THIS EQUIPMENT WITHOUT READING THIS MANUAL AND THE SAFETY PRECAUTIONS CONTAINED THROUGHOUT.** And, most importantly, think before you act and be careful.

**OPERATOR'S MANUAL**

LINCOLN®
ELECTRIC

Copyright © Lincoln Global Inc.

- World's Leader in Welding and Cutting Products •
- Sales and Service through Subsidiaries and Distributors Worldwide •

Cleveland, Ohio 44117-1199 U.S.A. TEL: 216.481.8100 FAX: 216.486.1751 WEB SITE: www.lincolnelectric.comDownload from www.Somanuals.com. All Manuals Search And Download.

⚠ WARNING

⚠ CALIFORNIA PROPOSITION 65 WARNINGS ⚠

Diesel engine exhaust and some of its constituents are known to the State of California to cause cancer, birth defects, and other reproductive harm.

The Above For Diesel Engines

The engine exhaust from this product contains chemicals known to the State of California to cause cancer, birth defects, or other reproductive harm.

The Above For Gasoline Engines

ARC WELDING CAN BE HAZARDOUS. PROTECT YOURSELF AND OTHERS FROM POSSIBLE SERIOUS INJURY OR DEATH. KEEP CHILDREN AWAY. PACEMAKER WEARERS SHOULD CONSULT WITH THEIR DOCTOR BEFORE OPERATING.

Read and understand the following safety highlights. For additional safety information, it is strongly recommended that you purchase a copy of "Safety in Welding & Cutting - ANSI Standard Z49.1" from the American Welding Society, P.O. Box 351040, Miami, Florida 33135 or CSA Standard W117.2-1974. A Free copy of "Arc Welding Safety" booklet E205 is available from the Lincoln Electric Company, 22801 St. Clair Avenue, Cleveland, Ohio 44117-1199.

BE SURE THAT ALL INSTALLATION, OPERATION, MAINTENANCE AND REPAIR PROCEDURES ARE PERFORMED ONLY BY QUALIFIED INDIVIDUALS.



FOR ENGINE powered equipment.

1.a. Turn the engine off before troubleshooting and maintenance work unless the maintenance work requires it to be running.



1.b. Operate engines in open, well-ventilated areas or vent the engine exhaust fumes outdoors.



1.c. Do not add the fuel near an open flame welding arc or when the engine is running. Stop the engine and allow it to cool before refueling to prevent spilled fuel from vaporizing on contact with hot engine parts and igniting. Do not spill fuel when filling tank. If fuel is spilled, wipe it up and do not start engine until fumes have been eliminated.

1.d. Keep all equipment safety guards, covers and devices in position and in good repair. Keep hands, hair, clothing and tools away from V-belts, gears, fans and all other moving parts when starting, operating or repairing equipment.

1.e. In some cases it may be necessary to remove safety guards to perform required maintenance. Remove guards only when necessary and replace them when the maintenance requiring their removal is complete. Always use the greatest care when working near moving parts.



1.f. Do not put your hands near the engine fan. Do not attempt to override the governor or idler by pushing on the throttle control rods while the engine is running.

1.g. To prevent accidentally starting gasoline engines while turning the engine or welding generator during maintenance work, disconnect the spark plug wires, distributor cap or magneto wire as appropriate.



1.h. To avoid scalding, do not remove the radiator pressure cap when the engine is hot.



ELECTRIC AND MAGNETIC FIELDS may be dangerous

2.a. Electric current flowing through any conductor causes localized Electric and Magnetic Fields (EMF). Welding current creates EMF fields around welding cables and welding machines

2.b. EMF fields may interfere with some pacemakers, and welders having a pacemaker should consult their physician before welding.

2.c. Exposure to EMF fields in welding may have other health effects which are now not known.

2.d. All welders should use the following procedures in order to minimize exposure to EMF fields from the welding circuit:

2.d.1. Route the electrode and work cables together - Secure them with tape when possible.

2.d.2. Never coil the electrode lead around your body.

2.d.3. Do not place your body between the electrode and work cables. If the electrode cable is on your right side, the work cable should also be on your right side.

2.d.4. Connect the work cable to the workpiece as close as possible to the area being welded.

2.d.5. Do not work next to welding power source.



ELECTRIC SHOCK can kill.

3.a. The electrode and work (or ground) circuits are electrically “hot” when the welder is on. Do not touch these “hot” parts with your bare skin or wet clothing. Wear dry, hole-free gloves to insulate hands.

3.b. Insulate yourself from work and ground using dry insulation. Make certain the insulation is large enough to cover your full area of physical contact with work and ground.

In addition to the normal safety precautions, if welding must be performed under electrically hazardous conditions (in damp locations or while wearing wet clothing; on metal structures such as floors, gratings or scaffolds; when in cramped positions such as sitting, kneeling or lying, if there is a high risk of unavoidable or accidental contact with the workpiece or ground) use the following equipment:

- Semiautomatic DC Constant Voltage (Wire) Welder.
- DC Manual (Stick) Welder.
- AC Welder with Reduced Voltage Control.

3.c. In semiautomatic or automatic wire welding, the electrode, electrode reel, welding head, nozzle or semiautomatic welding gun are also electrically “hot”.

3.d. Always be sure the work cable makes a good electrical connection with the metal being welded. The connection should be as close as possible to the area being welded.

3.e. Ground the work or metal to be welded to a good electrical (earth) ground.

3.f. Maintain the electrode holder, work clamp, welding cable and welding machine in good, safe operating condition. Replace damaged insulation.

3.g. Never dip the electrode in water for cooling.

3.h. Never simultaneously touch electrically “hot” parts of electrode holders connected to two welders because voltage between the two can be the total of the open circuit voltage of both welders.

3.i. When working above floor level, use a safety belt to protect yourself from a fall should you get a shock.

3.j. Also see Items 6.c. and 8.



ARC RAYS can burn.

4.a. Use a shield with the proper filter and cover plates to protect your eyes from sparks and the rays of the arc when welding or observing open arc welding. Headshield and filter lens should conform to ANSI Z87.1 standards.

4.b. Use suitable clothing made from durable flame-resistant material to protect your skin and that of your helpers from the arc rays.

4.c. Protect other nearby personnel with suitable, non-flammable screening and/or warn them not to watch the arc nor expose themselves to the arc rays or to hot spatter or metal.



FUMES AND GASES can be dangerous.

5.a. Welding may produce fumes and gases hazardous to health. Avoid breathing these fumes and gases. When welding, keep your head out of the fume. Use enough ventilation and/or exhaust at the arc to keep fumes and gases away from the breathing zone. **When welding with electrodes which require special ventilation such as stainless or hard facing (see instructions on container or MSDS) or on lead or cadmium plated steel and other metals or coatings which produce highly toxic fumes, keep exposure as low as possible and within applicable OSHA PEL and ACGIH TLV limits using local exhaust or mechanical ventilation. In confined spaces or in some circumstances, outdoors, a respirator may be required. Additional precautions are also required when welding on galvanized steel.**

5. b. The operation of welding fume control equipment is affected by various factors including proper use and positioning of the equipment, maintenance of the equipment and the specific welding procedure and application involved. Worker exposure level should be checked upon installation and periodically thereafter to be certain it is within applicable OSHA PEL and ACGIH TLV limits.

5.c. Do not weld in locations near chlorinated hydrocarbon vapors coming from degreasing, cleaning or spraying operations. The heat and rays of the arc can react with solvent vapors to form phosgene, a highly toxic gas, and other irritating products.

5.d. Shielding gases used for arc welding can displace air and cause injury or death. Always use enough ventilation, especially in confined areas, to insure breathing air is safe.

5.e. Read and understand the manufacturer’s instructions for this equipment and the consumables to be used, including the material safety data sheet (MSDS) and follow your employer’s safety practices. MSDS forms are available from your welding distributor or from the manufacturer.

5.f. Also see item 1.b.

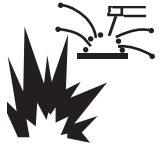

WELDING and CUTTING SPARKS can cause fire or explosion.

6.a. Remove fire hazards from the welding area. If this is not possible, cover them to prevent the welding sparks from starting a fire.

Remember that welding sparks and hot materials from welding can easily go through small cracks and openings to adjacent areas. Avoid welding near hydraulic lines. Have a fire extinguisher readily available.

- 6.b. Where compressed gases are to be used at the job site, special precautions should be used to prevent hazardous situations. Refer to "Safety in Welding and Cutting" (ANSI Standard Z49.1) and the operating information for the equipment being used.
- 6.c. When not welding, make certain no part of the electrode circuit is touching the work or ground. Accidental contact can cause overheating and create a fire hazard.
- 6.d. Do not heat, cut or weld tanks, drums or containers until the proper steps have been taken to insure that such procedures will not cause flammable or toxic vapors from substances inside. They can cause an explosion even though they have been "cleaned". For information, purchase "Recommended Safe Practices for the Preparation for Welding and Cutting of Containers and Piping That Have Held Hazardous Substances", AWS F4.1 from the American Welding Society (see address above).
- 6.e. Vent hollow castings or containers before heating, cutting or welding. They may explode.
- 6.f. Sparks and spatter are thrown from the welding arc. Wear oil free protective garments such as leather gloves, heavy shirt, cuffless trousers, high shoes and a cap over your hair. Wear ear plugs when welding out of position or in confined places. Always wear safety glasses with side shields when in a welding area.
- 6.g. Connect the work cable to the work as close to the welding area as practical. Work cables connected to the building framework or other locations away from the welding area increase the possibility of the welding current passing through lifting chains, crane cables or other alternate circuits. This can create fire hazards or overheat lifting chains or cables until they fail.
- 6.h. Also see item 1.c.
- 6.i. Read and follow NFPA 51B "Standard for Fire Prevention During Welding, Cutting and Other Hot Work", available from NFPA, 1 Batterymarch Park, PO box 9101, Quincy, Ma 022690-9101.
- 6.j. Do not use a welding power source for pipe thawing.

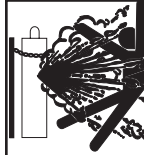

CYLINDER may explode if damaged.

- 7.a. Use only compressed gas cylinders containing the correct shielding gas for the process used and properly operating regulators designed for the gas and pressure used. All hoses, fittings, etc. should be suitable for the application and maintained in good condition.
- 7.b. Always keep cylinders in an upright position securely chained to an undercarriage or fixed support.
- 7.c. Cylinders should be located:
 - Away from areas where they may be struck or subjected to physical damage.
 - A safe distance from arc welding or cutting operations and any other source of heat, sparks, or flame.
- 7.d. Never allow the electrode, electrode holder or any other electrically "hot" parts to touch a cylinder.
- 7.e. Keep your head and face away from the cylinder valve outlet when opening the cylinder valve.
- 7.f. Valve protection caps should always be in place and hand tight except when the cylinder is in use or connected for use.
- 7.g. Read and follow the instructions on compressed gas cylinders, associated equipment, and CGA publication P-1, "Precautions for Safe Handling of Compressed Gases in Cylinders," available from the Compressed Gas Association 1235 Jefferson Davis Highway, Arlington, VA 22202.



FOR ELECTRICALLY powered equipment.

- 8.a. Turn off input power using the disconnect switch at the fuse box before working on the equipment.
- 8.b. Install equipment in accordance with the U.S. National Electrical Code, all local codes and the manufacturer's recommendations.
- 8.c. Ground the equipment in accordance with the U.S. National Electrical Code and the manufacturer's recommendations.

Refer to <http://www.lincolnelectric.com/safety> for additional safety information.

PRÉCAUTIONS DE SÛRETÉ

Pour votre propre protection lire et observer toutes les instructions et les précautions de sûreté spécifiques qui paraissent dans ce manuel aussi bien que les précautions de sûreté générales suivantes:

Sûreté Pour Soudage A L'Arc

1. Protégez-vous contre la secousse électrique:
 - a. Les circuits à l'électrode et à la pièce sont sous tension quand la machine à souder est en marche. Eviter toujours tout contact entre les parties sous tension et la peau nue ou les vêtements mouillés. Porter des gants secs et sans trous pour isoler les mains.
 - b. Faire très attention de bien s'isoler de la masse quand on soude dans des endroits humides, ou sur un plancher métallique ou des grilles métalliques, principalement dans les positions assis ou couché pour lesquelles une grande partie du corps peut être en contact avec la masse.
 - c. Maintenir le porte-électrode, la pince de masse, le câble de soudage et la machine à souder en bon et sûr état de fonctionnement.
 - d. Ne jamais plonger le porte-électrode dans l'eau pour le refroidir.
 - e. Ne jamais toucher simultanément les parties sous tension des porte-électrodes connectés à deux machines à souder parce que la tension entre les deux pinces peut être le total de la tension à vide des deux machines.
 - f. Si on utilise la machine à souder comme une source de courant pour soudage semi-automatique, ces précautions pour le porte-électrode s'appliquent aussi au pistolet de soudage.
2. Dans le cas de travail au dessus du niveau du sol, se protéger contre les chutes dans le cas où on recoit un choc. Ne jamais enrouler le câble-électrode autour de n'importe quelle partie du corps.
3. Un coup d'arc peut être plus sévère qu'un coup de soleil, donc:
 - a. Utiliser un bon masque avec un verre filtrant approprié ainsi qu'un verre blanc afin de se protéger les yeux du rayonnement de l'arc et des projections quand on soude ou quand on regarde l'arc.
 - b. Porter des vêtements convenables afin de protéger la peau de soudeur et des aides contre le rayonnement de l'arc.
 - c. Protéger l'autre personnel travaillant à proximité au soudage à l'aide d'écrans appropriés et non-inflammables.
4. Des gouttes de laitier en fusion sont émises de l'arc de soudage. Se protéger avec des vêtements de protection libres de l'huile, tels que les gants en cuir, chemise épaisse, pantalons sans revers, et chaussures montantes.
5. Toujours porter des lunettes de sécurité dans la zone de soudage. Utiliser des lunettes avec écrans latéraux dans les zones où l'on pique le laitier.
6. Eloigner les matériaux inflammables ou les recouvrir afin de prévenir tout risque d'incendie dû aux étincelles.
7. Quand on ne soude pas, poser la pince à un endroit isolé de la masse. Un court-circuit accidentel peut provoquer un échauffement et un risque d'incendie.
8. S'assurer que la masse est connectée le plus près possible de la zone de travail qu'il est pratique de le faire. Si on place la masse sur la charpente de la construction ou d'autres endroits éloignés de la zone de travail, on augmente le risque de voir passer le courant de soudage par les chaînes de levage, câbles de grue, ou autres circuits. Cela peut provoquer des risques d'incendie ou d'échauffement des chaînes et des câbles jusqu'à ce qu'ils se rompent.
9. Assurer une ventilation suffisante dans la zone de soudage. Ceci est particulièrement important pour le soudage de tôles galvanisées plombées, ou cadmiées ou tout autre métal qui produit des fumées toxiques.
10. Ne pas souder en présence de vapeurs de chlore provenant d'opérations de dégraissage, nettoyage ou pistolage. La chaleur ou les rayons de l'arc peuvent réagir avec les vapeurs du solvant pour produire du phosgène (gas fortement toxique) ou autres produits irritants.
11. Pour obtenir de plus amples renseignements sur la sûreté, voir le code "Code for safety in welding and cutting" CSA Standard W 117.2-1974.

PRÉCAUTIONS DE SÛRETÉ POUR LES MACHINES À SOUDER À TRANSFORMATEUR ET À REDRESSEUR

1. Relier à la terre le châssis du poste conformément au code de l'électricité et aux recommandations du fabricant. Le dispositif de montage ou la pièce à souder doit être branché à une bonne mise à la terre.
2. Autant que possible, l'installation et l'entretien du poste seront effectués par un électricien qualifié.
3. Avant de faire des travaux à l'intérieur de poste, la débrancher à l'interrupteur à la boîte de fusibles.
4. Garder tous les couvercles et dispositifs de sûreté à leur place.

Thank You —

for selecting a **QUALITY** product by Lincoln Electric. We want you to take pride in operating this Lincoln Electric Company product ... as much pride as we have in bringing this product to you!

CUSTOMER ASSISTANCE POLICY

The business of The Lincoln Electric Company is manufacturing and selling high quality welding equipment, consumables, and cutting equipment. Our challenge is to meet the needs of our customers and to exceed their expectations. On occasion, purchasers may ask Lincoln Electric for advice or information about their use of our products. We respond to our customers based on the best information in our possession at that time. Lincoln Electric is not in a position to warrant or guarantee such advice, and assumes no liability, with respect to such information or advice. We expressly disclaim any warranty of any kind, including any warranty of fitness for any customer's particular purpose, with respect to such information or advice. As a matter of practical consideration, we also cannot assume any responsibility for updating or correcting any such information or advice once it has been given, nor does the provision of information or advice create, expand or alter any warranty with respect to the sale of our products.

Lincoln Electric is a responsive manufacturer, but the selection and use of specific products sold by Lincoln Electric is solely within the control of, and remains the sole responsibility of the customer. Many variables beyond the control of Lincoln Electric affect the results obtained in applying these types of fabrication methods and service requirements.

Subject to Change – This information is accurate to the best of our knowledge at the time of printing. Please refer to www.lincolnelectric.com for any updated information.

Please Examine Carton and Equipment For Damage Immediately

When this equipment is shipped, title passes to the purchaser upon receipt by the carrier. Consequently, Claims for material damaged in shipment must be made by the purchaser against the transportation company at the time the shipment is received.

Please record your equipment identification information below for future reference. This information can be found on your machine nameplate.

Product _____

Model Number _____

Code Number or Date Code _____

Serial Number _____

Date Purchased _____

Where Purchased _____

Whenever you request replacement parts or information on this equipment, always supply the information you have recorded above. The code number is especially important when identifying the correct replacement parts.

On-Line Product Registration

- Register your machine with Lincoln Electric either via fax or over the Internet.
- For faxing: Complete the form on the back of the warranty statement included in the literature packet accompanying this machine and fax the form per the instructions printed on it.
- For On-Line Registration: Go to our **WEB SITE at www.lincolnelectric.com**. Choose "Quick Links" and then "Product Registration". Please complete the form and submit your registration.

Read this Operators Manual completely before attempting to use this equipment. Save this manual and keep it handy for quick reference. Pay particular attention to the safety instructions we have provided for your protection. The level of seriousness to be applied to each is explained below:

WARNING

This statement appears where the information **must** be followed **exactly** to avoid **serious personal injury** or **loss of life**.

CAUTION

This statement appears where the information **must** be followed to avoid **minor personal injury** or **damage to this equipment**.

Installation	Section A
Technical Specifications.....	A-1
Safety Precautions.....	A-2
Location and Ventilation.....	A-2
Storing.....	A-2
Stacking.....	A-3
Tilting.....	A-3
Lifting.....	A-3
Pre-Operation Engine Service.....	A-3
Oil.....	A-3
Fuel.....	A-3
Spark Arrester.....	A-3
Electrical and Welding Connections.....	A-4
Machine Grounding.....	A-5
Plugs and Hand-Held Equipment, Auxiliary Power Receptacles.....	A-6
Premises Wiring.....	A-6
Circuit Breakers.....	A-6
Electrical Devices used with the Outback™ 185.....	A-7
<hr/>	
Operation	Section B
Safety Instructions.....	B-1
Symbols.....	B-2
General Description.....	B-3
Recommended Applications.....	B-3
Operational Features and Controls.....	B-3
Design Features and Advantages.....	B-3
Welding Capability.....	B-3
Limitations.....	B-3
Controls and Settings.....	B-4
Welder/Generator Controls.....	B-4
Engine Operation.....	B-5
Welding Operation.....	B-6
Auxiliary Power.....	B-7
Electrode selection Guide.....	B-7
Auxiliary Power Application.....	B-8
<hr/>	
Accessories	Section C
General Options / Accessories.....	C-1
<hr/>	
Maintenance	Section D
Safety Precautions.....	D-1
Routine and Periodic Engine Maintenance.....	D-1, D-2
<hr/>	
Troubleshooting	Section E
How to Use Troubleshooting Guide.....	E-1
Troubleshooting Guide.....	E-2 thru E-4
<hr/>	
Wiring Diagram and Dimension Print	Section F
<hr/>	
Parts List	P-591 Series
<hr/>	

TECHNICAL SPECIFICATIONS - OUTBACK™ 185 (K2706-1)

INPUT - GASOLINE ENGINE					
Make/Model	Description	Speed (RPM)	Displacement	Ignition System	Capacities
KOHLER CS 12.75	1 cylinder 4 cycle air-cooled OHV gasoline 12.75 HP @ 3600 RPM Aluminum Block w/ Cast Iron Sleeve	3750RPM High Idle 1825RPM Low Idle 3400RPM Full Load	21.96 cu. in (360 cc)	Electric & Recoil Start; Manual Choke	Fuel: 6.86 gal. (24.9L) Oil: 1.2 Qts. (1.1L)
			Bore x Stroke 3.35" x 2.48" (85 mm x 63mm)		
RATED OUTPUT - WELDER					
AMPS @ DC CONSTANT CURRENT		DUTY CYCLE		VOLTS @ RATED AMPERES	
100		100%		25	
130		60%		25	
150		20%		25	
185		MAX OUTPUT		---	
OUTPUT -WELDER AND GENERATOR					
Welding Ranges		Welding Open Circuit Voltage		AC Auxiliary Power	
50 - 185 Amps DC		80 VDC Max.		4600 Watts 115V 1PH 100% Duty Cycle 5700 Peak Watts 5200 Continuous Watts 120 / 230 V 1PH	
PHYSICAL DIMENSIONS					
HEIGHT		WIDTH		DEPTH	
25.47 in.		21.12 in.		31.48 in.	
646.94 mm		536.45 mm		799.59 mm	
OPERATING TEMPERATURE RANGE			STORAGE TEMPERATURE RANGE		
0° F TO 104° F (-18° C TO 40° C)			-40° F TO 131° F (-40° C TO 55° C)		

OUTBACK™ 185



SAFETY PRECAUTIONS

Read this entire installation section before you start installation.

WARNING

Do not attempt to use this equipment until you have thoroughly read all operating and maintenance manuals supplied with your machine. They include important safety precautions, detailed engine starting, operating and maintenance instructions, and parts lists.

Hazards of Electric Shock, Engine Exhaust & Moving Parts

WARNING

ELECTRIC SHOCK can kill.



- Do not touch electrically live parts or electrode with skin or wet clothing.
- Insulate yourself from work and ground.
- Always wear dry insulating gloves.



ENGINE EXHAUST can kill.

- Use in open, well ventilated areas or vent exhaust outside.
- Do not stack anything on or near the engine.



MOVING PARTS can injure.

- Do not operate with doors open or guards off.
- Stop engine before servicing.
- Keep away from moving parts.

Only qualified personnel should install, use, or service this equipment.

LOCATION AND VENTILATION

Whenever you use the OUTBACK™ 185, be sure that clean cooling air can flow around the machine's gasoline engine and the generator. Avoid dusty, dirty areas. Also, keep the machine away from heat sources. Do not place the back end of the generator anywhere near hot engine exhaust from another machine. And of course, make sure that engine exhaust is ventilated to an open, outside area.

The OUTBACK™ 185 must be used outdoors. Do not set the machine in puddles or otherwise submerge it in water. Such practices pose safety hazards and cause improper operation and corrosion of parts.

Always operate the OUTBACK™ 185 with the case roof on and all machine components completely assembled. This will help to protect you from the dangers of moving parts, hot metal surfaces, and live electrical devices.

STORING

1. Store the machine in a cool, dry place when it is not in use. Protect it from dust and dirt. Keep it where it can not be accidentally damaged from construction activities, moving vehicles and other hazards.
2. If you will be storing the machine for over 30 days, you should drain the fuel to protect fuel system and carburetor parts from gum deposits. Empty all fuel from the tank and run the engine until it stops from lack of fuel.
3. You can store the machine for up to 24 months if you use a stabilizing Additive in the fuel system. Mix the additive with the fuel in the tank and run the engine for a short time to circulate the additive through the carburetor.
4. While the engine is still warm, drain the oil and refill with fresh 10W30 oil.
5. Remove the spark plug and pour approximately 1/2 ounce (15ml) of engine oil into the cylinder. Replace the spark plug and crank the engine slowly to distribute the oil.
6. Clean any dirt and debris from the cylinder and cylinder head fins and housing, rotating screen, and muffler areas.
7. Store in a clean, dry area.

OUTBACK™ 185



STACKING

OUTBACK™ 185 machines CANNOT be stacked.

TILTING

Place the machine on a secure, level surface whenever you use it or store it. Any surfaces you place it on other than the ground must be firm, non-skid, and structurally sound.

The gasoline engine is designed to run in a level position for best performance. It can operate at an angle, but this should never be more than 15 degrees in any direction. If you do operate it at a slight angle, be sure to check the oil regularly and keep the oil level full. Also, fuel capacity will be a little less at an angle.

LIFTING

The OUTBACK™ 185 should be lifted by two people. (See Specification section for weight). The LowLift™ grab bars on both ends make lifting easier.

PRE-OPERATION ENGINE SERVICE

Read and understand the engine operating and maintenance instructions supplied with this machine before you operate the OUTBACK™ 185.

WARNING

- Keep hands away from muffler or HOT engine parts.
- Stop the engine when fueling.
- Do not smoke when fueling.
- Remove fuel cap slowly to release pressure.
- Do not overfill tank.
- Wipe up spilled fuel and allow fumes to clear before starting engine.
- Keep sparks and flame away from tank.

OIL

The OUTBACK™ 185 is shipped with the engine filled with SAE 10W30 oil. **CHECK THE OIL LEVEL BEFORE YOU START THE ENGINE.** This is an added precaution. Do not screw in dipstick when checking oil level. **DO NOT OVERFILL.** Be sure the fill plug is tight after servicing.

FUEL





Fill the fuel tank with clean, fresh, regular grade (minimum 87 octane lead free gasoline. **DO NOT MIX OIL WITH GAS.** The OUTBACK™ 185 capacity is approximately 6.8 gallons (25.74 Liter). **DO NOT OVER-FILL,** allow room in the fuel tank for fuel expansion.

SPARK ARRESTER

Some federal, state or local laws may require gasoline engines to be equipped with exhaust spark arresters when they are operated in certain locations where unarrested sparks may present a fire hazard. The standard muffler included with this machine does not qualify as a spark arrester. For areas requiring spark arrestors, use K2793-1.

CAUTION

An incorrect additional arrester may lead to damage to the engine or adversely affect performance.

 WARNING		GASOLINE FUEL ONLY			
	<ul style="list-style-type: none"> • Stop engine when fueling. • Do not smoke when fueling. • Keep sparks and flame away from tank. • Do not leave unattended while fueling. • Wipe up spilled fuel and allow fumes to clear before starting engine. • Do not overfill tank, fuel expansion may cause overflow. • Close fuel shut off valve when transporting or not operating machine. 		<ul style="list-style-type: none"> • Use in open, well ventilated area or vent exhaust outside. 		
GASOLINE can cause fire or explosion		ENGINE EXHAUST can kill	<td></td> <td> <ul style="list-style-type: none"> • Keep away from moving parts. • Do not operate with panels open or guards off. </td>		<ul style="list-style-type: none"> • Keep away from moving parts. • Do not operate with panels open or guards off.
			MOVING PARTS can injure	S19799 VM	

OUTBACK™ 185



OUTBACK™ 185 OUTPUT CONNECTIONS

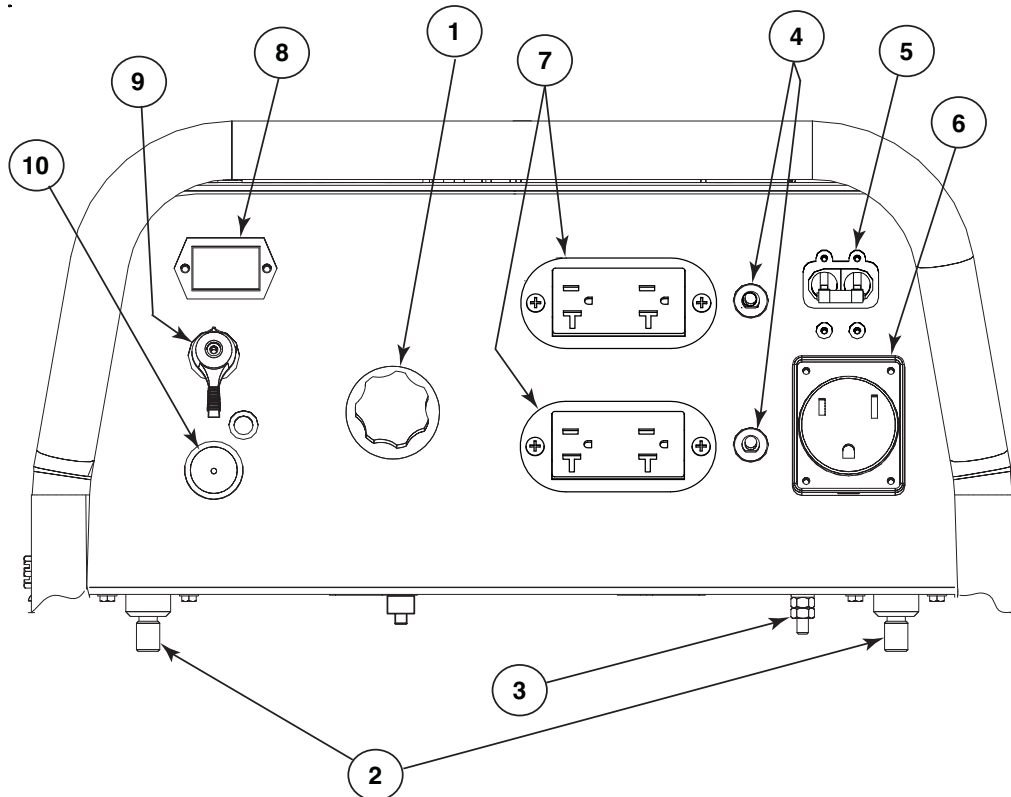

FIGURE A.1

- | | |
|----------------------------------|--|
| 1. CURRENT CONTROL DIAL | 7. DUPLEX RECEPTACLE (2)- 120 VOLT, 20 AMP |
| 2. WELD OUTPUT TERMINALS (2) | 8. HOURMETER |
| 3. GROUND STUD | 9. ENGINE SWITCH |
| 4. CIRCUIT BREAKERS (2) - 20 AMP | 10. CHOKE |
| 5. CIRCUIT BREAKER 30 Amp | |
| 6. RECEPTACLE - 240 VOLT, 50 AMP | |

ELECTRICAL OUTPUT CONNECTIONS

See Figure A.1 for the location of the current control dial, weld output terminals, ground stud, circuit breakers, 240 and 120 volt receptacles.

WELDING CABLE CONNECTIONS

Cable Size and Length

Be sure to use welding cables that are large enough. The correct size and length becomes especially important when you are welding at a distance from the welder.

Table A.1 lists recommended cable sizes and lengths for rated current and duty cycle. Length refers to the distance from the welder to the work and back to the welder. Cable diameters are increased for long cable lengths to reduce voltage drops.

TABLE A.1
RECOMMENDED WELDING CABLE
SIZE AND LENGTH

TOTAL COMBINED LENGTH OF ELECTRODE AND WORK CABLES	
Cable Length	125 Amps 30% Duty Cycle
0-50 ft (0-15m)	6 AWG
50-100 ft (15-30 m)	5 AWG
100-150 ft (30-46 m)	3 AWG
150-200 ft (46-61 m)	2 AWG
200-250 ft (61-76m)	1 AWG

OUTBACK™ 185



Cable Installation

Install the welding cables to your OUTBACK™ 185 as follows. See Figure A.1 for the location of parts.

1. The gasoline engine must be OFF to install welding cables.
2. Remove the 1/2-13 flanged nuts from the output terminals.
3. Connect the electrode holder and work cables to the weld output terminals. Normally, the electrode cable is connected to the positive (+) output stud.
4. Tighten the flanged nuts securely.
5. Be certain that the metal piece you are welding (the “work”) is securely connected to the work clamp and cable.
6. Check and tighten the connections periodically.

CAUTION

- Loose connections will cause the output studs to overheat and the studs may eventually melt.
- Do not cross welding cables at output stud connection. Keep isolated and separate from one another.

Lincoln Electric offers a welding accessory kit with #6 welding cables. See the **ACCESSORIES** section of this manual for more information.

For more information on welding , see **WELDING OPERATION** in the **OPERATION** section of this manual.

MACHINE GROUNDING

Because this portable engine driven welder or generator creates its own power, it is not necessary to connect its frame to an earth ground, unless the machine is connected to premises wiring (your home, shop, etc.).

To prevent dangerous electric shock, other equipment to which this engine driven welder supplies power, must:

- a) be grounded to the frame of the welder using a grounded type plug
or
- b) be double insulated

When this welder is mounted on a truck or trailer, the machine grounding  stud must be securely connected to the metal frame of the vehicle.

In general if the machine is to be grounded, it should be connected with a #8 or larger copper wire to a solid earth ground such as a metal water pipe going into the ground for at least ten feet and having no insulated joints, or to the metal framework of a building which has been effectively grounded. The U.S. National Electrical Code lists a number of alternate means of grounding electrical equipment. A machine grounding stud marked with the symbol  is provided on the front of the welder.

WARNING

DO NOT GROUND MACHINE TO A PIPE WHICH CARRIES EXPLOSIVE OR COMBUSTIBLE MATERIAL.

PLUGS AND HAND HELD EQUIPMENT

For further protection against electric shock, any electrical equipment connected to the generator receptacles must use a three-blade, grounded type plug or an Underwriter's Laboratories (UL) approved double insulated tool with a two blade plug.

 **WARNING**

Never operate this machine with damaged or defective cords. All electrical equipment must be in safe operating condition.

AUXILIARY POWER RECEPTACLES

The control panel of the OUTBACK™ 185 features three auxiliary power receptacles:

- Two 20 amp, 120 volt duplex (double outlet) receptacle.
- A 50 amp, 240 volt single outlet receptacle.

See Figure A.1

Through these receptacles the machine can supply up to 5700 watts surge or 5200 watts continuous of single-phase 60 Hertz AC power. The machine output voltages meet UL standards and fall within $\pm 10\%$ of the rated voltage.

PREMISES WIRING

The OUTBACK™ 185 is not recommended for premises wiring. The OUTBACK™ 185 does not have a combined 120/240 volt receptacle and cannot be connected to a premises as described in other Lincoln literature.

The OUTBACK™ 185 is intended only for backup, intermittent use power. Certain electrical devices cannot be powered by the OUTBACK™ 185. Refer to Table A.2 for these devices.

CIRCUIT BREAKERS

Auxiliary power is protected by circuit breakers. When the machine is operated in high temperature environments, the breakers may tend to trip at lower loads than normally.

 **CAUTION**

NEVER BYPASS THE CIRCUIT BREAKERS. WITHOUT OVERLOAD PROTECTION, THE UNIT COULD OVERHEAT AND/OR CAUSE DAMAGE TO THE EQUIPMENT BEING USED.

 **CAUTION**

Certain Electrical devices cannot be powered by the OUTBACK™ 185. See Table A.2

TABLE A.2
ELECTRICAL DEVICE USE WITH THE OUTBACK™ 185

Type	Common Electrical Devices	Possible Concerns
Resistive	Heaters, toasters, incandescent light bulbs, electric range, hot pan, skillet, coffee maker.	NONE
Capacitive	TV sets, radios, microwaves, appliances with electrical control.	Voltage spikes or high voltage regulation can cause the capacitive elements to fail. Surge protection, transient protection, and additional loading is recommended for 100% fail-safe operation. DO NOT RUN THESE DEVICES WITHOUT ADDITIONAL RESISTIVE TYPE LOADS.
Inductive	Single-phase induction motors, drills, well pumps, grinders, small refrigerators, weed and hedge trimmers.	These devices require large current inrush for starting. (See Table B.3, GENERATOR POWER APPLICATIONS, in the OPERATION section of this manual for required starting wattages.) Some synchronous motors may be frequency sensitive to attain maximum output torque, but they SHOULD BE SAFE from any frequency induced failures.
Capacitive / Inductive	Computers, high resolution TV sets, complicated electrical equipment.	An inductive type line conditioner along with transient and surge protection is required, and liabilities still exist. DO NOT USE THESE DEVICES WITH A OUTBACK™ 185.

The Lincoln Electric Company is not responsible for any damage to electrical components improperly connected to a OUTBACK™ 185.

OUTBACK™ 185



SAFETY INSTRUCTIONS

⚠ WARNING

ELECTRIC SHOCK
can kill.

- Do not touch electrically live parts or electrode with skin or wet clothing.
- Insulate yourself from work and ground.
- Always wear dry insulating gloves.



FUMES AND GASES
can be dangerous.

- Keep your head out of fumes.
- Use ventilation or exhaust to remove fumes from breathing zone.



WELDING SPARKS
can cause fire or explosion

- Keep flammable material away.
- Do not weld on containers that have held combustibles.



ARC RAYS
can burn.

- Wear eye, ear and body protection.

⚠ WARNING

ENGINE EXHAUST can kill.

- Use in open, well ventilated areas or vent exhaust outside.
- Do not stack anything on or near the engine.



MOVING PARTS can injure.

- Do not operate with doors open or guards off.
- Stop engine before servicing.
- Keep away from moving parts.

Only qualified personnel should install, use, or service this equipment.

Observe additional Safety Guidelines detailed throughout this manual.

GRAPHIC SYMBOLS USED ON THIS EQUIPMENT OR IN THIS MANUAL



**WARNING /
CAUTION**

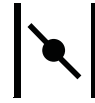

CHOKE



OIL



AIR CLEANER



FUEL



**CIRCUIT
BREAKER**

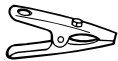

WORK CLAMP



**GROUND
(AUXILIARY
POWER)**



FAST



**ELECTRODE
WELDING ARC**



SLOW



ENGINE OFF



AUTO IDLE



ENGINE START

GENERAL DESCRIPTION

The OUTBACK™ 185 is designed for commercial use welder/generator applications. As a welder it provides 185 amps of DC constant current for welding with DC stick electrodes. A single dial lets you select a full range of welding output from 50 to 185 amps.

As a generator it can supply up to 5700 surge watts or 5200 continuous watts of 120 / 240 volt, single-phase AC power. The machine is portable.

A Kohler CS 12.75 HP air cooled, OHV gasoline engine powers the welder / generator. It has an engine warranty of 3 years.

RECOMMENDED APPLICATIONS

Welder

The OUTBACK™ 185 provides excellent constant current DC welding output for stick (SMAW) welding.

Generator

The OUTBACK™ 185 gives smooth AC generator output for continuous auxiliary power usage within the engine manufacturer's required maintenance recommendations.

OPERATIONAL FEATURES AND CONTROLS

The OUTBACK™ 185 was designed for simplicity. Therefore, it has very few operating controls. A single dial on the control panel lets you select either welder or generator use. For welding, the same dial selects continuous current output over the machine's 50 to 185 amp range.

The gasoline engine controls include a recoil starter, choke and stop switch. See ENGINE OPERATION in the OPERATION section of this manual for details about starting, running, stopping, and breaking in the gasoline engine.

DESIGN FEATURES AND ADVANTAGES

- 185 amp DC constant current welding for stick electrodes.
- Lightweight / portable.
- Full range, continuous welding output control with a single knob.
- Automatic shutdown under low oil level condition.
- Hour Meter Standard.
- 5700 Surge watts or 5200 Watts of continuous 120 / 240 volt single phase AC auxiliary power.
- Kohler CS 12.75 HP overhead cam air-cooled gasoline engine. Smooth running, long life.

WELDING CAPABILITY

The OUTBACK™ 185 rated 185 amps, 20 VDC at 10% duty cycle on a ten-minute basis. This means that you can load the welder to 185 amps for one minute out of every ten-minute period. The machine is capable of higher duty cycles at lower output currents. For example, you can load the welder to 120 amps for ten minutes out of ten for a 100% duty cycle.

The current is continuously variable from 50 to 185 amps DC. The OUTBACK™ 185 can, therefore, weld with all 3/32", 1/8" and most 5/32" diameter Lincoln DC electrodes.

LIMITATIONS

- The OUTBACK™ 185 is not recommended for any processes besides those that are normally performed using stick welding (SMAW) procedures.
- The OUTBACK™ 185 is not recommended for pipe thawing.
- During welding, generator power is limited to 100 watts, and output voltages can drop from 120 to 80 volts and 240 to 160 volts. Therefore, DO NOT OPERATE ANY SENSITIVE ELECTRICAL EQUIPMENT WHILE YOU ARE WELDING.

OUTBACK™ 185



CONTROLS AND SETTINGS All welder/generator controls are located on the Output Control Panel. Gasoline engine controls are mounted on the engine. See Figure B.1 and the figures in engine operation section.

OUTPUT PANEL CONTROLS

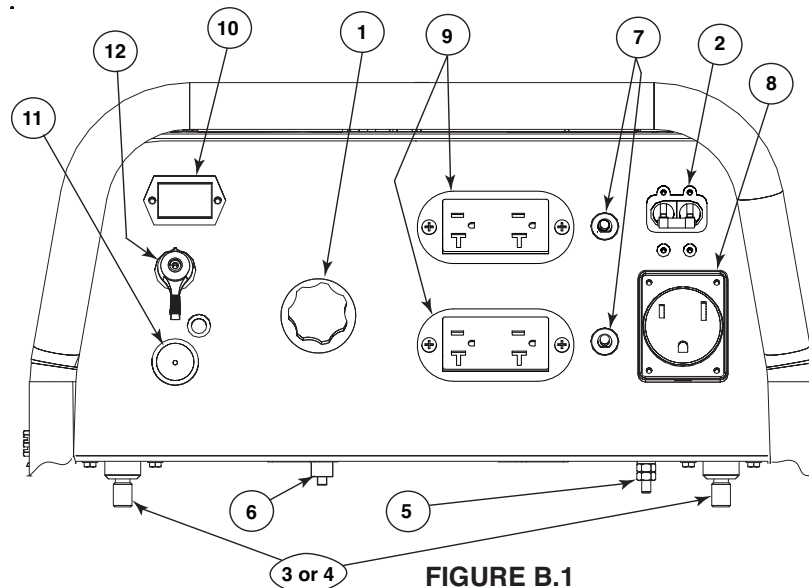





FIGURE B.1

WELDER/GENERATOR CONTROLS

See Figure B.1 for the location of the following features:

1. **CURRENT CONTROL DIAL:** Adjusts continuous current output. The amperages on the dial correspond to the approximate amperages needed for specific Lincoln welding electrodes.
2. **30 AMP CIRCUIT BREAKER:** Provide separate overload current protection for the 120 Volt and 240 Volt Receptacles
3. **WELD POSITIVE OUTPUT TERMINAL:** Provides the connection point for either the electrode holder or the work cable. (Because the OUTBACK™ 185 is a DC output machine, either output terminal can be used for either cable.)
4. **WELD NEGATIVE OUTPUT TERMINAL:** Provides the connection point for either the electrode holder or the work cable. (Because the OUTBACK™ 185 is a DC output machine, either output terminal can be used for either cable.)
5. **GROUND STUD:** Provides a connection point for connecting the machine case to earth ground for the safest grounding procedure.
6. **CIRCUIT BREAKER:** Provides overload protection for weld output terminals.
7. **CIRCUIT BREAKERS (2):** Provide separate overload current protection for the 120 volt and 240 volt receptacles
8. **240 VOLT RECEPTACLE:** Connection point for supplying 250 volt power to operate one electrical device.
9. **120 VOLT DUPLEX RECEPTACLES (2):** Connection point for supplying 120 volt power to operate devices needed for maintenance purposes.
10. **HOUR METER:** Records the time that the engine has run for maintenance purposes.
11. **ENGINE CHOKE:** Engine starting aid.
12. **ENGINE SWITCH:**
Used to start the engine, Select High Idle or Auto Idle while the engine is running and stops the engine.
When placed in the “OFF”  position, the ignition circuit is de-energized to shut down the engine.

When held in the “START”  position, the engine starter motor is energized.

When in “HIGH IDLE” () position, the engine will run continuously at high idle.

When in “AUTO IDLE” () position, the engine will run continuously and the idler operates as follows:
 - **Welding**
When the electrode touches the work, the welding arc is initiated and the engine accelerates to full speed. After welding ceases (and no auxiliary power is being drawn), the engine will return to low idle after approximately 10 to 14 seconds.
 - **Auxiliary Power**
With the engine running at low idle and auxiliary power for lights or tools is drawn (approximately 0-150 watts or greater) from the receptacles, the engine will accelerate to high speed. If no power is being drawn from the receptacles (and not welding) for 10-14 seconds, the idler reduces the engine speed to low idle.

OUTBACK™ 185





ENGINE OPERATION

Starting/Shutdown Instructions

Be sure all Pre-Operation Engine Service has been performed. Also, Read owners manual before starting for the first time. (See INSTALLATION section)

Remove all loads connected to the AC power receptacles. Before starting, first open the fuel shutoff valve.

Always pull the choke control out when starting the engine; cold, warm or hot.

Turn the engine switch to the “**Start**”  position and crank the engine until it starts, slowly return the choke control to the full “in” position (choke open), and turn the switch to the **Auto Idle** ( / ) position. Do not turn the switch to the “start” position while the engine is running because this will cause damage to the ring gear and/or starter motor.

Stopping the Engine

Remove all welding and auxiliary power loads and allow engine to run for a few minutes to cool the engine.

Stop the engine by placing the engine switch in the “Off” () position.

⚠ WARNING

Close the fuel valve when the machine is transported to prevent fuel leakage from the carburetor.

Break-in Period

It is normal for any engine to use larger quantities of oil until break-in is accomplished. Check the oil level twice a day during the break-in period (about 50 running hours). Change the oil after the first 5 hours of operation. See the Engine Instruction Manual for further details.

⚠ CAUTION

IN ORDER TO ACCOMPLISH THIS BREAK-IN, THE UNIT SHOULD BE SUBJECTED TO MODERATE LOADS, WITHIN THE RATING OF THE MACHINE. AVOID LONG IDLE RUNNING PERIODS. REMOVE LOADS AND ALLOW ENGINE TO COOL SEVERAL MINUTES AT LOW IDLE BEFORE SHUTDOWN.

Low Oil Sensing

This engine has a built in sensor which responds to low oil level (not pressure). When activated, the system will shut the engine down. The engine will not restart until sufficient oil is added. Check oil level frequently and add oil as required to the full mark on the dipstick. DO NOT OVERFILL.

Typical Fuel Consumption

	KOHLER CS 12.75 HP
NO LOAD. 2250 R.P.M	.20 GALLONS/HOUR .75 (LITERS/HOUR)
NO LOAD 3750 R.P.M.	.40 GALLONS/HOUR 1.51 (LITERS/HOUR)
DC CC WELD OUTPUT 100 AMPS, 25 VOLTS	.73 GALLONS/HOUR 2.77 (LITERS/HOUR)
AUXILIARY POWER 5200 KVA	.99 GALLONS/HOUR 3.74 (LITERS/HOUR)

WELDING OPERATION

⚠ WARNING

ELECTRIC SHOCK can kill.



- Do not touch electrically live parts or electrode with skin or wet clothing.
- Insulate yourself from work and ground.
- Always wear dry insulating gloves.

ENGINE EXHAUST can kill.



- Use in open, well ventilated areas or vent exhaust outside.
- Do not stack anything on or near the engine.

MOVING PARTS can injure.



- Do not operate with doors open or guards off.
- Stop engine before servicing.
- Keep away from moving parts.

Only qualified personnel should install, use, or service this equipment.

The OUTBACK™ 185 can deliver from 50 to 185 amps of welding output current . Output can be adjusted by setting the current control dial on the output control panel.

You can get maximum welding output by setting the dial to 185 AMPS. At high current settings like this, some output may decrease as the machine is used. If you are welding for a long time, you may need to turn the dial slightly upward to maintain the same results.

The numbers on the dial correspond to the approximate amps needed to weld using specific Lincoln welding rods. Table B.2, WELDING APPLICATIONS, give you the recommended dial settings based on the thickness of the work and the size and type of rod you're using.

TO USE THE OUTBACK 185 FOR WELDING:

1. Remove the flange nuts from the weld output terminals and place the work and electrode welding cables over the terminals. See Figure B.1 and B.1a. Replace and tighten the flange nuts securely. Be sure the connections are tight.
2. Select the appropriate electrode. See Table B.2
3. Attach the work clamp securely to the work you are welding.

4. Insert the electrode into the electrode holder.
5. Set the current control dial to the desired output current .
6. Start the gasoline engine.
See **ENGINE OPERATION** in this section of the manual.
7. Strike an arc and begin welding.

AFTER YOU FINISH THE WELD:

1. Stop the gasoline engine. See **ENGINE OPERATION** in this section of the manual.
2. Allow the electrode and work to cool completely.
3. Remove the work clamp from the work.
4. Remove any remaining piece of electrode from the electrode holder.
5. If you are finished using the OUTBACK 185 for welding, disconnect the welding cables from the weld output terminals. Reattach the flange nuts and leave them on the terminals.

For DC+ welding, the electrode cable is to be connected to the "+" output stud and work cable to the "-" output stud. (For DC- welding, reverse these connections.)

Semi-automatic Wire Welding with a Lincoln Wire Feeder/Welder

The OUTBACK™ 185 generator power can be used to supply up to 5,200 watts continuous input power to a Lincoln Wire Feeder/Welder. The Wire Feeder/ Welder is equipped with all the supplies needed for Flux-Cored Arc Welding (FCAW). Also some Wire Feeder/Welders come equipped with the essentials needed for Gas Metal Arc Welding (GMAW) or MIG processes, while others require the purchase of a conversion kit. These products are available where Lincoln products are sold. Contact your local authorized Lincoln representative for more details.

Plasma Cutting with Lincoln Pro-Cut 25.

The OUTBACK™ 185 generator power can be used to supply up to 5,200 watts continuous input power to a Pro-Cut 25. The Pro-Cut will work satisfactorily under the following conditions:

1. Set the Current Control on the OUTBACK™ 185 to the 185 amp position. (Higher Settings may result in a shutdown of the Pro-Cut 25.)
2. Leave the "ON/OFF" switch on the Pro-Cut "OFF" until the OUTBACK 185 has been started and is at full operating speed.

OUTBACK™ 185



120V Receptacle Operation:

- Set the Output Control on the Pro-Cut 25 no higher than the 15 amp position. (Higher settings may cause circuit breaker on the OUTBACK™ 185 to trip.)
- Maximum material thickness that can be cut is 1/4".

240V Receptacle Operation:

- The Pro-Cut 25 may be used for its full range of control.
- Maximum material thickness that can be cut is 3/8".

AUXILIARY POWER OPERATION**⚠ WARNING**

Be sure that any electrical equipment plugged into the generator AC power receptacles can withstand a $\pm 10\%$ voltage and a $\pm 5\%$ frequency variation. Some electronic devices cannot be powered by the OUTBACK 185. Refer to Table A.2, ELECTRICAL DEVICE USE WITH THE OUTBACK™ 185, in the INSTALLATION section of this manual.

GENERAL INFORMATION

The OUTBACK™ 185 is rated at 5700 Peak watts or 5200 continuous watts. It provides both 120 volt and 240 volt power. You can draw up to 20 amps from either side of the 120 volt duplex receptacle, but not more than 35.4 amps from both sides at once. Up to 17.7 amps can be drawn from the single 240 volt receptacle.

Electrical loads in watts are calculated by multiplying the voltage rating of the load by the number of amps it draws. (This information is given on the load device nameplate.) For example, a device rated 120 volts, 2 amps will need 240 watts of power ($120 \times 2 = 240$).

You can use Table B.3, AUXILIARY POWER APPLICATIONS, to determine the wattage requirements of the most common types of loads you can power with the OUTBACK™ 185. Be sure to read the notes at the bottom of the table.

TO USE THE OUTBACK 185 AS AN AUXILIARY POWER SUPPLY:

1. Start the gasoline engine. See **ENGINE OPERATION** in this section of the manual.
2. Set the current control dial on the output control panel to "MAX." See Figure B.1.
3. Plug the load(s) into the appropriate 120 volt or 240 volt power receptacle.

NOTE: During welding, the maximum generator output for auxiliary loads is 100 watts.

NOTE: You can supply multiple loads as long as the total load does not exceed 5700 Peak watts or 5200 continuous watts. Be sure to start the largest loads first.

**TABLE B.2
ELECTRODE SELECTION GUIDE**

AWS CLASSIFICATION	ELECTRODE TYPE	ELECTRODE POLARITY	CURRENT RANGE (AMPS)		
			● 3/32 SIZE	● 1/8 SIZE	● 5/32 SIZE
E6010	FLEETWELD® 5P	DC+	50-75	75-135	90-175
E6011	FLEETWELD® 35	DC+	50-75	70-110	80-145
E6011	FLEETWELD® 180	DC+	50-80	55-110	105-135
E6013	FLEETWELD® 37	DC±	70-95	100-135	145-180
E7018	EXCALIBUR® 7018	DC+	70-100	90-125	125-185
E7018	JETWELD® LH-73	DC+	65-85	90-125	130-185
E708-17 & E308L-17	BLUE MAX® 308/308L AC-DC	DC+	50-80	75-110	95-150
ENi-CI	SOFTWELD® 99Ni	DC+	50-80	80-110	100-140
-	WEARSHIELD® ABR	DC+	-	50-150	50-185
SHEET THICKNESS			1/8 AND THINNER	1/8 AND THICKER	

OUTBACK™ 185



**TABLE B.3
AUXILIARY POWER APPLICATIONS**

Suggested Power Applications	Running Watts (Continuous)	*Start-up Watts (Peak)
*Air Compressor - 1 HP	2,000	4,000 - 8,000
*Air Compressor - 3/4 HP	1,250	3,100 - 5,000
*Airless Sprayer - 1/3 HP	600	1,500 - 2,400
Chain Saw	1,200	
Circular Saw	1,200	
Coffee Maker	1,000	
*Deep Freezer	500	750 - 2,000
*Electric Motor - 1 HP	1,000	2,500 - 4,000
Electric Range (1 element)	1,500	
Electric Skillet	1,250	
*Furnace Fan - 1/3 HP	1,200	3,000 - 4,800
Portable Grinder (4 1/2")	600	
Portable Grinder (7")	2,000	
Halogen Work Light	500	
Hand Drill - 1/4"	500	
Hand Drill - 3/8"	700	
1500 Watt Heater	1,750	
Hedge Trimmer	450	
Light Bulb	100	
Reciprocating Saw	900	
Radial Arm Saw	2,600	
Radio	50	
*Refrigerator/Freezer (small)	600	1,500 - 2,400
Slow Cooker	200	
*Submersible Pump - 1 HP	1,000	2,500 - 4,000
*Sump Pump	600	1,500 - 2,400
Toaster	1,100	
Weed Trimmer	500	
Lincoln Wire Feeder/Welder	4,000	

NOTES:

Wattages listed are approximate. Check your equipment for actual wattage.

Equipment with unusually high *START-UP WATTS are listed. For start-up of other equipment that uses a motor, listed in the table, multiply RUNNING WATTS by 2.

Multiple loads can be used as long as the total load does not exceed 5,700 Peak watts. Be sure to start the largest loads first.

OPTIONS/ACCESSORIES

The following options/accessories are available for your OUTBACK™ 185 from your local Lincoln Distributor:

Accessory Kit (K875) – Includes the following:

- Twenty feet (6.1 meters) of #6 AWG electrode cable with lug.
- Fifteen feet (4.6 meters) of #6 work cable with lugs.
- Work Clamp
- Headshield with No. 10 filter
- Insulated electrode holder and sample electrodes 150 amp capacity.

Undercarriage (K2722-1) - A two-wheeled, hand movable undercarriage is available for field installation.

Rotor Removal Kit (S20925) - A service kit with thru bolt and impact bolt's for removing the generator rotor from tapered engine crank shaft.

Spark Arrestor Kit (K2793-1) - Attaches to muffler exhaust tube. Virtually eliminates spark emissions.

Canvas Covers (K2804-1) - To protect the Outback 185 when not in use. Made from attractive red canvas which is flame retardant, mildew resistant and water repellent.

SAFETY PRECAUTIONS

⚠ WARNING

- Have qualified personnel do all maintenance and troubleshooting work.
- Turn the engine off before working inside the machine.
- Remove guards only when necessary to perform maintenance and replace them when the maintenance requiring their removal is complete.
- If guards are missing from the machine, get replacements from a Lincoln Distributor. See the EXPLODED VIEW AND PARTS LIST at the back of this manual.

Read the Safety Precautions in the front of this manual and in the Kohler **Operating and Maintenance Instructions** manual before working on the OUTBACK™ 185. Keep all equipment safety guards, covers, and devices in position and in good repair. Keep your hands, hair, clothing, and tools away from the recoil housing, fans, and all other moving parts when starting, operating, or repairing this machine.

ROUTINE AND PERIODIC MAINTENANCE

ENGINE MAINTENANCE

⚠ CAUTION

To prevent the engine from accidentally starting, disconnect the spark plug lead before servicing the engine.

See the Kohler Owner's manual for a summary of maintenance intervals for the engine. Follow either the hourly or the calendar intervals, whichever come first. More frequent service may be required, depending on your specific application and operating conditions. The Kohler Owner's manual shows engine maintenance replacement parts and numbers.



OIL: Check the oil level after every 5 hours of operation or daily. **BE SURE TO MAINTAIN THE OIL LEVEL.**

Change the oil the first time after 20 hours of operation. Then, under normal operating conditions, change the oil after every 100 hours or once a year, whichever occurs first. If the engine is operated under heavy load or in high ambient temperatures, change the oil every 50 hours.

Drain the oil from the drain plug located on either side of the engine bottom, as shown in **Figure D.1**. Refill through the oil fill plug until the oil reaches the full mark on the dip stick. See Engine Owner's manual for specific oil recommendations.

FIGURE D.1 - OIL DRAIN AND REFILL LOCATION

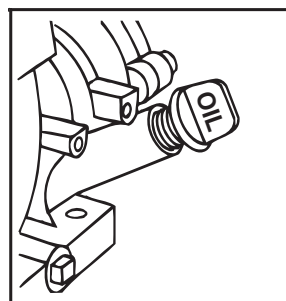

Do not screw in dipstick to check oil

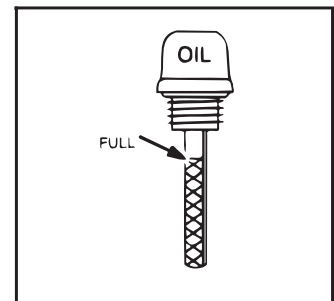

FILL to FULL mark on dipstick - recheck

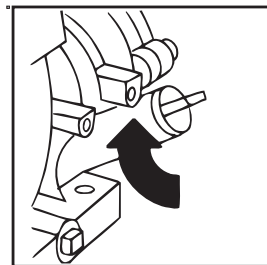

Tighten dipstick firmly before starting

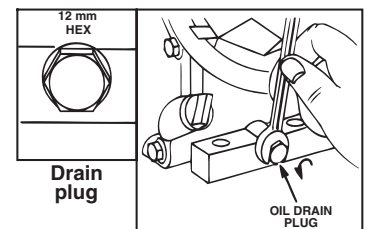

Oil drain



FUEL: At the end of each day's use, refill the fuel tank to minimize moisture condensation and dirt contamination in the fuel line.



AIR CLEANER: With normal operating conditions, the maintenance schedule for cleaning and re-oiling the foam pre-filter is every 50 hours and replacement of the air cleaner filter element every 100 hours. More frequent servicing is required with dusty operating conditions. Refer to the maintenance section of the Engine Owner's Manual for more information.

To service the pre-cleaner:

Remove the cover. Carefully remove the foam pre-cleaner from the filter element.

1. Wash in liquid detergent and water.
2. Squeeze dry in a clean cloth.
3. Saturate in clean engine oil.
4. Squeeze in a clean, absorbent cloth to remove all excess oil.

Carefully place the pre-cleaner back over the filter element and reinstall the air cleaner cover and wing nuts.

CLEAN ENGINE: Remove dirt and debris with a cloth or a brush. Do not clean with a forceful spray of water. Water might contaminate the fuel system. Use low pressure air to blow out the machine periodically. In particularly dirty locations this may be required once a week.

SPARK PLUG SERVICE

To service spark plug, remove the 9 screws securing the side panel. Remove side panel and place provided fiber spacer between the muffler and bottom of control panel. See Figure D.2.

FIGURE D.2

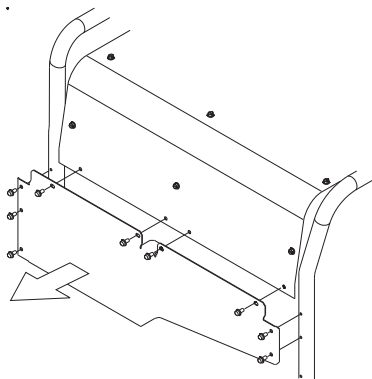
**ENGINE ADJUSTMENTS**

OVERSPEED IS HAZARDOUS - The maximum

⚠ WARNING

allowable high idle speed for this machine is 3750 RPM, no load. Do NOT tamper with the governor components or setting or make any other adjustments to increase the maximum speed. Severe personal injury and damage to the machine can result if operated at speeds above maximum.

Adjustments to the engine are to be made only by a Lincoln Service Center or an authorize Field Service Shop.

SLIP RINGS**⚠ CAUTION**

A slight amount of darkening and wear of the slip rings and brushes is normal. Brushes should be inspected when a general overhaul is necessary. If brushes are to be replace, clean slip rings with a fine emery paper.

Do not attempt to polish slip rings while engine is running.

HARDWARE

Both English and Metric fasteners are used in this welder.

ENGINE MAINTENANCE PARTS**Kohler CS 12.75**

Air Filter Element	63 083 19-S
Air Filter Pre-Cleaner	63 083 17-S
Spark Plug	Champion RC 12YC
(Resistor Type)	(Gap .030" [.76mm])

OPERATIONAL CLEARANCE**⚠ CAUTION**

Approximately 12-18" of clearance should be around this unit during operation for air flow. Reducing this clearance will reduce air flow to the machine causing operational temperatures to increase. Possible damage to the machine can result if to much air flow is restricted.

HOW TO USE TROUBLESHOOTING GUIDE

WARNING

Service and Repair should only be performed by Lincoln Electric Factory Trained Personnel. Unauthorized repairs performed on this equipment may result in danger to the technician and machine operator and will invalidate your factory warranty. For your safety and to avoid Electrical Shock, please observe all safety notes and precautions detailed throughout this manual.

This Troubleshooting Guide is provided to help you locate and repair possible machine malfunctions. Simply follow the three-step procedure listed below.

Step 1. LOCATE PROBLEM (SYMPTOM).

Look under the column labeled "PROBLEM (SYMPTOMS)". This column describes possible symptoms that the machine may exhibit. Find the listing that best describes the symptom that the machine is exhibiting.

Step 2. POSSIBLE CAUSE.

The second column labeled "POSSIBLE CAUSE" lists the obvious external possibilities that may contribute to the machine symptom.

Step 3. RECOMMENDED COURSE OF ACTION

This column provides a course of action for the Possible Cause, generally it states to contact your local Lincoln Authorized Field Service Facility.

If you do not understand or are unable to perform the Recommended Course of Action safely, contact your local Lincoln Authorized Field Service Facility.

CAUTION

If for any reason you do not understand the test procedures or are unable to perform the tests/repairs safely, contact your **Local Lincoln Authorized Field Service Facility** for technical troubleshooting assistance before you proceed.

Observe all Safety Guidelines detailed throughout this manual

PROBLEMS (SYMPTOMS)	POSSIBLE CAUSE	RECOMMENDED COURSE OF ACTION
OUTPUT PROBLEMS		
Major Physical or Electrical Damage is Evident.	1. Contact your local Lincoln Authorized Field Service Facility.	If all recommended possible areas of misadjustment have been checked and the problem persists, Contact your local Lincoln Authorized Field Service Facility.
No Generator power or welding output	<ol style="list-style-type: none"> 1. Check brushes for wear. See Maintenance section. 2. Check for loose or faulty connections at brush holders. 3. Open lead in flashing or field circuit. 4. Rheostat (R1) lead broke. 5. Dirty slip rings. 6. Faulty rheostat (R1). 7. Faulty field bridge rectifier (D1). 8. Faulty field capacitor (C1). 9. Faulty stator field winding. 10. Faulty rotor. 	
Generator power is available but unit will not weld.	<ol style="list-style-type: none"> 1. Loose connector to output stud. 2. Work not connected. 3. Electrode holder loose. 4. No open circuit voltage at output studs. Open lead in weld circuit. 5. Faulty output bridge rectifier. 6. Faulty choke (L1). 	
Unit will weld but low or no generator power is available.	<ol style="list-style-type: none"> 1. Circuit breaker is open. 2. Loose or open connection with electrical plug-in component. 3. Current control dial not at "MAX" 4. No open circuit voltage at receptacle. 	
No auxillary power but machine has weld output.	1. Check CB1 and CB2 - Reset if tripped.	

⚠ CAUTION

If for any reason you do not understand the test procedures or are unable to perform the tests/repairs safely, contact your **Local Lincoln Authorized Field Service Facility** for technical troubleshooting assistance before you proceed.

OUTBACK™ 185



Observe all Safety Guidelines detailed throughout this manual

PROBLEMS (SYMPTOMS)	POSSIBLE CAUSE	RECOMMENDED COURSE OF ACTION
ENGINE PROBLEMS		
Engine will not idle down to low speed.	<ol style="list-style-type: none"> 1. Engine Switch on HIGH Idle. 2. Engine choke is not fully open. 3. External load on welder or auxiliary power. - Remove load. 4. Machine output is under load or Engine switch in wrong position. 5. Idle solenoid does not pull in. 	<p>If all recommended possible areas of misadjustment have been checked and the problem persists, Contact your local Lincoln Authorized Field Service Facility.</p>
Engine idles down to low idle but will not stay at low idle.	<ol style="list-style-type: none"> 1. Engine low idle RPM may be set too low. - Contact Lincoln Field Service Facility. 	
Engine will not go to high idle when attempting to weld or use generator power.	<ol style="list-style-type: none"> 1. Check Work and Electrode cables for loose or faulty connections. 2. Mechanical linkage from solenoid to engine stuck. 3. Open connection in weld circuit. 4. No output from receptacles or load too small. 5. Idler pc board is not sensing output current. 6. Faulty idler pc board. 	
Engine will not go to high idle when using auxiliary power.	<ol style="list-style-type: none"> 1. Auxiliary load less than 100 watts. 2. Circuit breaker CB1 or CB2 tripped or faulty. 3. Mechanical linkage from solenoid to engine stuck. 	
Engine runs erratic or stops running or engine surges at low idle.	<ol style="list-style-type: none"> 1. Oil level may be low activating the engine "Oil Gard" shutdown system. - Check oil level. 2. Idle solenoid linkage or engine idle misadjusted. 	
Recoil starter is hard to pull.	<ol style="list-style-type: none"> 1. Crankcase may be over-filled with oil. - Check oil level. 	
Engine will not start or starts but runs rough with low power.	<ol style="list-style-type: none"> 1. Water in engine from rain and / or condensation. - Remove spark plug and dry it if wet. Blow low pressure compressed air in spark plug port while pulling recoil starter. Re-install spark plug. 2. Spark plug may be faulty. 3. Air filter element saturated with water and / or oil - Replace. 	

CAUTION

If for any reason you do not understand the test procedures or are unable to perform the tests/repairs safely, contact your **Local Lincoln Authorized Field Service Facility** for technical troubleshooting assistance before you proceed.

OUTBACK™ 185



Observe all Safety Guidelines detailed throughout this manual

PROBLEMS (SYMPTOMS)	POSSIBLE CAUSE	RECOMMENDED COURSE OF ACTION
WELDING PROBLEMS		
Engine runs erratically or stops running.	<ol style="list-style-type: none"> 1. Engine is not fully warmed-up and engine choke is in the fully open (RUN) position. 2. Engine requires service to head, carburetor, filters, oil spark plug and / or gas. 3. Oil level to low. 	<p>If all recommended possible areas of misadjustment have been checked and the problem persists, Contact your local Lincoln Authorized Field Service Facility.</p>
Engine sputters but will not start.	<ol style="list-style-type: none"> 1. Bad gas, bad filter, air cleaner, spark plug, and / or breather. 	
Recoil starter is hard to pull.	<ol style="list-style-type: none"> 1. Too much oil in crankcase. 	
Arc is erratic and "pops out".	<ol style="list-style-type: none"> 1. Check Work and Electrode cables for loose or faulty connection. 2. Electrode may be wet. 	
Arc becomes "Cold" at the short Arc lengths or shorts to the work piece.	<ol style="list-style-type: none"> 1. Reset circuit breaker (CB4) located under the Current Control Dial on the bottom side of the control panel. 	

⚠ CAUTION

If for any reason you do not understand the test procedures or are unable to perform the tests/repairs safely, contact your **Local Lincoln Authorized Field Service Facility** for technical troubleshooting assistance before you proceed.

OUTBACK™ 185



WIRING DIAGRAM - OUTBACK 185

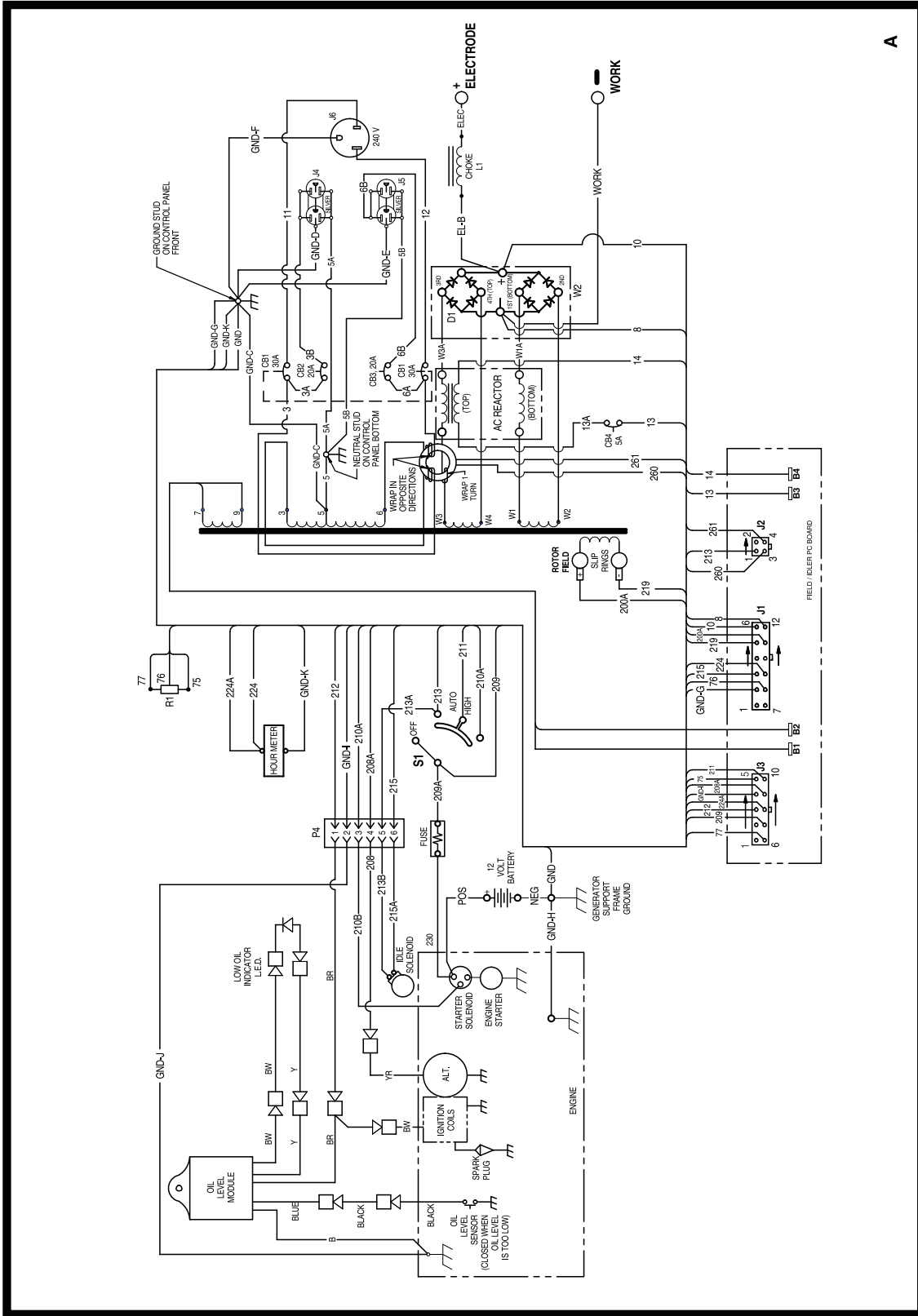

A

L13878

NOTE: This diagram is for reference only. It may not be accurate for all machines covered by this manual. The specific diagram for a particular code is pasted inside the machine on one of the enclosure panels. If the diagram is illegible, write to the Service Department for a replacement. Give the equipment code number.

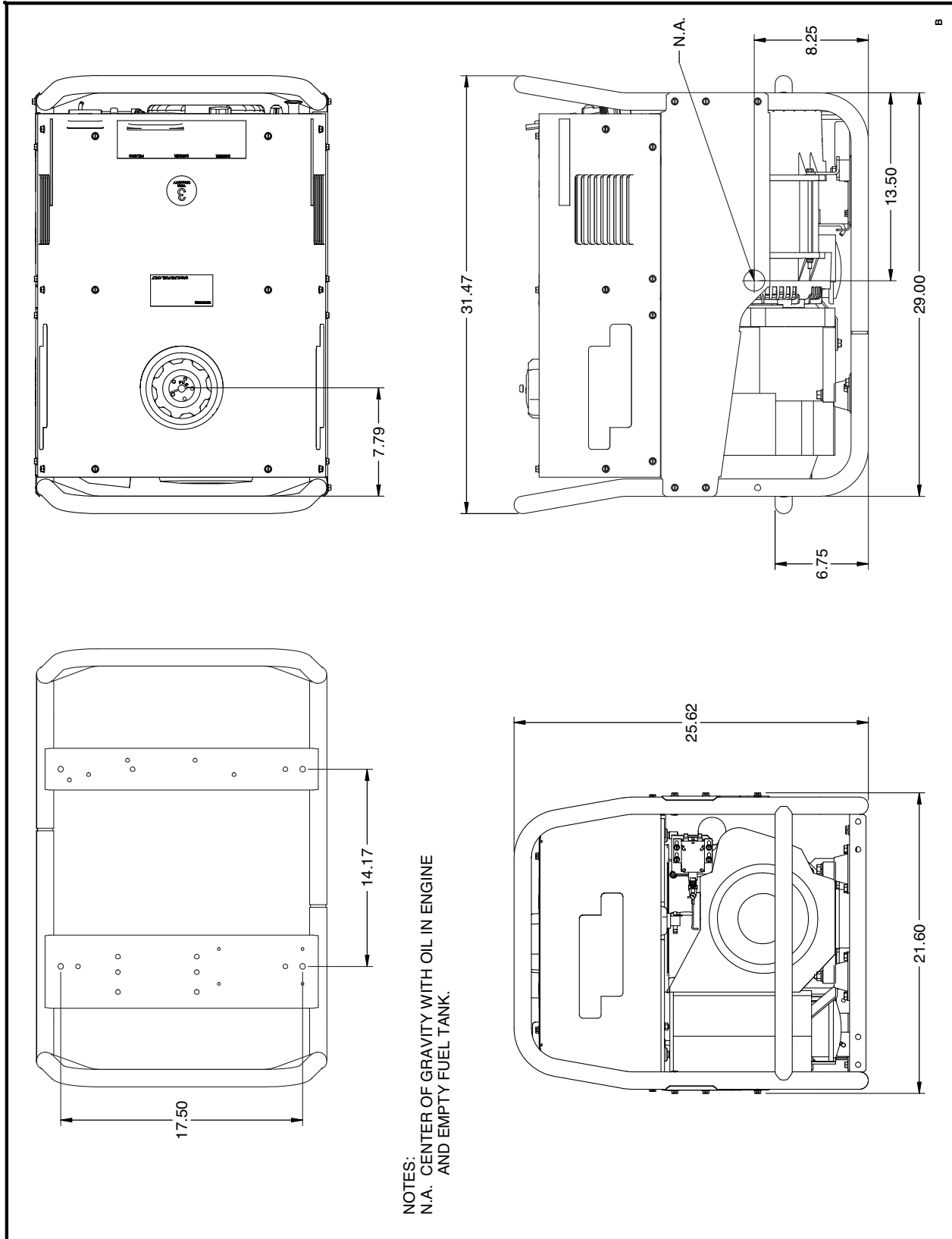

NOTES:
N.A. CENTER OF GRAVITY WITH OIL IN ENGINE
AND EMPTY FUEL TANK.

M21768

OUTBACK™ 185



NOTES

OUTBACK™ 185



			
WARNING	<ul style="list-style-type: none"> Do not touch electrically live parts or electrode with skin or wet clothing. Insulate yourself from work and ground. 	<ul style="list-style-type: none"> Keep flammable materials away. 	<ul style="list-style-type: none"> Wear eye, ear and body protection.
Spanish AVISO DE PRECAUCION	<ul style="list-style-type: none"> No toque las partes o los electrodos bajo carga con la piel o ropa mojada. Aislese del trabajo y de la tierra. 	<ul style="list-style-type: none"> Mantenga el material combustible fuera del área de trabajo. 	<ul style="list-style-type: none"> Protéjase los ojos, los oídos y el cuerpo.
French ATTENTION	<ul style="list-style-type: none"> Ne laissez ni la peau ni des vêtements mouillés entrer en contact avec des pièces sous tension. Isolez-vous du travail et de la terre. 	<ul style="list-style-type: none"> Gardez à l'écart de tout matériel inflammable. 	<ul style="list-style-type: none"> Protégez vos yeux, vos oreilles et votre corps.
German WARNUNG	<ul style="list-style-type: none"> Berühren Sie keine stromführenden Teile oder Elektroden mit Ihrem Körper oder feuchter Kleidung! Isolieren Sie sich von den Elektroden und dem 	<ul style="list-style-type: none"> Entfernen Sie brennbares Material! 	<ul style="list-style-type: none"> Tragen Sie Augen-, Ohren- und Körper-schutz!
Portuguese ATENÇÃO	<ul style="list-style-type: none"> Isolieren Sie sich von den Elektroden und dem 	<ul style="list-style-type: none"> Mantenha inflamáveis bem 	<ul style="list-style-type: none"> Use proteção para a vista, ouvido e corpo.
Japanese 注意事項	<ul style="list-style-type: none"> 通電中の電気部品、又は溶材にヒフやぬれた布で触れないこと。 施工物やアースから身体が絶縁されている様にして下さい。 	<ul style="list-style-type: none"> 燃えやすいものの側での溶接作業は絶対にしてはなりません。 	<ul style="list-style-type: none"> 目、耳及び身体に保護具をして下さい。
Chinese 警告	<ul style="list-style-type: none"> 皮肤或湿衣物切勿接触带电部件及焊条。 使你自己与地面和工作件绝缘。 	<ul style="list-style-type: none"> 把一切易燃物品移离工作场所。 	<ul style="list-style-type: none"> 佩戴眼、耳及身体劳动保护用具。
Korean 위험	<ul style="list-style-type: none"> 전도체나 용접봉을 젖은 형갑 또는 피부로 절대 접촉치 마십시오. 모재와 접지를 접촉치 마십시오. 	<ul style="list-style-type: none"> 인화성 물질을 접근시키지 마십시오. 	<ul style="list-style-type: none"> 눈, 귀와 몸에 보호장구를 착용하십시오.
Arabic تحذير	<ul style="list-style-type: none"> لا تلمس الاجزاء التي يسري فيها التيار الكهربائي أو الألكترود بجند الجسم أو بالملابس المبللة بالماء. ضع عازلا على جسمك خلال العمل. 	<ul style="list-style-type: none"> ضع المواد القابلة للاشتعال في مكان بعيد. 	<ul style="list-style-type: none"> ضع أدوات وملابس واقية على عينيك وأذنيك وجسمك.

READ AND UNDERSTAND THE MANUFACTURER'S INSTRUCTION FOR THIS EQUIPMENT AND THE CONSUMABLES TO BE USED AND FOLLOW YOUR EMPLOYER'S SAFETY PRACTICES.

SE RECOMIENDA LEER Y ENTENDER LAS INSTRUCCIONES DEL FABRICANTE PARA EL USO DE ESTE EQUIPO Y LOS CONSUMIBLES QUE VA A UTILIZAR, SIGA LAS MEDIDAS DE SEGURIDAD DE SU SUPERVISOR.

LISEZ ET COMPRENEZ LES INSTRUCTIONS DU FABRICANT EN CE QUI REGARDE CET EQUIPMENT ET LES PRODUITS A ETRE EMPLOYES ET SUIVEZ LES PROCEDURES DE SECURITE DE VOTRE EMPLOYEUR.

LESEN SIE UND BEFOLGEN SIE DIE BETRIEBSANLEITUNG DER ANLAGE UND DEN ELEKTRODENEINSATZ DES HERSTELLERS. DIE UNFALLVERHÜTUNGSVORSCHRIFTEN DES ARBEITGEBERS

			
<ul style="list-style-type: none"> ● Keep your head out of fumes. ● Use ventilation or exhaust to remove fumes from breathing zone. 	<ul style="list-style-type: none"> ● Turn power off before servicing. 	<ul style="list-style-type: none"> ● Do not operate with panel open or guards off. 	WARNING
<ul style="list-style-type: none"> ● Los humos fuera de la zona de respiración. ● Mantenga la cabeza fuera de los humos. Utilice ventilación o aspiración para gases. 	<ul style="list-style-type: none"> ● Desconectar el cable de alimentación de poder de la máquina antes de iniciar cualquier servicio. 	<ul style="list-style-type: none"> ● No operar con panel abierto o guardas quitadas. 	Spanish AVISO DE PRECAUCION
<ul style="list-style-type: none"> ● Gardez la tête à l'écart des fumées. ● Utilisez un ventilateur ou un aspirateur pour ôter les fumées des zones de travail. 	<ul style="list-style-type: none"> ● Débranchez le courant avant l'entretien. 	<ul style="list-style-type: none"> ● N'opérez pas avec les panneaux ouverts ou avec les dispositifs de protection enlevés. 	French ATTENTION
<ul style="list-style-type: none"> ● Vermeiden Sie das Einatmen von Schweißrauch! ● Sorgen Sie für gute Be- und Entlüftung des Arbeitsplatzes! 	<ul style="list-style-type: none"> ● Strom vor Wartungsarbeiten abschalten! (Netzstrom völlig öffnen; Maschine anhalten!) 	<ul style="list-style-type: none"> ● Anlage nie ohne Schutzgehäuse oder Innenschutzverkleidung in Betrieb setzen! 	German WARNUNG
<ul style="list-style-type: none"> ● Mantenha seu rosto da fumaça. 	<ul style="list-style-type: none"> ● Não opere com as tampas removidas. 	<ul style="list-style-type: none"> ● Mantenha-se afastado das partes moventes. ● Não opere com os painéis 	Portuguese ATENÇÃO
<ul style="list-style-type: none"> ● ヒュームから頭を離すようにして下さい。 ● 換気や排煙に十分留意して下さい。 	<ul style="list-style-type: none"> ● メンテナンス・サービスに取りかかる際には、まず電源スイッチを必ず切して下さい。 	<ul style="list-style-type: none"> ● パネルやカバーを取り外したまま機械操作をしないで下さい。 	Japanese 注意事項
<ul style="list-style-type: none"> ● 頭部遠離煙霧。 ● 在呼吸區使用通風或排風器除煙。 	<ul style="list-style-type: none"> ● 維修前切斷電源。 	<ul style="list-style-type: none"> ● 儀表板打開或沒有安全罩時不準作業。 	Chinese 警告
<ul style="list-style-type: none"> ● 얼굴로부터 용접가스를 멀리하십시오. ● 호흡지역으로부터 용접가스를 제거하기 위해 가스제거기나 통풍기를 사용하십시오. 	<ul style="list-style-type: none"> ● 보수전에 전원을 차단하십시오. 	<ul style="list-style-type: none"> ● 판넬이 열린 상태로 작동치 마십시오. 	Korean 위험
<ul style="list-style-type: none"> ● ابعِد رأسك بعيداً عن الدخان. ● استعمل التهوية أو جهاز ضغط الدخان للخارج لكي تبعد الدخان عن المنطقة التي تتنفس فيها. 	<ul style="list-style-type: none"> ● اقطع التيار الكهربائي قبل القيام بأية صيانة. 	<ul style="list-style-type: none"> ● لا تشغيل هذا الجهاز اذا كانت الاغطية الحديدية الواقية ليست عليه. 	Arabic تحذير

LEIA E COMPREENDA AS INSTRUÇÕES DO FABRICANTE PARA ESTE EQUIPAMENTO E AS PARTES DE USO, E SIGA AS PRÁTICAS DE SEGURANÇA DO EMPREGADOR.

使う機械や溶材のメーカーの指示書をよく読み、まず理解して下さい。そして貴社の安全規定に従って下さい。

請詳細閱讀並理解製造廠提供的說明以及應該使用的銀焊材料，並請遵守貴方的有閣勞動保護規定。

이 제품에 동봉된 작업지침서를 숙지하시고 귀사의 작업자 안전수칙을 준수하시기 바랍니다.

اقرأ بتمعن وافهم تعليمات المصنع المنتج لهذه المعدات والمواد قبل استعمالها واتبع تعليمات الوقاية لصاحب العمل.



• World's Leader in Welding and Cutting Products •

• Sales and Service through Subsidiaries and Distributors Worldwide •

Cleveland, Ohio 44117-1199 U.S.A. TEL: 216.481.8100 FAX: 216.486.1751 WEB SITE: www.lincolnelectric.com

Download from Www.Somanuals.com. All Manuals Search And Download.

Free Manuals Download Website

<http://myh66.com>

<http://usermanuals.us>

<http://www.somanuals.com>

<http://www.4manuals.cc>

<http://www.manual-lib.com>

<http://www.404manual.com>

<http://www.luxmanual.com>

<http://aubethermostatmanual.com>

Golf course search by state

<http://golfingnear.com>

Email search by domain

<http://emailbydomain.com>

Auto manuals search

<http://auto.somanuals.com>

TV manuals search

<http://tv.somanuals.com>