

INVERTEC[®] V31 1-TAC/DC

For use with machines having Code Numbers: **11685**

Safety Depends on You

Lincoln arc welding and cutting equipment is designed and built with safety in mind. However, your overall safety can be increased by proper installation ... and thoughtful operation on your part. **DO NOT INSTALL, OPERATE OR REPAIR THIS EQUIPMENT WITHOUT READING THIS MANUAL AND THE SAFETY PRECAUTIONS CONTAINED THROUGHOUT.** And, most importantly, think before you act and be careful.

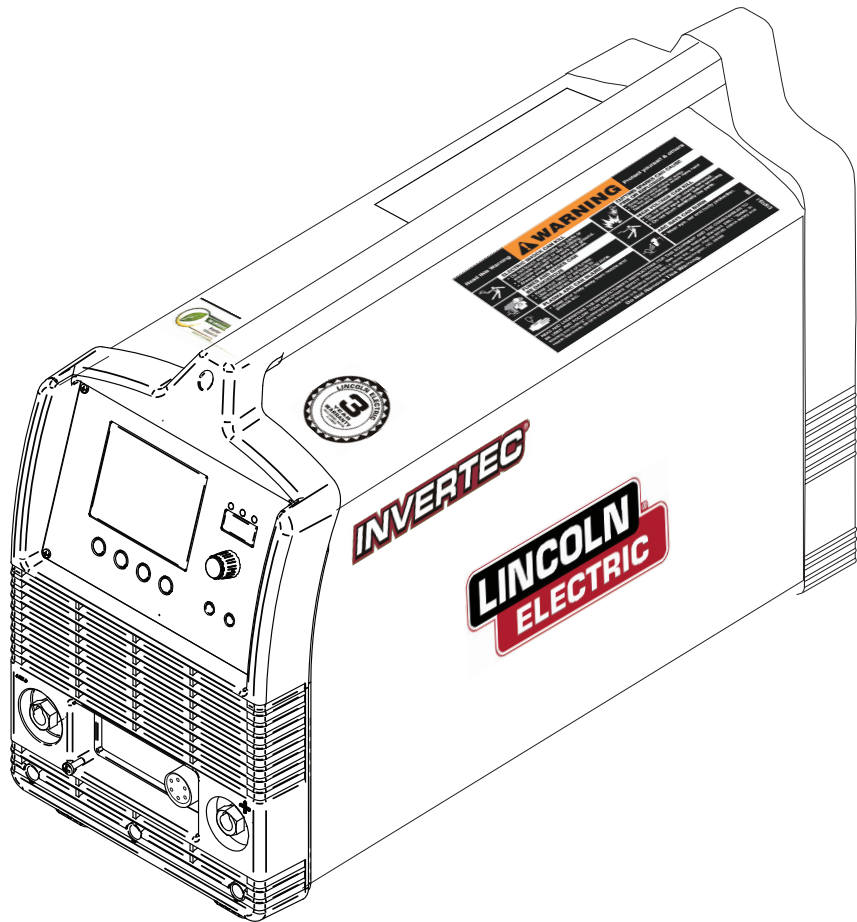

OPERATOR'S MANUAL



Copyright © Lincoln Global Inc.

• World's Leader in Welding and Cutting Products •

• Sales and Service through Subsidiaries and Distributors Worldwide •

Cleveland, Ohio 44117-1199 U.S.A. TEL: 216.481.8100 FAX: 216.486.1751 WEB SITE: www.lincolnelectric.com

Download from Www.Somanuals.com. All Manuals Search And Download.

⚠ WARNING



CALIFORNIA PROPOSITION 65 WARNINGS



Diesel engine exhaust and some of its constituents are known to the State of California to cause cancer, birth defects, and other reproductive harm.

The Above For Diesel Engines

The engine exhaust from this product contains chemicals known to the State of California to cause cancer, birth defects, or other reproductive harm.

The Above For Gasoline Engines

ARC WELDING CAN BE HAZARDOUS. PROTECT YOURSELF AND OTHERS FROM POSSIBLE SERIOUS INJURY OR DEATH. KEEP CHILDREN AWAY. PACEMAKER WEARERS SHOULD CONSULT WITH THEIR DOCTOR BEFORE OPERATING.

Read and understand the following safety highlights. For additional safety information, it is strongly recommended that you purchase a copy of "Safety in Welding & Cutting - ANSI Standard Z49.1" from the American Welding Society, P.O. Box 351040, Miami, Florida 33135 or CSA Standard W117.2-1974. A Free copy of "Arc Welding Safety" booklet E205 is available from the Lincoln Electric Company, 22801 St. Clair Avenue, Cleveland, Ohio 44117-1199.

BE SURE THAT ALL INSTALLATION, OPERATION, MAINTENANCE AND REPAIR PROCEDURES ARE PERFORMED ONLY BY QUALIFIED INDIVIDUALS.



FOR ENGINE powered equipment.

1.a. Turn the engine off before troubleshooting and maintenance work unless the maintenance work requires it to be running.



1.b. Operate engines in open, well-ventilated areas or vent the engine exhaust fumes outdoors.



1.c. Do not add the fuel near an open flame welding arc or when the engine is running. Stop the engine and allow it to cool before refueling to prevent spilled fuel from vaporizing on contact with hot engine parts and igniting. Do not spill fuel when filling tank. If fuel is spilled, wipe it up and do not start engine until fumes have been eliminated.

1.d. Keep all equipment safety guards, covers and devices in position and in good repair. Keep hands, hair, clothing and tools away from V-belts, gears, fans and all other moving parts when starting, operating or repairing equipment.

1.e. In some cases it may be necessary to remove safety guards to perform required maintenance. Remove guards only when necessary and replace them when the maintenance requiring their removal is complete. Always use the greatest care when working near moving parts.



1.f. Do not put your hands near the engine fan. Do not attempt to override the governor or idler by pushing on the throttle control rods while the engine is running.

1.g. To prevent accidentally starting gasoline engines while turning the engine or welding generator during maintenance work, disconnect the spark plug wires, distributor cap or magneto wire as appropriate.



1.h. To avoid scalding, do not remove the radiator pressure cap when the engine is hot.



ELECTRIC AND MAGNETIC FIELDS may be dangerous

- 2.a. Electric current flowing through any conductor causes localized Electric and Magnetic Fields (EMF). Welding current creates EMF fields around welding cables and welding machines
- 2.b. EMF fields may interfere with some pacemakers, and welders having a pacemaker should consult their physician before welding.
- 2.c. Exposure to EMF fields in welding may have other health effects which are now not known.
- 2.d. All welders should use the following procedures in order to minimize exposure to EMF fields from the welding circuit:
 - 2.d.1. Route the electrode and work cables together - Secure them with tape when possible.
 - 2.d.2. Never coil the electrode lead around your body.
 - 2.d.3. Do not place your body between the electrode and work cables. If the electrode cable is on your right side, the work cable should also be on your right side.
 - 2.d.4. Connect the work cable to the workpiece as close as possible to the area being welded.
 - 2.d.5. Do not work next to welding power source.

Mar '95



ELECTRIC SHOCK can kill.

- 3.a. The electrode and work (or ground) circuits are electrically "hot" when the welder is on. Do not touch these "hot" parts with your bare skin or wet clothing. Wear dry, hole-free gloves to insulate hands.
- 3.b. Insulate yourself from work and ground using dry insulation. Make certain the insulation is large enough to cover your full area of physical contact with work and ground.

In addition to the normal safety precautions, if welding must be performed under electrically hazardous conditions (in damp locations or while wearing wet clothing; on metal structures such as floors, gratings or scaffolds; when in cramped positions such as sitting, kneeling or lying, if there is a high risk of unavoidable or accidental contact with the workpiece or ground) use the following equipment:

- Semiautomatic DC Constant Voltage (Wire) Welder.
 - DC Manual (Stick) Welder.
 - AC Welder with Reduced Voltage Control.
- 3.c. In semiautomatic or automatic wire welding, the electrode, electrode reel, welding head, nozzle or semiautomatic welding gun are also electrically "hot".
- 3.d. Always be sure the work cable makes a good electrical connection with the metal being welded. The connection should be as close as possible to the area being welded.
- 3.e. Ground the work or metal to be welded to a good electrical (earth) ground.
- 3.f. Maintain the electrode holder, work clamp, welding cable and welding machine in good, safe operating condition. Replace damaged insulation.
- 3.g. Never dip the electrode in water for cooling.
- 3.h. Never simultaneously touch electrically "hot" parts of electrode holders connected to two welders because voltage between the two can be the total of the open circuit voltage of both welders.
- 3.i. When working above floor level, use a safety belt to protect yourself from a fall should you get a shock.
- 3.j. Also see Items 6.c. and 8.



ARC RAYS can burn.

- 4.a. Use a shield with the proper filter and cover plates to protect your eyes from sparks and the rays of the arc when welding or observing open arc welding. Headshield and filter lens should conform to ANSI Z87.1 standards.
- 4.b. Use suitable clothing made from durable flame-resistant material to protect your skin and that of your helpers from the arc rays.
- 4.c. Protect other nearby personnel with suitable, non-flammable screening and/or warn them not to watch the arc nor expose themselves to the arc rays or to hot spatter or metal.



FUMES AND GASES can be dangerous.

- 5.a. Welding may produce fumes and gases hazardous to health. Avoid breathing these fumes and gases. When welding, keep your head out of the fume. Use enough ventilation and/or exhaust at the arc to keep fumes and gases away from the breathing zone. **When welding with electrodes which require special ventilation such as stainless or hard facing (see instructions on container or MSDS) or on lead or cadmium plated steel and other metals or coatings which produce highly toxic fumes, keep exposure as low as possible and within applicable OSHA PEL and ACGIH TLV limits using local exhaust or mechanical ventilation. In confined spaces or in some circumstances, outdoors, a respirator may be required. Additional precautions are also required when welding on galvanized steel.**
5. b. The operation of welding fume control equipment is affected by various factors including proper use and positioning of the equipment, maintenance of the equipment and the specific welding procedure and application involved. Worker exposure level should be checked upon installation and periodically thereafter to be certain it is within applicable OSHA PEL and ACGIH TLV limits.
- 5.c. Do not weld in locations near chlorinated hydrocarbon vapors coming from degreasing, cleaning or spraying operations. The heat and rays of the arc can react with solvent vapors to form phosgene, a highly toxic gas, and other irritating products.
- 5.d. Shielding gases used for arc welding can displace air and cause injury or death. Always use enough ventilation, especially in confined areas, to insure breathing air is safe.
- 5.e. Read and understand the manufacturer's instructions for this equipment and the consumables to be used, including the material safety data sheet (MSDS) and follow your employer's safety practices. MSDS forms are available from your welding distributor or from the manufacturer.
- 5.f. Also see item 1.b.

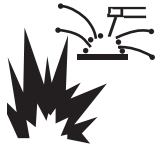

WELDING and CUTTING SPARKS can cause fire or explosion.

6.a. Remove fire hazards from the welding area. If this is not possible, cover them to prevent the welding sparks from starting a fire.

Remember that welding sparks and hot materials from welding can easily go through small cracks and openings to adjacent areas. Avoid welding near hydraulic lines. Have a fire extinguisher readily available.

- 6.b. Where compressed gases are to be used at the job site, special precautions should be used to prevent hazardous situations. Refer to "Safety in Welding and Cutting" (ANSI Standard Z49.1) and the operating information for the equipment being used.
- 6.c. When not welding, make certain no part of the electrode circuit is touching the work or ground. Accidental contact can cause overheating and create a fire hazard.
- 6.d. Do not heat, cut or weld tanks, drums or containers until the proper steps have been taken to insure that such procedures will not cause flammable or toxic vapors from substances inside. They can cause an explosion even though they have been "cleaned". For information, purchase "Recommended Safe Practices for the Preparation for Welding and Cutting of Containers and Piping That Have Held Hazardous Substances", AWS F4.1 from the American Welding Society (see address above).
- 6.e. Vent hollow castings or containers before heating, cutting or welding. They may explode.
- 6.f. Sparks and spatter are thrown from the welding arc. Wear oil free protective garments such as leather gloves, heavy shirt, cuffless trousers, high shoes and a cap over your hair. Wear ear plugs when welding out of position or in confined places. Always wear safety glasses with side shields when in a welding area.
- 6.g. Connect the work cable to the work as close to the welding area as practical. Work cables connected to the building framework or other locations away from the welding area increase the possibility of the welding current passing through lifting chains, crane cables or other alternate circuits. This can create fire hazards or overheat lifting chains or cables until they fail.
- 6.h. Also see item 1.c.
- 6.i. Read and follow NFPA 51B "Standard for Fire Prevention During Welding, Cutting and Other Hot Work", available from NFPA, 1 Batterymarch Park, PO box 9101, Quincy, Ma 022690-9101.
- 6.j. Do not use a welding power source for pipe thawing.

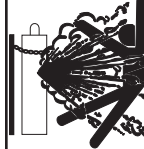

CYLINDER may explode if damaged.

7.a. Use only compressed gas cylinders containing the correct shielding gas for the process used and properly operating regulators designed for the gas and pressure used. All hoses, fittings, etc. should be suitable for the application and maintained in good condition.

- 7.b. Always keep cylinders in an upright position securely chained to an undercarriage or fixed support.
- 7.c. Cylinders should be located:
 - Away from areas where they may be struck or subjected to physical damage.
 - A safe distance from arc welding or cutting operations and any other source of heat, sparks, or flame.
- 7.d. Never allow the electrode, electrode holder or any other electrically "hot" parts to touch a cylinder.
- 7.e. Keep your head and face away from the cylinder valve outlet when opening the cylinder valve.
- 7.f. Valve protection caps should always be in place and hand tight except when the cylinder is in use or connected for use.
- 7.g. Read and follow the instructions on compressed gas cylinders, associated equipment, and CGA publication P-1, "Precautions for Safe Handling of Compressed Gases in Cylinders," available from the Compressed Gas Association 1235 Jefferson Davis Highway, Arlington, VA 22202.



FOR ELECTRICALLY powered equipment.

- 8.a. Turn off input power using the disconnect switch at the fuse box before working on the equipment.
- 8.b. Install equipment in accordance with the U.S. National Electrical Code, all local codes and the manufacturer's recommendations.
- 8.c. Ground the equipment in accordance with the U.S. National Electrical Code and the manufacturer's recommendations.

Refer to <http://www.lincolnelectric.com/safety> for additional safety information.

PRÉCAUTIONS DE SÛRETÉ

Pour votre propre protection lire et observer toutes les instructions et les précautions de sûreté spécifiques qui paraissent dans ce manuel aussi bien que les précautions de sûreté générales suivantes:

Sûreté Pour Soudage A L'Arc

1. Protégez-vous contre la secousse électrique:
 - a. Les circuits à l'électrode et à la pièce sont sous tension quand la machine à souder est en marche. Eviter toujours tout contact entre les parties sous tension et la peau nue ou les vêtements mouillés. Porter des gants secs et sans trous pour isoler les mains.
 - b. Faire très attention de bien s'isoler de la masse quand on soude dans des endroits humides, ou sur un plancher métallique ou des grilles métalliques, principalement dans les positions assis ou couché pour lesquelles une grande partie du corps peut être en contact avec la masse.
 - c. Maintenir le porte-électrode, la pince de masse, le câble de soudage et la machine à souder en bon et sûr état de fonctionnement.
 - d. Ne jamais plonger le porte-électrode dans l'eau pour le refroidir.
 - e. Ne jamais toucher simultanément les parties sous tension des porte-électrodes connectés à deux machines à souder parce que la tension entre les deux pinces peut être le total de la tension à vide des deux machines.
 - f. Si on utilise la machine à souder comme une source de courant pour soudage semi-automatique, ces précautions pour le porte-électrode s'appliquent aussi au pistolet de soudage.
2. Dans le cas de travail au dessus du niveau du sol, se protéger contre les chutes dans le cas où on recoit un choc. Ne jamais enrouler le câble-électrode autour de n'importe quelle partie du corps.
3. Un coup d'arc peut être plus sévère qu'un coup de soliel, donc:
 - a. Utiliser un bon masque avec un verre filtrant approprié ainsi qu'un verre blanc afin de se protéger les yeux du rayonnement de l'arc et des projections quand on soude ou quand on regarde l'arc.
 - b. Porter des vêtements convenables afin de protéger la peau de soudeur et des aides contre le rayonnement de l'arc.
 - c. Protéger l'autre personnel travaillant à proximité au soudage à l'aide d'écrans appropriés et non-inflammables.
4. Des gouttes de laitier en fusion sont émises de l'arc de soudage. Se protéger avec des vêtements de protection libres de l'huile, tels que les gants en cuir, chemise épaisse, pantalons sans revers, et chaussures montantes.
5. Toujours porter des lunettes de sécurité dans la zone de soudage. Utiliser des lunettes avec écrans latéraux dans les zones où l'on pique le laitier.

6. Eloigner les matériaux inflammables ou les recouvrir afin de prévenir tout risque d'incendie dû aux étincelles.
7. Quand on ne soude pas, poser la pince à un endroit isolé de la masse. Un court-circuit accidentel peut provoquer un échauffement et un risque d'incendie.
8. S'assurer que la masse est connectée le plus près possible de la zone de travail qu'il est pratique de le faire. Si on place la masse sur la charpente de la construction ou d'autres endroits éloignés de la zone de travail, on augmente le risque de voir passer le courant de soudage par les chaînes de levage, câbles de grue, ou autres circuits. Cela peut provoquer des risques d'incendie ou d'échauffement des chaînes et des câbles jusqu'à ce qu'ils se rompent.
9. Assurer une ventilation suffisante dans la zone de soudage. Ceci est particulièrement important pour le soudage de tôles galvanisées plombées, ou cadmiées ou tout autre métal qui produit des fumeés toxiques.
10. Ne pas souder en présence de vapeurs de chlore provenant d'opérations de dégraissage, nettoyage ou pistolage. La chaleur ou les rayons de l'arc peuvent réagir avec les vapeurs du solvant pour produire du phosgène (gas fortement toxique) ou autres produits irritants.
11. Pour obtenir de plus amples renseignements sur la sûreté, voir le code "Code for safety in welding and cutting" CSA Standard W 117.2-1974.

PRÉCAUTIONS DE SÛRETÉ POUR LES MACHINES À SOUDER À TRANSFORMATEUR ET À REDRESSEUR

1. Relier à la terre le chassis du poste conformément au code de l'électricité et aux recommandations du fabricant. Le dispositif de montage ou la pièce à souder doit être branché à une bonne mise à la terre.
2. Autant que possible, l'installation et l'entretien du poste seront effectués par un électricien qualifié.
3. Avant de faire des travaux à l'intérieur de poste, la débrancher à l'interrupteur à la boîte de fusibles.
4. Garder tous les couvercles et dispositifs de sûreté à leur place.

Mar. '93

Electromagnetic Compatibility (EMC)

Conformance

Products displaying the CE mark are in conformity with European Community Council Directive of 3 May 1989 on the approximation of the laws of the Member States relating to electromagnetic compatibility (89/336/EEC). It was manufactured in conformity with a national standard that implements a harmonized standard: **EN 60974-10** Electromagnetic Compatibility (EMC) Product Standard for Arc Welding Equipment. It is for use with other Lincoln Electric equipment. It is designed for industrial and professional use.

Introduction

All electrical equipment generates small amounts of electromagnetic emission. Electrical emission may be transmitted through power lines or radiated through space, similar to a radio transmitter. When emissions are received by other equipment, electrical interference may result. Electrical emissions may affect many kinds of electrical equipment; other nearby welding equipment, radio and TV reception, numerical controlled machines, telephone systems, computers, etc. Be aware that interference may result and extra precautions may be required when a welding power source is used in a domestic establishment.

Installation and Use

The user is responsible for installing and using the welding equipment according to the manufacturer's instructions. If electromagnetic disturbances are detected then it shall be the responsibility of the user of the welding equipment to resolve the situation with the technical assistance of the manufacturer. In some cases this remedial action may be as simple as earthing (grounding) the welding circuit, see Note. In other cases it could involve construction an electromagnetic screen enclosing the power source and the work complete with associated input filters. In all cases electromagnetic disturbances must be reduced to the point where they are no longer troublesome.

Note: The welding circuit may or may not be earthed for safety reasons according to national codes. Changing the earthing arrangements should only be authorized by a person who is competent to access whether the changes will increase the risk of injury, e.g., by allowing parallel welding current return paths which may damage the earth circuits of other equipment.

Assessment of Area

Before installing welding equipment the user shall make an assessment of potential electromagnetic problems in the surrounding area. The following shall be taken into account:

- a) other supply cables, control cables, signaling and telephone cables; above, below and adjacent to the welding equipment;
- b) radio and television transmitters and receivers;
- c) computer and other control equipment;
- d) safety critical equipment, e.g., guarding of industrial equipment;
- e) the health of the people around, e.g., the use of pacemakers and hearing aids;
- f) equipment used for calibration or measurement
- g) the immunity of other equipment in the environment. The user shall ensure that other equipment being used in the environment is compatible. This may require additional protection measures;
- h) the time of day that welding or other activities are to be carried out.

L10093 3-1-96H

Electromagnetic Compatibility (EMC)

The size of the surrounding area to be considered will depend on the structure of the building and other activities that are taking place. The surrounding area may extend beyond the boundaries of the premises.

Methods of Reducing Emissions

Mains Supply

Welding equipment should be connected to the mains supply according to the manufacturer's recommendations. If interference occurs, it may be necessary to take additional precautions such as filtering of the mains supply. Consideration should be given to shielding the supply cable of permanently installed welding equipment, in metallic conduit or equivalent. Shielding should be electrically continuous throughout its length. The shielding should be connected to the welding power source so that good electrical contact is maintained between the conduit and the welding power source enclosure.

Maintenance of the Welding Equipment

The welding equipment should be routinely maintained according to the manufacturer's recommendations. All access and service doors and covers should be closed and properly fastened when the welding equipment is in operation. The welding equipment should not be modified in any way except for those changes and adjustments covered in the manufacturer's instructions. In particular, the spark gaps of arc striking and stabilizing devices should be adjusted and maintained according to the manufacturer's recommendations.

Welding Cables

The welding cables should be kept as short as possible and should be positioned close together, running at or close to floor level.

Equipotential Bonding

Bonding of all metallic components in the welding installation and adjacent to it should be considered. However, metallic components bonded to the work piece will increase the risk that the operator could receive a shock by touching these metallic components and the electrode at the same time. The operator should be insulated from all such bonded metallic components.

Earthing of the Workpiece

Where the workpiece is not bonded to earth for electrical safety, not connected to earth because of its size and position, e.g., ships hull or building steelwork, a connection bonding the workpiece to earth may reduce emissions in some, but not all instances. Care should be taken to prevent the earthing of the workpiece increasing the risk of injury to users, or damage to other electrical equipment. Where necessary, the connection of the workpiece to earth should be made by a direct connection to the workpiece, but in some countries where direct connection is not permitted, the bonding should be achieved by suitable capacitance, selected according to national regulations.

Screening and Shielding

Selective screening and shielding of other cables and equipment in the surrounding area may alleviate problems of interference. Screening of the entire welding installation may be considered for special applications.¹

¹ Portions of the preceding text are contained in EN 60974-10: "Electromagnetic Compatibility (EMC) product standard for arc welding equipment."

Thank You

for selecting a **QUALITY** product by Lincoln Electric. We want you to take pride in operating this Lincoln Electric Company product
••• as much pride as we have in bringing this product to you!

CUSTOMER ASSISTANCE POLICY

The business of The Lincoln Electric Company is manufacturing and selling high quality welding equipment, consumables, and cutting equipment. Our challenge is to meet the needs of our customers and to exceed their expectations. On occasion, purchasers may ask Lincoln Electric for advice or information about their use of our products. We respond to our customers based on the best information in our possession at that time. Lincoln Electric is not in a position to warrant or guarantee such advice, and assumes no liability, with respect to such information or advice. We expressly disclaim any warranty of any kind, including any warranty of fitness for any customer's particular purpose, with respect to such information or advice. As a matter of practical consideration, we also cannot assume any responsibility for updating or correcting any such information or advice once it has been given, nor does the provision of information or advice create, expand or alter any warranty with respect to the sale of our products.

Lincoln Electric is a responsive manufacturer, but the selection and use of specific products sold by Lincoln Electric is solely within the control of, and remains the sole responsibility of the customer. Many variables beyond the control of Lincoln Electric affect the results obtained in applying these types of fabrication methods and service requirements.

Subject to Change – This information is accurate to the best of our knowledge at the time of printing. Please refer to www.lincolnelectric.com for any updated information.

Please Examine Carton and Equipment For Damage Immediately

When this equipment is shipped, title passes to the purchaser upon receipt by the carrier. Consequently, Claims for material damaged in shipment must be made by the purchaser against the transportation company at the time the shipment is received.

Please record your equipment identification information below for future reference. This information can be found on your machine nameplate.

Product _____

Model Number _____

Code Number or Date Code _____

Serial Number _____

Date Purchased _____

Where Purchased _____

Whenever you request replacement parts or information on this equipment, always supply the information you have recorded above. The code number is especially important when identifying the correct replacement parts.

On-Line Product Registration

- Register your machine with Lincoln Electric either via fax or over the Internet.
 - For faxing: Complete the form on the back of the warranty statement included in the literature packet accompanying this machine and fax the form per the instructions printed on it.
 - For On-Line Registration: Go to our **WEB SITE at www.lincolnelectric.com**. Choose "Quick Links" and then "Product Registration". Please complete the form and submit your registration.

Read this Operators Manual completely before attempting to use this equipment. Save this manual and keep it handy for quick reference. Pay particular attention to the safety instructions we have provided for your protection. The level of seriousness to be applied to each is explained below:

WARNING

This statement appears where the information **must** be followed **exactly** to avoid **serious personal injury** or **loss of life**.

CAUTION

This statement appears where the information **must** be followed to avoid **minor personal injury** or **damage to this equipment**.

	Page
Installation	Section A
Technical Specifications.....	A-1
Select Suitable Location.....	A-2
Stacking.....	A-2
Tilting.....	A-2
Environmental Area.....	A-2
Machine Grounding and High Frequency Interference Protection.....	A-2
Input Connections.....	A-3
Reconnect Procedure.....	A-3
Input Plug Installation.....	A-4
Engine Drive Generator.....	A-4
Output Connections.....	A-5
Output and Gas Connection for Tig Welding.....	A-5
Work Cable Connection.....	A-5
Output Connection for Stick Welding.....	A-5
Quick Disconnect Plug.....	A-6
Shielding Gas Connection.....	A-6
Remote Control Connection.....	A-6
<hr/>	
Operation	Section B
Safety Instructions.....	B-1
General Description.....	B-1
Welding Capability.....	B-1
Limitations.....	B-1
Rear Control Panel.....	B-2
Lower Control Panel.....	B-2
User Interface Overview and Operation.....	B-3
Dynamic LCD Display.....	B-4, B-5, B-6
Welding Parameter.....	B-7
User Menu Set Up Parameters.....	B-8
Set Up Menu Parameters, Optional Cool-Arc 35 Water Cooler.....	B-9, B-10
Tips For Improved TIG Starting, Stick Crisp Mode Dynamic Current Regulation.....	B-11
<hr/>	
Accessories	Section C
Optional Accessories and Compatible Equipment.....	C-1
Factory, Field Installed.....	C-1, C-2
<hr/>	
Maintenance	Section D
Safety Precautions.....	D-1
Input Filter Capacitor Discharge Procedure.....	D-1
Routine Maintenance.....	D-1
<hr/>	
Troubleshooting	Section E
How to Use Troubleshooting Guide.....	E-1
Troubleshooting Guide.....	E-2 thru E-5
<hr/>	
Wiring Diagram	Section F
<hr/>	
Parts Lists	P-643
<hr/>	

TECHNICAL SPECIFICATIONS - INVERTEC® V311-T AC/DC TIG K2915-1

RATED OUTPUT				
Input Power		Rated Output Current, Voltage, Duty Cycle (104°F, 40°C)		Input Current @ Rated Output
Phase	Voltage/ Hertz			
Three-Phase	460/50/60	TIG	210A / 18.4V / 100%	7.3A
			230A / 19.2V / 60%	8.3A
			310A / 22.4V / 40%	12.3A
		STICK	200A / 28.0V / 100%	9.6A
			220A / 28.8V / 60%	10.7A
			270A / 30.8V / 40%	13.8A
	230/50/60	TIG	210A / 18.4V / 100%	13.9A
			230A / 19.2V / 60%	15.8A
			310A / 22.4V / 30%	24.6A
		STICK	200A / 28.0V / 100%	18.7A
			220A / 28.8V / 60%	20.9A
			270A / 30.8V / 35%	27.7A
208/50/60	TIG	210A / 18.4V / 100%	15.3A	
		230A / 19.2V / 60%	17.5A	
		310A / 22.4V / 30%	27.3A	
	STICK	200A / 28.0V / 100%	20.5A	
		220A / 28.8V / 60%	23.6A	
		270A / 30.8V / 35%	30.8A	
Single-Phase	460/50/60	TIG	200A / 18.0V / 100%	13.6A
			220A / 18.8V / 60%	14.9A
			310A / 22.4V / 35%	23.1A
		STICK	190A / 27.6V / 100%	17.2A
			210A / 28.4V / 60%	19.4A
			270A / 30.8V / 35%	25.7A
	230/50/60	TIG	200A / 18.0V / 100%	21.9A
			220A / 18.8V / 60%	24.6A
			310A / 22.4V / 25%	41.5A
		STICK	190A / 27.6V / 100%	29.2A
			210A / 28.4V / 60%	33.2A
			270A / 30.8V / 30%	47.1A
208/50/60	TIG	200A / 18.0V / 100%	24.2A	
		220A / 18.8V / 60%	27.7A	
		310A / 22.4V / 25%	47.3A	
	STICK	190A / 27.6V / 100%	32.1A	
		210A / 28.4V / 60%	37.3A	
		270A / 30.8V / 30%	52.5A	
OUTPUT RANGE				
Output Current Range		Maximum Open Circuit Voltage		Type of Output
5-310 Amps		80 Volts Max.		AC/DC
RECOMMENDED INPUT WIRE AND FUZE SIZES FOR MAXIMUM OUTPUT				
Input Voltage/Frequency (Hz)		Type S, SO, STO, or other EXTRA HARD USAGE Input Cord		Maximum Time-Delay Circuit Breaker or Fuse Size (Amps)
208/230/460/50/60		10 AWG, 4 Conductor		60
PHYSICAL DIMENSIONS				
Height	Width	Depth	Weight	
17.0 in. 432 mm	11.0 in. 280 mm	24.5 in. 622 mm	Approx. 75 lbs. 34.0 kgs.	
TEMPERATURE RANGES				
OPERATING TEMPERATURE RANGE			STORAGE TEMPERATURE RANGE	
-20°C to +40°C			-50°C to +85°C	

INVERTEC® V311-T AC/DC TIG



Read entire installation section before starting installation.

Safety Precautions

⚠ WARNING



ELECTRIC SHOCK can kill.

- Only qualified personnel should perform this installation.
- Turn the input power **OFF** and unplug the machine from the receptacle before working on this equipment. Allow machine to sit for 5 minutes minimum to allow the power capacitors to discharge before working inside this equipment.

- Insulate yourself from the work and ground.
- Always wear dry insulating gloves.
- Always connect the Invertec® V311-T AC/DC TIG to a power supply grounded according to the National Electrical Code and local codes.

SELECT SUITABLE LOCATION

The Invertec® V311-T AC/DC TIG will operate in harsh environments. Even so, it is important that simple preventative measures are followed in order to assure long life and reliable operation.

- The machine must be located where there is free circulation of clean air such that air movement in the back and out the front will not be restricted.
- Dirt and dust that can be drawn into the machine should be kept to a minimum. Failure to observe these precautions can result in excessive operating temperatures and nuisance shutdown.

STACKING

The Invertec® V311-T AC/DC TIG can not be stacked.

TILTING

Place the machine directly on a secure, level surface. The machine may topple over if this procedure is not followed.

ENVIRONMENTAL AREA

Keep the machine dry. Do not place it on wet ground or in puddles.

MACHINE GROUNDING AND HIGH FREQUENCY INTERFERENCE PROTECTION

The Capacitor Discharge Circuit used in the high frequency generator, may cause many radio, TV and electronic equipment interference problems. These problems may be the result of radiated interference. Proper grounding methods can reduce or eliminate radiated interference.

The Invertec® V311-T AC/DC TIG has been field tested under recommended installation conditions. It complies with FCC allowable limits for radiation.

Radiated interference can develop in the following four ways:

1. Direct interference radiated from the welder.
2. Direct interference radiated from the welding leads.
3. Direct interference radiated from feedback into the power lines.
4. Interference from re-radiation of "pickup" by ungrounded metallic objects.

Keeping these contributing factors in mind, installing equipment per the following instructions should minimize problems.

1. Keep the welder power supply lines as short as possible and enclose as much of them as possible in rigid metallic conduit or equivalent shielding for a distance of 50 feet (15.2m). There should be good electrical contact between this conduit and the welder case ground. Both ends of the conduit should be connected to a driven ground and the entire length should be continuous.
2. Keep the work and electrode leads as short as possible and as close together as possible. Lengths should not exceed 25 ft (7.6m).
3. Be sure the torch and work cable rubber coverings are free of cuts and cracks that allow high frequency leakage. Cables with high natural rubber content, such as Lincoln Stable-Arc® better resist high frequency leakage than neoprene and other synthetic rubber insulated cables.
4. Keep the torch in good repair and all connections tight to reduce high frequency leakage.

INVERTEC® V311-T AC/DC TIG



5. The work terminal must be connected to a ground within ten feet of the welder, using one of the following methods.
 - a) A metal underground water pipe in direct contact with the earth for ten feet or more.
 - b) A 3/4" (19mm) galvanized pipe or a 5/8" (16mm) solid galvanized iron, steel or copper rod driven at least eight feet into the ground.

The ground should be securely made and the grounding cable should be as short as possible using cable of the same size as the work cable, or larger. Grounding to the building frame electrical conduit or a long pipe system can result in re-radiation, effectively making these members radiating antennas.

6. Keep all panels securely in place.
7. All electrical conductors within 50 ft (15.2m) of the welder should be enclosed in grounded, rigid metallic conduit or equivalent shielding. Flexible metallic conduit is generally not suitable.
8. When the welder is enclosed in a metal building, several earth driven electrical grounds connected (as in 5b above) around the periphery of the building are recommended.

Failure to observe these recommended installation procedures can cause radio or TV interference problems.

INPUT CONNECTIONS

Be sure the voltage, phase, and frequency of the input power is as specified on the rating plate, located on the bottom of the machine.

WARNING

ELECTRIC SHOCK can kill.



- Have a qualified electrician install and service this equipment.
- Turn the input power OFF and unplug the machine from the receptacle before working on this equipment.

- Allow machine to sit for 5 minutes minimum to allow the power capacitors to discharge before working inside this equipment.
- Do not touch electrically hot parts.
- Machine must be plugged into a receptacle that is grounded according to the National Electrical Code and local codes.
- Do not remove or defeat the purpose of the power cord ground pin.

RECONNECT PROCEDURE

The Invertec® V311-T AC/DC auto reconnects to 208V, 230V or 460V supply.

Fuse the input circuit with time delay fuses or delay type¹ circuit breakers. Using fuses or circuit breakers smaller than recommended may result in "nuisance" shut-offs from welder inrush currents even if not welding at high currents.

The Invertec® V311-T AC/DC is recommended for use on an individual branch circuit.

¹ Also called "inverse time" or "thermal/magnetic" circuit breakers. These circuit breakers have a delay in tripping action that decreases as the magnitude of the current increases.

INPUT PLUG INSTALLATION**POWER CORD CONNECTION**

A 10 ft. power cord is provided and wired into the machine. Follow the power cord connection instructions.

Single Phase Input

Connect green lead to ground per National Electrical Code.

Connect black and red leads to power.

Wrap white lead with tape to provide 600V insulation.

Three Phase Input

Connect green lead to ground per National Electric Code.

Connect black, red and white leads to power.

 **WARNING**

- **Failure to wire as instructed may cause personal injury or damage to equipment. To be installed or checked by an electrician or qualified person only.**

In all cases, the green or green/yellow grounding wire must be connected to the grounding pin of the plug, usually identified by a green screw.

Attachment plugs must comply with the Standard for Attachment Plugs and Receptacles, UL498.

The product is considered acceptable for use only when an attachment plug as specified is properly attached to the supply cord.

For use on engine drives, keep in mind the above input draw restrictions and the following precaution.

ENGINE DRIVEN GENERATOR

The Invertec® V311-T AC/DC TIG can be operated on engine driven generators as long as the 230 volt auxiliary meets the following conditions:

- The AC waveform peak voltage is below 400 volts.
- The AC waveform frequency is between 45 and 65Hz.

The following Lincoln engine drives meet these conditions when run in the high idle mode:

- Ranger 250, 305
- Vantage 300, 400, 500

Some engine drives do not meet these conditions (e.g. Miller Bobcats, etc). Operation of the Invertec® V311-T AC/DC is not recommended on engine drives not conforming to these conditions. Such drives may deliver unacceptably high voltage levels to the Invertec® V311-T AC/DC power source.

OUTPUT CONNECTIONS

⚠ WARNING



ELECTRIC SHOCK can kill.

- Insulate yourself from work and ground.
- Turn the input line Switch on the Invertec® V311T AC/DC “off” before connecting or disconnecting output cables or other equipment.

- Keep the electrode holder, TIG torch and cable insulation in good condition and in place.
- Do not touch electrically live parts or electrode with skin or wet clothing.

OUTPUT AND GAS CONNECTION FOR TIG WELDING (FIGURE A.1)

The TIG Torch Twist-Mate and work cable Twist-Mate Connectors are supplied with the welder. To connect the cables, turn the Power Switch “OFF”. Connect the torch cable Twist-Mate plug into the DC(-) Electrode/Gas Output Receptacle on the front of the welder and turn it clockwise until snug, (Do not Overtighten). This is a quick connect terminal and also provides the gas connection for the shielding gas to the torch.

⚠ WARNING

To avoid receiving a high frequency shock, keep the TIG torch and cable Insulation in good condition.

WORK CABLE CONNECTION

Next, connect the work cable to the “+” output terminal in the same way.

To minimize high frequency interference, refer to **Machine Grounding and High Frequency Interference Protection** section of this manual for the proper procedure on grounding the work clamp and work piece.

FIGURE A.1

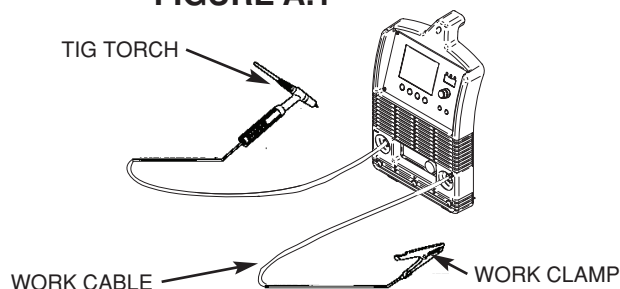

This unit does not include a TIG torch, but one may be purchased separately. The accessories section of this manual lists a number of Lincoln Electric TIG torches, and TIG Torch Starter Packs that are recommended for use with this machine; however, any similar TIG torch can be used. To attach the Twist-Mate Plug to a Lincoln Torch, slide the rubber boot onto the torch cable (enlarge the boot opening if necessary), screw the fitting on the torch cable into the brass connector snugly and slide the boot back over the brass connector.

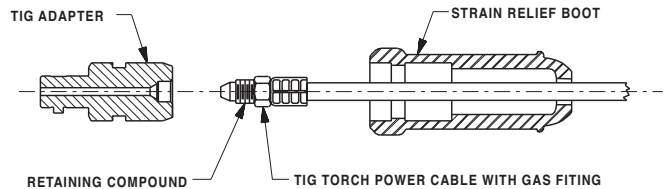

OUTPUT CONNECTION FOR STICK WELDING (FIGURE A.2)

First determine the proper electrode polarity for the electrode to be used. Consult the electrode data for this information. Then connect the output cables to the output terminals corresponding to this polarity. For instance, for DC(+) welding, connect the electrode cable (which is connected to the electrode holder) to the “+” output terminal and the work cable (which is connected to the work clamp) to the “-” output terminal. Insert the connector with the key lining up with the keyway, and rotate clockwise; until the connection is snug. Do not over tighten.

FIGURE A.2

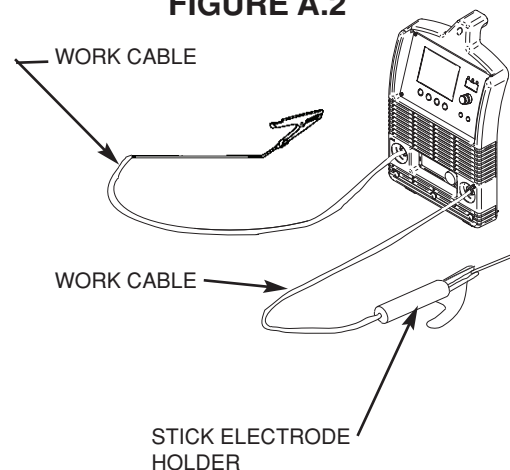

INVERTEC® V311-T AC/DC TIG



QUICK DISCONNECT PLUG (FOR STICK ELECTRODE CABLE and WORK CABLE)

A quick disconnect system is used for the welding cable connections. The stick electrode cable will need to have a plug attached.

1. Cut off welding cable lug, if present.
2. Remove 1.00 in. (25mm) of welding cable insulation.
3. Slide rubber boot onto cable end. The boot end may be trimmed to match the cable diameter. Use soap or other nonpetroleum-based lubricant to help slide the boot over the cable, if needed.

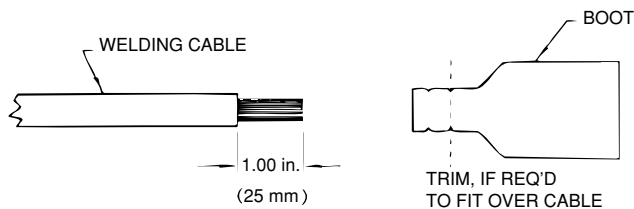

4. Insert copper strands into ferrule.

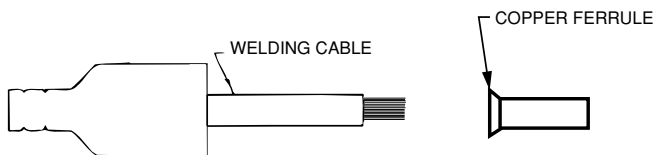

5. Slide the copper ferrule into the brass plug.
6. Tighten set screw to collapse copper tube. Screw must apply pressure against welding cable. The top of the set screw will be well below the surface of the brass plug after tightening.

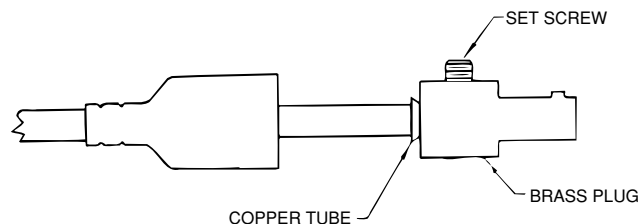

7. Slide rubber boot over brass plug. The rubber boot must be positioned to completely cover all electrical surfaces after the plug is locked into the receptacle.

SHIELDING GAS CONNECTION

Obtain the necessary inert shielding gas. Connect the cylinder of gas with a pressure regulator and flow gage. Install a gas hose between the regulator and gas inlet (located on the rear of the welder). The gas inlet has a 5/16-18 right hand female thread; CGA #032.

⚠ WARNING



CYLINDER could explode if damaged.

- Keep cylinder upright and chained to a support.

- Keep cylinder away from areas where it could be damaged.

- Never allow the torch or welding electrode to touch the cylinder.

- Keep cylinder away from live electrical circuits.

REMOTE CONTROL CONNECTION

A remote control receptacle is provided on the lower center case front of the welder for connecting a remote control to the machine. Refer to the Optional Accessories section of this manual for available remote controls.

Read and understand this entire section before operating your machine.

SAFETY INSTRUCTIONS

WARNING



ELECTRIC SHOCK can kill.

- Do not touch electrically live parts such as output terminals, electrode or internal wiring.
- Insulate yourself from the work and ground.
- Always wear dry insulating gloves.



FUMES AND GASES can be dangerous.

- Keep your head out of fumes.
- Use ventilation or exhaust to remove fumes from breathing zone.

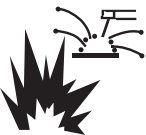

WELDING, CUTTING and GOUGING SPARKS can cause fire or explosion

- Keep flammable material away.
- Do not weld, cut or gouge on containers that have held combustibles.



ARC RAYS can burn.

- Wear eye, ear and body protection.

Only qualified personnel should operate this equipment. Observe all safety information throughout this manual.

GENERAL DESCRIPTION

The Invertec® V311-T AC/DC is an industrial 310 amp arc welding power source that utilizes single or three phase input power, to produce constant current output. The welding response has been optimized for stick (SMAW) and TIG (GTAW). The unit is ideal for industrial applications where portability, high efficiency and premium arc performance is important.

The Invertec® V311-T AC/DC is a power source that can perform the following types of welding with excellent results:

- TIG AC with square, sinusoidal and triangular waveforms.
- TIG DC (with high frequency or Touch Start TIG Starting)
- Stick DC & Stick AC

WELDING CAPABILITY

The Invertec® V311-T AC/DC is rated at 310 amps, 22.4 volts, at 40% duty cycle on a ten minute basis when connected to a 460V three phase supply line. It is capable of higher duty cycles at lower output currents. If the duty cycle is exceeded, a thermal protector will shut off the output until the machine cools. See Technical Specifications in A-1 for other rated outputs.

The Invertec® V311-T AC/DC is recommended for stick welding with such popular electrodes as Fleetweld 5P and 5P+ (E6010), Fleetweld 35 (E6011), Fleetweld 37 (E6013), Fleetweld 180 (E6011) and Excalibur 7018.

LIMITATIONS

The Invertec® V311-T AC/DC is not recommended for pipe thawing.

INVERTEC® V311-T AC/DC TIG



REAR CONTROL PANEL (FIGURE B.1)

⚠ WARNING

- **I1: Off/On switch turns on the electric power to the welder. It has two positions, "O" off, and "I" on.**

* With "I1" in the "I" (ON) position, the welding machine is operational and there is voltage between the positive (+) and negative (-) Terminals in stick welding. In TIG, the welding process needs a trigger closure command at the remote control connection. (Usually via an Arc Start Switch or Foot Amptrrol)

* The welder is connected to the supply even if the "I1" (Power Switch) is in the "O" (Off) position, and therefore there are electrically live parts inside the power source. Carefully follow the instructions given in this manual.

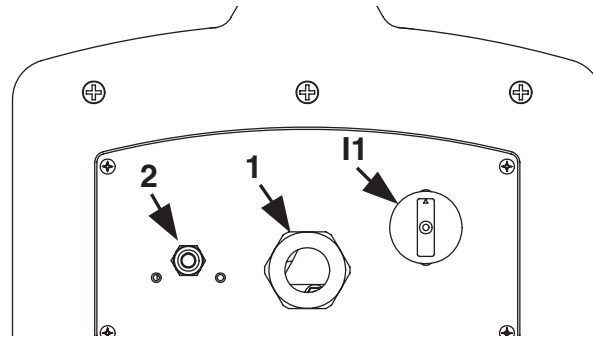

FIGURE B.1

- * 1 : Supply cable
- * 2 : Gas attachment
- I1 : Power Switch

LOWER CONTROL PANEL (FIGURE B.2)

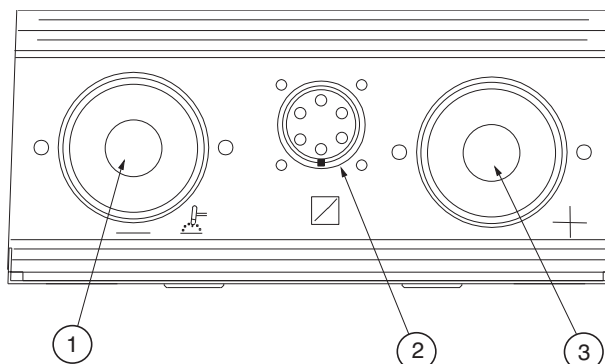

FIGURE B.2

- 1. Electrode Connection (Negative)** - For quick disconnect system using Twist-Mate cable plugs with gas pass through for TIG Torches.
- 2. Remote Control Connector** - For the connection of a Lincoln Foot Amptrrol, Hand Amptrrol or Arc Start Switch. See the ACCESSORIES section for available options.
- 3. Electrode Connection (Positive)** - For quick disconnect system using Twist-Mate cable plugs.

INVERTEC® V311-T AC/DC TIG



USER INTERFACE OVERVIEW AND OPERATION:

FIGURE B.3

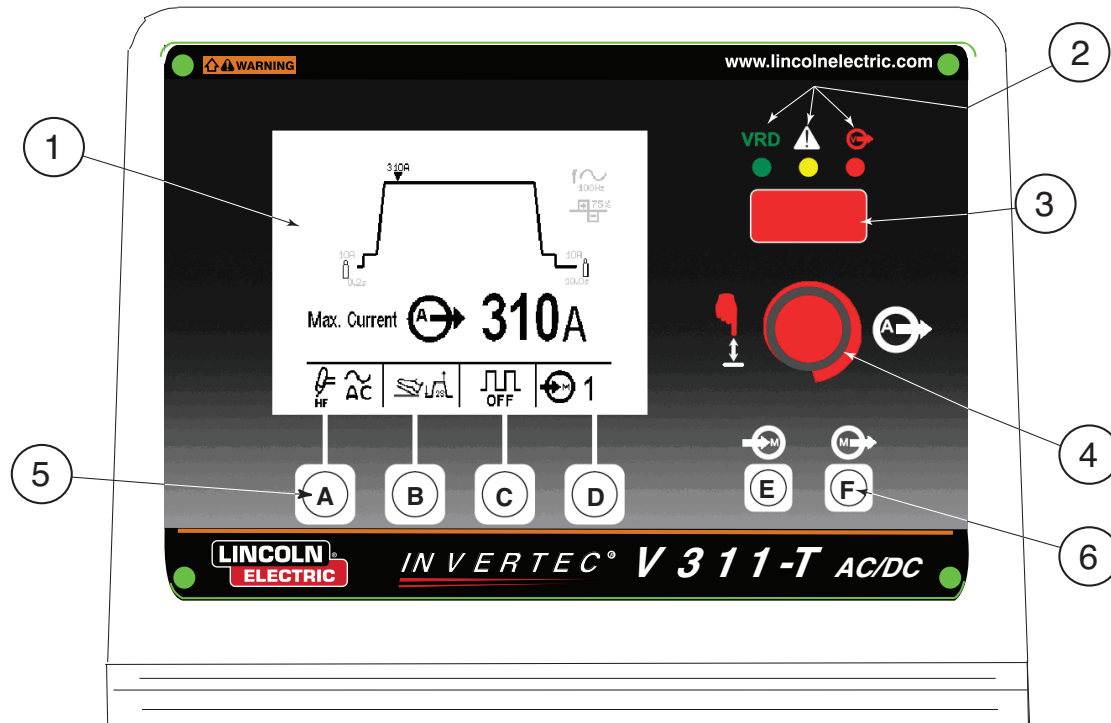

The Invertec® V311-T AC/DC User interface consists of the following (Refer to Figure B.3):

1. DYNAMIC LCD DISPLAY

2. STATUS LED LIGHTS

a. VRD On (Voltage Reduction Device)

Status Light- Voltage reduction device can be enabled from the set-up menu so that an output voltage limit can be set that reduces the output open circuit voltage to a safer level when not welding. If enabled when the machine is sitting idle in stick mode the Green VRD on light will illuminate to indicate the voltage is reduced below the set limit. If the VRD device is not enabled (factory default) from the set up menu or while welding the red VRD off light will illuminate to show that output voltage is present above the limit.

Note: The green VRD on light will illuminate in TIG mode until the output is triggered even when VRD is disabled. Also note that enabling VRD to reduce the output voltage can make striking a stick electrode more difficult.

b. General Alarm – Yellow LED which is lit when faults exist with the power source or optional cooler, such as over temperature, coolant blockage, etc.

c. Output On (No VRD) – This status light will illuminate red whenever the output is electrically hot and the voltage level is above the VRD threshold value.

3. A seven segment LED display (H)

4. PUSH BUTTON/ROTARY ENCODER

5. MODE PUSH BUTTONS (A-D)

- a. Weld Mode (A)
- b. Trigger Mode (B)
- c. TIG Pulse Mode (C)
- d. Memory Location Select (D)

6. PUSH BUTTONS (E, F)

- e. Memory Save (E)
- f. Memory Recall (F)

INVERTEC® V311-T AC/DC TIG



DYNAMIC LCD DISPLAY

The Dynamic display is divided into several sections (Refer to Figure B.4):

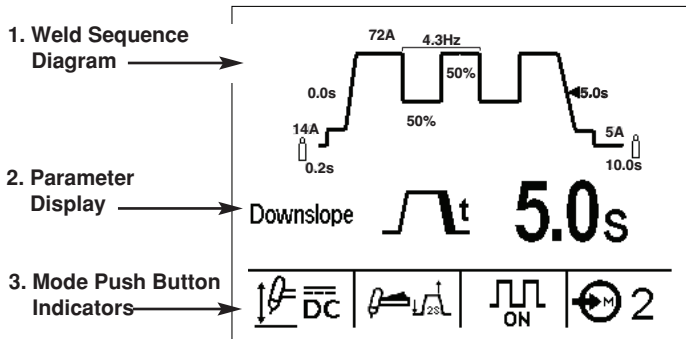

Figure B.4

1. The **Weld Sequence Diagram** shows the various parameters that can be selected and adjusted and their preset values. As the push button/rotary encoder is pressed a triangular shaped flashing indicator will highlight the adjustable parameter on the sequence diagram in bold. Each press of the encoder will scroll to the next selected parameter sequentially. Rotating the push button encoder will change the selected parameter value. The display is dynamic in that adjusting the selected parameter dynamically changes the shape of the sequence diagram. After 5 seconds of inactivity the selected parameter will default back to the weld output amps parameter. Depressing the button again will remember the last selected parameter and begin the sequential scroll from that parameter.

Three Sequence Diagram types exist:

- STICK (See Figure B.4a)
- TIG (See Figure B.4b)
- Pulse TIG (See Figure B.4c)

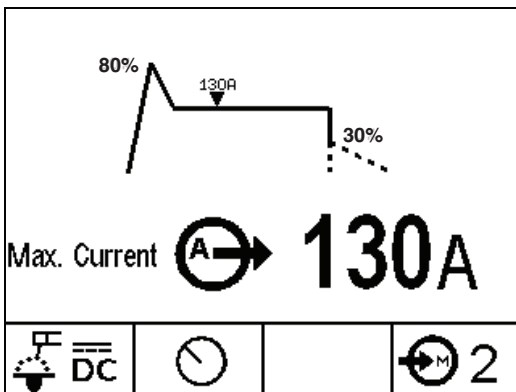

Figure B.4a

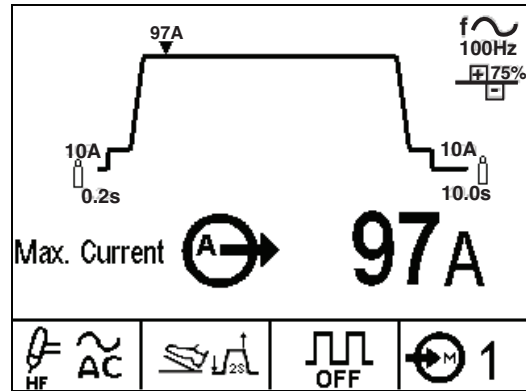

Figure B.4b

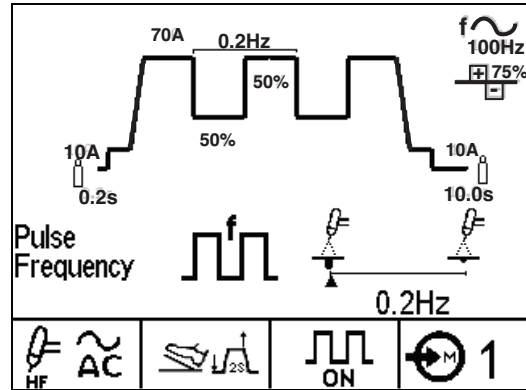

Figure B.4c

2. The **Parameter Display Section** shows the selected parameter its display icon and preset value. To change the value, rotate the push button/rotary encoder. Some parameters like AC Frequency have an Enhanced Icon Display that shows the effect of the varying parameter on the arc and/or weld bead profile. As these parameters are adjusted an indicator will move between the minimum and maximum icon to show the relative effect of that parameter. Pulse Frequency shown in Figure B.4c is an example of the enhanced icon display. Refer to Table B.1 for a list of Enhanced Icons.

PARAMETER	SYMBOL	
	MINIMUM	MAXIMUM
f~ AC FREQUENCY		
+□ AC BALANCE		
f□ PULSE FREQUENCY		
∇V HOT START		
∇ ARC FORCE		

Table B.1

3. The **Mode Push Buttons and Indicators** show the current selection made by the corresponding weld push buttons (A-F). Refer to Table B.2 for a full list of all parameters and their ranges. Below is a description of the function of each push button and display:



Two-Step with Foot Pedal - This mode is only available when the machine senses a remote amperage control device is plugged in. It is used when a foot or hand amptrol is plugged in. When this trigger mode is selected, upslope and downslope are set to zero and non-adjustable since the operator would manually adjust ramp up and ramp down of the welding current using the amptrol. The start and finish currents are linked together and are represented by a parameter called Minimum Current. (Refer to Figure B.5)





A. WELDING MODES	
	DC TIG - DC TIG welding with high frequency arc initiation.
	AC TIG - AC TIG welding with high frequency arc initiation.
	DC Touch Start TIG - DC TIG welding with lift tig arc initiation.
	Stick crisp mode - for Cellulosic electrodes like Exx10.
	Stick soft mode - for E7018 Low Hydrogen electrodes.
	AC Stick Mode - for AC Stick Electrodes.

Table B.2



Four Step - This mode is intended to be used with an arc start switch. It will not function properly in remote mode with a foot or hand amptrol plugged in. In four step operation depressing an arc start switch will cause the machine to initiate the arc at the start current level. When the switch is released the machine will ramp up to the maximum current over the upslope time. Depressing the arc start switch again causes the output to ramp down to the finish current level over the downslope time. Finally releasing the arc start switch causes the arc to go out. (Refer to Figure B.6)

B. TIG TRIGGER MODES

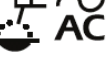
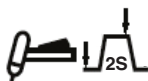

Two Step with Arc Start Switch - This mode is available in local or remote modes but is typically used with an arc start switch. Depressing the arc start switch will initiate the arc at the start current level and ramp up the output to the maximum current over the time set by the upslope time. Releasing the switch will cause the output amperage to ramp down to the finish current over the downslope time and then turn off the output. In this mode the start current and finish current can be independently set and upslope and downslope times are adjustable. (Refer to Figure B.5)

4 STEP DIAGRAM 1

4 STEP DIAGRAM

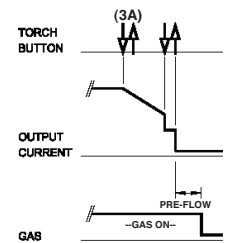
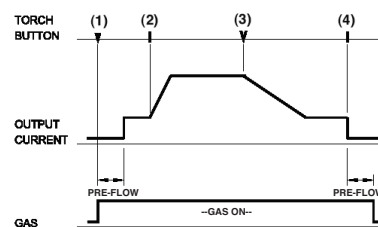

FIGURE B.6 4-STEP OPERATION SEQUENCE

2 STEP DIAGRAM 1

2 STEP DIAGRAM 2

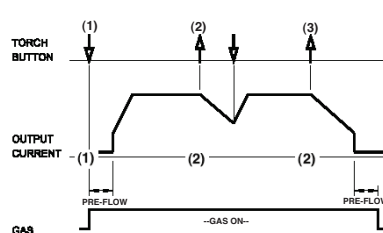
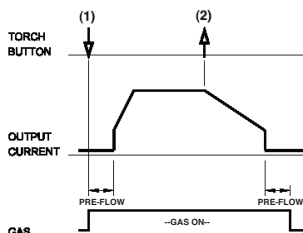

FIGURE B.5 2-STEP OPERATION SEQUENCE

INVERTEC® V311-T AC/DC TIG





Bi-Level Current – (If Enabled from the Setup Menu) Depressing an arc start switch and releasing will initiate the arc to current level A1. Depressing and releasing the arc Start switch again will toggle to current level A2. Each depressing and releasing of the switch will toggle between A1 and A2. Depressing and holding the switch in will initiate the down slope to the finish current level and finally releasing the trigger will extinguish the arc.



Spot Timer - (If Enabled from the Setup Menu) Selecting this trigger mode will enable a spot timer parameter setting to be displayed as a welding parameter. Once the arc is established the machine will weld for the time period set by the spot timer parameter setting. The machine will follow the functionality of two-step in that start current, up-slope, down-slope and finish current can all be adjusted.

STICK TRIGGER MODES



Local - In this mode the machine ignores any remote that is plugged. The machine will weld at the preset value set at the panel of the machine.



Remote - Allows the amperage to be set with a remote potentiometer.

C. TIG PULSE MODES



Pulse On - Turns on pulse welding in TIG mode. Changes the sequence diagram to Pulse TIG and allows the adjustment of the following added parameters:

- Pulse Frequency
- % Peak Time
- Background Current



Pulse Off - Turns off pulse welding in TIG.

D, E, & F. Memory Operation – Pressing and releasing the memory location (**D**) button will scroll through memory locations 1 through 10. When a memory is recalled or saved the memory location display will change to reversed text indicating that the current memory parameters are active.

Normal Display
(Unselected)



Reversed Display
(Selected)



Saving to Memory

- Press and hold Memory Save Button (**E**) until the memory location display indicator (**D**) changes to a reverse text indicating that the current parameters are the ones in the actively selected memory.

Recalling from Memory

- Press and hold the memory recall button (**F**) until the memory location display indicator (**D**) changes to reversed text indicating that the stored parameters are actively recalled.

When memory parameters are actively selected, the display indicator will remain reversed until a welding parameter is changed with the encoder knob or until the memory location button is pressed to scroll to a different memory location















Local/Remote Operation – The Invertec® V311-T AC/DC, when in TIG mode, will automatically sense when the machine has a remote device plugged into the 6 pin MS-type connector-like a remote pendant or a foot amptrol. If a remote device is plugged in, the machine will automatically function in remote mode. If no device is plugged in, the machine will function in local mode.

In remote mode, the operation of the machine is slightly different depending on whether the remote device is a foot amptrol or a remote pendant. To let the machine know what type of device is plugged in, the operator must select the appropriate device from the trigger mode button. (See Trigger mode descriptions above for details on the difference. In stick mode the second button on the control panel selects local or remote operation manually. This is required so that the user does not need to detach a foot amptrol to use the machine in STICK mode.

WELDING PARAMETERS

The following parameters are adjustable on the Invertec® V311-T AC/DC. (See Table B.3)

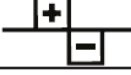
Table B.3

Parameter Symbol	Parameter Name	Parameter Range		
		unit	Min	Max
	Pre-Flow	Sec	0	5
	Start Current	Amps	Min.	Peak
	Finish Current	Amps	Min	Peak
	Min. Current	Amps	Min	Peak
	Upslope	Sec	0	10
	Downslope	Sec	0	10
	Spot Time	Sec	Off	10
	Max. Current	Amps	5	310
	Pulse Frequency	Hz	0.20	2500
	Background Current	%Amps	5%	95%
	% Peak Time	%	5	95
	Postflow	Sec	0	60
	AC Frequency	Hz	20	200
	AC Balance	% EN	35	85
	Hot Start	%	0	500
	Arc Force	%	0	500

USER MENU SET UP PARAMETERS

Many additional parameters can be modified via the Set Up Menu. To access the Set Up Menu press and hold the rotary encoder knob for several seconds until the following screen appears: (See figure B.7)

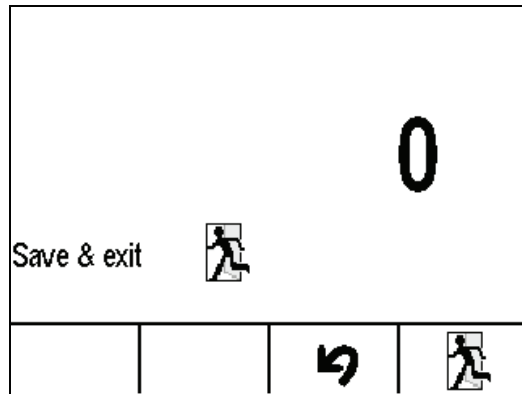

FIGURE B.7

Rotating the encoder knob will scroll through the setup parameters shown in Table B.4. Selected parameters are changed in one of two ways:

For parameters like background current (shown in Figure B.7a) the change is made by the mode push button. In this example you can toggle between setting background current as either a % or as absolute amperage. Other parameters like selectable wave shape (shown in Figure B.7b) are changed by depressing the encoder knob until the parameter is flashing. Rotating the knob changes the parameter and then the change is saved by pressing the encoder knob again. Once all changes are made you can exit and save by pressing the exit icon button or you can exit the set up menu without saving your changes by depressing the hooked arrow button.

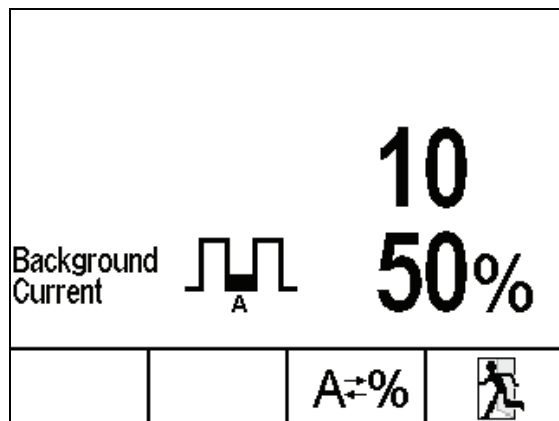

FIGURE B.7a

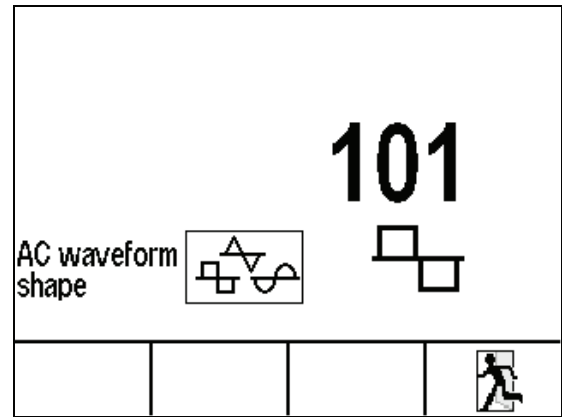



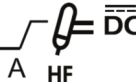
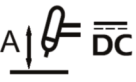
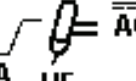

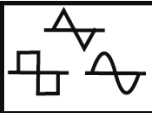





FIGURE B.7b



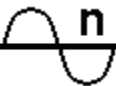

TABLE B.4 SET UP MENU PARAMETERS

Parameter Symbol	Selection/ * Default Value	Parameter Number	Description
See Figure B.7		0	Set Up menu Exit
0	NA	1	Reset All Parameters
	% * Amps	3	Start Current Set Unit
A2	% Amps*	8	Bi-Level Current 2 Set Unit
	% * Amps	10	Pulse Background Current Units
	% Amps*	17	Finish Current Set Unit
	15 amps*	307	DC TIG HF STRIKE CURRENT
	30 amps*	306	DC LIFT TIG STRIKE CURRENT
	30 amps*	307	AC TIG HF TIG STRIKE CURRENT
	Enabled* Disabled	214	2-Step trigger re-start
	Enabled Disabled*	215	4-Step trigger re-start
	Square* Sine Triangle	101	AC Waveform Shape
	Enabled Disabled *	998	Bi-Level Trigger
	Enabled Disabled *	999	Spot Timer Trigger
VRD	Off* Enabled to 12V Enabled to 20V Enabled to 30V	201	VRD Limit
		500	Not Used
	0 to 10 10*	552	Speaker Volume
	-20 to 20 10*	553	Display Contrast
	English* French Spanish	554	Display Language

INVERTEC® V311-T AC/DC TIG



TABLE B.4 (Continued) SET UP MENU PARAMETERS

Parameter Symbol	Selection/ * Default Value	Parameter Number	Description
	Display Off Display in 7 Segment LED Display*	751	Output Current Displayed
	Display Off* Display in 7 Segment LED Display	752	Output Voltage Displayed
	Display Off* Display in 7 Segment LED Display	753	Input Phase Displayed
	Display Off* Display in 7 Segment LED Display	754	Input Voltage Displayed
	<p>This function sets the initial start energy limit. Set this number to a higher setting than the factory default if needed to improve starting of large diameter tungsten electrodes.</p> <p>0.5 to 1.0 manual start energy setting. 1.2 to 5.0 = max. Incrementing limit. (See Note)</p> <p>Note: The machine will try to start the arc at a start power of 1. If the arc does not establish it will incrementally increase the start power and try to restrike up to the set limit.</p>	104	AC TIG Start Power (for AC TIG only)

OPTIONAL COOL-ARC 35 WATER COOLER

The optional Cool-Arc 35 water cooler is designed to operate in communication with the Invertec® V311-T AC/DC. Refer to the Cool-Arc 35 operator manual for installation instructions and a complete description of its operation.

When the Invertec® V311-T AC/DC is powered ON the Cool-Arc 35 will automatically power ON as well. The Cool-Arc 35 monitors pressure and temperature and will adjust the pump speed accordingly to cool the torch. If a blockage of coolant or loss of coolant is sensed both the Cool-Arc 35 and Invertec® V311-T AC/DC will display an error and turn off the Invertec® V311-T AC/DC's output.

IMPORTANT: If the Cool-Arc 35 water cooler is connected to the Invertec® V311-T AC/DC and an air cooled torch is connected instead of a water cooled torch the Cool-Arc 35 will sense a coolant blockage resulting in a cooler error.

In this case the cooler can be turned to the "off mode" by depressing and holding the push button on the cooler until the cooler's display reads "oo". To turn the cooler back on you can depress and hold the Cool-Arc 35 push button until the cooler's digital display reads coolant temperature in degrees Celsius. Turning the Invertec® V311-T AC/DC off and on again will automatically turn the water cooler back on as well.

INVERTEC® V311-T AC/DC TIG



TIPS FOR IMPROVED TIG STARTING

1. Start Current:



For the best AC or DC TIG starting characteristics it may be necessary to adjust the start current on the front panel depending on the tungsten size. In general, larger tungsten requires more energy to establish an arc than smaller tungsten. As an initial guideline, set the start current according to the following recommendations:

Tungsten Size (in.)	Start Current (Amps)
0.020, 0.040 1/16th	6-10 Amps
3/32 th	10-12 Amps
1/8th	12-15 Amps

2. DC Strike Current:



Aside from start current, DC strike current can also be adjusted from the set-up menu to get a hotter or softer start when DC TIG welding. Strike current is an initial spike of current that lasts a few milliseconds before the machine goes to start current. In general, the factory default of 15 amps works for most applications. If welding on very thin materials with small diameter tungsten, strike current can be turned down to minimize burning through the weld material. Like-wise for larger diameter tungsten strike current can be turned up to put more energy in the tungsten.

3. AC TIG Start Power:



For AC TIG welding AC start power can be adjusted from the set-up menu to aid starting if required. The Invertec® V311-T AC/DC when set to AC TIG will try to initiate the arc with positive polarity until the arc is established. Positive polarity puts more energy into heating the tungsten but the drawback is that it can cause the tungsten to ball excessively or to super heat. Note super heating of the tungsten can be noticed if the tungsten is glowing red or orange during starting. Start Power can be adjusted within two ranges:

Range	Mode
0.5 to 1	Manual Setting
1.2 to 5.0	Incremental setting

If start power is set within the incremental range mode, the machine tries to start electrode positive at a relative setting of 1. If the arc fails to establish it will repeat the start sequence each time by incrementing the amount of electrode positive energy by 10% (0.1) up to the start power limit setting or until the arc establishes. For comparison a start power limit of 2 if reached will have twice the energy of the starting point of 1. If the tungsten has too much of a ball on it or appears to be super heating during starts the start power limit can be turned down. In the manual setting range, the start power will not keep incrementing up to a limit. Instead the start power stays at whatever level is set. For example a setting of 0.5 will start the machine with half the normal starting energy of 1.

STICK CRISP MODE DYNAMIC CURRENT REGULATION

When running E6010 electrodes DC Crisp mode is recommended. The Invertec® V311-T AC/DC has a special dynamic current regulation that is ideal for the whipping technique common to E6010 electrodes. The machine regulates the welding current based on changes in arc length. As the arc length is increased and the arc voltage increases, the machine will reduce its welding current below the set point. As the arc length is decreased and the arc voltage decreases the machine will increase its current.

FIGURE B.8

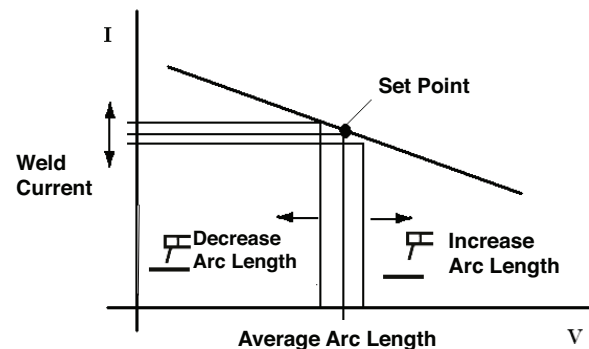

Arc Force Control – Arc Force is a setting that helps reduce sticking the electrode into the weld puddle. Increasing the arc force percentage will provide a higher boost of current when the electrode is about to short into the weld puddle. In Stick Crisp mode since the current is dynamically regulated based on the arc voltage, shorting the electrode to the work will be rare - therefore, adjustments to the arc force percentage will not be as noticeable in Stick Crisp mode compared to Stick Soft mode.

OPTIONAL ACCESSORIES AND COMPATIBLE EQUIPMENT

Field Installed

K857 - Remote Output Control - For Stick welding. Portable current control provides the same range as the current control on the welder. Consists of a 6-pin connector which plugs into the remote control connector. 25 foot cable length.

K870 - Foot Amptrol™ for TIG welding. The foot Amptrol energizes the output and controls the output remotely. The Foot Amptrol connects directly to the 6-pin remote control connector.

K963-3 - Hand Amptrol™ for TIG welding. The hand Amptrol energizes the output and controls the output remotely. The Hand Amptrol connects directly to the 6-pin remote control connector.

K814 - Arc Start Switch - Energizes the output for TIG welding if remote output control of the amperage is not desired. It allows on/off TIG welding at the amperage set by the Current Control on the control panel. When using the Arc Start Switch set the Output Control to the "LOCAL" position.

K2630-1 - Cool-Arc® 35 Water Cooler- Attaches underneath the Invertec® V311-T AC/DC and electrically connects to the Invertec® V311-T AC/DC. This smart cooler varies its speed based on coolant temperature and monitors coolant pressure.

K2694-1 Inverter Cart- Conveniently holds the Cool-Arc 35 and Invertec® V311-T AC/DC power source. Features a tool storage tray for convenience and a cylinder platform to hold a gas bottle

TIG TORCH STARTER KITS

K2266-1 – TIG-Mate 17 Air Cooled TIG Torch Starter Pack. One complete easy-to-order kit packaged in its own portable carrying case. Includes: PTA-17 torch, parts kit, Harris flowmeter/regulator, 10 ft. gas hose, Twist-Mate™ adapter, work clamp and cable.

K2267-1 – TIG-Mate 20 Water-Cooled TIG Torch Starter Pack. One complete easy-to-order kit packaged in its own portable carrying case. Includes: PTW-20 torch, parts kit, Harris flowmeter/regulator, 10 ft. gas hose, Twist-Mate™ adapter, work clamp and cable, and 10 ft. water hose.

Magnum® TIG Torches – The following standard Magnum® TIG torches may be used with the Invertec® V311-T AC/DC for Lincoln's full line of TIG torches including flex head models consult publication E12.150.

- K1781-1 PTA-9 12.5 ft.(3.8m) Air-Cooled 125A
- K1781-3 PTA-9 25 ft.(7.6m) Air-Cooled 125A
- K1782-1 PTA-17 12.5 ft.(3.8m) Air-Cooled 150A
- K1782-3 PTA-17 25 ft.(7.6m) Air-Cooled 150A
- K1783-1 PTA-26 12.5 ft.(3.8m) Air-Cooled 200A
- K1783-3 PTA-26 25 ft.(7.6m) Air-Cooled 200A
- K1784-3 PTW-20 12.5 ft.(3.8m) Water-Cooled 250A
- K1784-4 PTW-20 25 ft.(7.6m) Water-Cooled 250A
- K1784-1 PTW-18 12.5 ft.(3.8m) Water-Cooled 350A
- K1784-2 PTW-18 25 ft.(7.6m) Water-Cooled 350A

NOTE: Each torch requires a Twist-Mate™ adapter, collets, collet bodies, and nozzles and are not included and must be ordered separately.

CABLE PLUGS

K852-70 - Cable Plug Kit for 1/0-2/0 cable. Attaches to welding cable to provide quick disconnect from machine.

K1622-1 Twist-Mate adapter for PTA-9 & 17 Air-Cooled TIG torches – Adapter for PTA-9 or PTA-17 TIG torches with one-piece cable. The quick connect plug provides connection for both gas and welding current.

K1622-3 Twist-Mate adapter for PTA-26 Air-Cooled TIG torches – Adapter for PTA-26 TIG torches with one-piece cable. The quick connect plug provides connection for both gas and welding current.

K1622-4 – Twist-Mate adapter for Water-Cooled TIG torches. Adapter for PTW-18 and -20 Torches.

TIG Torch Parts Kits - Parts kits are available for the TIG torches. These kits include back cap, collets, collet bodies, nozzles and tungstens.

Order KP510 for PTW-20 Water-cooled torches

Order KP507 for PTA-9 torches

Order KP508 for PTA-17 torches

Order KP509 for PTA-26 & PTW-18 torches

Order KP2414-1 Gas Lens Parts kit for PTA-9 torches

See publication E12.150 for parts kits breakdown.

Cut Length Consumables - TIG welding filler metals are available for welding stainless steel, mild steel, aluminum and copper alloys. See publication C9.10.

SAFETY PRECAUTIONS

⚠ WARNING



ELECTRIC SHOCK can kill.

- Have an electrician install and service this equipment.
- Turn the input power off at the fuse box, disconnect or unplug supply lines and allow machine to sit for five minutes minimum to allow the power capacitors to discharge before working inside this equipment.
- Do not touch electrically hot parts.

INPUT FILTER CAPACITOR DISCHARGE PROCEDURE

⚠ WARNING

The machine has internal capacitors which are charged to a high voltage during power-on conditions. This voltage is dangerous and must be discharged before the machine can be serviced. Discharging is done automatically by the machine each time the power is switched off. However, you must allow the machine to sit for at least 5 minutes to allow time for the process to take place.

ROUTINE MAINTENANCE

Prevent metal powder from accumulating near the aeration fins and over them.

Carry out the following periodic controls on the power source:

- Clean the power source inside by means of low-pressure compressed air.
- Check the electric connections and all the connection cables.
- Always use gloves in compliance with the safety standards.

HOW TO USE TROUBLESHOOTING GUIDE

WARNING

Service and Repair should only be performed by Lincoln Electric Factory Trained Personnel. Unauthorized repairs performed on this equipment may result in danger to the technician and machine operator and will invalidate your factory warranty. For your safety and to avoid Electrical Shock, please observe all safety notes and precautions detailed throughout this manual.

This Troubleshooting Guide is provided to help you locate and repair possible machine malfunctions. Simply follow the three-step procedure listed below.

Step 1. LOCATE PROBLEM (SYMPTOM).

Look under the column labeled "PROBLEM (SYMPTOMS)". This column describes possible symptoms that the machine may exhibit. Find the listing that best describes the symptom that the machine is exhibiting.

Step 2. POSSIBLE CAUSE.

The second column labeled "POSSIBLE CAUSE" lists the obvious external possibilities that may contribute to the machine symptom.

Step 3. RECOMMENDED COURSE OF ACTION

This column provides a course of action for the Possible Cause, generally it states to contact your local Lincoln Authorized Field Service Facility.

If you do not understand or are unable to perform the Recommended Course of Action safely, contact your local Lincoln Authorized Field Service Facility.

CAUTION

If for any reason you do not understand the test procedures or are unable to perform the tests/repairs safely, contact your **Local Lincoln Authorized Field Service Facility** for technical troubleshooting assistance before you proceed.

INVERTEC® V311-T AC/DC TIG



Observe all Safety Guidelines detailed throughout this manual

PROBLEMS (SYMPTOMS)	POSSIBLE CAUSE	RECOMMENDED COURSE OF ACTION
PROBLEMS IN STICK WELDING		
Excessive spatter	<ol style="list-style-type: none"> 1. Long arc 2. High current 	<p>If all recommended possible areas of misadjustment have been checked and the problem persists, Contact your local Lincoln Authorized Field Service Facility.</p>
Craters	<ol style="list-style-type: none"> 1. Fast movement of the electrode away from piece. 	
Inclusions	<ol style="list-style-type: none"> 1. Poor cleanliness or distribution of the Welding passes. 2. Improper movement of the electrode. 	
Insufficient penetration	<ol style="list-style-type: none"> 1. High progression speed. 2. Welding current too low. 3. Narrow chamfering. 	
Sticking	<ol style="list-style-type: none"> 1. Arc too short. 2. Current too low. 	
Porosity	<ol style="list-style-type: none"> 1. Humidity in electrode. 2. Long arc. 	
Cracks	<ol style="list-style-type: none"> 1. Current too high. 2. Dirty materials. 3. Hydrogen in weld (present on electrode coating). 	

⚠ CAUTION

If for any reason you do not understand the test procedures or are unable to perform the tests/repairs safely, contact your **Local Lincoln Authorized Field Service Facility** for technical troubleshooting assistance before you proceed.

INVERTEC® V311-T AC/DC TIG



Observe all Safety Guidelines detailed throughout this manual

PROBLEMS (SYMPTOMS)	POSSIBLE CAUSE	RECOMMENDED COURSE OF ACTION
PROBLEMS IN TIG WELDING		
Oxidation	<ol style="list-style-type: none"> 1. Insufficient gas. 2. No protection on the back side. 	<p>If all recommended possible areas of misadjustment have been checked and the problem persists, Contact your local Lincoln Authorized Field Service Facility.</p>
Tungsten inclusions	<ol style="list-style-type: none"> 1. Incorrect electrode sharpening. 2. Electrode too small. 3. Operating failure (contact of the tip with the workpiece). 	
Porosity	<ol style="list-style-type: none"> 1. Dirt on the edges. 2. Dirt on the filler material. 3. Excessive travel speed. 4. Current intensity too low. 5. Insufficient gas flow rate 	
Hot cracking	<ol style="list-style-type: none"> 1. Unsuitable filler material. 2. High heat supply. 3. Dirty materials. 	

⚠ CAUTION

If for any reason you do not understand the test procedures or are unable to perform the tests/repairs safely, contact your **Local Lincoln Authorized Field Service Facility** for technical troubleshooting assistance before you proceed.

INVERTEC® V311-T AC/DC TIG



Observe all Safety Guidelines detailed throughout this manual

PROBLEMS (SYMPTOMS)	POSSIBLE CAUSE	RECOMMENDED COURSE OF ACTION
ELECTRICAL FAILURES		
Machine fails to come on (LCD screen and LED display do not illuminate)	<ol style="list-style-type: none"> 1. No Input Voltage. 2. Faulty supply plug or cable. 3. Internal fuse blown. 4. Input voltage not within range 	<p>If all recommended possible areas of misadjustment have been checked and the problem persists, Contact your local Lincoln Authorized Field Service Facility.</p>
Power output incorrect	<ol style="list-style-type: none"> 1. Incorrect setting up of the welding parameters. 2. Low mains supply voltage 	
No output current	<ol style="list-style-type: none"> 1. E01, E02, E03 DISPLAYED, and the yellow control panel LED on. <ul style="list-style-type: none"> • Equipment Overheat. Allow machine to cool. The power should remain on so the fan can maintain airflow and cool the machine 2. E38 DISPLAYED• Input supply voltage dipped low. 3. E39, E40 DISPLAYED <ul style="list-style-type: none"> • Input supply voltage out of range or loss of phase . 4. E14, E15, or E18 DISPLAYED <ul style="list-style-type: none"> • Internal memory errors. (Contact your local Lincoln Electric Authorized Service Facility.) 	

⚠ CAUTION

If for any reason you do not understand the test procedures or are unable to perform the tests/repairs safely, contact your **Local Lincoln Authorized Field Service Facility** for technical troubleshooting assistance before you proceed.

INVERTEC® V311-T AC/DC TIG



The Invertec® V311-T AC/DC, when a fault condition is detected, displays on the graphics LCD an alarm notification composed of:

ALARM ICON + ALARM CODE + ALARM TYPE ICON



Exx



When a fault condition is detected, the power source and the cooler are switched in safety mode, it means the welding operation are stopped. To recover from a fault condition, it is necessary to remove the cause and exit the safety mode depressing the exit key button on the UI.

ALARM ID CODES:

E01, E02, E03		Temperature alarm
E10		Boost/Inverter overcurrent
E11, E19		System configuration alarm
E14, E15, E18		Program not valid alarm
E17		Communication alarm (µP-DSP)-Type 1
E20		Memory fault alarm
E21		Data loss alarm
E22		Communication alarm (µP-DSP)-Type 2
E27		Memory_1 fault alarm
E28		Memory_2 fault alarm
E29		Output power alarm
E38		Under voltage alarm
E39,E40		System power supply alarm
E43		Coolant shortage – clogged pipe alarm
E44		Coolant temperature alarm
E99		General alarm

INVERTEC® V311-T AC/DC TIG



WIRING DIAGRAM

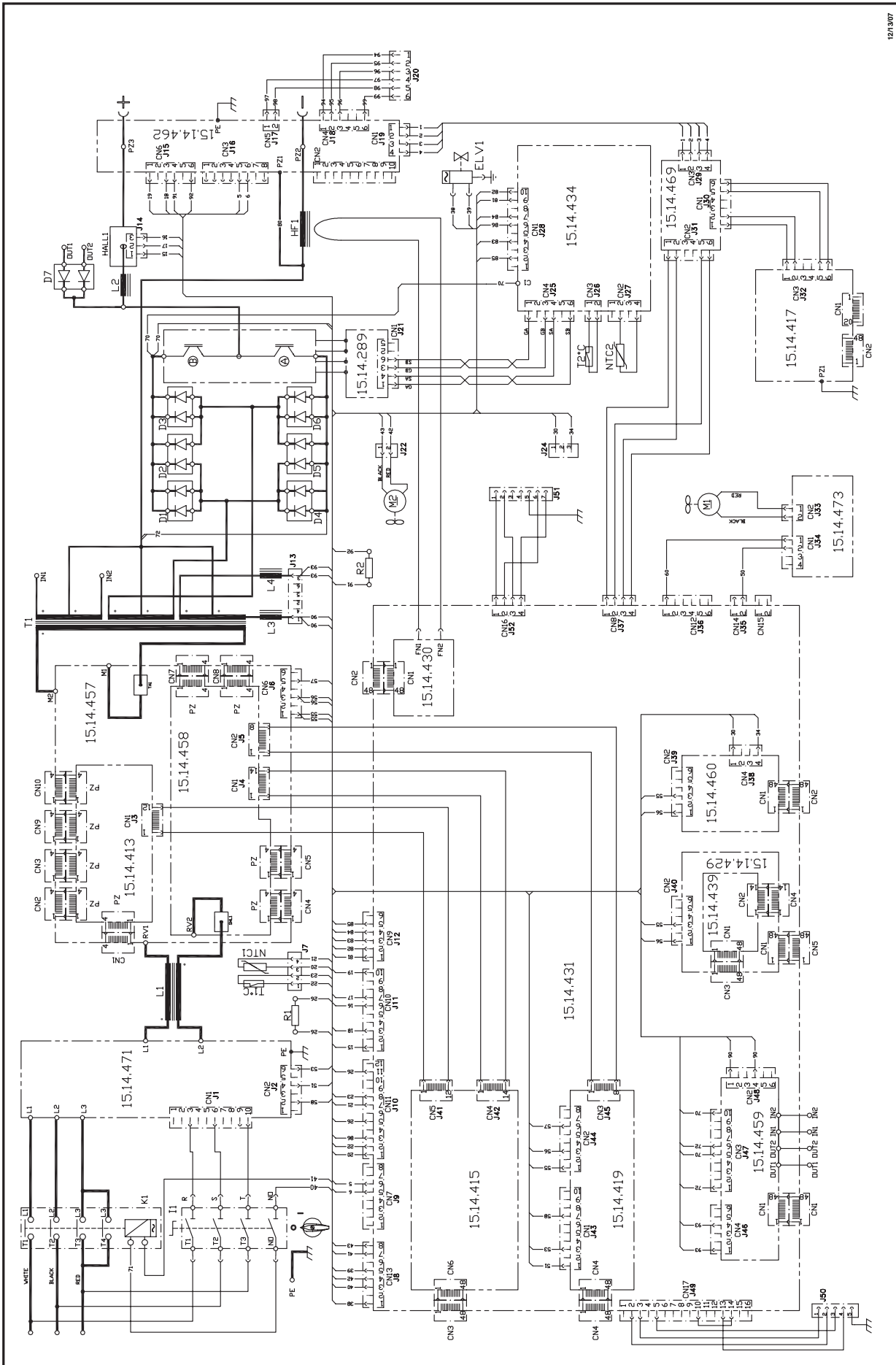

1274307

NOTE: This diagram is for reference only. It may not be accurate for all machines covered by this manual. The specific diagram for a particular code is pasted inside the machine on one of the enclosure panels. If the diagram is illegible, write to the Service Department for a replacement. Give the equipment code number.

INVERTEC® V311-T AC/DC TIG



			
WARNING	<ul style="list-style-type: none"> Do not touch electrically live parts or electrode with skin or wet clothing. Insulate yourself from work and ground. 	<ul style="list-style-type: none"> Keep flammable materials away. 	<ul style="list-style-type: none"> Wear eye, ear and body protection.
Spanish AVISO DE PRECAUCION	<ul style="list-style-type: none"> No toque las partes o los electrodos bajo carga con la piel o ropa mojada. Aíslese del trabajo y de la tierra. 	<ul style="list-style-type: none"> Mantenga el material combustible fuera del área de trabajo. 	<ul style="list-style-type: none"> Protéjase los ojos, los oídos y el cuerpo.
French ATTENTION	<ul style="list-style-type: none"> Ne laissez ni la peau ni des vêtements mouillés entrer en contact avec des pièces sous tension. Isolez-vous du travail et de la terre. 	<ul style="list-style-type: none"> Gardez à l'écart de tout matériel inflammable. 	<ul style="list-style-type: none"> Protégez vos yeux, vos oreilles et votre corps.
German WARNUNG	<ul style="list-style-type: none"> Berühren Sie keine stromführenden Teile oder Elektroden mit Ihrem Körper oder feuchter Kleidung! Isolieren Sie sich von den Elektroden und dem Erdboden! 	<ul style="list-style-type: none"> Entfernen Sie brennbares Material! 	<ul style="list-style-type: none"> Tragen Sie Augen-, Ohren- und Körperschutz!
Portuguese ATENÇÃO	<ul style="list-style-type: none"> Não toque partes elétricas e electrodos com a pele ou roupa molhada. Isole-se da peça e terra. 	<ul style="list-style-type: none"> Mantenha inflamáveis bem guardados. 	<ul style="list-style-type: none"> Use proteção para a vista, ouvido e corpo.
Japanese 注意事項	<ul style="list-style-type: none"> 通電中の電気部品、又は溶材にヒフやぬれた布で触れないこと。 施工物やアースから身体が絶縁されている様にして下さい。 	<ul style="list-style-type: none"> 燃えやすいものの側での溶接作業は絶対にしてはなりません。 	<ul style="list-style-type: none"> 目、耳及び身体に保護具をして下さい。
Chinese 警告	<ul style="list-style-type: none"> 皮肤或湿衣物切勿接触带电部件及焊条。 使你自已与地面和工作件绝缘。 	<ul style="list-style-type: none"> 把一切易燃物品移离工作场所。 	<ul style="list-style-type: none"> 佩戴眼、耳及身体劳动保护用具。
Korean 위험	<ul style="list-style-type: none"> 전도체나 용접봉을 젖은 헝겍 또는 피부로 절대 접촉치 마십시오. 모재와 접지를 접촉치 마십시오. 	<ul style="list-style-type: none"> 인화성 물질을 접근시키지 마십시오. 	<ul style="list-style-type: none"> 눈, 귀와 몸에 보호장구를 착용하십시오.
Arabic تحذير	<ul style="list-style-type: none"> لا تلمس الاجزاء التي يسري فيها التيار الكهربائي أو الألكترود بجسد الجسم أو بالملابس المبللة بالماء. ضع عازلا على جسمك خلال العمل. 	<ul style="list-style-type: none"> ضع المواد القابلة للاشتعال في مكان بعيد. 	<ul style="list-style-type: none"> ضع أدوات وملابس واقية على عينيك وأذنيك وجسمك.

READ AND UNDERSTAND THE MANUFACTURER'S INSTRUCTION FOR THIS EQUIPMENT AND THE CONSUMABLES TO BE USED AND FOLLOW YOUR EMPLOYER'S SAFETY PRACTICES.

SE RECOMIENDA LEER Y ENTENDER LAS INSTRUCCIONES DEL FABRICANTE PARA EL USO DE ESTE EQUIPO Y LOS CONSUMIBLES QUE VA A UTILIZAR, SIGA LAS MEDIDAS DE SEGURIDAD DE SU SUPERVISOR.

LISEZ ET COMPRENEZ LES INSTRUCTIONS DU FABRICANT EN CE QUI REGARDE CET EQUIPMENT ET LES PRODUITS A ETRE EMPLOYES ET SUIVEZ LES PROCEDURES DE SECURITE DE VOTRE EMPLOYEUR.

LESEN SIE UND BEFOLGEN SIE DIE BETRIEBSANLEITUNG DER ANLAGE UND DEN ELEKTRODENEINSATZ DES HERSTELLERS. DIE UNFALLVERHÜTUNGSVORSCHRIFTEN DES ARBEITGEBERS SIND EBENFALLS ZU BEACHTEN.

			
<ul style="list-style-type: none"> ● Keep your head out of fumes. ● Use ventilation or exhaust to remove fumes from breathing zone. 	<ul style="list-style-type: none"> ● Turn power off before servicing. 	<ul style="list-style-type: none"> ● Do not operate with panel open or guards off. 	WARNING
<ul style="list-style-type: none"> ● Los humos fuera de la zona de respiración. ● Mantenga la cabeza fuera de los humos. Utilice ventilación o aspiración para gases. 	<ul style="list-style-type: none"> ● Desconectar el cable de alimentación de poder de la máquina antes de iniciar cualquier servicio. 	<ul style="list-style-type: none"> ● No operar con panel abierto o guardas quitadas. 	Spanish AVISO DE PRECAUCION
<ul style="list-style-type: none"> ● Gardez la tête à l'écart des fumées. ● Utilisez un ventilateur ou un aspirateur pour ôter les fumées des zones de travail. 	<ul style="list-style-type: none"> ● Débranchez le courant avant l'entretien. 	<ul style="list-style-type: none"> ● N'opérez pas avec les panneaux ouverts ou avec les dispositifs de protection enlevés. 	French ATTENTION
<ul style="list-style-type: none"> ● Vermeiden Sie das Einatmen von Schweißrauch! ● Sorgen Sie für gute Be- und Entlüftung des Arbeitsplatzes! 	<ul style="list-style-type: none"> ● Strom vor Wartungsarbeiten abschalten! (Netzstrom völlig öffnen; Maschine anhalten!) 	<ul style="list-style-type: none"> ● Anlage nie ohne Schutzgehäuse oder Innenschutzverkleidung in Betrieb setzen! 	German WARNUNG
<ul style="list-style-type: none"> ● Mantenha seu rosto da fumaça. ● Use ventilação e exaustão para remover fumo da zona respiratória. 	<ul style="list-style-type: none"> ● Não opere com as tampas removidas. ● Desligue a corrente antes de fazer serviço. ● Não toque as partes elétricas nuas. 	<ul style="list-style-type: none"> ● Mantenha-se afastado das partes moventes. ● Não opere com os painéis abertos ou guardas removidas. 	Portuguese ATENÇÃO
<ul style="list-style-type: none"> ● ヒュームから頭を離すようにして下さい。 ● 換気や排煙に十分留意して下さい。 	<ul style="list-style-type: none"> ● メンテナンス・サービスに取りかかる際には、まず電源スイッチを必ず切して下さい。 	<ul style="list-style-type: none"> ● パネルやカバーを取り外したまま機械操作をしないで下さい。 	Japanese 注意事項
<ul style="list-style-type: none"> ● 頭部遠離煙霧。 ● 在呼吸區使用通風或排風器除煙。 	<ul style="list-style-type: none"> ● 維修前切斷電源。 	<ul style="list-style-type: none"> ● 儀表板打開或沒有安全罩時不準作業。 	Chinese 警告
<ul style="list-style-type: none"> ● 얼굴로부터 용접가스를 멀리하십시오. ● 호흡지역으로부터 용접가스를 제거하기 위해 가스제거기나 통풍기를 사용하십시오. 	<ul style="list-style-type: none"> ● 보수전에 전원을 차단하십시오. 	<ul style="list-style-type: none"> ● 판넬이 열린 상태로 작동치 마십시오. 	Korean 위험
<ul style="list-style-type: none"> ● ابعِد رأسك بعيداً عن الدخان. ● استعمل التهوية أو جهاز ضغط الدخان للخارج لكي تبعد الدخان عن المنطقة التي تتنفس فيها. 	<ul style="list-style-type: none"> ● اقطع التيار الكهربائي قبل القيام بأية صيانة. 	<ul style="list-style-type: none"> ● لا تشغيل هذا الجهاز اذا كانت الاغطية الحديدية الواقية ليست عليه. 	Arabic تحذير

LEIA E COMPREENDA AS INSTRUÇÕES DO FABRICANTE PARA ESTE EQUIPAMENTO E AS PARTES DE USO, E SIGA AS PRÁTICAS DE SEGURANÇA DO EMPREGADOR.

使う機械や溶材のメーカーの指示書をよく読み、まず理解して下さい。そして貴社の安全規定に従って下さい。

請詳細閱讀並理解製造廠提供的說明以及應該使用的銀焊材料，並請遵守貴方的有閣勞動保護規定。

이 제품에 동봉된 작업지침서를 숙지하시고 귀사의 작업자 안전수칙을 준수하시기 바랍니다.

اقرأ بتمعن وافهم تعليمات المصنع المنتج لهذه المعدات والمواد قبل استعمالها واتبع تعليمات الوقاية لصاحب العمل.



• World's Leader in Welding and Cutting Products •

• Sales and Service through Subsidiaries and Distributors Worldwide •

Cleveland, Ohio 44117-1199 U.S.A. TEL: 216.481.8100 FAX: 216.486.1751 WEB SITE: www.lincolnelectric.com

Download from Www.Somanuals.com. All Manuals Search And Download.

Free Manuals Download Website

<http://myh66.com>

<http://usermanuals.us>

<http://www.somanuals.com>

<http://www.4manuals.cc>

<http://www.manual-lib.com>

<http://www.404manual.com>

<http://www.luxmanual.com>

<http://aubethermostatmanual.com>

Golf course search by state

<http://golfingnear.com>

Email search by domain

<http://emailbydomain.com>

Auto manuals search

<http://auto.somanuals.com>

TV manuals search

<http://tv.somanuals.com>