

CV500-I

For use with machines Codes 10088 thru 10092, 10277, 10278, 11356

Safety Depends on You

Lincoln arc welding and cutting equipment is designed and built with safety in mind. However, your overall safety can be increased by proper installation ... and thoughtful operation on your part. **DO NOT INSTALL, OPERATE OR REPAIR THIS EQUIPMENT WITHOUT READING THIS MANUAL AND THE SAFETY PRECAUTIONS CONTAINED THROUGHOUT.** And, most importantly, think before you act and be careful.



OPERATOR'S MANUAL



LINCOLN[®]
ELECTRIC

Copyright © Lincoln Global Inc.

• World's Leader in Welding and Cutting Products •

• Sales and Service through Subsidiaries and Distributors Worldwide •

Cleveland, Ohio 44117-1199 U.S.A. TEL: 216.481.8100 FAX: 216.486.1751 WEB SITE: www.lincolnelectric.com

Download from Www.Somanuals.com. All Manuals Search And Download.

WARNING



CALIFORNIA PROPOSITION 65 WARNINGS



Diesel engine exhaust and some of its constituents are known to the State of California to cause cancer, birth defects, and other reproductive harm.

The Above For Diesel Engines

The engine exhaust from this product contains chemicals known to the State of California to cause cancer, birth defects, or other reproductive harm.

The Above For Gasoline Engines

ARC WELDING CAN BE HAZARDOUS. PROTECT YOURSELF AND OTHERS FROM POSSIBLE SERIOUS INJURY OR DEATH. KEEP CHILDREN AWAY. PACEMAKER WEARERS SHOULD CONSULT WITH THEIR DOCTOR BEFORE OPERATING.

Read and understand the following safety highlights. For additional safety information, it is strongly recommended that you purchase a copy of "Safety in Welding & Cutting - ANSI Standard Z49.1" from the American Welding Society, P.O. Box 351040, Miami, Florida 33135 or CSA Standard W117.2-1974. A Free copy of "Arc Welding Safety" booklet E205 is available from the Lincoln Electric Company, 22801 St. Clair Avenue, Cleveland, Ohio 44117-1199.

BE SURE THAT ALL INSTALLATION, OPERATION, MAINTENANCE AND REPAIR PROCEDURES ARE PERFORMED ONLY BY QUALIFIED INDIVIDUALS.



FOR ENGINE powered equipment.

1.a. Turn the engine off before troubleshooting and maintenance work unless the maintenance work requires it to be running.



1.b. Operate engines in open, well-ventilated areas or vent the engine exhaust fumes outdoors.



1.c. Do not add the fuel near an open flame welding arc or when the engine is running. Stop the engine and allow it to cool before refueling to prevent spilled fuel from vaporizing on contact with hot engine parts and igniting. Do not spill fuel when filling tank. If fuel is spilled, wipe it up and do not start engine until fumes have been eliminated.

1.d. Keep all equipment safety guards, covers and devices in position and in good repair. Keep hands, hair, clothing and tools away from V-belts, gears, fans and all other moving parts when starting, operating or repairing equipment.

1.e. In some cases it may be necessary to remove safety guards to perform required maintenance. Remove guards only when necessary and replace them when the maintenance requiring their removal is complete. Always use the greatest care when working near moving parts.



1.f. Do not put your hands near the engine fan. Do not attempt to override the governor or idler by pushing on the throttle control rods while the engine is running.

1.g. To prevent accidentally starting gasoline engines while turning the engine or welding generator during maintenance work, disconnect the spark plug wires, distributor cap or magneto wire as appropriate.



1.h. To avoid scalding, do not remove the radiator pressure cap when the engine is hot.



ELECTRIC AND MAGNETIC FIELDS may be dangerous

2.a. Electric current flowing through any conductor causes localized Electric and Magnetic Fields (EMF). Welding current creates EMF fields around welding cables and welding machines

2.b. EMF fields may interfere with some pacemakers, and welders having a pacemaker should consult their physician before welding.

2.c. Exposure to EMF fields in welding may have other health effects which are now not known.

2.d. All welders should use the following procedures in order to minimize exposure to EMF fields from the welding circuit:

2.d.1. Route the electrode and work cables together - Secure them with tape when possible.

2.d.2. Never coil the electrode lead around your body.

2.d.3. Do not place your body between the electrode and work cables. If the electrode cable is on your right side, the work cable should also be on your right side.

2.d.4. Connect the work cable to the workpiece as close as possible to the area being welded.

2.d.5. Do not work next to welding power source.



ELECTRIC SHOCK can kill.

3.a. The electrode and work (or ground) circuits are electrically "hot" when the welder is on. Do not touch these "hot" parts with your bare skin or wet clothing. Wear dry, hole-free gloves to insulate hands.

3.b. Insulate yourself from work and ground using dry insulation. Make certain the insulation is large enough to cover your full area of physical contact with work and ground.

In addition to the normal safety precautions, if welding must be performed under electrically hazardous conditions (in damp locations or while wearing wet clothing; on metal structures such as floors, gratings or scaffolds; when in cramped positions such as sitting, kneeling or lying, if there is a high risk of unavoidable or accidental contact with the workpiece or ground) use the following equipment:

- Semiautomatic DC Constant Voltage (Wire) Welder.
- DC Manual (Stick) Welder.
- AC Welder with Reduced Voltage Control.

3.c. In semiautomatic or automatic wire welding, the electrode, electrode reel, welding head, nozzle or semiautomatic welding gun are also electrically "hot".

3.d. Always be sure the work cable makes a good electrical connection with the metal being welded. The connection should be as close as possible to the area being welded.

3.e. Ground the work or metal to be welded to a good electrical (earth) ground.

3.f. Maintain the electrode holder, work clamp, welding cable and welding machine in good, safe operating condition. Replace damaged insulation.

3.g. Never dip the electrode in water for cooling.

3.h. Never simultaneously touch electrically "hot" parts of electrode holders connected to two welders because voltage between the two can be the total of the open circuit voltage of both welders.

3.i. When working above floor level, use a safety belt to protect yourself from a fall should you get a shock.

3.j. Also see Items 6.c. and 8.



ARC RAYS can burn.

4.a. Use a shield with the proper filter and cover plates to protect your eyes from sparks and the rays of the arc when welding or observing open arc welding. Headshield and filter lens should conform to ANSI Z87. 1 standards.

4.b. Use suitable clothing made from durable flame-resistant material to protect your skin and that of your helpers from the arc rays.

4.c. Protect other nearby personnel with suitable, non-flammable screening and/or warn them not to watch the arc nor expose themselves to the arc rays or to hot spatter or metal.



FUMES AND GASES can be dangerous.

5.a. Welding may produce fumes and gases hazardous to health. Avoid breathing these fumes and gases. When welding, keep your head out of the fume. Use enough ventilation and/or exhaust at the arc to keep

fumes and gases away from the breathing zone. **When welding with electrodes which require special ventilation such as stainless or hard facing (see instructions on container or MSDS) or on lead or cadmium plated steel and other metals or coatings which produce highly toxic fumes, keep exposure as low as possible and within applicable OSHA PEL and ACGIH TLV limits using local exhaust or mechanical ventilation. In confined spaces or in some circumstances, outdoors, a respirator may be required. Additional precautions are also required when welding on galvanized steel.**

5. b. The operation of welding fume control equipment is affected by various factors including proper use and positioning of the equipment, maintenance of the equipment and the specific welding procedure and application involved. Worker exposure level should be checked upon installation and periodically thereafter to be certain it is within applicable OSHA PEL and ACGIH TLV limits.

5.c. Do not weld in locations near chlorinated hydrocarbon vapors coming from degreasing, cleaning or spraying operations. The heat and rays of the arc can react with solvent vapors to form phosgene, a highly toxic gas, and other irritating products.

5.d. Shielding gases used for arc welding can displace air and cause injury or death. Always use enough ventilation, especially in confined areas, to insure breathing air is safe.

5.e. Read and understand the manufacturer's instructions for this equipment and the consumables to be used, including the material safety data sheet (MSDS) and follow your employer's safety practices. MSDS forms are available from your welding distributor or from the manufacturer.

5.f. Also see item 1.b.

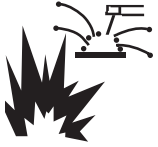

WELDING and CUTTING SPARKS can cause fire or explosion.

6.a. Remove fire hazards from the welding area. If this is not possible, cover them to prevent the welding sparks from starting a fire.

Remember that welding sparks and hot materials from welding can easily go through small cracks and openings to adjacent areas. Avoid welding near hydraulic lines. Have a fire extinguisher readily available.

- 6.b. Where compressed gases are to be used at the job site, special precautions should be used to prevent hazardous situations. Refer to "Safety in Welding and Cutting" (ANSI Standard Z49.1) and the operating information for the equipment being used.
- 6.c. When not welding, make certain no part of the electrode circuit is touching the work or ground. Accidental contact can cause overheating and create a fire hazard.
- 6.d. Do not heat, cut or weld tanks, drums or containers until the proper steps have been taken to insure that such procedures will not cause flammable or toxic vapors from substances inside. They can cause an explosion even though they have been "cleaned". For information, purchase "Recommended Safe Practices for the Preparation for Welding and Cutting of Containers and Piping That Have Held Hazardous Substances", AWS F4.1 from the American Welding Society (see address above).
- 6.e. Vent hollow castings or containers before heating, cutting or welding. They may explode.
- 6.f. Sparks and spatter are thrown from the welding arc. Wear oil free protective garments such as leather gloves, heavy shirt, cuffless trousers, high shoes and a cap over your hair. Wear ear plugs when welding out of position or in confined places. Always wear safety glasses with side shields when in a welding area.
- 6.g. Connect the work cable to the work as close to the welding area as practical. Work cables connected to the building framework or other locations away from the welding area increase the possibility of the welding current passing through lifting chains, crane cables or other alternate circuits. This can create fire hazards or overheat lifting chains or cables until they fail.
- 6.h. Also see item 1.c.
- 6.i. Read and follow NFPA 51B "Standard for Fire Prevention During Welding, Cutting and Other Hot Work", available from NFPA, 1 Batterymarch Park, PO box 9101, Quincy, Ma 022690-9101.
- 6.j. Do not use a welding power source for pipe thawing.



CYLINDER may explode if damaged.

7.a. Use only compressed gas cylinders containing the correct shielding gas for the process used and properly operating regulators designed for the gas and pressure used. All hoses, fittings, etc. should be suitable for the application and maintained in good condition.

- 7.b. Always keep cylinders in an upright position securely chained to an undercarriage or fixed support.
- 7.c. Cylinders should be located:
 - Away from areas where they may be struck or subjected to physical damage.
 - A safe distance from arc welding or cutting operations and any other source of heat, sparks, or flame.
- 7.d. Never allow the electrode, electrode holder or any other electrically "hot" parts to touch a cylinder.
- 7.e. Keep your head and face away from the cylinder valve outlet when opening the cylinder valve.
- 7.f. Valve protection caps should always be in place and hand tight except when the cylinder is in use or connected for use.
- 7.g. Read and follow the instructions on compressed gas cylinders, associated equipment, and CGA publication P-1, "Precautions for Safe Handling of Compressed Gases in Cylinders," available from the Compressed Gas Association 1235 Jefferson Davis Highway, Arlington, VA 22202.



FOR ELECTRICALLY powered equipment.

- 8.a. Turn off input power using the disconnect switch at the fuse box before working on the equipment.
- 8.b. Install equipment in accordance with the U.S. National Electrical Code, all local codes and the manufacturer's recommendations.
- 8.c. Ground the equipment in accordance with the U.S. National Electrical Code and the manufacturer's recommendations.

Refer to <http://www.lincolnelectric.com/safety> for additional safety information.

PRÉCAUTIONS DE SÛRETÉ

Pour votre propre protection lire et observer toutes les instructions et les précautions de sûreté spécifiques qui paraissent dans ce manuel aussi bien que les précautions de sûreté générales suivantes:

Sûreté Pour Soudage A L'Arc

1. Protégez-vous contre la secousse électrique:
 - a. Les circuits à l'électrode et à la pièce sont sous tension quand la machine à souder est en marche. Eviter toujours tout contact entre les parties sous tension et la peau nue ou les vêtements mouillés. Porter des gants secs et sans trous pour isoler les mains.
 - b. Faire très attention de bien s'isoler de la masse quand on soude dans des endroits humides, ou sur un plancher métallique ou des grilles métalliques, principalement dans les positions assis ou couché pour lesquelles une grande partie du corps peut être en contact avec la masse.
 - c. Maintenir le porte-électrode, la pince de masse, le câble de soudage et la machine à souder en bon et sûr état de fonctionnement.
 - d. Ne jamais plonger le porte-électrode dans l'eau pour le refroidir.
 - e. Ne jamais toucher simultanément les parties sous tension des porte-électrodes connectés à deux machines à souder parce que la tension entre les deux pinces peut être le total de la tension à vide des deux machines.
 - f. Si on utilise la machine à souder comme une source de courant pour soudage semi-automatique, ces précautions pour le porte-électrode s'appliquent aussi au pistolet de soudage.
2. Dans le cas de travail au dessus du niveau du sol, se protéger contre les chutes dans le cas où on reçoit un choc. Ne jamais enrouler le câble-électrode autour de n'importe quelle partie du corps.
3. Un coup d'arc peut être plus sévère qu'un coup de soleil, donc:
 - a. Utiliser un bon masque avec un verre filtrant approprié ainsi qu'un verre blanc afin de se protéger les yeux du rayonnement de l'arc et des projections quand on soude ou quand on regarde l'arc.
 - b. Porter des vêtements convenables afin de protéger la peau de soudeur et des aides contre le rayonnement de l'arc.
 - c. Protéger l'autre personnel travaillant à proximité au soudage à l'aide d'écrans appropriés et non-inflammables.
4. Des gouttes de laitier en fusion sont émises de l'arc de soudage. Se protéger avec des vêtements de protection libres de l'huile, tels que les gants en cuir, chemise épaisse, pantalons sans revers, et chaussures montantes.
5. Toujours porter des lunettes de sécurité dans la zone de soudage. Utiliser des lunettes avec écrans latéraux dans les zones où l'on pique le laitier.

6. Eloigner les matériaux inflammables ou les recouvrir afin de prévenir tout risque d'incendie dû aux étincelles.
7. Quand on ne soude pas, poser la pince à un endroit isolé de la masse. Un court-circuit accidentel peut provoquer un échauffement et un risque d'incendie.
8. S'assurer que la masse est connectée le plus près possible de la zone de travail qu'il est pratique de le faire. Si on place la masse sur la charpente de la construction ou d'autres endroits éloignés de la zone de travail, on augmente le risque de voir passer le courant de soudage par les chaînes de levage, câbles de grue, ou autres circuits. Cela peut provoquer des risques d'incendie ou d'échauffement des chaînes et des câbles jusqu'à ce qu'ils se rompent.
9. Assurer une ventilation suffisante dans la zone de soudage. Ceci est particulièrement important pour le soudage de tôles galvanisées plombées, ou cadmiées ou tout autre métal qui produit des fumées toxiques.
10. Ne pas souder en présence de vapeurs de chlore provenant d'opérations de dégraissage, nettoyage ou pistolage. La chaleur ou les rayons de l'arc peuvent réagir avec les vapeurs du solvant pour produire du phosgène (gas fortement toxique) ou autres produits irritants.
11. Pour obtenir de plus amples renseignements sur la sûreté, voir le code "Code for safety in welding and cutting" CSA Standard W 117.2-1974.

PRÉCAUTIONS DE SÛRETÉ POUR LES MACHINES À SOUDER À TRANSFORMATEUR ET À REDRESSEUR

1. Relier à la terre le châssis du poste conformément au code de l'électricité et aux recommandations du fabricant. Le dispositif de montage ou la pièce à souder doit être branché à une bonne mise à la terre.
2. Autant que possible, l'installation et l'entretien du poste seront effectués par un électricien qualifié.
3. Avant de faire des travaux à l'intérieur de poste, la débrancher à l'interrupteur à la boîte de fusibles.
4. Garder tous les couvercles et dispositifs de sûreté à leur place.

Thank You

for selecting a **QUALITY** product by Lincoln Electric. We want you to take pride in operating this Lincoln Electric Company product
••• as much pride as we have in bringing this product to you!

CUSTOMER ASSISTANCE POLICY

The business of The Lincoln Electric Company is manufacturing and selling high quality welding equipment, consumables, and cutting equipment. Our challenge is to meet the needs of our customers and to exceed their expectations. On occasion, purchasers may ask Lincoln Electric for advice or information about their use of our products. We respond to our customers based on the best information in our possession at that time. Lincoln Electric is not in a position to warrant or guarantee such advice, and assumes no liability, with respect to such information or advice. We expressly disclaim any warranty of any kind, including any warranty of fitness for any customer's particular purpose, with respect to such information or advice. As a matter of practical consideration, we also cannot assume any responsibility for updating or correcting any such information or advice once it has been given, nor does the provision of information or advice create, expand or alter any warranty with respect to the sale of our products.

Lincoln Electric is a responsive manufacturer, but the selection and use of specific products sold by Lincoln Electric is solely within the control of, and remains the sole responsibility of the customer. Many variables beyond the control of Lincoln Electric affect the results obtained in applying these types of fabrication methods and service requirements.

Subject to Change – This information is accurate to the best of our knowledge at the time of printing. Please refer to www.lincolnelectric.com for any updated information.

Please Examine Carton and Equipment For Damage Immediately

When this equipment is shipped, title passes to the purchaser upon receipt by the carrier. Consequently, Claims for material damaged in shipment must be made by the purchaser against the transportation company at the time the shipment is received.

Please record your equipment identification information below for future reference. This information can be found on your machine nameplate.

Product _____

Model Number _____

Code Number or Date Code _____

Serial Number _____

Date Purchased _____

Where Purchased _____

Whenever you request replacement parts or information on this equipment, always supply the information you have recorded above. The code number is especially important when identifying the correct replacement parts.

On-Line Product Registration

- Register your machine with Lincoln Electric either via fax or over the Internet.
- For faxing: Complete the form on the back of the warranty statement included in the literature packet accompanying this machine and fax the form per the instructions printed on it.
- For On-Line Registration: Go to our **WEB SITE at www.lincolnelectric.com**. Choose "Quick Links" and then "Product Registration". Please complete the form and submit your registration.

Read this Operators Manual completely before attempting to use this equipment. Save this manual and keep it handy for quick reference. Pay particular attention to the safety instructions we have provided for your protection. The level of seriousness to be applied to each is explained below:

⚠ WARNING

This statement appears where the information **must** be followed **exactly** to avoid **serious personal injury or loss of life**.

⚠ CAUTION

This statement appears where the information **must** be followed to avoid **minor personal injury or damage to this equipment**.

TABLE OF CONTENTS

	Page
Safety Precautions	2-5
Introductory Information	7
Meaning of Graphic Symbols	8-11
General Machine Description.....	12
Recommended Processes & Equipment	12
Design Summary	12
Operational Features & Controls	12-14
Technical Specifications	15
Installation	16-18
Safety Precautions	16
Location	16
Application Limitations.....	16
Stacking.....	16
Input Power Connections	16
Output Cable Connections	17
Installation of Field Installed Options	17-18
Installation of Equipment Required for Recommended Processes	18
Operating Instructions	19
Safety Precautions	19
Power Source Operation	19-21
Duty Cycle	19
Starting the Machine.....	19
Control Settings & Descriptions.....	19-21
Maintenance	21
Routine Maintenance.....	21
Troubleshooting.....	22-25
Procedure for Replacing P.C. Boards.....	26
Remote Control & System Checks	27
Twist Mate Welding Cable Plug Instructions.....	28
Diagrams	29-30
Parts Pages.....	P236 Series

MEANINGS OF GRAPHIC SYMBOLS

The CV 500-I nameplate has been designed to use international symbols in describing the function of the various components. Below are the symbols used.

POWER ON-OFF SWITCH

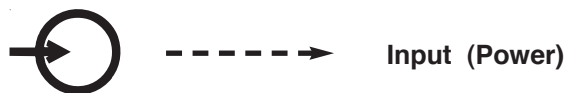

OUTPUT CONTROL DIAL

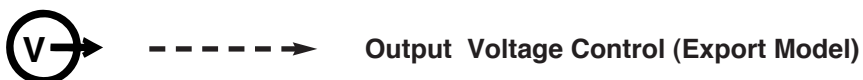

OUTPUT CONTROL "LOCAL-REMOTE" SWITCH



CIRCUIT BREAKER









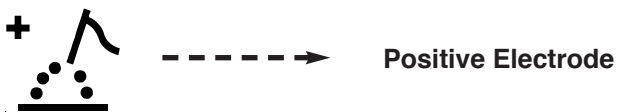

THERMAL PROTECTION LIGHT



VOLTMETER SWITCH



RATING PLATE

NEMA EW 1	----->	Designates welder complies with National Electrical Manufacturers Association requirements EW 1. (Export Model only)
IEC 974-1	----->	Designates welder complies with International Electrotechnical commission requirements 974-1. (European model only)
3 ~	----->	Three Phase Power
	----->	Transformer
	----->	Rectifier
	----->	Rectified DC Output
	----->	Constant Voltage Characteristic
	----->	Line Connection
	----->	Shielded Metal Arc Welding
	----->	Flux Cored Arc Welding
	----->	Designates Welder can be used in environments with increased hazard of electric shock. (European model only)
IP21	----->	Degree of protection provided by the enclosure

WARNING IDENTIFICATION



Warning Identification

EARTH GROUND CONNECTION



Signifying the Earth (Ground) Connection

CHASSIS GROUND CONNECTION



Signifying the Chassis (Ground) Connection

GENERAL MACHINE DESCRIPTION

The CV 500-I is an SCR controlled three phase DC power source. It is designed with a single range potentiometer control.

The CV500-I has two models - an Export model and a European model. The Export model complies with NEMA EW 1 requirements and the European model complies with IEC 974-1 requirements.

RECOMMENDED PROCESSES & EQUIPMENT

The CV 500-I is supplied as a constant voltage power source only. It is designed for all Innershield®, Outershield® and all solid wire and gas procedures within the capacity of the machine. The output characteristics have been optimized for these CV processes without use of a variable arc control.

The CV 500-I is designed to be used with the LN-7*, LN-7 GMA*, LN-8*, LN-9*, LN-9 GMA*, LN-22, LN-23P**, LN-25, or LN-742 semiautomatic wire feeders, the NA-3*, NA-5* and NA-5R* automatics within the capacity of the machine. The CV 500-I Diode option is required to utilize the cold start and cold electrode sensing features of the NA-3, NA-5 and NA-5R.

* The 14 pin receptacle of the European model does not provide 115 VAC for these feeders..

** Use K350 Adapter Kit.

DESIGN SUMMARY

Operational Features & Controls

ARC CHARACTERISTICS

Through the unique combination of the transformer, three phase semiconverter rectifier, capacitor bank, and output choke design, in conjunction with the solid state control system, an outstanding constant voltage welding performance is achieved with a fixed pinch setting optimized for the most popular arc characteristics.

OUTPUT VOLTAGE CONTROL

The OUTPUT voltage control, a small 2 watt potentiometer, is calibrated from 1 to 10.

MACHINE OUTPUT CONTROL SWITCH “LOCAL” OR “REMOTE”

The machine output voltage can be controlled by either the “OUTPUT CONTROL” on the machine control panel, the output control on the wire feed unit, or an optional “remote control” that is available. This switch selects the mode of control, either “LOCAL” or “REMOTE”.

POLARITY SELECTION

Polarity selection is made by appropriately connecting the electrode and work welding cables to either the “+” stud or to the “-” stud. Select “VOLTMETER” switch for “+” or “-” electrode, for the remote (#21) work sensing lead.

VOLTMETER SWITCH “+” ELECTRODE OR “-” ELECTRODE

This switch selects electrode polarity for the remote (#21) work sensing lead of automatic or semiautomatic equipment.

115 VOLT POWER SWITCH

The power input contactor operates from an auxiliary 115 volt transformer that is energized through the POWER toggle switch on the machine control panel. “I” is on and “O” is off.

PILOT LIGHT

A white light on the machine control panel indicates when the power source input contactor is closed. This means the main power transformer and all auxiliary and control transformers are energized.

THERMAL PROTECTION LIGHT

An amber light on the machine control panel indicates when either of the two protective thermostats have opened. Output power will be removed but input power will still be applied to the machine.

INPUT CONTACTOR

The power source is equipped with an input contactor.

AUXILIARY POWER CONNECTIONS

The power source is equipped to furnish nominally 115 volt AC and 42 volt AC auxiliary power for operating wire feeding equipment, etc. The auxiliary power is available at the 14-pin MS-style connector receptacle on the control panel and/or at a terminal strip behind the hinged control panel on the front of the power source. 115V AC is available at receptacle pins A and J, (except on European model), and terminals 31 and 32. 42V AC is available only at receptacle pins I and K. The 115V AC and the 42V AC are isolated circuits and each is protected by a 10 amp circuit breaker.

REMOTE CONTROL CONNECTIONS

Remote control connections are available both at a 14-pin connector receptacle located on the control panel, and on terminal strips with screw connections located behind the hinged control panel on the front of the power source.

WATER COOLER CONNECTOR

A Continental European receptacle (220V Schuko type) is located on the rear panel for supplying 220VAC to a water cooler. A 2 amp circuit breaker which is also located on the rear panel protects this circuit.

OUTPUT CONNECTIONS

The output terminals are recessed on the case front and labeled “+” and “-”. The CV 500-I provides Twist-Mate™ European connector receptacles.

K852 Twist-Mate European connector plugs are available for the cable size to be used. The Export model includes two Twist-Mate plugs for 2/0 - 3/0 (70-95mm²) cable and S18737 installation instructions.

INPUT CONNECTIONS

The three input lines are brought in through the rear panel of the power source and attached to the input contactor. Removal of the removable access panel makes the contactor accessible for the input cable connections.

INPUT LINE VOLTAGE COMPENSATION

The power source is equipped with input line voltage compensation as standard. For a line voltage fluctuation of $\pm 10\%$ the output will remain essentially constant. This is accomplished through the feedback network in the control circuit.

SOLID STATE OUTPUT CONTROL

The output of the welder is electronically controlled by SCR's instead of mechanical contactors, providing extra long life for highly repetitive welding applications.

SOLID STATE CONTROL SYSTEM

The Control PC Board is located behind the control panel which hinges down for easy access to the board. The Snubber PC Board is mounted on the back of the case front.

MACHINE COOLING

The fan pulls air in through the louvered front of the machine over the internal parts and exhausts out the louvered rear of the machine. The fan motor is fully enclosed, has sealed ball bearings, requires no lubrication, and operates when the power switch is turned on.

CASE FEATURES

The machine uses a 32" (813mm) long base. The low profile case facilitates installation of the machine under a workbench and stacking the machines three high to conserve floor space.

The case front incorporates a recessed hinged control panel where all the machine controls are mounted. This recessed panel protects the controls and minimizes the possibilities of accidental contact. This control panel can be easily opened to permit access to the enclosed section which contains the terminal strips, PC board, etc. The output lead terminals are also recessed to avoid any object or person accidentally coming in contact with an output terminal.

The individual case sides are removable for easy access for internal service or inspection. These are removable even though the machines are stacked three high.

The case rear, top section, is equipped with a removable access panel. This provides easy access to the input contactor, easy connection and reconnection of input leads, and easy access for service or inspection.

Although the machine is designed for use in rain-sheltered environments, the transformer and choke assembly are dipped in a special corrosion resistant epoxy paint.

A permanent lifting hook is located at the top of the machine and is positioned so that it acts as nearly as possible through the center of gravity. This lift hook is so positioned that it fits without interference under the base of the second machine when stacking.

PARALLELING

There are no provisions on the CV 500-I to permit paralleling.

DIODE OPTION (Factory installed only)

The CV 500-I Diode option is required to utilize the cold start and cold electrode sensing features of the NA-3, NA-5 or NA-5R. When this option is not used with an NA-3, NA-5 or NA-5R, see the CV 500-I / NA-3, CV 500-I / NA-5 or CV 500-I / NA-5R connection diagram for instructions on how to disable this circuit. If the circuit is not disabled, the wire cannot be inched down.

METER OPTION

Factory installed Ammeter and Voltmeter

Machine & Circuit Protection (Thermal Protection Light)

The power source is thermostatically protected with proximity thermostats against overload or insufficient cooling. One thermostat is located on the nose of the center bottom primary coil and a second thermostat is attached to the lead connecting the secondaries. Both thermostats are connected in a series with the 2-4 circuit. If the machine is overloaded, the primary thermostat will open, the output will be zero, and the thermal protection light will be on; the fan will continue to run. The secondary thermostat will open either with an excessive overload or insufficient cooling. The output will be zero and the protection light will be on; the fan will continue to run. When the thermostats reset the protection light will be off.

The power source is also protected against overloads on the SCR bridge assembly through an electronic protection circuit. This circuit senses an overload on the power source and limits the output to 550 amps by phasing back the SCR's.

Protection is provided to protect the circuitry from accidental grounds. If the customer accidentally "grounds" 75, 76, or 77 to the positive output lead, the output will be reduced to a low value, thus preventing any damage to the machine. If the ground occurs between 75, 76, 77 and the negative output lead, one of the PC board "self-restoring" fuses will blow, preventing any machine damage. After the ground is cleared, the fuses automatically reset within a few seconds.

TECHNICAL SPECIFICATIONS

Model	CV 500-I
Type	K1347
Frequency	50/60 Hz
Output Rating	DC
Amperes	500 450 400
Volts NEMA EW1	40 38 36
IEC 974-1	39 36.5 34
Duty Cycle	50% 60% 100%
Output Range (Min.)	60A 12V
(Max.)	500A 42V
Max. O.C.V.	46
Input Ratings	220/440
Standard Voltages	220/380/440
	230/460
Single Voltages (Available)	Yes
Rated Current	45A @ 400A 34V (380V/50 Hz)
Input kVA	29.6 @ 400A 34V (50 Hz)
Power Factor	.65 @ 400A 34V (50 Hz)
Efficiency	70% @ 400A 34V (50 Hz)
Idle Current	3.2A (380V 50 Hz)
Idle Power	1.0 KW (50 Hz)
Optional Features	
Remote Control Adapter Cable	Yes
115V Starter Circuit	Standard
Suitable Undercarriages	Yes
Remote output Control	Yes
Other Features	Stackable Case
Net Weight	383 Lbs (174 kg)
Dimension Print	M12244-7
Wiring Diagram	L9269
Standards Compliance	IEC 974-1, <input type="checkbox"/> Rated (230/400V only) NEMA EW1 (All others) IP21 (All)
Operating Temperature	-40°C to +40°C

INSTALLATION

Safety Precautions

⚠ WARNING



ELECTRIC SHOCK can kill.

- Do not touch electrically live parts or electrode with skin or wet clothing.
- Insulate yourself from work and ground.
- Always wear dry insulating gloves.



FUMES AND GASES can be dangerous.

- Keep your head out of fumes.
- Use ventilation or exhaust to remove fumes from breathing zone.

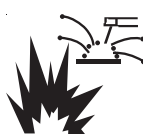

WELDING SPARKS can cause fire or explosion.

- Keep flammable material away.
- Do not weld on closed containers.



ARC RAYS can burn eyes and skin.

- Wear eye, ear and body protection.

See additional warning information at front of this operator's manual.

LOCATION

The machine should be located in a clean, dry place where there is free circulation of clean air such that air movement in through the front and out through the back will not be restricted. Dirt and dust that can be drawn into the machine should be kept to a minimum. Failure to observe these precautions can result in excessive operating temperatures and nuisance shut-down of the machine.

APPLICATION LIMITATIONS

There are no provisions on the CV 500-I for paralleling, and outdoor operations without rain sheltering is not recommended.

STACKING

⚠ WARNING



FALLING EQUIPMENT can cause injury.

- Do not lift this machine using lift bale if it is equipped with a heavy accessory such as trailer or gas cylinder.
- Lift only with equipment of adequate lifting capacity.
- Be sure machine is stable when lifting.
- Do not stack more than three high.
- Do not stack the CV 500-I on top of any other machine.

The units may be stacked three high by observing the following safety precautions.

1. Make sure the first or bottom unit is setting on a level, well supported surface.
2. The units must be stacked with their fronts flush, making sure the two holes in the base rails of the unit being stacked on top are over the two holes located on the top front corners of the unit it is being stacked on. Fasten the units together with 5/16 bolts, nuts and lockwashers through these holes.
3. Remove fastening bolts before lifting unit off stacks.

Input Power Connections

By removing the rear access panel the three phase input power is connected to the three line terminals on the input contactor, and the earth grounding lead to the grounding terminal on the input box floor marked with the \oplus symbol. Install the reconnect panel jumper links for the proper input voltage per the diagram pasted inside the access panel cover.

See Installation Data below:

INSTALLATION DATA						
Input Rating			Recommended input wire and fuse sizes for maximum rated output. In addition, follow latest National Electrical Code and Local Code.			
Voltage	Hertz	Amperes** on Nameplate	Input Wire Size* (Type 75°C Copper Conductors in Conduit) AWG	Minimum Grounding Wire Size (Copper Conductors) AWG	BUSSMANN SUPER-LAG FUSE SIZE AND CATALOG NUMBER***	
					FUSE SIZE	CATALOG NUMBER
220	50/60	78	3 (27mm ²)	8 (10mm ²)	100	REN-100
230		75	4 (21mm ²)	8 (10mm ²)	100	REN-100
380		45	6 (13mm ²)	10 (5.3mm ²)	60	RES-60
400		43	8 (8.4mm ²)	10 (5.3mm ²)	60	RES-60
440		39	8 (8.4mm ²)	10 (5.3mm ²)	50	RES-50

* Ambient temperature of 40°C (104°F).

** At rated output of 400A, 100% duty cycle.

*** Use only Bussmann Super-Lag fuses specified. Other fuses may not protect the welder and may cause overheating and possible fire damage.



CAUTION

Failure to follow these instructions can cause immediate failure of components within the machine. When powering welder from a generator be sure to turn off the welder first, before generator is shut down in order to prevent damage to welder.

Output Cable Connections

The output leads are connected to the output terminals marked “+” and “-”. They are located at the lower right and lower left corners of the front panel. The CV 500-I provides Twist-Mate European weld cable connector receptacles.

K852 Twist-Mate European connector plugs are available for the cable size to be used. The Export model includes two Twist-Mate plugs for 2/0 - 3/0 (70-95mm2) cable and S18737 installation instructions. This information is also located at the rear of this manual.

Output Cables

CABLE SIZES FOR COMBINED LENGTH OF ELECTRODE AND WORK CABLE

CABLE LENGTHS	MACHINE LOAD	
	400A (100% DUTY CYCLE)	500A (50% DUTY CYCLE)
UP TO 50 ft (15m)	3/0 85 mm ²	2/0 67 mm ²
50 to 100 ft (15-30 m)	3/0 85 mm ²	2/0 67 mm ²
100-150 ft (30-46 m)	3/0 85 mm ²	3/0 85 mm ²
150-200 ft (46-61 m)	3/0 85 mm ²	3/0 85 mm ²
200-250 ft (67-76 m)	4/0 107 mm ²	4/0 107 mm ²

Installation of Field Installed Options

REMOTE OUTPUT CONTROL (K857 WITH K864 ADAPTER OR K775)

The K857 has a 6-pin MS-style connector. The K857 requires a K864 adapter cable which connects to the 14-pin connector on the machine.

The K775 consists of a control box with 28 ft (8.5m) of four conductor cable. This connects to terminals 75, 76, and 77 on the terminal strip and the case grounding screw so marked with the symbol  on the machine. These terminals are located behind the control panel on the front of the power source. This control will give the same control as the output control on the machine.

REMOTE CONTROL ADAPTER CABLE (K864)

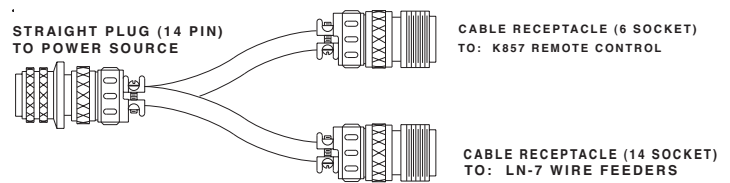

A “V” cable 12” (.30m) long to connect a K857 Remote Control (6 pin connector) with a wire-feeder (14-pin connector) and the machine (14-pin connector). If a remote control is used alone the wire-feeder connection is then not used.



WARNING



ELECTRIC SHOCK can kill.

- Turn the power switch of the welding power source “OFF” before installing plugs on cables or when connecting or disconnecting plugs to welding power source.

CAPACITOR DISCHARGE CIRCUIT (K828-1)

Circuit that mounts inside the CV 500-I. Recommended when:

- 1) CV 500-I is used in conjunction with any LN-23P or older LN-8 or LN-9 semiautomatic wire-feeder. Eliminates possible arc flash re-start of weld when trigger interlock is used. Not required with current LN-8 (above Code 8700), or LN-9’s with serial numbers above 115187 (manufactured after 12/83), or any LN-9 having an L6043-1 Power PC Board.
- 2) CV 500-I is used with an LN-22 equipped with an older K279 Contactor-Voltage Control Option. Eliminates electrode overrun when gun trigger is released. Not required when later K279 (above Code 8800) is used.
- 3) CV 500-I is used with any semiautomatic wire-feeder and possible small spark, if electrode touches work just after gun trigger is released, is objectionable.

Install per M17060 instructions included with the Kit.

UNDERCARRIAGES (K817P, K841)

For easy moving of the machine, optional undercarriages are available with polyolefin wheels (K817P) or a platform undercarriage (K841) with mountings for two gas cylinders at rear of welder.

Install per instructions provided with undercarriage.

Installation of Equipment Required for Recommended Processes

WIRE FEEDER CONTROL CABLE CONNECTIONS

For control cable with 14-pin connector:

Connect control cable to 14-pin connector on the front panel of the machine. See the appropriate connection diagram for the exact instructions for the wire feeder being used. Refer to "115VAC and 42VAC Auxiliary Power and Control Connections" section for connector pin functions.

A cover (Lincoln Electric Part Number S17062-3) is available for the unused 14-pin connector to protect it against dirt and moisture.

For control cable with terminal strip connectors:

The control cable from the wire feeding equipment is connected to the terminal strips behind the control panel. A strain relief box connector is provided for access into the terminal strip section. A chassis ground screw is also provided below the terminal strip marked with the symbol \oplus for connecting the automatic equipment grounding wire. See the appropriate connection diagram for the exact instructions for the wire feeder being used. Refer to "115VAC and 42VAC Auxiliary Power and Control Connections" section for access to terminal strips.

CONNECTION OF CV 500-I TO LN-22 OR LN-25

- a) Turn off all power.
- b) Connect a jumper from "2 to 4" on terminal strip TS2 or jumper pins "C to D" in 14-pin connector plug (a K484 14-pin jumper plug is available).
- c) Connect the electrode cable to the output terminal of polarity required by electrode. Connect the work lead to the other terminal.
- d) Place the OUTPUT CONTROL Switch at "LOCAL" position unless a Remote Control is connected to the CV 500-I.

NOTE: The output terminals are energized at all times.

OPERATING INSTRUCTIONS

Safety Precautions

WARNING



ELECTRIC SHOCK can kill.

- Have an electrician install and service this equipment.
- Turn the input power off at the fuse box before working on equipment.
- Do not touch electrically hot parts.
- This next section applies to CV 500-I's without the Capacitor Discharge Option:

When using a CV 500-I power source with wire feeders, there will be a small spark if the electrode contacts the work or ground within several seconds after releasing the trigger.

When used with some wire feeders with the electrical trigger interlock in the ON position, the arc can restart if the electrode touches the work or ground during these several seconds.

POWER SOURCE OPERATION

Duty Cycle and Time Period

The CV 500-I is rated at the following duty cycles:

Duty Cycle*	Amps	Volts
100%	400	36
60%	450	38
50%	500	40

* Based upon a 10 minute time period. (i.e., for 60% duty cycle, it is 6 minutes on and 4 minutes off).

Overloading the power source may result in opening of an internal protective thermostat as indicated by the amber thermal protection light turning on.

STARTING THE MACHINE

The POWER toggle switch at the extreme right side of the control panel in the “ I ” position energizes and closes the three phase input contactor from a 115 volt auxiliary transformer. This in turn energizes the main power transformer.

The machine is de-energized when the POWER switch is in the “0” position.

The white light next to the POWER switch indicates when the input contactor is energized.

CONTROL SETTINGS & DESCRIPTIONS

OUTPUT VOLTAGE CONTROL DIAL

The Output control dial at the right of the control panel is a continuous control of the machine output voltage. The control may be rotated between minimum and maximum to adjust the machine output, even while welding.

The machine is equipped with line voltage compensation as a standard feature. This will hold the output constant except at maximum output of the machine, through a fluctuation of $\pm 10\%$ input line voltage.

OUTPUT CONTROL “LOCAL-REMOTE” SWITCH

The Output Control toggle switch on the control panel labeled “Local-Remote” gives the operator the option of controlling the output at the machine control panel or at a remote station. For remote control, the toggle switch is set in the “Remote” position and controlled at the wire feed unit control, or by connecting a K775 control to terminals 75, 76, and 77 on the terminal strip at the front of the machine, or by connecting a K857 control with a K864 adapter to the 14-pin connector on the front of the machine. For control at the machine control panel (Output Voltage control dial), the toggle switch is set in the “Local” position.

(Exception: When used with an LN-9, LN-9 GMA or NA-5 wire feeder, the Output Control switch must be in the “Remote” position or automatic shutdown of the LN-9 or NA-5 may occur.)

POLARITY SELECTION

Polarity selection is made by appropriately connecting the electrode and work welding cables to either the “+” terminal or to the “-” terminal. Select “Voltmeter” switch for “+” or “-” electrode for the remote (#21) work sensing lead.

VOLTMETER SWITCH

Select “+” for positive electrode or “-” for negative electrode. This switch selects electrode polarity for the remote (#21) work sensing lead of automatic or semi-automatic equipment.

THERMAL PROTECTION LIGHT

The amber thermal protection light will be lit if either of the two protective thermostats have opened. The output power will be disabled but input power will still be applied to the welder.

115 VAC and 42 VAC AUXILIARY POWER AND CONTROL CONNECTIONS

14-Pin Connector

The 14-pin connector receptacle (type MS-3102A-20-27SX) supplies auxiliary power.

42 VAC is available at receptacle pins I and K. A 10 amp circuit breaker protects this circuit.

115 VAC is available at receptacle pins A and J (except on the European model). A 10 amp circuit breaker protects this circuit. Note that the 42 VAC and 115 VAC circuits are electrically isolated from each other.

FRONT VIEW OF 14-PIN CONNECTOR RECEPTACLE

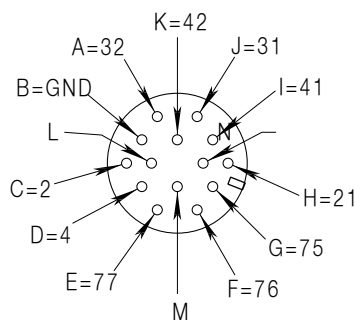

PIN	LEAD NO.	FUNCTION
A	32	115 VAC (Export Model Only)
B	GND	Chassis Connection
C	2	Trigger Circuit
D	4	Trigger Circuit
E	77	Output Control
F	76	Output Control
G	75	Output Control
H	21	Work Connection
I	41	42 VAC
J	31	115 VAC (Export Model Only)
K	42	42 VAC
L	---	---
M	---	---
N	---	---

Terminal Strip Connections

Terminal strip TS2 located behind the hinged control panel on the front of the power source supplies 115 VAC. A 10 amp circuit breaker protects this circuit. This 115 VAC is also available in the 14-pin connector (except on the European model).

Terminal strip TS1 also located behind the hinged control panel allows for connecting of a K775 remote control to terminals 75, 76, and 77.

A chassis ground screw is provided below the terminal strips marked with the symbol \oplus for connecting the automatic equipment grounding wire or remote control grounding wire.

To gain access to the terminal strips simply remove the two #10 sheet metal screws from the top of the welder nameplate. Tilt panel forward so it rests in a horizontal position. See Table above for lead number functions.

220 VAC AUXILIARY POWER FOR WATER COOLER

A Continental European receptacle (220V Schuko type) is located on the rear panel for supplying 220VAC to a water cooler. A 2 amp circuit breaker which is also located on the rear panel protects this circuit from excessive overloads or short circuits.

MACHINE AND CIRCUIT PROTECTION

The power source is thermostatically protected with proximity thermostats against overload or insufficient cooling. One thermostat is located on the nose of the center bottom primary coil and a second thermostat is attached to the lead connecting the secondaries. Both thermostats are connected in series with 2-4 circuit. If the machine is overloaded, the primary thermostat will open, the output will be zero, the amber thermal protection light will be on and the fan will continue to run. The secondary thermostat will open either with an excessive overload or insufficient cooling. The output will be zero, the amber protection light will be on and the fan will continue to run. When the thermostats reset the protection light will be off.

The power source is also protected against overloads on the SCR bridge assembly through the solid state fault protection circuit. This circuit senses an overload on the power source and limits the output to approximately 550 amps by phasing back the SCR's.

Protection is provided to protect the circuitry from accidental grounds. If leads 75, 76, or 77 are accidentally "grounded" to the positive output lead, the output will be reduced to a low value, thus preventing any damage to the machine. If the ground occurs between 75, 76, 77 and the negative output lead, one of the PC board electronic "self-restoring" fuses will blow, preventing any machine damage. After the ground is cleared, the fuses automatically reset within a few seconds.

MAINTENANCE

WARNING



ELECTRIC SHOCK can kill.

- Have an electrician install and service this equipment.
- Turn the input power off at the fuse box before working on equipment.
- Do not touch electrically hot parts.

Routine Maintenance

1. The fan motor has sealed bearings which require no service.
2. In extremely dusty locations, dirt may clog the air channels causing the welder to run hot. Blow out the machine at regular intervals.
3. In extremely dusty locations, dirt may accumulate on the remote control terminal strip. Wipe or blow this terminal strip off at regular intervals. This is particularly important in damp locations.

TROUBLESHOOTING

HOW TO USE TROUBLESHOOTING GUIDE

WARNING

Service and Repair should only be performed by Lincoln Electric Factory Trained Personnel. Unauthorized repairs performed on this equipment may result in danger to the technician and machine operator and will invalidate your factory warranty. For your safety and to avoid Electrical Shock, please observe all safety notes and precautions detailed throughout this manual.

This Troubleshooting Guide is provided to help you locate and repair possible machine malfunctions. Simply follow the three-step procedure listed below.

Step 1. LOCATE PROBLEM (SYMPTOM).

Look under the column labeled “PROBLEM (SYMPTOMS)”. This column describes possible symptoms that the machine may exhibit. Find the listing that best describes the symptom that the machine is exhibiting.

Step 2. POSSIBLE CAUSE.

The second column labeled “POSSIBLE CAUSE” lists the obvious external possibilities that may contribute to the machine symptom.

Step 3. RECOMMENDED COURSE OF ACTION

This column provides a course of action for the Possible Cause, generally it states to contact your local Lincoln Authorized Field Service Facility.

If you do not understand or are unable to perform the Recommended Course of Action safely, contact your local Lincoln Authorized Field Service Facility.

CAUTION

If for any reason you do not understand the test procedures or are unable to perform the tests/repairs safely, contact your **Local Lincoln Authorized Field Service Facility** for technical troubleshooting assistance before you proceed.

TROUBLESHOOTING GUIDE

Trouble	Cause	What To Do
Input contactor (CR1 chatters).	<ol style="list-style-type: none"> 1. Faulty input contactor (CR1). 2. Low line voltage. 	<ol style="list-style-type: none"> 1. Repair or replace. 2. Check input power.
Machine input contactor does not operate.	<ol style="list-style-type: none"> 1. Supply line fuse blown. 2. Contactor power circuit dead. 3. Broken power lead. 4. Wrong input voltage. 5. Open input contactor coil. 6. POWER "I/O" switch (S1) not closing. 	<ol style="list-style-type: none"> 1. Replace if blown - look for reason first. 2. Check control transformer T2 and associated leads. 3. Check input voltage at contactor. 4. Check voltage against instructions. 5. Replace coil. 6. Replace switch.
Machine input contactor operates, but no output when trying to weld.	<ol style="list-style-type: none"> 1. Circuit between #2 (C) and #4 (D) is not being closed. 2. Electrode or work lead loose or broken. 3. Open main transformer (T1) primary or secondary circuit. 4. Defective Control PC Board. 5. Primary or secondary thermostats open. 	<ol style="list-style-type: none"> 1. Make sure trigger circuit is being closed. 2. Repair connection. 3. Repair 4. Replace. See Procedure for Replacing PC Boards. 5. Amber thermal protection light is on: Check for overheating; make sure fan is operating and there is no obstruction to free air flow.
Machine has minimum output and no control.	<ol style="list-style-type: none"> 1. Terminals 75, 76, or 77 grounded to <u>positive</u> output. 	<ol style="list-style-type: none"> 1. Check 75, 76, or 77 for ground to positive output circuit. Nearly zero ohms to ground indicates a grounded circuit. A value greater than a few thousand ohms is normal. Self-restoring fuses on PC Board automatically reset within a few seconds after ground is cleared.
Machine has high output and no control.	<ol style="list-style-type: none"> 1. Terminals 75, 76, or 77 grounded to <u>negative</u> output. 	<ol style="list-style-type: none"> 1. Check 75, 76, or 77 for ground to negative output circuit. Nearly zero ohms to ground indicates a grounded circuit. A value greater than a few thousand ohms is normal. Self-restoring fuses on PC Board automatically reset within a few seconds after ground is cleared.

Trouble	Cause	What To Do
Machine has low output and no control.	<ol style="list-style-type: none"> 1. Output Control "Local-Remote" switch (S2) in wrong position. 2. Output Control switch faulty. 3. Open in feedback circuitry. 4. Faulty Control PC Board. 5. Output control potentiometer circuit open (Lead 75). 	<ol style="list-style-type: none"> 1. Check position of switch. 2. Check switch and replace if faulty. 3. Check wiring and control PC Board wiring harness plugs. 4. Replace. See Procedure for Replacing PC Boards. 5. Check and replace potentiometer if faulty. Check wiring of Lead #75.
Machine does not have maximum output.	<ol style="list-style-type: none"> 1. One input fuse blown. 2. One phase of main transformer open. 3. Faulty Control PC Board. 4. Output control potentiometer defective. 5. Output control potentiometer Leads 210, 211, or 75 open. 	<ol style="list-style-type: none"> 1. Check and replace if blown after checking for reason for blown fuse. 2. Check for open and repair. 3. Replace. See Procedure for Replacing PC Boards. 4. Check and replace if faulty. 5. Check and repair broken leads.
Machine will not shut off.	<ol style="list-style-type: none"> 1. Input contactor contacts frozen. 2. Defective Power "I/O" switch, (S1). 	<ol style="list-style-type: none"> 1. Check and replace if necessary. 2. Replace.
Variable or sluggish welding arc.	<ol style="list-style-type: none"> 1. Poor work or electrode connection. 2. Welding leads too small. 3. Welding current or voltage too low. 4. Defective main SCR bridge. 	<ol style="list-style-type: none"> 1. Check and clean all connections. 2. Check table in instruction manual. 3. Check procedures for recommended settings. 4. Check and replace if defective.
Output control not functioning on the machine.	<ol style="list-style-type: none"> 1. Output Control "Local-Remote" switch (S2) in wrong position. 2. Faulty Output Control switch. 3. Faulty Output Control potentiometer. 4. Leads or connections open in control circuit. 5. Faulty Control PC Board. 	<ol style="list-style-type: none"> 1. Place switch in "Local". 2. Check and replace if found faulty. 3. Check and replace if found faulty. 4. Check lead continuity and connections for an open and repair if necessary. 5. Replace. See Procedure for Replacing PC Boards.

Trouble	Cause	What To Do
Output control not functioning on "Remote" control.	<ol style="list-style-type: none"> 1. Output Control switch in wrong position. 2. Faulty Output Control switch. 3. Faulty remote control potentiometer. 4. Leads or connections open in control circuit. 5. Faulty Control PC Board. 	<ol style="list-style-type: none"> 1. Place switch in "Remote". 2. Check and replace if found faulty. 3. Check and replace if found faulty. 4. Check all leads and connections, internal or remote, for continuity; repair if necessary. 5. Replace. See Procedure for Replacing PC Boards.
Poor arc striking with semiautomatic or automatic wire feeders.	<ol style="list-style-type: none"> 1. Poor work connection. 2. Improper procedures. 3. Defective Control PC Board. 	<ol style="list-style-type: none"> 1. Work connection must be adequate for application. 2. Adjust procedures for improved starting. 3. Replace. See Procedure for Replacing PC Boards.
Poor arc characteristics.	<ol style="list-style-type: none"> 1. Defective Control PC Board. 2. Capacitor(s) in output circuit failed. A failure is indicated if the small vent plug on top of a capacitor is raised or blown out. 	<ol style="list-style-type: none"> 1. Replace. See Procedure for Replacing PC Boards. 2. Replace entire bank of capacitors. Do <u>not</u> replace individual capacitors. <p>WARNING: The liquid electrolyte in these capacitors is toxic. Avoid contact with any portion of your body. Clean up vented electrolyte using rubber gloves and a water dampened cloth. Any electrolyte which gets on skin, clean with soap and water.</p>

Procedure for Replacing PC Boards

WARNING



ELECTRIC SHOCK can kill.

- Have an electrician install and service this equipment.
 - Turn the input power off at the fuse box before working on equipment.
- Do not touch electrically hot parts.

When a PC board is suspected to be defective, the following procedure must be followed:

1. Visually inspect the PC board. If the board has fuses, check to see if any are blown. Are any of the components damaged? Is a conductor on the back side of the board damaged? If electrical damage is visible on the PC board, inspect the machine wiring for grounds or shorts to avoid damaging a new PC board. Install a new PC board only after a visual inspection of the PC board and machine wiring is satisfactory.
2. If the problem is remedied by a new PC board, install the old PC board and see if the problem still exists. If the problem does not return with the old board:
 - a. Check the PC board harness plug and PC board plug for contamination, corrosion or oversize.
 - b. Check leads in the harness for loose connections.

CONNECTING THE REMOTE CONTROL TO THE MACHINE

Extreme caution must be observed when installing or extending the wiring of a remote control. Improper connection of this unit can lead to loss of control and/or poor welding. Only the green lead can and should be grounded to the machine case. When extending the standard remote control, make sure the leads are the same and the splice is waterproof. Be very careful not to ground the cable when in use and don't let the lugs touch against the case.

OUTPUT VOLTAGE

The open circuit voltage of the machine should be adjustable from 10 to 46 volts. If any other condition exists, refer to the Troubleshooting Guide.

FAULT PROTECTION OPERATION

The overload protection circuit, in the Control Board, will limit the welding current (heat) to approximately 550 amps if a short or overload is applied to the machine.

CHECKING SNUBBER PC BOARD

In case of an SCR malfunction or failure, the Snubber PC Board should be checked. Turn the machine off and remove the sides of the machine. Board is mounted on back of the case front.

1. Visually inspect the Board for overheated components or damaged components.

CHECKING OUTPUT CONTROL RHEOSTAT ON MACHINE

Turn machine off ("0" position).

Remove the screws from the hinged control panel and open the panel.

Turn the Output Control switch to "Remote".

Disconnect the harness plug from the Control PC Board.

With an ohmmeter on X1K, connect it to lead 210 and 75 on R4.

Exercise caution to avoid damaging rheostat tabs.

Rotate the Output control rheostat. The resistance reading should be from around zero to 10K ohms. Check the resistance reading between 77 and 75 on the terminal strip. The reading must be 10K ohms. No reading will indicate an open rheostat and a low reading will indicate a shorted or partially shorted rheostat; in either case, replace.

POWER " I/O " SWITCH CHECK

1. Turn off the machine input power ("0" position). S1 has 115 volts across it when the input power is connected.
2. Isolate the switch to be tested by removing all connecting leads.
3. Check to make sure the switch is making open and closed connections with a V.O.M. meter. Put ohmmeter on X1 scale. The meter should read zero resistance with switch "I" and infinite with switch "0".
4. Put the ohmmeter on X1K scale and measure the resistance between the terminal and the case of the machine (touch a self-tapping screw). Reading should be infinite.
5. If either step (3) or step (4) fails, replace the switch.

REMOTE CONTROL CHECK

Disconnect the remote output control and connect an ohmmeter across 75 and 76 and rotate the rheostat in the remote control. The resistance reading should go from zero to 10K ohms. Repeat with ohmmeter across 77 and 76 with same results. Connect ohmmeter across 75 and 77. The reading should be 10K ohms. A lower reading will indicate a shorted or partially shorted rheostat. A very high reading will indicate an open rheostat. In either of the last two cases, replace rheostat. Check cable for any physical damage.

POWER RECTIFIER BRIDGE ASSEMBLY CHECKING PROCEDURE

WARNING



ELECTRIC SHOCK can kill.

- Have an electrician install and service this equipment.
 - Turn the input power off at the fuse box before working on equipment.
- Do not touch electrically hot parts.

1. Bridge and Device Isolation

Disconnect the following, shown in Diagram 1:

- Unplug P3 (G1, G2, G3, and 204) from the Control PC Board.
- Unplug P5 from the Snubber PC Board.
- Secondary leads X1, X2, and X3 from the anodes of the SCR's and cathodes of the diodes.
- Disconnect positive bridge lead from shunt and positive capacitor bank lead and from lug with dual 204 leads.
- Perform following steps 2 and 3. If diodes and SCR's are not shorted, bridge test is completed. If any device appears shorted, disconnect the cathode lead of each diode (4 total) and repeat steps 2 and 3.

2. Power Diode Test

- Establish the polarity of the ohmmeter leads and set to X10 scale.
- Connect the ohmmeter positive lead to anode and negative lead to the cathode.
- Reverse the leads of the ohmmeter from Step b.
- A shorted diode will indicate zero or an equally low

resistance in both directions. An open diode will have an infinite or high resistance in both directions and a good diode will have a low resistance in Step b. and a much higher resistance in Step c.

3. Power Silicon Controlled Rectifier Test

The SCR must be mounted in the heat sink when making this test.

- Connect the ohmmeter (set to the X10 scale) leads to the anode and cathode.
- Reverse the leads of the ohmmeter from Step a.
- A shorted SCR will indicate zero or an equally low resistance in one or both directions.
- Establish the polarity of the ohmmeter. Connect the positive lead to the gate and the negative lead to the cathode.
- An open gate circuit will have an infinite or high resistance. A good gate circuit will read a low resistance, but not zero ohms. If gate circuit reads zero ohms, check gate harness for shorts between gate leads and 204 before replacing SCR.

TWIST-MATE WELDING CABLE PLUG INSTALLATION INSTRUCTIONS

	WARNING: ELECTRIC SHOCK CAN KILL
TURN THE POWER SWITCH OF THE WELDING POWER SOURCE "OFF" BEFORE INSTALLING PLUGS ON CABLES OR WHEN CONNECTING OR DISCONNECTING PLUGS TO WELDING POWER SOURCE.	

1. CHECK THAT THE CONNECTOR BOOT IS MARKED FOR THE APPROPRIATE CABLE SIZE PER TABLE BELOW; AND SKIN CABLE JACKET TO LENGTH SPECIFIED:

BOOT MARKING	AMERICAN (EUROPEAN) RANGE CABLE SIZE	CABLE SKIN LENGTH
35-50	#2-#1 (35-50 mm ³)	1 INCH (25.4mm)
50-70	1/0-2/0 (50-70 mm ³)	1 INCH (25.4mm)
70-95	2/0-3/0 (70-95 mm ³)	1.5 INCH (38.1mm)

2. If necessary, trim cable end of boot at groove(s) to match cable diameter. Boot must fit tightly enough to seal around outside diameter of cable. NOTE: Some boots are designed to accommodate different cable diameters without trimming. These boots do not have grooves at the cable end. Soap or other non petroleum based lubricant will help to slide the boot over the cable.
3. Slide rubber boot onto cable end.

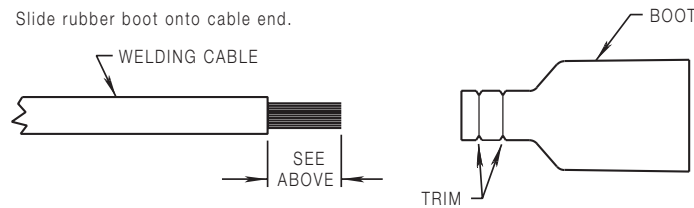

4. Slide the copper tube into the brass plug.
5. Insert cable into copper tube.

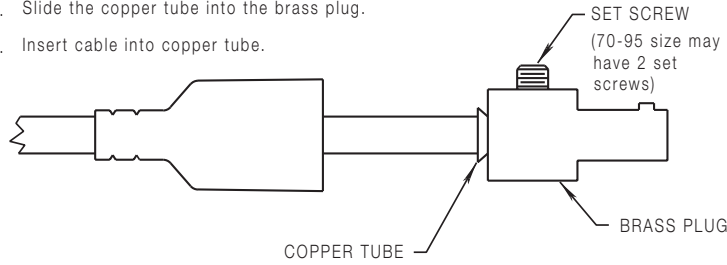

6. Tighten set screw(s) to collapse copper tube. Screw(s) must apply firm pressure against welding cable. The top of the set screw(s) will be nearly flush or below the surface of the brass plug after tightening.
7. Slide rubber boot over brass plug. The rubber boot must be positioned to completely cover all electrical surfaces after the plug is locked into the receptacle.

9-20-91J
S18737

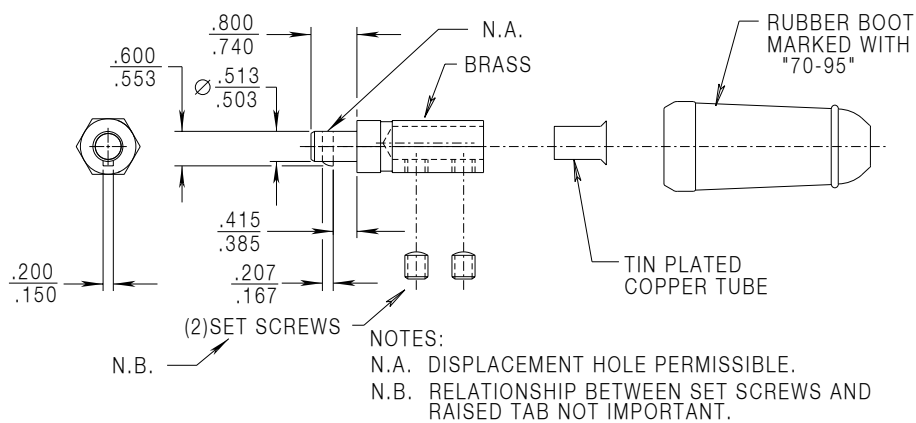

9-20-91J
M15479-1

POWER RECTIFIER BRIDGE DIAGRAM 1

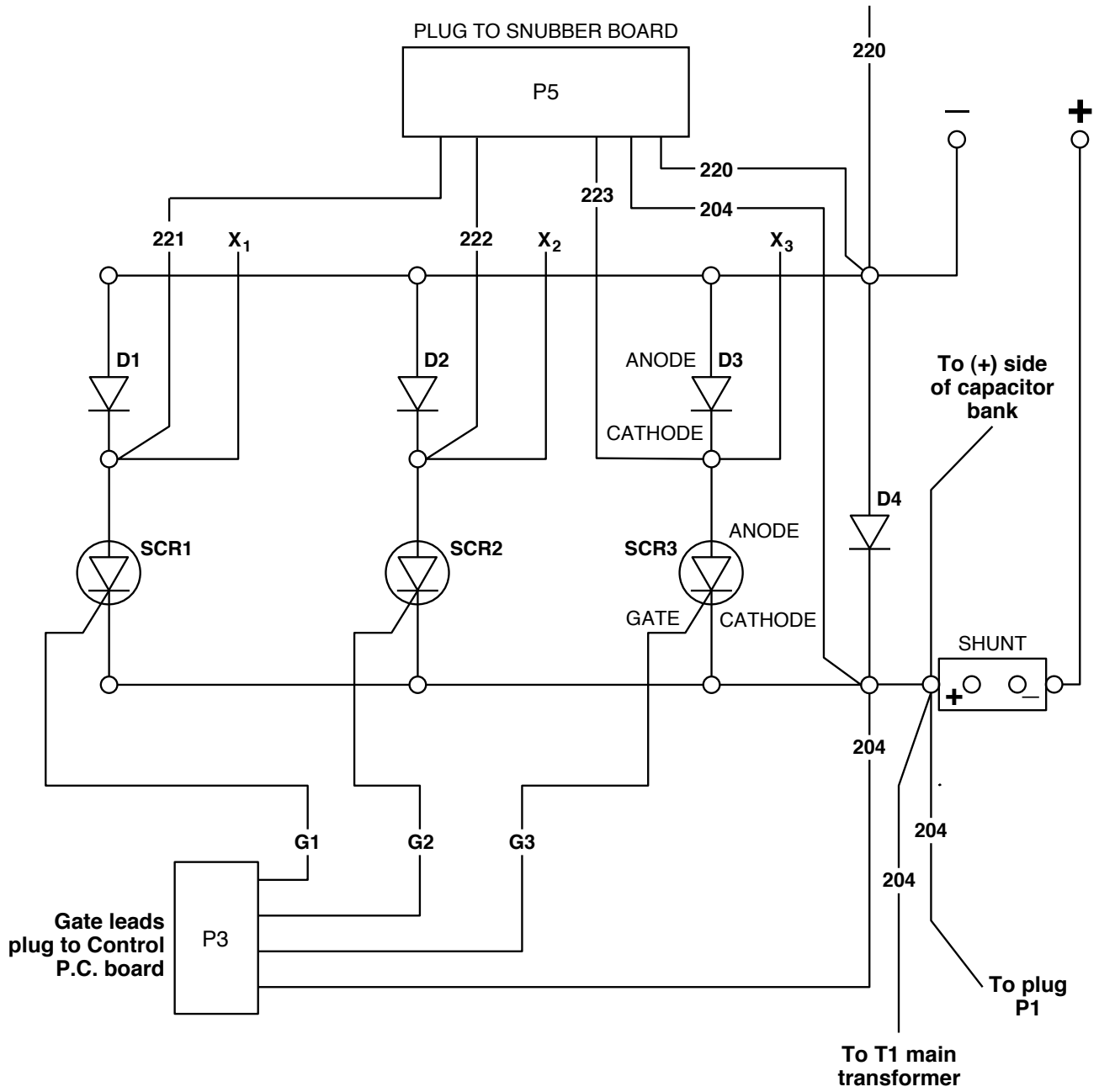

CV-400 / CV 500 - I WIRING DIAGRAM

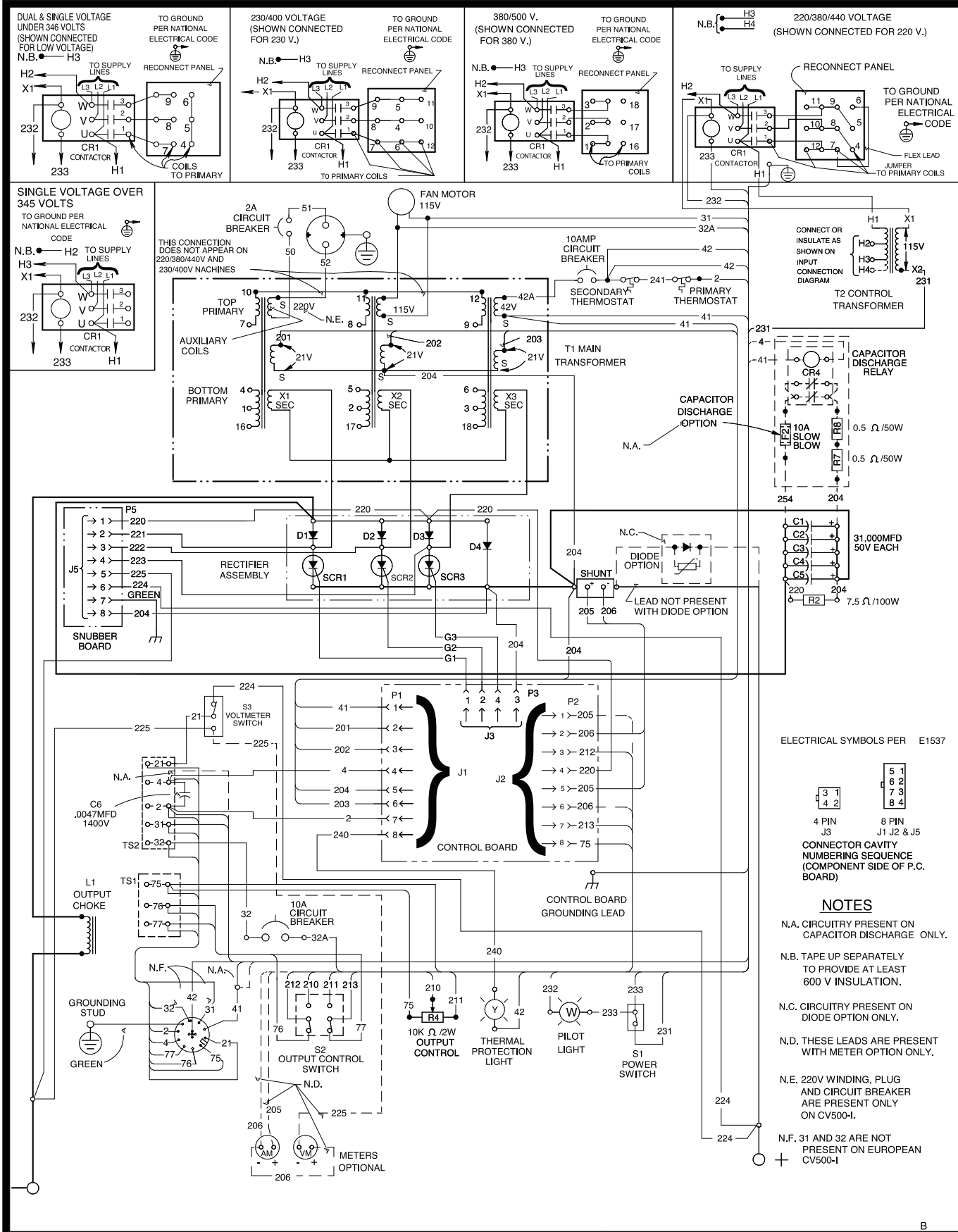

NOTE: This diagram is for reference only. It may not be accurate for all machines covered by this manual. The specific diagram for a particular code is pasted inside the machine on one of the enclosure panels. If the diagram is illegible, write to the Service Department for a replacement. Give the equipment code number.

L9269

NOTES

NOTES

			
WARNING	<ul style="list-style-type: none"> Do not touch electrically live parts or electrode with skin or wet clothing. Insulate yourself from work and ground. 	<ul style="list-style-type: none"> Keep flammable materials away. 	<ul style="list-style-type: none"> Wear eye, ear and body protection.
Spanish AVISO DE PRECAUCION	<ul style="list-style-type: none"> No toque las partes o los electrodos bajo carga con la piel o ropa mojada. Aíslese del trabajo y de la tierra. 	<ul style="list-style-type: none"> Mantenga el material combustible fuera del área de trabajo. 	<ul style="list-style-type: none"> Protéjase los ojos, los oídos y el cuerpo.
French ATTENTION	<ul style="list-style-type: none"> Ne laissez ni la peau ni des vêtements mouillés entrer en contact avec des pièces sous tension. Isolez-vous du travail et de la terre. 	<ul style="list-style-type: none"> Gardez à l'écart de tout matériel inflammable. 	<ul style="list-style-type: none"> Protégez vos yeux, vos oreilles et votre corps.
German WARNUNG	<ul style="list-style-type: none"> Berühren Sie keine stromführenden Teile oder Elektroden mit Ihrem Körper oder feuchter Kleidung! Isolieren Sie sich von den Elektroden und dem Erdboden! 	<ul style="list-style-type: none"> Entfernen Sie brennbares Material! 	<ul style="list-style-type: none"> Tragen Sie Augen-, Ohren- und Körperschutz!
Portuguese ATENÇÃO	<ul style="list-style-type: none"> Não toque partes elétricas e electrodos com a pele ou roupa molhada. Isole-se da peça e terra. 	<ul style="list-style-type: none"> Mantenha inflamáveis bem guardados. 	<ul style="list-style-type: none"> Use proteção para a vista, ouvido e corpo.
Japanese 注意事項	<ul style="list-style-type: none"> ● 通電中の電気部品、又は溶材にヒフやぬれた布で触れないこと。 ● 施工物やアースから身体が絶縁されている様にして下さい。 	<ul style="list-style-type: none"> ● 燃えやすいものの側での溶接作業は絶対にしてはなりません。 	<ul style="list-style-type: none"> ● 目、耳及び身体に保護具をして下さい。
Chinese 警告	<ul style="list-style-type: none"> ● 皮肤或湿衣物切勿接触带电部件及焊条。 ● 使你自已与地面和工件绝缘。 	<ul style="list-style-type: none"> ● 把一切易燃物品移离工作场所。 	<ul style="list-style-type: none"> ● 佩戴眼、耳及身体劳动保护用具。
Korean 위험	<ul style="list-style-type: none"> ● 전도체나 용접봉을 젖은 헝겍 또는 피부로 절대 접촉치 마십시오. ● 모재와 접지를 접촉치 마십시오. 	<ul style="list-style-type: none"> ● 인화성 물질을 접근시키지 마십시오. 	<ul style="list-style-type: none"> ● 눈, 귀와 몸에 보호장구를 착용하십시오.
Arabic تحذير	<ul style="list-style-type: none"> ● لا تلمس الاجزاء التي يسري فيها التيار الكهربائي أو الألكترود بجلد الجسم أو بالملايس المبللة بالماء. ● وضع عازلا على جسمك خلال العمل. 	<ul style="list-style-type: none"> ● ضع المواد القابلة للاشتعال في مكان بعيد. 	<ul style="list-style-type: none"> ● ضع أدوات وملابس واقية على عينيك وأذنيك وجسمك.

READ AND UNDERSTAND THE MANUFACTURER'S INSTRUCTION FOR THIS EQUIPMENT AND THE CONSUMABLES TO BE USED AND FOLLOW YOUR EMPLOYER'S SAFETY PRACTICES.

SE RECOMIENDA LEER Y ENTENDER LAS INSTRUCCIONES DEL FABRICANTE PARA EL USO DE ESTE EQUIPO Y LOS CONSUMIBLES QUE VA A UTILIZAR, SIGA LAS MEDIDAS DE SEGURIDAD DE SU SUPERVISOR.

LISEZ ET COMPRENEZ LES INSTRUCTIONS DU FABRICANT EN CE QUI REGARDE CET EQUIPMENT ET LES PRODUITS A ETRE EMPLOYES ET SUIVEZ LES PROCEDURES DE SECURITE DE VOTRE EMPLOYEUR.

LESEN SIE UND BEFOLGEN SIE DIE BETRIEBSANLEITUNG DER ANLAGE UND DEN ELEKTRODENEINSATZ DES HERSTELLERS. DIE UNFALLVERHÜTUNGSVORSCHRIFTEN DES ARBEITGEBERS SIND EBENFALLS ZU BEACHTEN.

			
<ul style="list-style-type: none"> • Keep your head out of fumes. • Use ventilation or exhaust to remove fumes from breathing zone. 	<ul style="list-style-type: none"> • Turn power off before servicing. 	<ul style="list-style-type: none"> • Do not operate with panel open or guards off. 	WARNING
<ul style="list-style-type: none"> • Los humos fuera de la zona de respiración. • Mantenga la cabeza fuera de los humos. Utilice ventilación o aspiración para gases. 	<ul style="list-style-type: none"> • Desconectar el cable de alimentación de poder de la máquina antes de iniciar cualquier servicio. 	<ul style="list-style-type: none"> • No operar con panel abierto o guardas quitadas. 	Spanish AVISO DE PRECAUCION
<ul style="list-style-type: none"> • Gardez la tête à l'écart des fumées. • Utilisez un ventilateur ou un aspirateur pour ôter les fumées des zones de travail. 	<ul style="list-style-type: none"> • Débranchez le courant avant l'entretien. 	<ul style="list-style-type: none"> • N'opérez pas avec les panneaux ouverts ou avec les dispositifs de protection enlevés. 	French ATTENTION
<ul style="list-style-type: none"> • Vermeiden Sie das Einatmen von Schweißrauch! • Sorgen Sie für gute Be- und Entlüftung des Arbeitsplatzes! 	<ul style="list-style-type: none"> • Strom vor Wartungsarbeiten abschalten! (Netzstrom völlig öffnen; Maschine anhalten!) 	<ul style="list-style-type: none"> • Anlage nie ohne Schutzgehäuse oder Innenschutzverkleidung in Betrieb setzen! 	German WARNUNG
<ul style="list-style-type: none"> • Mantenha seu rosto da fumaça. • Use ventilação e exaustão para remover fumo da zona respiratória. 	<ul style="list-style-type: none"> • Não opere com as tampas removidas. • Desligue a corrente antes de fazer serviço. • Não toque as partes elétricas nuas. 	<ul style="list-style-type: none"> • Mantenha-se afastado das partes moventes. • Não opere com os painéis abertos ou guardas removidas. 	Portuguese ATENÇÃO
<ul style="list-style-type: none"> ● ヒュームから頭を離すようにして下さい。 ● 換気や排煙に十分留意して下さい。 	<ul style="list-style-type: none"> ● メンテナンス・サービスに取りかかる際には、まず電源スイッチを必ず切ってください。 	<ul style="list-style-type: none"> ● パネルやカバーを取り外したまま機械操作をしないで下さい。 	Japanese 注意事項
<ul style="list-style-type: none"> ● 頭部遠離煙霧。 ● 在呼吸區使用通風或排風器除煙。 	<ul style="list-style-type: none"> ● 維修前切斷電源。 	<ul style="list-style-type: none"> ● 儀表板打開或沒有安全罩時不準作業。 	Chinese 警告
<ul style="list-style-type: none"> ● 얼굴로부터 용접가스를 멀리하십시오. ● 호흡지역으로부터 용접가스를 제거하기 위해 가스제거기나 통풍기를 사용하십시오. 	<ul style="list-style-type: none"> ● 보수전에 전원을 차단하십시오. 	<ul style="list-style-type: none"> ● 판넬이 열린 상태로 작동치 마십시오. 	Korean 위험
<ul style="list-style-type: none"> ● ابعدها رأسك بعيداً عن الدخان. ● استعمل التهوية أو جهاز ضغط الدخان للخارج لكي تبعد الدخان عن المنطقة التي تتنفس فيها. 	<ul style="list-style-type: none"> ● اقطع التيار الكهربائي قبل القيام بأية صيانة. 	<ul style="list-style-type: none"> ● لا تشغيل هذا الجهاز اذا كانت الاغطية الحديدية الواقية ليست عليه. 	Arabic تحذير

LEIA E COMPREENDA AS INSTRUÇÕES DO FABRICANTE PARA ESTE EQUIPAMENTO E AS PARTES DE USO, E SIGA AS PRÁTICAS DE SEGURANÇA DO EMPREGADOR.

使う機械や溶材のメーカーの指示書をよく読み、まず理解して下さい。そして貴社の安全規定に従って下さい。

請詳細閱讀並理解製造廠提供的說明以及應該使用的銀焊材料，並請遵守貴方的有閣勞動保護規定。

이 제품에 동봉된 작업지침서를 숙지하시고 귀사의 작업자 안전수칙을 준수하시기 바랍니다.

اقرأ بتمعن وافهم تعليمات المصنع المنتج لهذه المعدات والمواد قبل استعمالها واتبع تعليمات الوقاية لصاحب العمل.



• World's Leader in Welding and Cutting Products •

• Sales and Service through Subsidiaries and Distributors Worldwide •

Cleveland, Ohio 44117-1199 U.S.A. TEL: 216.481.8100 FAX: 216.486.1751 WEB SITE: www.lincolnelectric.com

Download from Www.Somanuals.com. All Manuals Search And Download.

Free Manuals Download Website

<http://myh66.com>

<http://usermanuals.us>

<http://www.somanuals.com>

<http://www.4manuals.cc>

<http://www.manual-lib.com>

<http://www.404manual.com>

<http://www.luxmanual.com>

<http://aubethermostatmanual.com>

Golf course search by state

<http://golfingnear.com>

Email search by domain

<http://emailbydomain.com>

Auto manuals search

<http://auto.somanuals.com>

TV manuals search

<http://tv.somanuals.com>