

UNDER-COOLER CART

For use with machines having Code Numbers: **10808, 11068**

Safety Depends on You

Lincoln arc welding and cutting equipment is designed and built with safety in mind. However, your overall safety can be increased by proper installation ... and thoughtful operation on your part. **DO NOT INSTALL, OPERATE OR REPAIR THIS EQUIPMENT WITHOUT READING THIS MANUAL AND THE SAFETY PRECAUTIONS CONTAINED THROUGHOUT.** And, most importantly, think before you act and be careful.

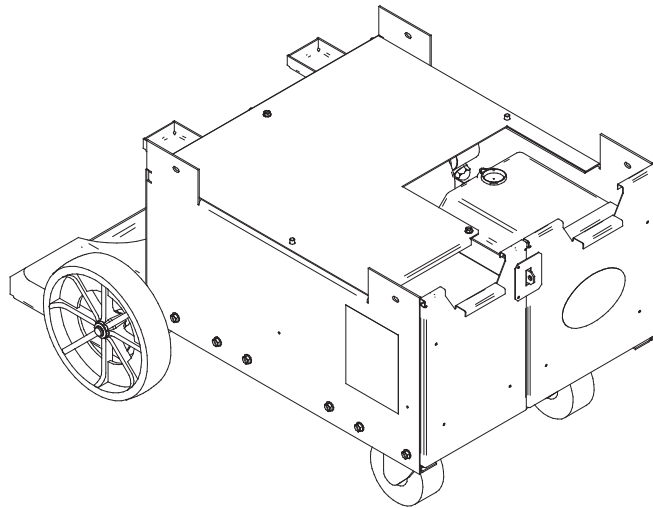

IP 21S

NTRL/C

OPERATOR'S MANUAL



LINCOLN[®]
ELECTRIC

Copyright © 2004 Lincoln Global Inc.

• World's Leader in Welding and Cutting Products •

• Sales and Service through Subsidiaries and Distributors Worldwide •

Cleveland, Ohio 44117-1199 U.S.A. TEL: 216.481.8100 FAX: 216.486.1751 WEB SITE: www.lincolnelectric.com

Download from Www.Somanuals.com. All Manuals Search And Download.

⚠ WARNING

⚠ CALIFORNIA PROPOSITION 65 WARNINGS ⚠

Diesel engine exhaust and some of its constituents are known to the State of California to cause cancer, birth defects, and other reproductive harm.

The Above For Diesel Engines

The engine exhaust from this product contains chemicals known to the State of California to cause cancer, birth defects, or other reproductive harm.

The Above For Gasoline Engines

ARC WELDING CAN BE HAZARDOUS. PROTECT YOURSELF AND OTHERS FROM POSSIBLE SERIOUS INJURY OR DEATH. KEEP CHILDREN AWAY. PACEMAKER WEARERS SHOULD CONSULT WITH THEIR DOCTOR BEFORE OPERATING.

Read and understand the following safety highlights. For additional safety information, it is strongly recommended that you purchase a copy of "Safety in Welding & Cutting - ANSI Standard Z49.1" from the American Welding Society, P.O. Box 351040, Miami, Florida 33135 or CSA Standard W117.2-1974. A Free copy of "Arc Welding Safety" booklet E205 is available from the Lincoln Electric Company, 22801 St. Clair Avenue, Cleveland, Ohio 44117-1199.

BE SURE THAT ALL INSTALLATION, OPERATION, MAINTENANCE AND REPAIR PROCEDURES ARE PERFORMED ONLY BY QUALIFIED INDIVIDUALS.



FOR ENGINE powered equipment.

1.a. Turn the engine off before troubleshooting and maintenance work unless the maintenance work requires it to be running.



1.b. Operate engines in open, well-ventilated areas or vent the engine exhaust fumes outdoors.



1.c. Do not add the fuel near an open flame welding arc or when the engine is running. Stop the engine and allow it to cool before refueling to prevent spilled fuel from vaporizing on contact with hot engine parts and igniting. Do not spill fuel when filling tank. If fuel is spilled, wipe it up and do not start engine until fumes have been eliminated.

1.d. Keep all equipment safety guards, covers and devices in position and in good repair. Keep hands, hair, clothing and tools away from V-belts, gears, fans and all other moving parts when starting, operating or repairing equipment.

1.e. In some cases it may be necessary to remove safety guards to perform required maintenance. Remove guards only when necessary and replace them when the maintenance requiring their removal is complete. Always use the greatest care when working near moving parts.



1.f. Do not put your hands near the engine fan. Do not attempt to override the governor or idler by pushing on the throttle control rods while the engine is running.

1.g. To prevent accidentally starting gasoline engines while turning the engine or welding generator during maintenance work, disconnect the spark plug wires, distributor cap or magneto wire as appropriate.



1.h. To avoid scalding, do not remove the radiator pressure cap when the engine is hot.



ELECTRIC AND MAGNETIC FIELDS may be dangerous

2.a. Electric current flowing through any conductor causes localized Electric and Magnetic Fields (EMF). Welding current creates EMF fields around welding cables and welding machines

2.b. EMF fields may interfere with some pacemakers, and welders having a pacemaker should consult their physician before welding.

2.c. Exposure to EMF fields in welding may have other health effects which are now not known.

2.d. All welders should use the following procedures in order to minimize exposure to EMF fields from the welding circuit:

2.d.1. Route the electrode and work cables together - Secure them with tape when possible.

2.d.2. Never coil the electrode lead around your body.

2.d.3. Do not place your body between the electrode and work cables. If the electrode cable is on your right side, the work cable should also be on your right side.

2.d.4. Connect the work cable to the workpiece as close as possible to the area being welded.

2.d.5. Do not work next to welding power source.

Mar '95



ELECTRIC SHOCK can kill.

- 3.a. The electrode and work (or ground) circuits are electrically "hot" when the welder is on. Do not touch these "hot" parts with your bare skin or wet clothing. Wear dry, hole-free gloves to insulate hands.
- 3.b. Insulate yourself from work and ground using dry insulation. Make certain the insulation is large enough to cover your full area of physical contact with work and ground.
- In addition to the normal safety precautions, if welding must be performed under electrically hazardous conditions (in damp locations or while wearing wet clothing; on metal structures such as floors, gratings or scaffolds; when in cramped positions such as sitting, kneeling or lying, if there is a high risk of unavoidable or accidental contact with the workpiece or ground) use the following equipment:**
- Semiautomatic DC Constant Voltage (Wire) Welder.
 - DC Manual (Stick) Welder.
 - AC Welder with Reduced Voltage Control.
- 3.c. In semiautomatic or automatic wire welding, the electrode, electrode reel, welding head, nozzle or semiautomatic welding gun are also electrically "hot".
- 3.d. Always be sure the work cable makes a good electrical connection with the metal being welded. The connection should be as close as possible to the area being welded.
- 3.e. Ground the work or metal to be welded to a good electrical (earth) ground.
- 3.f. Maintain the electrode holder, work clamp, welding cable and welding machine in good, safe operating condition. Replace damaged insulation.
- 3.g. Never dip the electrode in water for cooling.
- 3.h. Never simultaneously touch electrically "hot" parts of electrode holders connected to two welders because voltage between the two can be the total of the open circuit voltage of both welders.
- 3.i. When working above floor level, use a safety belt to protect yourself from a fall should you get a shock.
- 3.j. Also see Items 6.c. and 8.



ARC RAYS can burn.

- 4.a. Use a shield with the proper filter and cover plates to protect your eyes from sparks and the rays of the arc when welding or observing open arc welding. Headshield and filter lens should conform to ANSI Z87.1 standards.
- 4.b. Use suitable clothing made from durable flame-resistant material to protect your skin and that of your helpers from the arc rays.
- 4.c. Protect other nearby personnel with suitable, non-flammable screening and/or warn them not to watch the arc nor expose themselves to the arc rays or to hot spatter or metal.



FUMES AND GASES can be dangerous.

- 5.a. Welding may produce fumes and gases hazardous to health. Avoid breathing these fumes and gases. When welding, keep your head out of the fume. Use enough ventilation and/or exhaust at the arc to keep fumes and gases away from the breathing zone. **When welding with electrodes which require special ventilation such as stainless or hard facing (see instructions on container or MSDS) or on lead or cadmium plated steel and other metals or coatings which produce highly toxic fumes, keep exposure as low as possible and below Threshold Limit Values (TLV) using local exhaust or mechanical ventilation. In confined spaces or in some circumstances, outdoors, a respirator may be required. Additional precautions are also required when welding on galvanized steel.**
- 5.b. Do not weld in locations near chlorinated hydrocarbon vapors coming from degreasing, cleaning or spraying operations. The heat and rays of the arc can react with solvent vapors to form phosgene, a highly toxic gas, and other irritating products.
- 5.c. Shielding gases used for arc welding can displace air and cause injury or death. Always use enough ventilation, especially in confined areas, to insure breathing air is safe.
- 5.d. Read and understand the manufacturer's instructions for this equipment and the consumables to be used, including the material safety data sheet (MSDS) and follow your employer's safety practices. MSDS forms are available from your welding distributor or from the manufacturer.
- 5.e. Also see item 1.b.

Mar '95



WELDING SPARKS can cause fire or explosion.

6.a. Remove fire hazards from the welding area. If this is not possible, cover them to prevent the welding sparks from starting a fire.

Remember that welding sparks and hot materials from welding can easily go through small cracks and openings to adjacent areas. Avoid welding near hydraulic lines. Have a fire extinguisher readily available.

- 6.b. Where compressed gases are to be used at the job site, special precautions should be used to prevent hazardous situations. Refer to "Safety in Welding and Cutting" (ANSI Standard Z49.1) and the operating information for the equipment being used.
- 6.c. When not welding, make certain no part of the electrode circuit is touching the work or ground. Accidental contact can cause overheating and create a fire hazard.
- 6.d. Do not heat, cut or weld tanks, drums or containers until the proper steps have been taken to insure that such procedures will not cause flammable or toxic vapors from substances inside. They can cause an explosion even though they have been "cleaned". For information, purchase "Recommended Safe Practices for the Preparation for Welding and Cutting of Containers and Piping That Have Held Hazardous Substances", AWS F4.1 from the American Welding Society (see address above).
- 6.e. Vent hollow castings or containers before heating, cutting or welding. They may explode.
- 6.f. Sparks and spatter are thrown from the welding arc. Wear oil free protective garments such as leather gloves, heavy shirt, cuffless trousers, high shoes and a cap over your hair. Wear ear plugs when welding out of position or in confined places. Always wear safety glasses with side shields when in a welding area.
- 6.g. Connect the work cable to the work as close to the welding area as practical. Work cables connected to the building framework or other locations away from the welding area increase the possibility of the welding current passing through lifting chains, crane cables or other alternate circuits. This can create fire hazards or overheat lifting chains or cables until they fail.
- 6.h. Also see item 1.c.

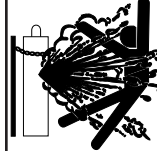

CYLINDER may explode if damaged.

7.a. Use only compressed gas cylinders containing the correct shielding gas for the process used and properly operating regulators designed for the gas and pressure used. All hoses, fittings, etc. should be suitable for the application and maintained in good condition.

- 7.b. Always keep cylinders in an upright position securely chained to an undercarriage or fixed support.
- 7.c. Cylinders should be located:
 - Away from areas where they may be struck or subjected to physical damage.
 - A safe distance from arc welding or cutting operations and any other source of heat, sparks, or flame.
- 7.d. Never allow the electrode, electrode holder or any other electrically "hot" parts to touch a cylinder.
- 7.e. Keep your head and face away from the cylinder valve outlet when opening the cylinder valve.
- 7.f. Valve protection caps should always be in place and hand tight except when the cylinder is in use or connected for use.
- 7.g. Read and follow the instructions on compressed gas cylinders, associated equipment, and CGA publication P-1, "Precautions for Safe Handling of Compressed Gases in Cylinders," available from the Compressed Gas Association 1235 Jefferson Davis Highway, Arlington, VA 22202.



FOR ELECTRICALLY powered equipment.

- 8.a. Turn off input power using the disconnect switch at the fuse box before working on the equipment.
- 8.b. Install equipment in accordance with the U.S. National Electrical Code, all local codes and the manufacturer's recommendations.
- 8.c. Ground the equipment in accordance with the U.S. National Electrical Code and the manufacturer's recommendations.

Mar '95

PRÉCAUTIONS DE SÛRETÉ

Pour votre propre protection lire et observer toutes les instructions et les précautions de sûreté spécifiques qui paraissent dans ce manuel aussi bien que les précautions de sûreté générales suivantes:

Sûreté Pour Soudage A L'Arc

1. Protégez-vous contre la secousse électrique:
 - a. Les circuits à l'électrode et à la pièce sont sous tension quand la machine à souder est en marche. Eviter toujours tout contact entre les parties sous tension et la peau nue ou les vêtements mouillés. Porter des gants secs et sans trous pour isoler les mains.
 - b. Faire très attention de bien s'isoler de la masse quand on soude dans des endroits humides, ou sur un plancher métallique ou des grilles métalliques, principalement dans les positions assis ou couché pour lesquelles une grande partie du corps peut être en contact avec la masse.
 - c. Maintenir le porte-électrode, la pince de masse, le câble de soudage et la machine à souder en bon et sûr état de fonctionnement.
 - d. Ne jamais plonger le porte-électrode dans l'eau pour le refroidir.
 - e. Ne jamais toucher simultanément les parties sous tension des porte-électrodes connectés à deux machines à souder parce que la tension entre les deux pinces peut être le total de la tension à vide des deux machines.
 - f. Si on utilise la machine à souder comme une source de courant pour soudage semi-automatique, ces précautions pour le porte-électrode s'appliquent aussi au pistolet de soudage.
2. Dans le cas de travail au dessus du niveau du sol, se protéger contre les chutes dans le cas où on recoit un choc. Ne jamais enrouler le câble-électrode autour de n'importe quelle partie du corps.
3. Un coup d'arc peut être plus sévère qu'un coup de soleil, donc:
 - a. Utiliser un bon masque avec un verre filtrant approprié ainsi qu'un verre blanc afin de se protéger les yeux du rayonnement de l'arc et des projections quand on soude ou quand on regarde l'arc.
 - b. Porter des vêtements convenables afin de protéger la peau de soudeur et des aides contre le rayonnement de l'arc.
 - c. Protéger l'autre personnel travaillant à proximité au soudage à l'aide d'écrans appropriés et non-inflammables.
4. Des gouttes de laitier en fusion sont émises de l'arc de soudage. Se protéger avec des vêtements de protection libres de l'huile, tels que les gants en cuir, chemise épaisse, pantalons sans revers, et chaussures montantes.
5. Toujours porter des lunettes de sécurité dans la zone de soudage. Utiliser des lunettes avec écrans latéraux dans les

zones où l'on pique le laitier.

6. Eloigner les matériaux inflammables ou les recouvrir afin de prévenir tout risque d'incendie dû aux étincelles.
7. Quand on ne soude pas, poser la pince à un endroit isolé de la masse. Un court-circuit accidentel peut provoquer un échauffement et un risque d'incendie.
8. S'assurer que la masse est connectée le plus près possible de la zone de travail qu'il est pratique de le faire. Si on place la masse sur la charpente de la construction ou d'autres endroits éloignés de la zone de travail, on augmente le risque de voir passer le courant de soudage par les chaînes de levage, câbles de grue, ou autres circuits. Cela peut provoquer des risques d'incendie ou d'échauffement des chaînes et des câbles jusqu'à ce qu'ils se rompent.
9. Assurer une ventilation suffisante dans la zone de soudage. Ceci est particulièrement important pour le soudage de tôles galvanisées plombées, ou cadmiées ou tout autre métal qui produit des fumeés toxiques.
10. Ne pas souder en présence de vapeurs de chlore provenant d'opérations de dégraissage, nettoyage ou pistolage. La chaleur ou les rayons de l'arc peuvent réagir avec les vapeurs du solvant pour produire du phosgène (gas fortement toxique) ou autres produits irritants.
11. Pour obtenir de plus amples renseignements sur la sûreté, voir le code "Code for safety in welding and cutting" CSA Standard W 117.2-1974.

PRÉCAUTIONS DE SÛRETÉ POUR LES MACHINES À SOUDER À TRANSFORMATEUR ET À REDRESSEUR

1. Relier à la terre le châssis du poste conformément au code de l'électricité et aux recommandations du fabricant. Le dispositif de montage ou la pièce à souder doit être branché à une bonne mise à la terre.
2. Autant que possible, l'installation et l'entretien du poste seront effectués par un électricien qualifié.
3. Avant de faire des travaux à l'intérieur de poste, la débrancher à l'interrupteur à la boîte de fusibles.
4. Garder tous les couvercles et dispositifs de sûreté à leur place.

Thank You

for selecting a **QUALITY** product by Lincoln Electric. We want you to take pride in operating this Lincoln Electric Company product
 ••• as much pride as we have in bringing this product to you!

Please Examine Carton and Equipment For Damage Immediately

When this equipment is shipped, title passes to the purchaser upon receipt by the carrier. Consequently, Claims for material damaged in shipment must be made by the purchaser against the transportation company at the time the shipment is received.

Please record your equipment identification information below for future reference. This information can be found on your machine nameplate.

Product _____

Model Number _____

Code Number or Date Code _____

Serial Number _____

Date Purchased _____

Where Purchased _____

Whenever you request replacement parts or information on this equipment, always supply the information you have recorded above. The code number is especially important when identifying the correct replacement parts.

On-Line Product Registration

- Register your machine with Lincoln Electric either via fax or over the Internet.
- For faxing: Complete the form on the back of the warranty statement included in the literature packet accompanying this machine and fax the form per the instructions printed on it.
- For On-Line Registration: Go to our **WEB SITE at www.lincolnelectric.com**. Choose "Quick Links" and then "Product Registration". Please complete the form and submit your registration.

Read this Operators Manual completely before attempting to use this equipment. Save this manual and keep it handy for quick reference. Pay particular attention to the safety instructions we have provided for your protection. The level of seriousness to be applied to each is explained below:

⚠ WARNING

This statement appears where the information **must** be followed **exactly** to avoid **serious personal injury** or **loss of life**.

⚠ CAUTION

This statement appears where the information **must** be followed to avoid **minor personal injury** or **damage to this equipment**.

Installation	Section A
Technical Specifications	A-1
Safety Precautions	A-2
Unpacking	A-2
Filling Coolant Reservoir	A-2
Coolant Connections	A-3
Input Power Connection	A-4
Assembly of Precision Tig	A-4
Fastener Quick Reference	A-5
Connection of Tig Torches	A-5

Operation	Section B
Safety Precautions	B-1
General Description	B-1
Recommended Processes	B-1
Recommended Equipment.....	B-1
Turning the System On	B-2
Cooling Efficiency.....	B-2

Maintenance	Section D
Safety Precautions	D-1
Routine	D-1
Periodic	D-1
Pump.....	D-1
Pump Motor	D-1
Heat Exchanger	D-1
Reservoir Coolant Level.....	D-2
Coolant Treatment Recommendation	D-2, D-3
Pump Inlet Filter	D-3
Procedure	D-3
Additional Service Notes	D-4

Troubleshooting	Section E
Safety Precautions.....	E-1
How to Use Troubleshooting Guide.....	E-1
Troubleshooting Guide	E-2

Diagrams	Section F
Wiring Diagram	F-1
Flow Diagram.....	F-2
Dimension Print.....	F-3

Parts List	P402
-------------------------	-------------

TECHNICAL SPECIFICATIONS – UNDER- WATER COOLER

Model / Make	Under-Cooler Cart K1828-1		
Input	100-120 VAC 50/60 Hz 1 Phase		
Rated Current Draw	60 Hz (2.8-3.5 Amps)	50 Hz (3.5-5.3 Amps)	
Operating Pressure	60 psig (413 kPa) (4.1 bar)		
Pump Hydraulic Rating	No Flow	Discharge Pressure (gage) (Relief Valve Setting)	60 PSIG (414 kPa) (4.14 bar) Max.
	No Pressure	Flow Rate	1.66 gal/min (6.28 liter/min) Max.
Pump Hydraulic Rating (Typical Operation)	Discharge Pressure (gage)		53-57 PSIG (365-393 kPa)
	Flow Rate		.45-.60 gal/min (1.7-2.3 liter/min)
Reservoir Capacity	2.0 Gallons (7.6 Liters)		
Recommended Coolant	<p>For Use Above Freezing: Clean tap, distilled, or de-ionized water</p> <p>For Use Below Freezing: 50% water and 50% pure ethylene glycol mixture.</p> <p>DO NOT USE: Automotive anti-freeze that contains rust inhibitors or leak stoppers. These coolants will damage the pump and block the small internal passageways of the heat exchanger, affecting cooling performance. To acquire the proper coolant contact a local welding distributor.</p> <p>DO NOT USE: Pre-packaged welding industry coolants. These coolants may contain oil-based substances, which attack the plastic components of the cooler. Once added to the cooler, these substances are virtually impossible to purge from the water lines and heat exchanger.</p>		
Weight	Shipping Reservoir Full (Water)	252 lbs. (114 kg)	
		267 lbs. (121 kg)	
Dimensions	Length	41 in (1041 mm)	
	Width	27 in (686 mm)	
	Height (Top Face)	21 in (533mm)	
	Height (TIG Interface)	19 in (483 mm)	

UNDER-COOLER CART



SAFETY PRECAUTIONS:**⚠ WARNING****ELECTRIC SHOCK Can Kill**

- Only qualified persons should perform this installation.

**HOT COOLANT CAN BURN SKIN**

- Always be sure coolant is not hot before doing any work on cooler parts.

**ROTATING FAN BLADES ARE HAZARDOUS**

- Do not put your hands near an operating fan.
- Keep all equipment safety guards, covers and devices in position and in good repair. Keep hands, hair, clothing and tools away from fans and all other moving parts when starting, operating or repairing equipment.
- In some cases it may be necessary to remove safety guards to perform required maintenance. Remove guards only when necessary and replace them when the maintenance requiring their removal is complete. Always use the greatest care when working near moving parts.

UNPACKING

The packaging of the Under-Cooler cart is designed to withstand shipping abuse, and contains a cardboard liner that surrounds the unit. If any shipping damage has occurred, contact your certified Lincoln distributor or service center. When unpacking the unit, avoid thrusting sharp objects through the carton liner, which may damage the heat exchanger or scratch the case. Below is the recommended procedure for unpacking the Cooler:

- Cut banding securing carton and remove carton.
- Remove banding that holds the cart to the skid.
- Remove screws securing rear bottle tray to skid.
- Dislodge front, notched 2 X 4 that secures front casters and remove.
- Roll Under-Cooler Cart forward off of skid
- Cut banding securing drawers and remove and unwrap handle, upper cylinder support assembly, hoses and hardware package located in the storage drawer of the unit.

Save the instruction manual and service directory supplied with the Under-Cooler cart for parts orders and future maintenance service.

FILLING COOLANT RESERVOIR

(See Section A-1 for recommended coolant.)

To avoid freeze damage and water leakage in shipment, the Under-Cooler cart is delivered empty with no coolant in the system. To fill the unit, locate the plastic reservoir fill cap at the front middle of the cooler drawer.

Clean tap water, distilled water, de-ionized water, a 50/50 mix of pure ethylene glycol and water can be added into the coolant reservoir. The reservoir fill hole mates with most coolant containers but, to avoid spillage of coolant, a funnel should be placed into the reservoir hole when filling.

NOTE: Pure solutions and mixtures of, or materials (i.e. towels) wetted with ethylene glycol are toxic to humans and animals. They must not be haphazardly discarded, especially by pouring liquids down the drain. Contact the local EPA office for responsible disposal methods or for recycling information.

For best results when using the Under-Cooler cart with Lincoln torches, use distilled or de-ionized water, although if not available, tap water can be used. If protection from freezing is desired, use a 50% water and 50% pure ethylene glycol mixture and should be ordered from a local welding distributor.

⚠ WARNING

When using the Under-Cooler cart, DO NOT USE OIL BASED COOLANTS OR COOLANTS THAT CONTAIN RUST INHIBITORS OR LEAK STOPPERS.

When adding coolant to the Under-Cooler cart, UNPLUG THE COOLER BEFORE FILLING THE COOLANT RESERVOIR:

ADDING COOLANT:

Carefully add 2 gallons (7.6 liters) of coolant through a funnel into the coolant reservoir fill hole. **AVOID SPILLING COOLANT INTO THE DRAWER OR ONTO THE PUMP MOTOR.**

UNDER-COOLER CART

⚠ CAUTION

NOTE: DO NOT ADD MORE THAN 2 GALLONS (7.6 LITERS) OF COOLANT INTO THE RESERVOIR. The fill cap contains a pressure release air hole, which must not be blocked by overfilling the reservoir with coolant.

Be certain to replace the reservoir fill cap when the reservoir is full. Simply press on the inside center of the fill cap until the cap snaps into place. Operation of the cooler without the fill cap in place can cause poor cooling efficiency, evaporation loss of coolant and reduced product life.

COOLANT CONNECTIONS

The fittings located on the back center of the cooler drawer are two female 5/8-18 left-hand threaded fittings (CGA Style). The hoses provided with this unit are color coded with red (hot) and blue (cold) tape that should be matched up with the decals, also color coded, on both the cooler and the TIG machine. Recommended torque value for the 5/8-18 LH fittings is 12 – 15 ft lbs. If a torque wrench is not available, snug the fittings and check for leaks. Refer to Figure A-1 for decal located adjacent to water connections.

FIGURE A-1



⚠ CAUTION

Be certain that no leaks exist when the cooler is turned on. A leak will deplete reservoir volume, causing poor cooling, performance and reducing torch life.

Note: Be certain that only 5/8-18 left handed male nuts with clean and smooth threads are used on your water hoses. Poor connections cause coolant to leak at the fittings and will deplete the coolant in the reservoir.

If you have hose to make replacement hose assemblies but need to order the fittings and hardware, see below for the correct part numbers to mate with the Under-Cooler cart and the Precision TIG Machine. Then follow the given instructions.

- (2) T15007-2 Connector Nuts
- (2) T15008 Nipples for 3/16" I.D. hose
- (2) S10888-35 Hose Clamps

Remove the connector nut from the INLET hose by making a straight cut 1/4"-1/2" (6-12mm) away from the end of the nipple located inside of the hose. Take the nipple and the connector nut ordered above and insert the nipple into the connector nut so that the threaded end of the connector nut points away from the barbed end of the nipple. Twist the barbed end of the nipple into the hose until the shoulder of the nipple is flush with the end of the hose. Secure the hose onto the nipple with the hose clamp to insure that the connection is watertight. No water can leak from the connection if it is properly attached. Repeat the procedure for the OUTLET hose. When complete, follow the connection procedure detailed above for connecting the hoses to the cooler drawer fittings.

*The connector and nipple listed fit tightly onto 5/32" (4.0mm) to 3/16" (4.8mm) inner diameter hose, but if clamped tightly to the hose, can fit up to a .25 (6.4mm) inner diameter hose.

NOTE: Hoses have been provided with this product and any replacement hoses, purchased or made, should not deviate from their length. To replace these hoses from Lincoln Electric **ORDER (1) S18453-19 (HOT) AND (1) S18453-20 (COLD)**. Hoses too long may be pinched when replacing the gas bottles and hoses too short may be damaged opening the cooler drawer.

UNDER-COOLER CART



INPUT POWER CONNECTION

Plug the input power cord on the Under-Cooler cart into the standard bottom 115V NEMA circuit breaker protected receptacle, located on the back of the Precision TIG machine. Using this receptacle is taking advantage of the "cooler as needed" circuit incorporated into the TIG machine and will prolong the life of the cooler. The lower, or bottom receptacle is clearly marked for this application.

If you wish to use the top 115 V NEMA receptacle located on the back of the machine for cooler operation, the cooler will run 100% of the time that the Precision TIG machine is powered "ON".

ASSEMBLY OF PRECISION TIG

SAFETY PRECAUTIONS

⚠ WARNING

- Protect yourself and others from serious injury
ELECTRIC SHOCK Can Kill



- Disconnect input before servicing.
- Do not touch electrically live parts.
- Do not touch live parts

- Only qualified persons should perform this installation.
- This Undercarriage is designed to handle up to two gas Cylinders.
- After Installation, check all mounting hardware to assure tightness.
- Never use Lift Bale when Undercarriage and Upper Cylinders Supports are attached.
- Keep all Gas Cylinders, placed on Cylinder Platform, tightly chained to Upper Cylinder Support!

CYLINDER may explode if damaged.



- Gas under pressure is explosive. Always keep gas cylinders in an upright position and always keep chained to undercarriage or stationary support.

- Cylinders should be located:

1. Away from areas where they may be struck or subjected to physical damage.
2. A safe distance from arc welding or cutting operations and any other source of heat, sparks or flame

- Never lift a welder with a cylinder attached.
- Never allow welding electrode to touch cylinder.
- Read and follow the instructions on compressed gas cylinders, associated equipment and CGA publication P-1, "Precautions for Safe Handling of Compressed Gases in Cylinders," available from the Compressed Gas Associate., 1235 Jefferson Davis Highway, Arlington VA. 22202

Assembly of the Under-Cooler cart to the Precision TIG machine is actually quite simple. Read carefully the prior warnings and precautions to assembling to a Precision TIG machine.

Assembly:

1. Lift the Precision TIG machine approximately 24" (610mm) off the floor using the lift bale. Lower onto the Under-Cooler cart aligning holes in the TIG base with the two pins on each side of the Under-Cooler cart roof.
2. Fasten the case sides of the Under-Cooler cart to the TIG machine base using items 4 through 7 in the 4 locations shown. Washer, lock washer and nut, (in that order) are to be inside machine base flange with the head of the bolt on the outside of the Under-Cooler cart case side.
3. Remove (4) 5/16-18 X .625 long screws from the front of the machine and discard. Mount handle with the (4) remaining item 4 screws.
4. Lay the upper cylinder support and hook assembly on top of the rear baffle and filler rod holder aligning the top holes. Fasten in (4) places with item 8 screws as shown.
5. Add items 9 through 12 to the lift bale as shown to prevent use of the lift bale with when gas bottles have been loaded. See figure A-2 below.

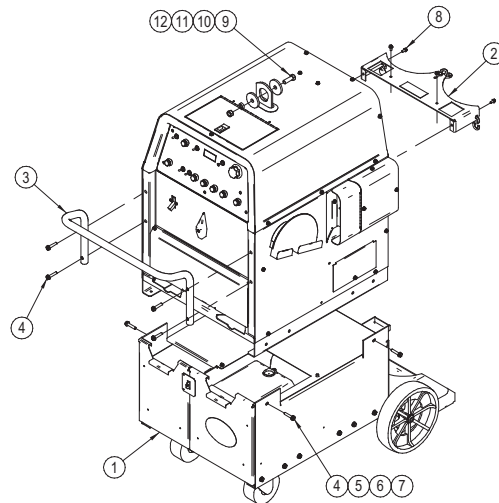

FIGURE A-2

K1828-1 Under-Cooler Cart: Installation Instructions

Items	Part Number	Description	Req'd
1	G3941	Under-Cooler Cart	1
2	M19767	Upper Cylinder Support and Hook Assembly	1
3	L11682	Handle	1
4	S9225-47	5/16-18 x 1.50 Thread Forming Screw	8
5	CF000029	5/16-18 Hex Nut	4
6	E106A-14	5/16 Lock Washer	4
7	S9262-121	5/16 Plain Washer	4
8	S9225-68	1/4-20 x .50 Thread Forming Screw	4
9	CF000030	1/2-13 x 1.25 Hex Head Cap Screw	1
10	S9262-62	1/2 Plain Washer (2.25 O.D.)	2
11	E106A-15	1/2 Lock Washer	1
12	CF000027	1/2-13 Hex Nut	1

UNDER-COOLER CART



INSTALLATION

FASTENER QUICK REFERENCE

(FULL SCALE)

SEE FIGURE A-2 Assembly for fastener placement.

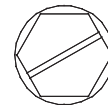
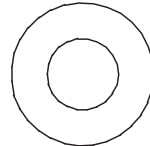
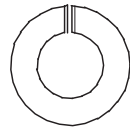
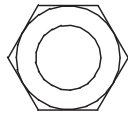
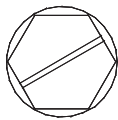
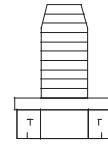
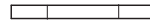
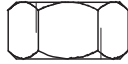
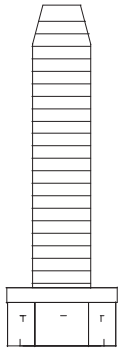

-4-

-5-

-6-

-7-

-8-

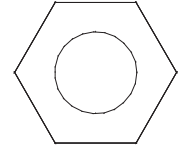
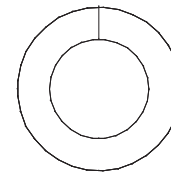
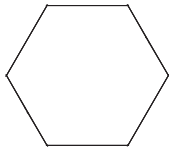
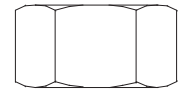
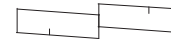
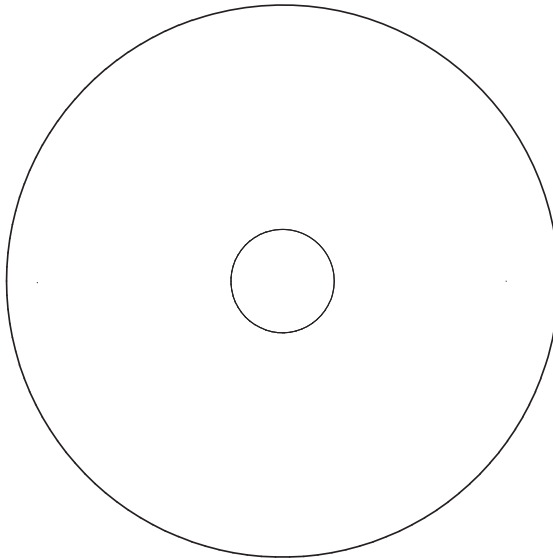
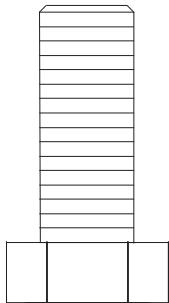

-9-

-11-

-12-

-10-

CONNECTION OF TIG TORCHES

Installation of TIG torches to be used with this Precision TIG Under-Cooler cart is explained in the Precision TIG machine literature. The torch does not directly attach to the cooler but through a connection box mounted on the TIG machine.

SAFETY PRECAUTIONS

WARNING



ELECTRIC SHOCK can kill.

- Disconnect input power by removing plug from receptacle before working inside Cooler.
- Do not operate with covers removed.
- Use only grounded receptacle.
- Do not remove the power cord ground prong.
- Do not touch electrically "hot" parts inside Cooler.
- Have qualified personnel do the installation, maintenance and troubleshooting work.
- Never operate the cooler with the cooler drawer opened except to temporarily check coolant flow in the reservoir.
- Unplug the cooler before performing general maintenance without removing drawer.
- High voltage typical of welding operations can kill.
- Immersion in water around electrical lines can cause electrical shock.
- Moving parts can injure. Never place fingers into openings of Cooler.
- Unplug the cooler and remove water hoses to remove drawer from the cabinet for maintenance purposes. A jumper hose between the coolant in and out connections should be installed to avoid excessive loss of coolant in the system.
- Never operate the cooler with the reservoir fill cap off.
- Hot coolant can burn skin. Always be sure coolant is NOT HOT before servicing the cooler.
- Do not pour used ethylene glycol coolant down the drain.
- Do not remove the pump relief valve's 3/4" hex nut or attempt to adjust the relief valve setting.

 See additional warning information at front of this operator's manual.

GENERAL DESCRIPTION

The Under-Cooler cart is an internal type, re-circulation cooling system designed for use with water-cooled TIG torches. The coolant "IN" and "OUT" connections are 5/8-18 left-hand female threads which match the standard connector nut of domestic water hoses (CGA style) and water-cooled TIG torches. The Under-Cooler cart can either run with the "cooler as needed" circuit, which operates in conjunction with the TIG machine fan, or continuously, powered on and off with the TIG machine power switch.

The overall size and shape of the Under-Cooler cart is designed for mounting the Precision TIG 275 / 375 machine on top. The Under-Cooler cart plugs into a 115 V power receptacle in the rear of the machine and is rated for both 50 or 60 HZ. Adding coolant to the reservoir is simple and connecting to the coolant "IN" and "OUT" connections are easily made with an adjustable wrench.

The Under-Cooler cart coolant flow is circulated through a heat exchanger to remove heat energy from the coolant. The coolant flow is then deposited into the coolant reservoir. The pump draws its coolant supply from the coolant reservoir and delivers coolant to the welding torch. Refer to Flow Diagram Section F.

CAUTION

DO NOT USE A WATER SOLENOID VALVE with the Under-Cooler Cart.

RECOMMENDED PROCESSES

The Under-Cooler Cart is designed for use with the Precision TIG 275 and Precision TIG 375 machines. The recommended 115 V power receptacle is labeled "cooler as needed". This receptacle shuts on and off in conjunction with the TIG machine fan. By using this receptacle, the duty cycle of the cooler is greatly reduced and lets the cooler run only when needed.

RECOMMENDED EQUIPMENT

The Under-Cooler cart is designed for use with the Precision TIG 275 and Precision TIG 375 and any water cooled TIG Torches applicable. Although the cooler could operate as a standalone unit, the cart has been designed specifically to mount these two TIG machines only.

UNDER-COOLER CART



TURNING THE SYSTEM "ON"

CAUTION

After connecting the Precision Tig and Tig Torches per Installation Section, plug the unit into a 115V NEMA electrical receptacle for start-up operation. Be certain that the power input into the unit matches the Cooler's rated input.

The following should always be observed when operating the Under-Cooler Cart:

- Check the coolant reservoir level daily.
- Keep the reservoir full especially after changing any water lines.
- The cooler should turn on as soon as an arc is struck and remain on approximately 8 min. after welding is stopped.
- Be certain that the cooler is ON by checking the flow under the fill cap.
- Never operate the cooler with the reservoir fill cap removed after checking the flow.
- Avoid placing the Under-Cooler Cart and TIG Welder near a flux hopper or an area where dust build-up is extreme.
- Avoid kinking or putting sharp bends in any water lines.
- Keep all water lines clean and free of any blockage.
- Do not operate cooler without coolant in reservoir. Never run pump dry.
- Never lift the Precision TIG by its lift bale once the under-cooler cart has been installed.
- Never lift the Precision TIG and Under-Cooler cart by its handle.

You will be able to hear the fan running and feel air-flow out of the back of the unit when the cooler is operating. The cooler will run continuously unless it is plugged into the switched receptacle on the power source (bottom 115V receptacle).

The coolant FLOW INDICATOR is accessed by removal of the fill cap. Actual return flow is directly visible, via the fill opening of the reservoir with the drawer open. SHUT THE COOLER DRAWER DURING NORMAL OPERATION.

When first starting the unit, check all of the coolant hoses to insure that no water leaks are present. Water leakage causes poor welding performance, poor cooling performance, low welding component life and potential electrical safety hazards.

COOLING EFFICIENCY

The high cooling efficiency of the Under-Cooler cart offers a cooler, more comfortable weld than conventional air-cooled procedures as well as leading competitors water cooled systems.

The Under-Cooler cart effectively removes the heat of the arc away from the torch handle and places it into the exiting air flow at the back of the Cooler. Ambient air temperature affects the coolant temperature of the cooler.

Unlike other water coolers that depend on bulky reservoir size, the high efficiency components of the Under-Cooler cart allows the reservoir size to be small. The result is a lightweight unit, in a drawer with additional storage space for welding accessories.

UNDER-COOLER CART



SAFETY PRECAUTIONS

⚠ WARNING

Have qualified personnel do the maintenance work. In some cases, it may be necessary to remove safety guards to perform required maintenance. Remove guards only when necessary and replace them when the maintenance requiring their removal is complete. Always use the greatest care when working near moving parts.



ELECTRIC SHOCK can kill.

- Do not touch electrically live parts or electrode with skin or wet clothing.
- Insulate yourself from work and ground
- Always wear dry insulating gloves.



MOVING PARTS can injure.

- Do not operate with doors open or guards off.
- Keep away from moving parts.

Observe all Safety Guidelines detailed throughout this manual. Be sure to disconnect the Under-Cooler cart from the Power Source before performing any maintenance procedures.

ROUTINE

Remove accumulated dust and dirt from the internal components of the cooler by blowing it out with a low-pressure air hose or removing it with a vacuum hose.

PERIODIC

In dirty or dusty environments or if biological growth occurs in the coolant, it may be necessary to flush the coolant reservoir. Dump the old coolant, rinse the inside of the reservoir and circulate rinsing solution through coolant system. Add new coolant when cleaning is finished. It is recommended to flush the coolant at least once a year. A cooling system free from debris offers increased cooling efficiency and longer pump and torch life. See the coolant treatment recommendation in "Section D-2".

NOTE: Pure solutions and mixtures of, or materials (i.e. towels) wetted with ethylene glycol are toxic to humans and animals. They must not be haphazardly discarded, especially by pouring liquids down the drain. Contact the local EPA office for responsible disposal methods or for recycling information.

PUMP

The pump head has a "built in" strainer on the inlet side of the pump. **It is recommended to clean or replace the pump's inlet strainer at least annually as follows:**

- Drain the coolant reservoir and all coolant lines. Dispose of the coolant properly as specified above.
- Hold the pump head firmly to apply a counter-torque when loosening the strainers 7/8" acorn nut located on the bottom. Do not confuse with 3/4" acorn nut. Remove nut and slide inlet strainer down and out from the pump head.
- Gently rinse the strainer under running water to thoroughly clean it.
- Use a mirror to inspect the inside of the pump for contamination. Carefully remove hardened debris with a dental pick if necessary, without scratching the inside of the pump.
- Reinstall the strainer and 7/8 acorn nut, tighten to 75 in-lbs.(8.5N-m) of torque. Wipe dry all area wetted with coolant. Dispose of coolant soaked towels properly as specified above.

PUMP MOTOR

The Under-Cooler cart is rated for continuous operation. **It is recommended to re-oil the pump motor bearings once a year as follows:**

- Remove the plastic plugs located on the top of both the inboard and outboard bearing end-caps.
- Re-oil each bearing with 30-35 drops of SAE 20 oil then reinstall both plugs.

HEAT EXCHANGER

To maintain maximum cooler efficiency, the heat exchanger should be kept free of dust and dirt build-up. Clean the heat exchanger periodically using a vacuum hose or a low-pressure air line. Avoid placing the unit near a flux hopper or a flux waste container. A clean heat exchanger offers better cooling performance and longer product life. In extremely dirty environments, it may be necessary to remove the heat exchanger completely from the cooler and clean the fins with soap and water. Use care to avoid damaging the fins.

UNDER-COOLER CART



RESERVOIR COOLANT LEVEL

The reservoir volume should be checked daily before using the cooler. Remove the reservoir fill cap and check the coolant level. The reservoir is full when the coolant level is just below the input elbow of the reservoir (approximate. 2 Gal / 7.6 ltrs). Keep the reservoir full, especially after disconnecting the water lines or changing the accessory being cooled.

COOLANT TREATMENT RECOMMENDATION

This procedure is intended to provide a means of reducing the objectionable amount of fungal and bacterial contamination that has occurred in Under-Cooler cart water coolers and cooling systems.

Limitations:

- This additive should be used with fresh coolants containing only pure water.
- This additive should not be used with coolants containing any other substance, including antifreeze substances.
- No other additives shall be used with the specified coolant that has been treated with the recommended additive.
- This procedure is no permanent substitute for a periodic maintenance schedule for the specified coolers
- A 1 quart bottle of additive is sufficient to disinfect and treat about 720 coolers.
- **Check with the manufacturer of your guns or torches to be sure that this procedure is compatible with your equipment.**
 - a. Additive: "Poly Algaecide 30X" containing 30% of active ingredient Poly oxyethylene (dimethylimino) ethylene (dimethylimino) ethylene dichloride.
 - b. Cooler: Lincoln part number see Parts Pages of this manual.
 - c. Cooling system: the entire system, including cooler and accessories (torch, all connecting hoses, etc.)
 - d. Disinfectant: A user-prepared mixture of fresh, pure water and additive concentrated to 200 ppm maximum.
 - e. ppm: parts per million
 - f. Treated coolant: A user-prepared mixture of fresh, pure water and additive concentrated to a nominal of 30 ppm

Preparation:

- Always switch off the Precision TIG machine power.
- Always disconnect the Under-Cooler cart from the TIG machine receptacle.
- Be sure that the coolant presently in the system is at room temperature to avoid being burned.
- Personal safety equipment: chemical safety glasses, rubber gloves.
- See applicable MSDS for additional information.
- Contact the additive manufacturer, local EPA office or applicable environmental agency for responsible disposal methods of both used, treated coolant and used disinfectant.
- Safety hazards are identified in equipment instruction manuals: refer to specific Power Source machine manual and Under-Cooler cart IM723.

Drain the cooling system of contaminated coolant:

- Do not reuse this coolant.
- If system contained an antifreeze-based coolant, rinse the cooling system until it is clear of antifreeze solution.

Service the cooler:

- Always unplug the cooler and remove hoses connected to the TIG machine. Remove the cooler drawer for thorough cleaning and disinfecting of system.
- Independently flush out the welding accessories of debris if necessary
- Mechanically clean out the cooler, including reservoir, of debris if necessary. Power washing may be useful.
- Clean or replace the pump's inlet strainer as required

UNDER-COOLER CART

Disinfect the cooling system:

- Prepare the disinfectant: Make a quantity of only is needed to avoid an excess.
- Bulk preparation (for coolers serviced in quantity): 2.325 gals. (8.775 liters) of pure, fresh water per cooler 1.625 ml of additive per cooler
- Example: for 100 coolers, add 162.5 ml to 232.5 gals. of pure fresh water Pour 2.0 gals. (7.55 liters) of disinfectant into the empty reservoir
- Recap the reservoir, tape over the air vent in the cap, roll disinfectant around the inside the reservoir to thoroughly coat all of its surfaces.
- Remove the tape from the reservoir cap. Prime the cooling system and circulate disinfectant through it for 10 to 15 minutes.
- Drain disinfectant from the cooling system. Do not reuse this solution.
- Add new, fresh coolant to the cooling system. Add 0.325 gals. (1.225 liters) of fresh disinfectant to the system by pouring it into the reservoir, then reduce the concentration to the nominal 30 ppm:
- Add the balance 1.675 gals. (6.325 liters) of fresh, pure water to the reservoir to create the treated coolant concentration
- Prime the cooling system
- Check coolant level. Add more fresh, pure water if required, without adding more than 0.125 gal. (0.475 liters) of pure water to prevent diluting the coolant additive.

Additive:

The recommended additive can be purchased at local pool supply stores. An example is "Maintain Pool Pro 30% Non-Foam Algaecide".

PUMP INLET FILTER

Poor cooler performance can usually be traced to a partially or completely blocked pump inlet filter. This is a user-serviceable item and can be cleaned and reused, or replaced. Continued pump operation with a blocked filter can cause:

- Voiding of cooler service warranty
- Cavitation damage to the pump heads inlet areas
- Welding accessory damage from overheating due to insufficient coolant flow rate.

A new or properly cleaned pump inlet filter should restore the cooler's performance.

For additional service and periodic maintenance details and for recommended coolants, follow the recommendations listed in the following paragraphs.

PROCEDURE**Preparation:**

- Always switch off the Precision TIG machine power
- Always disconnect the Under-Cooler cart from the Tig machine receptacle.
- Always allow the coolant in the system to cool enough to avoid burn injuries.
- Avoid contact with contaminated coolant. Wear waterproof gloves and protective eyewear.
- Do not remove the pump relief valves 3/4 in. acorn hex nut or attempt to adjust the relief valve setting.

Inspect condition of coolant:

- If coolant is contaminated or old:
 - Drain the system of coolant and dispose of it in an environmentally responsible manner.
 - Flush system of old coolant.
 - Fill with fresh tap or distilled water, run for ten minutes, and drain.
 - Proceed to adding coolant.
- If coolant is clean and fresh:
 - If clean, dedicated coolant handling equipment, including a clean siphon pump and a clean holding tank are available then proceed to servicing the pump inlet strainer.

Removing Coolant:

- Drain coolant from the reservoir using clean siphoning equipment.
- Coolant level should be drained below the filter's pressure fitting:
 - This prevents coolant from streaming out of unit when filter nut is removed.

UNDER-COOLER CART

Service the pump's inlet strainer:

- a. Place absorbent towels underneath pump head to prevent stray coolant from wetting cooler's electrical components.
- b. Hold pump head to apply counter torque when loosening strainers 7/8 acorn nut. Do not confuse with 3/4 acorn nut. Remove nut and slide inlet strainer down and out from pump head. See figure 3A.
- c. Inspect strainer for damage or excessive clogging:
 - **Replace** or **Gently** rinse strainer under running water to thoroughly clean it
- d. Use a mirror to inspect inside of pump for contamination. If hardened debris is present and interferes with filter seating, carefully remove it with dental pick without scratching inside of the pump. Use care not to drop debris into pump.
- e. Reinstall strainer and acorn nut, tighten to 75 in-lbs.(8.5N-m) of torque. Hold pump head to apply counter-torque when loosening strainers 7/8 acorn nut.
- f. Wipe dry all areas wetted by coolant. Dispose of towels in an environmentally responsible manner.

Add coolant:

- Add 2 Gal. (7.6 ltrs.) of coolant, either the recommendations off the water cooled accessory or if none, see the design specification summary listed in this manual.

ADDITIONAL SERVICE NOTES:

- Always use a back-up wrench on pump head when loosening or tightening pump fittings.
- Never run the pump dry. Always use a recommended coolant, otherwise pump damage may result.
- **Flush coolant from system and replace with fresh, recommended coolant at least once a year. More frequent flushing may be necessary, depending upon the user's particular system or its usage, especially if it is prone to clogging from biological growth in the coolant.**

HOW TO USE TROUBLESHOOTING GUIDE

WARNING

Service and Repair should only be performed by Lincoln Electric Factory Trained Personnel. Unauthorized repairs performed on this equipment may result in danger to the technician and machine operator and will invalidate your factory warranty. For your safety and to avoid Electrical Shock, please observe all safety notes and precautions detailed throughout this manual.

This Troubleshooting Guide is provided to help you locate and repair possible machine malfunctions. Simply follow the three-step procedure listed below.

Step 1. LOCATE PROBLEM (SYMPTOM).

Look under the column labeled "PROBLEM (SYMPTOMS)". This column describes possible symptoms that the machine may exhibit. Find the listing that best describes the symptom that the machine is exhibiting.

Step 2. POSSIBLE CAUSE.

The second column labeled "POSSIBLE CAUSE" lists the obvious external possibilities that may contribute to the machine symptom.

Step 3. RECOMMENDED COURSE OF ACTION

This column provides a course of action for the Possible Cause, generally it states to contact your local Lincoln Authorized Field Service Facility.

If you do not understand or are unable to perform the Recommended Course of Action safely, contact your local Lincoln Authorized Field Service Facility.

CAUTION

If for any reason you do not understand the test procedures or are unable to perform the tests/repairs safely, contact your **Local Lincoln Authorized Field Service Facility** for technical troubleshooting assistance before you proceed.

UNDER-COOLER CART



Observe all Safety Guidelines detailed throughout this manual

PROBLEMS (SYMPTOMS)	POSSIBLE AREAS OF MISADJUSTMENTS	RECOMMENDED COURSE OF ACTION
Cooler does not operate	<ol style="list-style-type: none"> 1. Input cord unplugged. 2. Power harness damaged. 3. Water lines blocked or crimped. 4. Leak in gun or water hoses. 5. Coolant reservoir empty. 6. The system needs to be primed. 	<p>If all recommended possible areas of misadjustment have been checked and the problem persists, Contact your local Lincoln Authorized Field Service Facility.</p>
Internal water leak.	<ol style="list-style-type: none"> 1. Hose clamp loose on one of internal hoses. 2. Internal hose punctured. 3. Heat exchanger leaking. 4. Pump seal is leaking. 	
Torch or gun runs hot.	<ol style="list-style-type: none"> 1. Unit placed by area of extreme heat. 2. Low coolant flow. 3. No coolant flow. 4. Fan not operating. 5. Heat exchanger clogged. 6. Pump seal is leaking 	
Fan operates but there is low coolant flow.	<ol style="list-style-type: none"> 1. Leak in torch/gun or hoses. 2. Torch/gun or hoses partially obstructed. 3. Reservoir empty or very low. 4. Pump Strainer is dirty. 	
Fan operates but there is no coolant flow.	<ol style="list-style-type: none"> 1. Pump or pump motor failure. 2. Pump strainer is blocked. 	
Pump operates, but fan does not.	<ol style="list-style-type: none"> 1. Loose or disconnected fan lead. 2. Obstruction in fan blade. 3. Fan motor failure. 	

 **CAUTION**

If for any reason you do not understand the test procedures or are unable to perform the tests/repairs safely, contact your **Local Lincoln Authorized Field Service Facility** for technical troubleshooting assistance before you proceed.

UNDER-COOLER CART



UNDER-COOLER CART

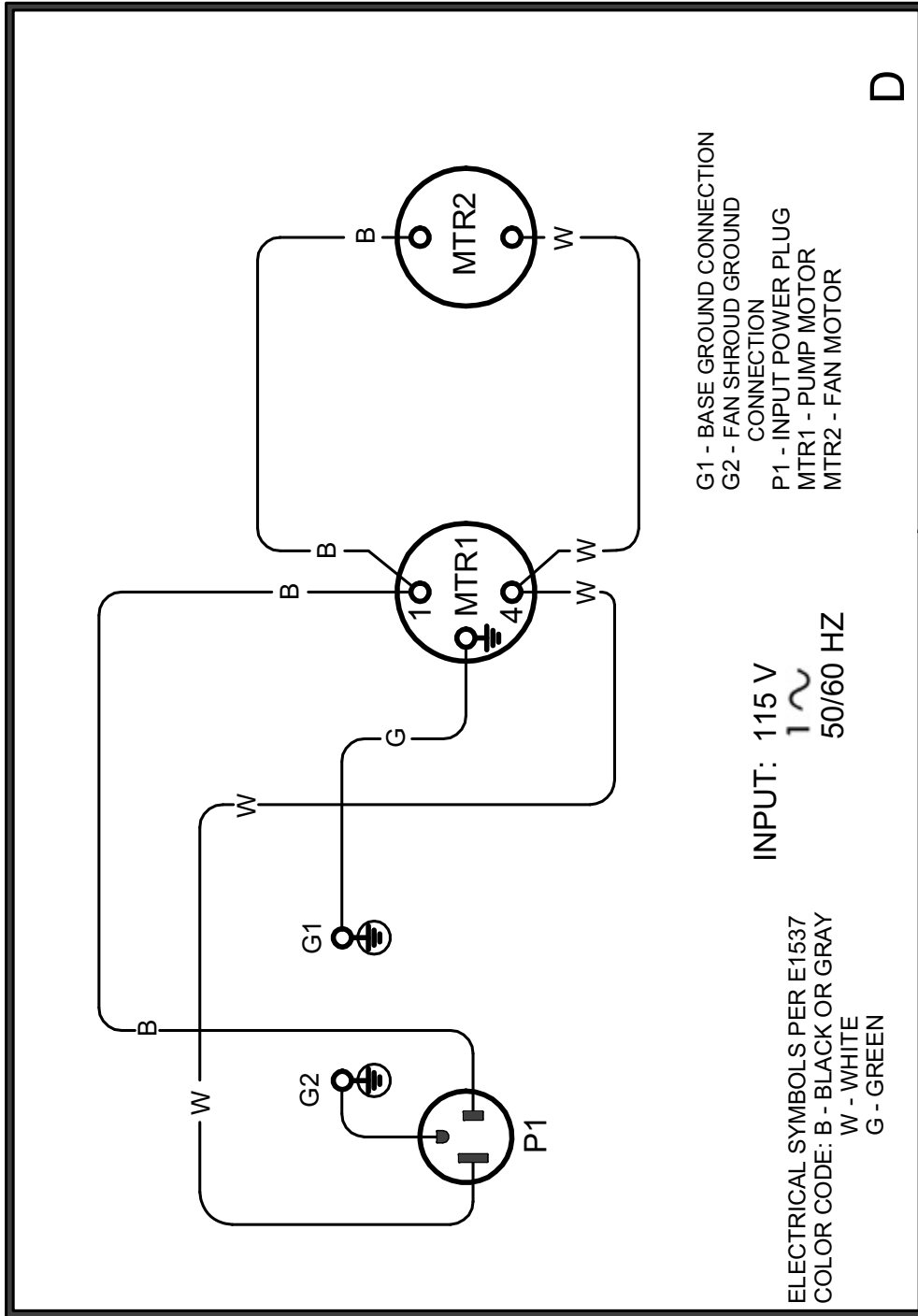

M19812

NOTE: This diagram is for reference only. It may not be accurate for all machines covered by this manual. The specific diagram for a particular code is pasted inside the machine on one of the enclosure panels. If the diagram is illegible, write to the Service Department for a replacement. Give the equipment code number..

UNDER-COOLER CART



K1828-1 Under-Cooler Cart Water Cooler Flow Diagram

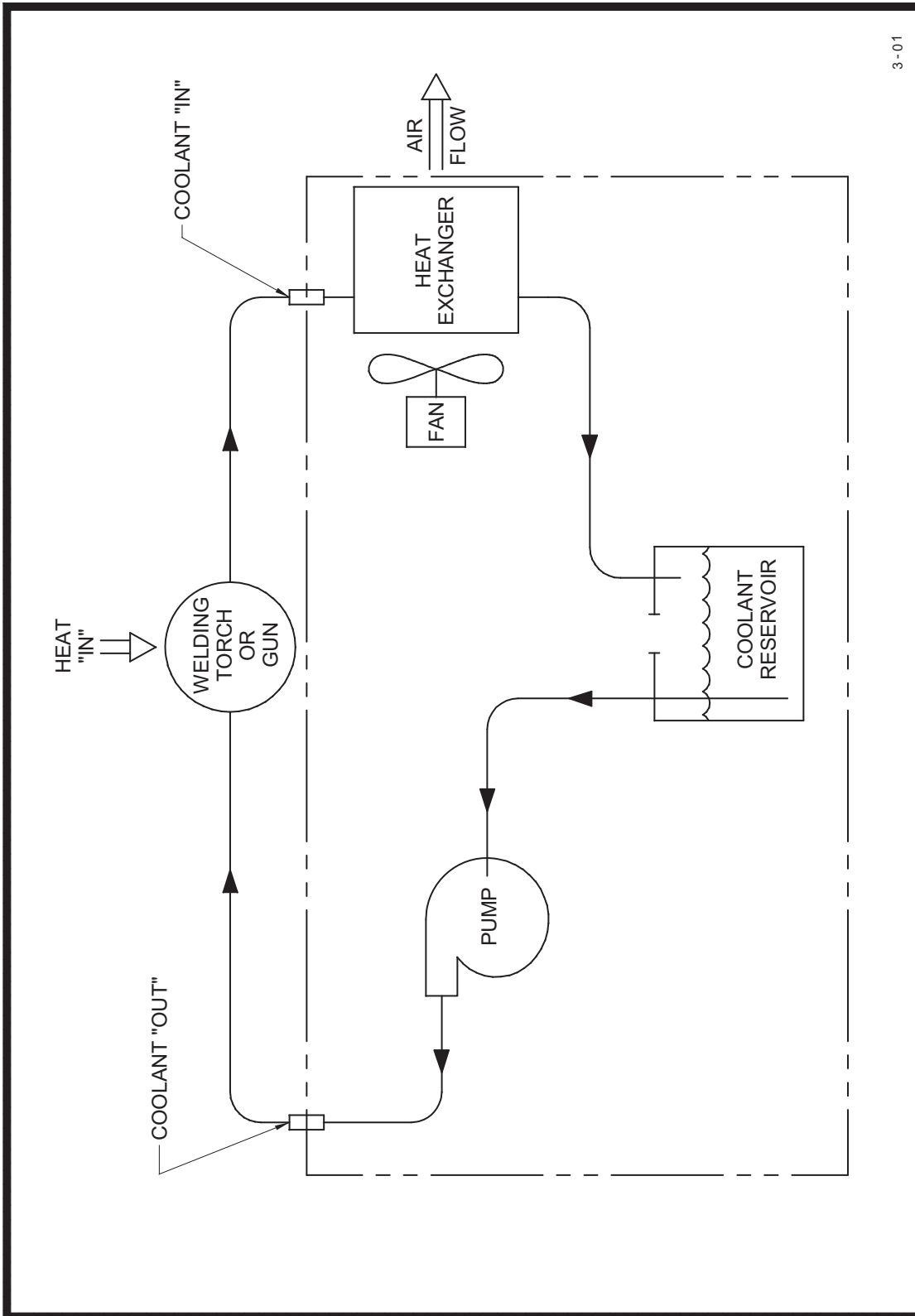

M19724

UNDER-COOLER CART



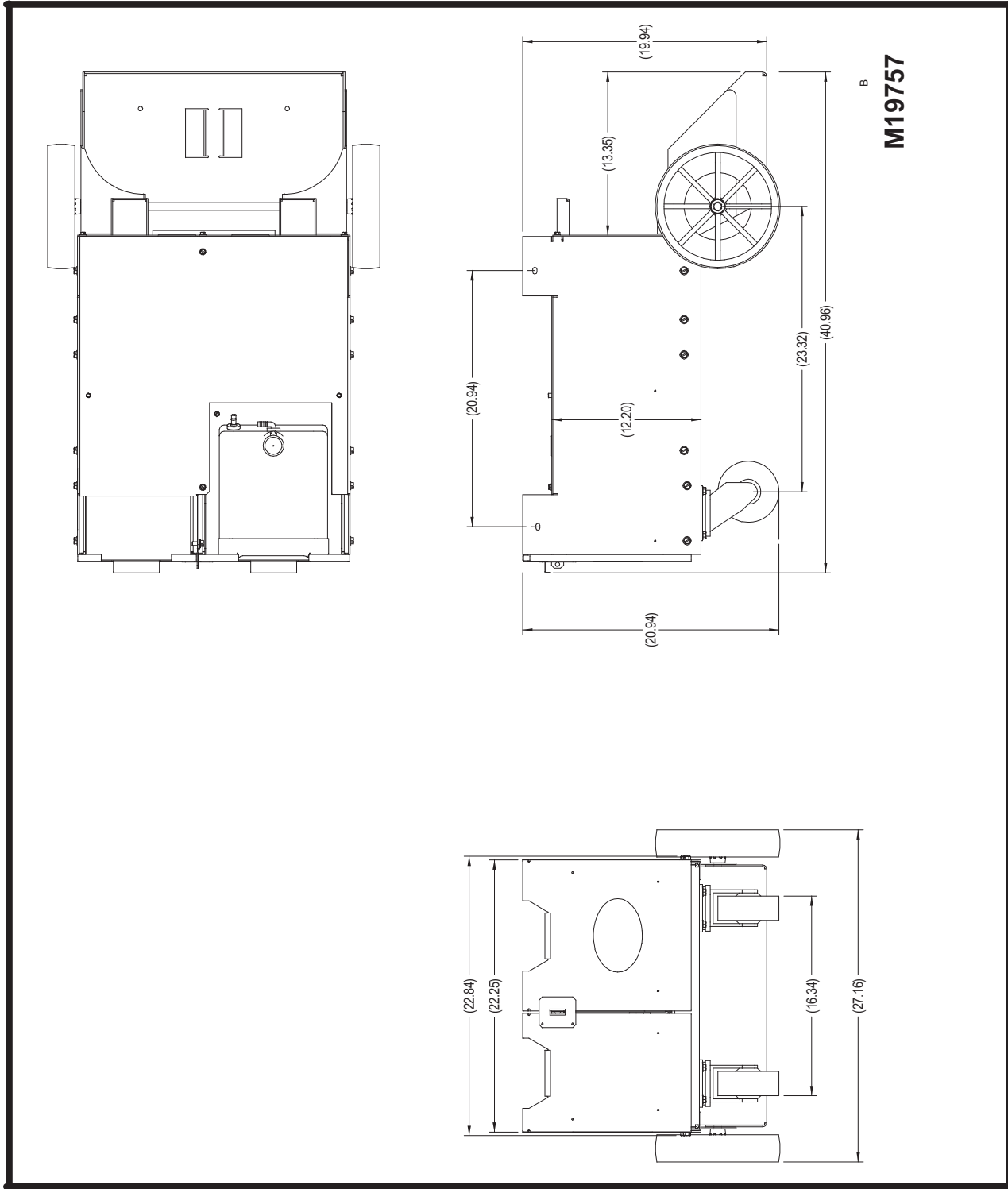

NOTE: This diagram is for reference only. It may not be accurate for all machines covered by this manual. The specific diagram for a particular code is pasted inside the machine on one of the enclosure panels. If the diagram is illegible, write to the Service Department for a replacement. Give the equipment code number..

UNDER-COOLER CART



NOTES

UNDER-COOLER CART



NOTES

UNDER-COOLER CART



NOTES

UNDER-COOLER CART



WARNING	<ul style="list-style-type: none"> ● Do not touch electrically live parts or electrode with skin or wet clothing. ● Insulate yourself from work and ground. 	<ul style="list-style-type: none"> ● Keep flammable materials away. 	<ul style="list-style-type: none"> ● Wear eye, ear and body protection.
Spanish AVISO DE PRECAUCION	<ul style="list-style-type: none"> ● No toque las partes o los electrodos bajo carga con la piel o ropa mojada. ● Aíslese del trabajo y de la tierra. 	<ul style="list-style-type: none"> ● Mantenga el material combustible fuera del área de trabajo. 	<ul style="list-style-type: none"> ● Protéjase los ojos, los oídos y el cuerpo.
French ATTENTION	<ul style="list-style-type: none"> ● Ne laissez ni la peau ni des vêtements mouillés entrer en contact avec des pièces sous tension. ● Isolez-vous du travail et de la terre. 	<ul style="list-style-type: none"> ● Gardez à l'écart de tout matériel inflammable. 	<ul style="list-style-type: none"> ● Protégez vos yeux, vos oreilles et votre corps.
German WARNUNG	<ul style="list-style-type: none"> ● Berühren Sie keine stromführenden Teile oder Elektroden mit Ihrem Körper oder feuchter Kleidung! ● Isolieren Sie sich von den Elektroden und dem Erdboden! 	<ul style="list-style-type: none"> ● Entfernen Sie brennbares Material! 	<ul style="list-style-type: none"> ● Tragen Sie Augen-, Ohren- und Körperschutz!
Portuguese ATENÇÃO	<ul style="list-style-type: none"> ● Não toque partes elétricas e electrodos com a pele ou roupa molhada. ● Isole-se da peça e terra. 	<ul style="list-style-type: none"> ● Mantenha inflamáveis bem guardados. 	<ul style="list-style-type: none"> ● Use proteção para a vista, ouvido e corpo.
Japanese 注意事項	<ul style="list-style-type: none"> ● 通電中の電気部品、又は溶材にヒフやぬれた布で触れないこと。 ● 施工物やアースから身体が絶縁されている様にして下さい。 	<ul style="list-style-type: none"> ● 燃えやすいものの側での溶接作業は絶対にしてはなりません。 	<ul style="list-style-type: none"> ● 目、耳及び身体に保護具をして下さい。
Chinese 警告	<ul style="list-style-type: none"> ● 皮肤或湿衣物切勿接触带电部件及焊条。 ● 使你自已与地面和工件绝缘。 	<ul style="list-style-type: none"> ● 把一切易燃物品移离工作场所。 	<ul style="list-style-type: none"> ● 佩戴眼、耳及身体劳动保护用具。
Korean 위험	<ul style="list-style-type: none"> ● 전도체나 용접봉을 젖은 형갑 또는 피부로 절대 접촉치 마십시오. ● 모재와 접지를 접촉치 마십시오. 	<ul style="list-style-type: none"> ● 인화성 물질을 접근시키지 마십시오. 	<ul style="list-style-type: none"> ● 눈, 귀와 몸에 보호장구를 착용하십시오.
Arabic تحذير	<ul style="list-style-type: none"> ● لا تلمس الاجزاء التي يسري فيها التيار الكهربائي أو الألكترود بجسد الجسم أو بالملابس المبللة بالماء. ● ضع عازلا على جسمك خلال العمل. 	<ul style="list-style-type: none"> ● ضع المواد القابلة للاشتعال في مكان بعيد. 	<ul style="list-style-type: none"> ● ضع أدوات وملابس واقية على عينيك وأذنيك وجسمك.

READ AND UNDERSTAND THE MANUFACTURER'S INSTRUCTION FOR THIS EQUIPMENT AND THE CONSUMABLES TO BE USED AND FOLLOW YOUR EMPLOYER'S SAFETY PRACTICES.

SE RECOMIENDA LEER Y ENTENDER LAS INSTRUCCIONES DEL FABRICANTE PARA EL USO DE ESTE EQUIPO Y LOS CONSUMIBLES QUE VA A UTILIZAR, SIGA LAS MEDIDAS DE SEGURIDAD DE SU SUPERVISOR.

LISEZ ET COMPRENEZ LES INSTRUCTIONS DU FABRICANT EN CE QUI REGARDE CET EQUIPMENT ET LES PRODUITS A ETRE EMPLOYES ET SUIVEZ LES PROCEDURES DE SECURITE DE VOTRE EMPLOYEUR.

LESEN SIE UND BEFOLGEN SIE DIE BETRIEBSANLEITUNG DER ANLAGE UND DEN ELEKTRODENEINSATZ DES HERSTELLERS. DIE UNFALLVERHÜTUNGSVORSCHRIFTEN DES ARBEITGEBERS SIND EBENFALLS ZU BEACHTEN.

<ul style="list-style-type: none"> ● Keep your head out of fumes. ● Use ventilation or exhaust to remove fumes from breathing zone. 	<ul style="list-style-type: none"> ● Turn power off before servicing. 	<ul style="list-style-type: none"> ● Do not operate with panel open or guards off. 	WARNING
<ul style="list-style-type: none"> ● Los humos fuera de la zona de respiración. ● Mantenga la cabeza fuera de los humos. Utilice ventilación o aspiración para gases. 	<ul style="list-style-type: none"> ● Desconectar el cable de alimentación de poder de la máquina antes de iniciar cualquier servicio. 	<ul style="list-style-type: none"> ● No operar con panel abierto o guardas quitadas. 	Spanish AVISO DE PRECAUCION
<ul style="list-style-type: none"> ● Gardez la tête à l'écart des fumées. ● Utilisez un ventilateur ou un aspirateur pour ôter les fumées des zones de travail. 	<ul style="list-style-type: none"> ● Débranchez le courant avant l'entretien. 	<ul style="list-style-type: none"> ● N'opérez pas avec les panneaux ouverts ou avec les dispositifs de protection enlevés. 	French ATTENTION
<ul style="list-style-type: none"> ● Vermeiden Sie das Einatmen von Schweißrauch! ● Sorgen Sie für gute Be- und Entlüftung des Arbeitsplatzes! 	<ul style="list-style-type: none"> ● Strom vor Wartungsarbeiten abschalten! (Netzstrom völlig öffnen; Maschine anhalten!) 	<ul style="list-style-type: none"> ● Anlage nie ohne Schutzgehäuse oder Innenschutzverkleidung in Betrieb setzen! 	German WARNUNG
<ul style="list-style-type: none"> ● Mantenha seu rosto da fumaça. ● Use ventilação e exaustão para remover fumo da zona respiratória. 	<ul style="list-style-type: none"> ● Não opere com as tampas removidas. ● Desligue a corrente antes de fazer serviço. ● Não toque as partes elétricas nuas. 	<ul style="list-style-type: none"> ● Mantenha-se afastado das partes moventes. ● Não opere com os painéis abertos ou guardas removidas. 	Portuguese ATENÇÃO
<ul style="list-style-type: none"> ● ヒュームから頭を離すようにして下さい。 ● 換気や排煙に十分留意して下さい。 	<ul style="list-style-type: none"> ● メンテナンス・サービスに取りかかる際には、まず電源スイッチを必ず切して下さい。 	<ul style="list-style-type: none"> ● パネルやカバーを取り外したまま機械操作をしないで下さい。 	Japanese 注意事項
<ul style="list-style-type: none"> ● 頭部遠離煙霧。 ● 在呼吸區使用通風或排風器除煙。 	<ul style="list-style-type: none"> ● 維修前切斷電源。 	<ul style="list-style-type: none"> ● 儀表板打開或沒有安全罩時不準作業。 	Chinese 警告
<ul style="list-style-type: none"> ● 얼굴로부터 용접가스를 멀리하십시오. ● 호흡지역으로부터 용접가스를 제거하기 위해 가스제거기나 통풍기를 사용하십시오. 	<ul style="list-style-type: none"> ● 보수전에 전원을 차단하십시오. 	<ul style="list-style-type: none"> ● 판넬이 열린 상태로 작동치 마십시오. 	Korean 위험
<ul style="list-style-type: none"> ● ابعد رأسك بعيداً عن الدخان. ● استعمل التهوية أو جهاز ضغط الدخان للخارج لكي تبعد الدخان عن المنطقة التي تتنفس فيها. 	<ul style="list-style-type: none"> ● أقطع التيار الكهربائي قبل القيام بأية صيانة. 	<ul style="list-style-type: none"> ● لا تشغيل هذا الجهاز اذا كانت الاغطية الحديدية الواقية ليست عليه. 	Arabic تحذير

LEIA E COMPREENDA AS INSTRUÇÕES DO FABRICANTE PARA ESTE EQUIPAMENTO E AS PARTES DE USO, E SIGA AS PRÁTICAS DE SEGURANÇA DO EMPREGADOR.

使う機械や溶材のメーカーの指示書をよく読み、まず理解して下さい。そして貴社の安全規定に従って下さい。

請詳細閱讀並理解製造廠提供的說明以及應該使用的銀焊材料，並請遵守貴方的有閣勞動保護規定。

이 제품에 동봉된 작업지침서를 숙지하시고 귀사의 작업자 안전수칙을 준수하시기 바랍니다.

اقرأ بتمعن وافهم تعليمات المصنع المنتج لهذه المعدات والمواد قبل استعمالها واتبع تعليمات الوقاية لصاحب العمل.



• World's Leader in Welding and Cutting Products •

• Sales and Service through Subsidiaries and Distributors Worldwide •

Cleveland, Ohio 44117-1199 U.S.A. TEL: 216.481.8100 FAX: 216.486.1751 WEB SITE: www.lincolnelectric.com

Download from Www.Somanuals.com. All Manuals Search And Download.

Free Manuals Download Website

<http://myh66.com>

<http://usermanuals.us>

<http://www.somanuals.com>

<http://www.4manuals.cc>

<http://www.manual-lib.com>

<http://www.404manual.com>

<http://www.luxmanual.com>

<http://aubethermostatmanual.com>

Golf course search by state

<http://golfingnear.com>

Email search by domain

<http://emailbydomain.com>

Auto manuals search

<http://auto.somanuals.com>

TV manuals search

<http://tv.somanuals.com>