

Ranger[®] 250

For use with machines having Code Numbers: 11401, 11421, 11422

Safety Depends on You

Lincoln arc welding and cutting equipment is designed and built with safety in mind. However, your overall safety can be increased by proper installation ... and thoughtful operation on your part. **DO NOT INSTALL, OPERATE OR REPAIR THIS EQUIPMENT WITHOUT READING THIS MANUAL AND THE SAFETY PRECAUTIONS CONTAINED THROUGHOUT.** And, most importantly, think before you act and be careful.

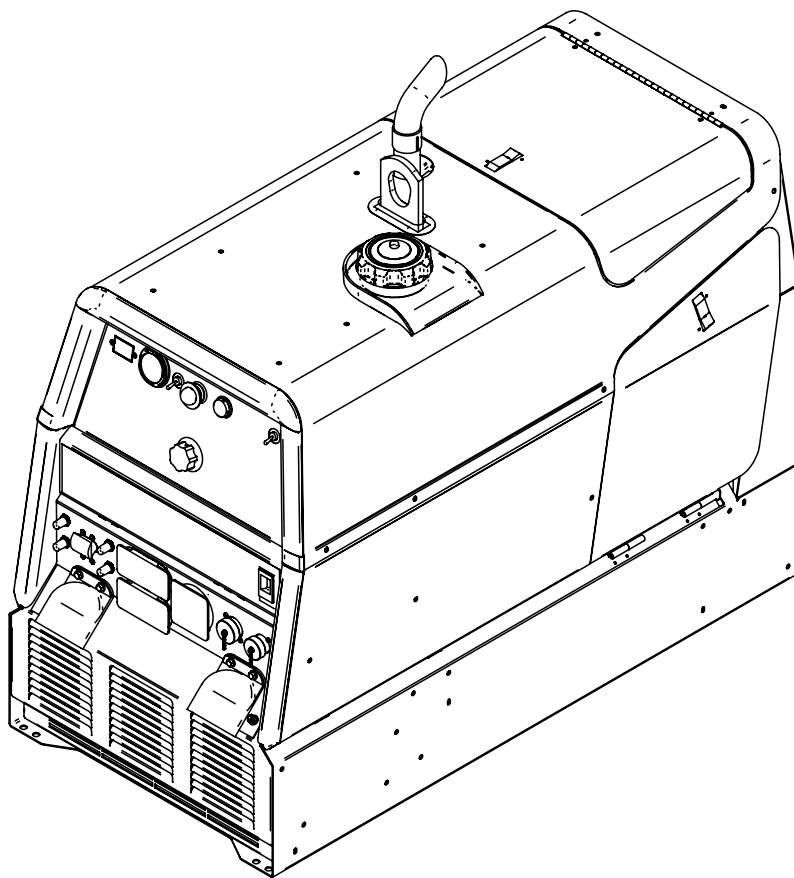

OPERATOR'S MANUAL



LINCOLN[®]
ELECTRIC

Copyright © Lincoln Global Inc.

• World's Leader in Welding and Cutting Products •

• Sales and Service through Subsidiaries and Distributors Worldwide •

Cleveland, Ohio 44117-1199 U.S.A. TEL: 216.481.8100 FAX: 216.486.1751 WEB SITE: www.lincolnelectric.com

Download from Www.Somanuals.com. All Manuals Search And Download.

⚠ WARNING

⚠ CALIFORNIA PROPOSITION 65 WARNINGS ⚠

Diesel engine exhaust and some of its constituents are known to the State of California to cause cancer, birth defects, and other reproductive harm.

The Above For Diesel Engines

The engine exhaust from this product contains chemicals known to the State of California to cause cancer, birth defects, or other reproductive harm.

The Above For Gasoline Engines

ARC WELDING CAN BE HAZARDOUS. PROTECT YOURSELF AND OTHERS FROM POSSIBLE SERIOUS INJURY OR DEATH. KEEP CHILDREN AWAY. PACEMAKER WEARERS SHOULD CONSULT WITH THEIR DOCTOR BEFORE OPERATING.

Read and understand the following safety highlights. For additional safety information, it is strongly recommended that you purchase a copy of "Safety in Welding & Cutting - ANSI Standard Z49.1" from the American Welding Society, P.O. Box 351040, Miami, Florida 33135 or CSA Standard W117.2-1974. A Free copy of "Arc Welding Safety" booklet E205 is available from the Lincoln Electric Company, 22801 St. Clair Avenue, Cleveland, Ohio 44117-1199.

BE SURE THAT ALL INSTALLATION, OPERATION, MAINTENANCE AND REPAIR PROCEDURES ARE PERFORMED ONLY BY QUALIFIED INDIVIDUALS.



FOR ENGINE powered equipment.

1.a. Turn the engine off before troubleshooting and maintenance work unless the maintenance work requires it to be running.



1.b. Operate engines in open, well-ventilated areas or vent the engine exhaust fumes outdoors.



1.c. Do not add the fuel near an open flame welding arc or when the engine is running. Stop the engine and allow it to cool before refueling to prevent spilled fuel from vaporizing on contact with hot engine parts and igniting. Do not spill fuel when filling tank. If fuel is spilled, wipe it up and do not start engine until fumes have been eliminated.

1.d. Keep all equipment safety guards, covers and devices in position and in good repair. Keep hands, hair, clothing and tools away from V-belts, gears, fans and all other moving parts when starting, operating or repairing equipment.

1.e. In some cases it may be necessary to remove safety guards to perform required maintenance. Remove guards only when necessary and replace them when the maintenance requiring their removal is complete. Always use the greatest care when working near moving parts.



1.f. Do not put your hands near the engine fan. Do not attempt to override the governor or idler by pushing on the throttle control rods while the engine is running.

1.g. To prevent accidentally starting gasoline engines while turning the engine or welding generator during maintenance work, disconnect the spark plug wires, distributor cap or magneto wire as appropriate.



1.h. To avoid scalding, do not remove the radiator pressure cap when the engine is hot.



ELECTRIC AND MAGNETIC FIELDS may be dangerous

2.a. Electric current flowing through any conductor causes localized Electric and Magnetic Fields (EMF). Welding current creates EMF fields around welding cables and welding machines

2.b. EMF fields may interfere with some pacemakers, and welders having a pacemaker should consult their physician before welding.

2.c. Exposure to EMF fields in welding may have other health effects which are now not known.

2.d. All welders should use the following procedures in order to minimize exposure to EMF fields from the welding circuit:

2.d.1. Route the electrode and work cables together - Secure them with tape when possible.

2.d.2. Never coil the electrode lead around your body.

2.d.3. Do not place your body between the electrode and work cables. If the electrode cable is on your right side, the work cable should also be on your right side.

2.d.4. Connect the work cable to the workpiece as close as possible to the area being welded.

2.d.5. Do not work next to welding power source.

Mar '95



ELECTRIC SHOCK can kill.

- 3.a. The electrode and work (or ground) circuits are electrically "hot" when the welder is on. Do not touch these "hot" parts with your bare skin or wet clothing. Wear dry, hole-free gloves to insulate hands.
- 3.b. Insulate yourself from work and ground using dry insulation. Make certain the insulation is large enough to cover your full area of physical contact with work and ground.
- In addition to the normal safety precautions, if welding must be performed under electrically hazardous conditions (in damp locations or while wearing wet clothing; on metal structures such as floors, gratings or scaffolds; when in cramped positions such as sitting, kneeling or lying, if there is a high risk of unavoidable or accidental contact with the workpiece or ground) use the following equipment:**
- Semiautomatic DC Constant Voltage (Wire) Welder.
 - DC Manual (Stick) Welder.
 - AC Welder with Reduced Voltage Control.
- 3.c. In semiautomatic or automatic wire welding, the electrode, electrode reel, welding head, nozzle or semiautomatic welding gun are also electrically "hot".
- 3.d. Always be sure the work cable makes a good electrical connection with the metal being welded. The connection should be as close as possible to the area being welded.
- 3.e. Ground the work or metal to be welded to a good electrical (earth) ground.
- 3.f. Maintain the electrode holder, work clamp, welding cable and welding machine in good, safe operating condition. Replace damaged insulation.
- 3.g. Never dip the electrode in water for cooling.
- 3.h. Never simultaneously touch electrically "hot" parts of electrode holders connected to two welders because voltage between the two can be the total of the open circuit voltage of both welders.
- 3.i. When working above floor level, use a safety belt to protect yourself from a fall should you get a shock.
- 3.j. Also see Items 6.c. and 8.



ARC RAYS can burn.

- 4.a. Use a shield with the proper filter and cover plates to protect your eyes from sparks and the rays of the arc when welding or observing open arc welding. Headshield and filter lens should conform to ANSI Z87.1 standards.
- 4.b. Use suitable clothing made from durable flame-resistant material to protect your skin and that of your helpers from the arc rays.
- 4.c. Protect other nearby personnel with suitable, non-flammable screening and/or warn them not to watch the arc nor expose themselves to the arc rays or to hot spatter or metal.



FUMES AND GASES can be dangerous.

- 5.a. Welding may produce fumes and gases hazardous to health. Avoid breathing these fumes and gases. When welding, keep your head out of the fume. Use enough ventilation and/or exhaust at the arc to keep fumes and gases away from the breathing zone. **When welding with electrodes which require special ventilation such as stainless or hard facing (see instructions on container or MSDS) or on lead or cadmium plated steel and other metals or coatings which produce highly toxic fumes, keep exposure as low as possible and below Threshold Limit Values (TLV) using local exhaust or mechanical ventilation. In confined spaces or in some circumstances, outdoors, a respirator may be required. Additional precautions are also required when welding on galvanized steel.**
5. b. The operation of welding fume control equipment is affected by various factors including proper use and positioning of the equipment, maintenance of the equipment and the specific welding procedure and application involved. Worker exposure level should be checked upon installation and periodically thereafter to be certain it is within applicable OSHA PEL and ACGIH TLV limits.
- 5.c. Do not weld in locations near chlorinated hydrocarbon vapors coming from degreasing, cleaning or spraying operations. The heat and rays of the arc can react with solvent vapors to form phosgene, a highly toxic gas, and other irritating products.
- 5.d. Shielding gases used for arc welding can displace air and cause injury or death. Always use enough ventilation, especially in confined areas, to insure breathing air is safe.
- 5.e. Read and understand the manufacturer's instructions for this equipment and the consumables to be used, including the material safety data sheet (MSDS) and follow your employer's safety practices. MSDS forms are available from your welding distributor or from the manufacturer.
- 5.f. Also see item 1.b.

AUG 06

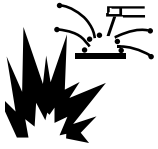

WELDING and CUTTING SPARKS can cause fire or explosion.

6.a. Remove fire hazards from the welding area. If this is not possible, cover them to prevent the welding sparks from starting a fire.

Remember that welding sparks and hot materials from welding can easily go through small cracks and openings to adjacent areas. Avoid welding near hydraulic lines. Have a fire extinguisher readily available.

- 6.b. Where compressed gases are to be used at the job site, special precautions should be used to prevent hazardous situations. Refer to "Safety in Welding and Cutting" (ANSI Standard Z49.1) and the operating information for the equipment being used.
- 6.c. When not welding, make certain no part of the electrode circuit is touching the work or ground. Accidental contact can cause overheating and create a fire hazard.
- 6.d. Do not heat, cut or weld tanks, drums or containers until the proper steps have been taken to insure that such procedures will not cause flammable or toxic vapors from substances inside. They can cause an explosion even though they have been "cleaned". For information, purchase "Recommended Safe Practices for the Preparation for Welding and Cutting of Containers and Piping That Have Held Hazardous Substances", AWS F4.1 from the American Welding Society (see address above).
- 6.e. Vent hollow castings or containers before heating, cutting or welding. They may explode.
- 6.f. Sparks and spatter are thrown from the welding arc. Wear oil free protective garments such as leather gloves, heavy shirt, cuffless trousers, high shoes and a cap over your hair. Wear ear plugs when welding out of position or in confined places. Always wear safety glasses with side shields when in a welding area.
- 6.g. Connect the work cable to the work as close to the welding area as practical. Work cables connected to the building framework or other locations away from the welding area increase the possibility of the welding current passing through lifting chains, crane cables or other alternate circuits. This can create fire hazards or overheat lifting chains or cables until they fail.
- 6.h. Also see item 1.c.
- 6.i. Read and follow NFPA 51B "Standard for Fire Prevention During Welding, Cutting and Other Hot Work", available from NFPA, 1 Batterymarch Park, PO box 9101, Quincy, Ma 022690-9101.
- 6.j. Do not use a welding power source for pipe thawing.

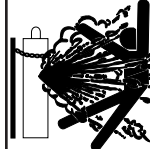

CYLINDER may explode if damaged.

7.a. Use only compressed gas cylinders containing the correct shielding gas for the process used and properly operating regulators designed for the gas and pressure used. All hoses, fittings, etc. should be suitable for the application and maintained in good condition.

- 7.b. Always keep cylinders in an upright position securely chained to an undercarriage or fixed support.
- 7.c. Cylinders should be located:
- Away from areas where they may be struck or subjected to physical damage.
 - A safe distance from arc welding or cutting operations and any other source of heat, sparks, or flame.
- 7.d. Never allow the electrode, electrode holder or any other electrically "hot" parts to touch a cylinder.
- 7.e. Keep your head and face away from the cylinder valve outlet when opening the cylinder valve.
- 7.f. Valve protection caps should always be in place and hand tight except when the cylinder is in use or connected for use.
- 7.g. Read and follow the instructions on compressed gas cylinders, associated equipment, and CGA publication P-1, "Precautions for Safe Handling of Compressed Gases in Cylinders," available from the Compressed Gas Association 1235 Jefferson Davis Highway, Arlington, VA 22202.



FOR ELECTRICALLY powered equipment.

- 8.a. Turn off input power using the disconnect switch at the fuse box before working on the equipment.
- 8.b. Install equipment in accordance with the U.S. National Electrical Code, all local codes and the manufacturer's recommendations.
- 8.c. Ground the equipment in accordance with the U.S. National Electrical Code and the manufacturer's recommendations.

Jan, 07

PRÉCAUTIONS DE SÛRETÉ

Pour votre propre protection lire et observer toutes les instructions et les précautions de sûreté spécifiques qui paraissent dans ce manuel aussi bien que les précautions de sûreté générales suivantes:

Sûreté Pour Soudage A L'Arc

1. Protégez-vous contre la secousse électrique:
 - a. Les circuits à l'électrode et à la pièce sont sous tension quand la machine à souder est en marche. Eviter toujours tout contact entre les parties sous tension et la peau nue ou les vêtements mouillés. Porter des gants secs et sans trous pour isoler les mains.
 - b. Faire très attention de bien s'isoler de la masse quand on soude dans des endroits humides, ou sur un plancher métallique ou des grilles métalliques, principalement dans les positions assis ou couché pour lesquelles une grande partie du corps peut être en contact avec la masse.
 - c. Maintenir le porte-électrode, la pince de masse, le câble de soudage et la machine à souder en bon et sûr état de fonctionnement.
 - d. Ne jamais plonger le porte-électrode dans l'eau pour le refroidir.
 - e. Ne jamais toucher simultanément les parties sous tension des porte-électrodes connectés à deux machines à souder parce que la tension entre les deux pinces peut être le total de la tension à vide des deux machines.
 - f. Si on utilise la machine à souder comme une source de courant pour soudage semi-automatique, ces précautions pour le porte-électrode s'appliquent aussi au pistolet de soudage.
2. Dans le cas de travail au dessus du niveau du sol, se protéger contre les chutes dans le cas où on reçoit un choc. Ne jamais enrouler le câble-électrode autour de n'importe quelle partie du corps.
3. Un coup d'arc peut être plus sévère qu'un coup de soleil, donc:
 - a. Utiliser un bon masque avec un verre filtrant approprié ainsi qu'un verre blanc afin de se protéger les yeux du rayonnement de l'arc et des projections quand on soude ou quand on regarde l'arc.
 - b. Porter des vêtements convenables afin de protéger la peau de soudeur et des aides contre le rayonnement de l'arc.
 - c. Protéger l'autre personnel travaillant à proximité au soudage à l'aide d'écrans appropriés et non-inflammables.
4. Des gouttes de laitier en fusion sont émises de l'arc de soudage. Se protéger avec des vêtements de protection libres de l'huile, tels que les gants en cuir, chemise épaisse, pantalons sans revers, et chaussures montantes.
5. Toujours porter des lunettes de sécurité dans la zone de soudage. Utiliser des lunettes avec écrans latéraux dans les zones où l'on pique le laitier.

6. Eloigner les matériaux inflammables ou les recouvrir afin de prévenir tout risque d'incendie dû aux étincelles.
7. Quand on ne soude pas, poser la pince à un endroit isolé de la masse. Un court-circuit accidentel peut provoquer un échauffement et un risque d'incendie.
8. S'assurer que la masse est connectée le plus près possible de la zone de travail qu'il est pratique de le faire. Si on place la masse sur la charpente de la construction ou d'autres endroits éloignés de la zone de travail, on augmente le risque de voir passer le courant de soudage par les chaînes de levage, câbles de grue, ou autres circuits. Cela peut provoquer des risques d'incendie ou d'échauffement des chaînes et des câbles jusqu'à ce qu'ils se rompent.
9. Assurer une ventilation suffisante dans la zone de soudage. Ceci est particulièrement important pour le soudage de tôles galvanisées plombées, ou cadmiées ou tout autre métal qui produit des fumées toxiques.
10. Ne pas souder en présence de vapeurs de chlore provenant d'opérations de dégraissage, nettoyage ou pistilage. La chaleur ou les rayons de l'arc peuvent réagir avec les vapeurs du solvant pour produire du phosgène (gas fortement toxique) ou autres produits irritants.
11. Pour obtenir de plus amples renseignements sur la sûreté, voir le code "Code for safety in welding and cutting" CSA Standard W 117.2-1974.

PRÉCAUTIONS DE SÛRETÉ POUR LES MACHINES À SOUDER À TRANSFORMATEUR ET À REDRESSEUR

1. Relier à la terre le châssis du poste conformément au code de l'électricité et aux recommandations du fabricant. Le dispositif de montage ou la pièce à souder doit être branché à une bonne mise à la terre.
2. Autant que possible, l'installation et l'entretien du poste seront effectués par un électricien qualifié.
3. Avant de faire des travaux à l'intérieur de poste, le débrancher à l'interrupteur à la boîte de fusibles.
4. Garder tous les couvercles et dispositifs de sûreté à leur place.

Mar. '93

Thank You

for selecting a **QUALITY** product by Lincoln Electric. We want you to take pride in operating this Lincoln Electric Company product
... as much pride as we have in bringing this product to you!

CUSTOMER ASSISTANCE POLICY

The business of The Lincoln Electric Company is manufacturing and selling high quality welding equipment, consumables, and cutting equipment. Our challenge is to meet the needs of our customers and to exceed their expectations. On occasion, purchasers may ask Lincoln Electric for advice or information about their use of our products. We respond to our customers based on the best information in our possession at that time. Lincoln Electric is not in a position to warrant or guarantee such advice, and assumes no liability, with respect to such information or advice. We expressly disclaim any warranty of any kind, including any warranty of fitness for any customer's particular purpose, with respect to such information or advice. As a matter of practical consideration, we also cannot assume any responsibility for updating or correcting any such information or advice once it has been given, nor does the provision of information or advice create, expand or alter any warranty with respect to the sale of our products.

Lincoln Electric is a responsive manufacturer, but the selection and use of specific products sold by Lincoln Electric is solely within the control of, and remains the sole responsibility of the customer. Many variables beyond the control of Lincoln Electric affect the results obtained in applying these types of fabrication methods and service requirements.

Subject to Change – This information is accurate to the best of our knowledge at the time of printing. Please refer to www.lincolnelectric.com for any updated information.

Please Examine Carton and Equipment For Damage Immediately

When this equipment is shipped, title passes to the purchaser upon receipt by the carrier. Consequently, Claims for material damaged in shipment must be made by the purchaser against the transportation company at the time the shipment is received.

Please record your equipment identification information below for future reference. This information can be found on your machine nameplate.

Product _____

Model Number _____

Code Number or Date Code _____

Serial Number _____

Date Purchased _____

Where Purchased _____

Whenever you request replacement parts or information on this equipment, always supply the information you have recorded above. The code number is especially important when identifying the correct replacement parts.

On-Line Product Registration

- Register your machine with Lincoln Electric either via fax or over the Internet.
- For faxing: Complete the form on the back of the warranty statement included in the literature packet accompanying this machine and fax the form per the instructions printed on it.
- For On-Line Registration: Go to our **WEB SITE at www.lincolnelectric.com**. Choose "Quick Links" and then "Product Registration". Please complete the form and submit your registration.

Read this Operators Manual completely before attempting to use this equipment. Save this manual and keep it handy for quick reference. Pay particular attention to the safety instructions we have provided for your protection. The level of seriousness to be applied to each is explained below:

⚠ WARNING

This statement appears where the information **must** be followed **exactly** to avoid **serious personal injury or loss of life**.

⚠ CAUTION

This statement appears where the information **must** be followed to avoid **minor personal injury or damage to this equipment**.

Installation.....	Section A
Technical Specifications	A-1
Machine Specifications	A-2
Safety Precautions	A-3
Location and Ventilation	A-3
Stacking	A-3
Angle of Operation	A-3
Lifting	A-3
Additional Safety Precautions	A-3
High Altitude Operation	A-3
High Temperature Operation	A-3
Towing.....	A-4
Vehicle Mounting.....	A-4
Pre-Operation Engine Service.....	A-4
Oil	A-4
Fuel	A-4
Engine Coolant.....	A-4
Battery Connections.....	A-4
Muffler Outlet Pipe	A-5
Spark Arrester	A-5
High Frequency Generators for Tig Applications	A-5
Remote Control	A-5
Electrical Connections	A-5
Machine Grounding.....	A-5
Welding Terminals	A-6
Welding Output Cables	A-6
Cable Installation.....	A-6
Auxiliary Power Receptacles and Plugs.....	A-6
Standby Power Connections	A-6
Premises Wiring	A-7
Connection of Lincoln Electric Wire Feeders.....	A-8, A-9
<hr/>	
Operation.....	Section B
Safety Precautions	B-1
General Description.....	B-1
Design Features	B-1
Engine Operation	B-1
Fuel	B-1
Welding Controls	B-2
Engine Controls.....	B-3
Starting and Stopping the Engine	B-3
Stopping	B-4
Welding Operation.....	B-4
Duty Cycle	B-4
DC Stick Welding	B-4
Constant Current (Stick) Welding.....	B-4
Downhill Pipe Welding	B-4
Fuel Consumption	B-4
Tig Welding	B-5
Typical Current Ranges for Tungsten Electrodes	B-5
Wire Welding-CV.....	B-5
Arc Gouging	B-6
Auxiliary Power	B-6
Simultaneous Welding and Auxiliary Power Loads.....	B-6
Extension Cord Recommendations.....	B-6
<hr/>	
Accessories	Section C
Recommended Optional Equipment.....	C-1

Maintenance	Section D
Safety Precautions	D-1
Routine Maintenance	D-1
Kohler / Robin-Subaru Engine Maintenance Components.....	D-1
Kohler Engine	D-1
Subaru Robin Engine	D-1
Engine Oil Change.....	D-2
Engine Oil Refill Capacities (Kohler / Subaru Robin).....	D-2
Oil Filter Change	D-2
Air Cleaner Service	D-2
Air Pre-Cleaner Service	D-2
Air Filter Paper Element.....	D-3
Spark Plug	D-3
Spark Plug Service	D-3
Fuel Filter.....	D-4
Engine Adjustment.....	D-4
Battery Maintenance	D-4
Option Spark Arrestor.....	D-4
Welder / Generator Maintenance	D-5
Storage	D-5
Cleaning.....	D-5
Brush Removal and Replacement	D-5

Troubleshooting	Section E
How to Use Troubleshooting Guide.....	E-1
Troubleshooting Guide	E-2
Troubleshooting Guide	E-3
Troubleshooting Guide	E-4
Troubleshooting Guide	E-5

Diagrams & Dimension Print	Section F
---	------------------

Parts List	P-490 Series
-------------------------	---------------------

TECHNICAL SPECIFICATIONS - Ranger® 250 (K1725-10, K1725-11, K1725-12)

INPUT - GASOLINE ENGINE						
Make/Model	Description	Horsepower @ 3600 RPM	Operating SPEED	Displacement cu. in.(cu. cm) Bore x Stroke in.(mm)	Starting System	Capacities
K1725-10, -11 Kohler CH23S OHV	2 Cylinder 4 Cycle Air Cooled Gasoline Engine	23 HP	High 3700RPM	41.1 (674) 3.15x 2.64 (80x67)	12VDC Battery and starter Push Button Starter	Fuel: 12gal.(45.4L) Oil: 2.0qts.(1.9L)
K1725-12 Subaru Robin EH65 OHV		22 HP	Low Idle 2400RPM	39.8 (653) 3.15x 2.56 (80x65)	Group 58 Battery (435 cold crank amps)	Fuel: 12gal.(45.4L) Oil: 1.6qts.(1.5L)
RATED OUTPUT @ 104°F(40C°) - WELDER						
Welding Output		Volts at Rated Amps		Duty Cycle Max.	OCV @ 3700 RPM	
CC STICK & PIPE DC Output		28 Volts at 250 Amps		100%	60 Volts	
STICK / PIPE Output Range		40 to 250 Amps				
TIG Output Range		20 to 250 Amps				
CV WIRE DC Output		28 Volts at 250 Amps		100%		
CV WIRE DC Output		27 Volts at 275 Amps		60%		
CV WIRE Output Range		14 to 28 volts				
RATED OUTPUT @ 104°F(40C°) - GENERATOR						
Auxiliary Power ¹						
10,500 Watts Peak, 9500 Watts Continuous, 60 Hz 120/240 Volts						
PHYSICAL DIMENSIONS						
HEIGHT	WIDTH		DEPTH	WEIGHT		
30.00** in. 762.0 mm	21.50 in. 546.0 mm		42.25 in. 1073.0 mm	500 lbs. (227kg.)		
**Top of enclosure, add 6.4" (164mm) for exhaust.						
ENGINE COMPONENTS						
LUBRICATION	VALVE LIFTERS	FUEL SYSTEM		GOVERNOR		
Full Pressure with Full Flow Filter	Hydraulic (Kohler)	Mechanical Fuel Pump (Kohler) Additional electric fuel lift pump on K1725-11 Kohler Model		Mechanical Governor 5% Regulation (Kohler)		
	Solid (Subaru Robin)	Diaphragm pressure pulse pump (Subaru Robin)		Centrifugal Flywheel (Subaru Robin)		
AIR CLEANER	ENGINE IDLER	MUFFLER		ENGINE PROTECTION		
Dual Element	Automatic Idler	Low noise Muffler: Top outlet can be rotated. Made from long life, aluminized steel.		Shutdown on low oil pressure.		

1. Output rating in watts is equivalent to volt-amperes at unity power factor. Output voltage is within ± 10% at all loads up to rated capacity. When welding, available auxiliary power will be reduced.

RANGER® 250



MACHINE SPECIFICATIONS - Ranger® 250 (K1725-10, K1725-11, K1725-12)

RECEPTACLES AND CIRCUIT BREAKERS		
RECEPTACLES	AUXILIARY POWER CIRCUIT BREAKER	OTHER CIRCUIT BREAKERS
(2) 120VAC Duplex (5-20R) (1) 120/240VAC Dual Voltage Full KVA (14-50R)	Two 20AMP for Two Duplex Receptacle One 50AMP for Dual Voltage (2-Pole)	20AMP for Battery Charging Circuit 15AMP for 42V Wire Feeder Power

SAFETY PRECAUTIONS

⚠ WARNING

Do not attempt to use this equipment until you have thoroughly read the engine manufacturer's manual supplied with your welder. It includes important safety precautions, detailed engine starting, operating and maintenance instructions, and parts lists.



ELECTRIC SHOCK can kill.

- Do not touch electrically live parts or electrode with skin or wet clothing.
- Insulate yourself from work and ground
- Always wear dry insulating gloves.



ENGINE EXHAUST can kill.

- Use in open, well ventilated areas or vent exhaust outside.



MOVING PARTS can injure.

- Do not operate with doors open or guards off.
- Stop engine before servicing.
- Keep away from moving parts.

- See additional warning information at front of this operator's manual.

- Only qualified personnel should install, use, or service this equipment.

LOCATION AND VENTILATION

The welder should be located to provide an unrestricted flow of clean, cool air to the cooling air inlets and to avoid restricting the cooling air outlets. Also, locate the welder so that the engine exhaust fumes are properly vented to an outside area.

STACKING

Ranger® 250 machines cannot be stacked.

ANGLE OF OPERATION

Engines are designed to run in the level condition which is where the optimum performance is achieved. The maximum angle of continuous operation is 15 degrees in any direction. If the engine is to be operated at an angle, provisions must be made for checking and maintaining the oil level at the normal (FULL) oil capacity in the crankcase.

When operating the welder at an angle, the effective fuel capacity will be slightly less than the specified 12 gallons.

LIFTING

The RANGER® 250 weighs approximately 575 lbs. with a full tank of gasoline. A lift bail is mounted to the machine and should always be used when lifting the machine.

ADDITIONAL SAFETY PRECAUTIONS

⚠ WARNING



FALLING EQUIPMENT can cause injury.

- Lift only with equipment of adequate lifting capacity.
- Be sure machine is stable when lifting.
- Do not lift this machine using lift bale if it is equipped with a heavy accessory such as trailer or gas cylinder.
- Do not lift machine if lift bale is damaged.
- Do not operate machine while suspended from lift bale.

HIGH ALTITUDE OPERATION

At higher altitudes, Welder output de-rating may be necessary. For maximum rating, de-rate the welder output 3.5% for every 1000 ft. (305m) above 3000 ft. (914m). If operation will consistently be at altitudes above 5,000 ft. (1525m), a carburetor jet designed for high altitudes should be installed. This will result in better fuel economy, cleaner exhaust and longer spark plug life. It will not give increased power. Contact your local authorized engine service shop for high altitude jet kits that are available from the engine manufacturer.

⚠ CAUTION

Do not operate with a high altitude jet installed at altitudes below 5000 ft. This will result in the engine running too lean and result in higher engine operating temperatures which can shorten engine life.

HIGH TEMPERATURE OPERATION

At temperatures above 104°F(40°C),Welder output de-rating is necessary. For maximum output ratings, de-rate the welder output 2 Volts for every 50°F(10°C) above 104°F(40°C).

RANGER® 250



TOWING

The recommended trailer for use with this equipment for road, in-plant and yard towing by a vehicle⁽¹⁾ is Lincoln's K957-1. If the user adapts a non-Lincoln trailer, he must assume responsibility that the method of attachment and usage does not result in a safety hazard nor damage the welding equipment. Some of the factors to be considered are as follows:

1. Design capacity of trailer vs. weight of Lincoln equipment and likely additional attachments.
2. Proper support of, and attachment to, the base of the welding equipment so there will be no undue stress to the framework.
3. Proper placement of the equipment on the trailer to insure stability side to side and front to back when being moved and when standing by itself while being operated or serviced.
4. Typical conditions of use, i.e., travel speed; roughness of surface on which the trailer will be operated; environmental conditions.
5. Conformance with federal, state and local laws.⁽¹⁾

(1) Consult applicable federal, state and local laws regarding specific requirements for use on public highways.

VEHICLE MOUNTING

⚠ WARNING

Improperly mounted concentrated loads may cause unstable vehicle handling and tires or other components to fail.

- Only transport this Equipment on serviceable vehicles which are rated and designed for such loads.
- Distribute, balance and secure loads so vehicle is stable under conditions of use.
- Do not exceed maximum rated loads for components such as suspension, axles and tires.
- Mount equipment base to metal bed or frame of vehicle.
- Follow vehicle manufacture's instructions.

PRE-OPERATION ENGINE SERVICE

READ the engine operating and maintenance instructions supplied with this machine.

⚠ WARNING



GASOLINE
can cause fire
or explosion.

- Stop engine while fueling.
 - Do not smoke when fueling.
 - Keep sparks and flame away from tank.
 - Do not leave unattended while fueling.
 - Wipe up spilled fuel and allow fumes to clear before starting engine.
 - Do not overfill tank, fuel expansion may cause overflow.
- GASOLINE FUEL ONLY**

OIL



The RANGER® 250 is shipped with the engine crankcase filled with high quality SAE 10W-30 oil. Check the oil level before starting the engine. If it is not up to the full mark on the dip stick, add oil as required. Check the oil level every four hours of running time during the first 25 running hours. Refer to the engine Operator's Manual for specific oil recommendations and break-in information. The oil change interval is dependent on the quality of the oil and the operating environment. Refer to the Engine Operator's Manual for the proper service and maintenance intervals.

FUEL



⚠ CAUTION

USE GASOLINE FUEL ONLY

Fill the fuel tank with clean, fresh fuel. The capacity of the fuel tank is 12 gallons (45.4 liters). When the fuel gauge reads empty the tank contains approximately 2 gallons (7.6 liters) of reserve fuel.

NOTE: The fuel tank is mounted below the engine so a fuel shutoff valve is not required.

ENGINE COOLING SYSTEM

Air to cool the engine is drawn in lower set of louvers on the case back. It is important that the intake air is not restricted. Allow a minimum clearance of 2 feet (0.6m) from the case back to a vertical surface.

BATTERY CONNECTION

⚠ CAUTION

Use caution as the electrolyte is a strong acid that can burn skin and damage eyes.

The RANGER® 250 is shipped with the negative battery cable disconnected. Make certain that the RUN-STOP switch is in the STOP position. Remove the two screws from the rear battery tray using a screwdriver or a 3/8" socket. Attach the negative battery cable to the negative battery terminal and tighten using a 1/2" socket or wrench.

NOTE: This machine is furnished with a wet charged battery; if unused for several months, the battery may require a booster charge. Be careful to charge the battery with the correct polarity.

MUFFLER OUTLET PIPE

Using the clamp provided secure the outlet pipe to the outlet tube with the pipe positioned such that it will direct the exhaust in the desired direction. Tighten using a 9/16" socket or wrench.

SPARK ARRESTER

Some federal, state or local laws may require that gasoline or diesel engines be equipped with exhaust spark arresters when they are operated in certain locations where unarrested sparks may present a fire hazard. The standard muffler included with this welder does not qualify as a spark arrester. When required by local regulations, a suitable spark arrester, such as the K1898-1 must be installed and properly maintained.

CAUTION

An incorrect spark arrester may lead to damage to the engine or adversely affect performance.

HIGH FREQUENCY GENERATORS FOR TIG APPLICATIONS

The K930-2 TIG Module is suitable for use with the Ranger® 250. The Ranger® 250 and any high frequency generating equipment must be properly grounded. See the K930-2 Operating Manual for completed instructions on installation, operation, and maintenance.

REMOTE CONTROL

The Ranger® 250 is equipped with a 6-pin and a 14-pin connector. The 6 pin connector is for connecting the K857 or K857-1 Remote Control (optional) or for TIG welding, the K870 foot Amptrol or the K963-3 hand Amptrol.

When in the CC-STICK, PIPE, and CV-WIRE modes and when a remote control is connected to the Amphenol, the auto-sensing circuit in the Ranger® 250 automatically switches the OUTPUT control from control at the welder to remote control .

The 14-pin connector is used to directly connect a wire feeder or TIG Module (K930-2) control cable. In the CV-WIRE mode, the Ranger® 250 auto-sensing circuit automatically makes the Ranger® 250 Output Control inactive and the wire feeder voltage control active when the control cable is connected to the 14 pin connector.

NOTE: When a wire feeder with a built in welding voltage control is connected to the 14-pin connector, do not connect anything to the 6-pin connector.

ELECTRICAL CONNECTIONS MACHINE GROUNDING



Because this portable engine driven welder creates its own power, it is not necessary to connect its frame to an earth ground, unless the machine is connected to premises wiring (home, shop, etc.)

To prevent dangerous electric shock, other equipment to which this engine driven welder supplies power must:

WARNING

1. Be grounded to the frame of the welder using a grounded type plug.
2. Be double insulated.

Do not ground the machine to a pipe that carries explosive or combustible material.

When this welder is mounted on a truck or trailer, its frame must be electrically bonded to the metal frame of the vehicle, use a #8 or larger copper wire connected between the machine grounding stud and frame of the vehicle. When this engine driven welder is connected to premises wiring such as that in a home or shop, its frame must be connected to the system earth ground. See further connection instructions in the section entitled "Standby Power Connections" as well as the article on grounding in the latest U.S. National Electrical Code and the local code.

In general, if the machine is to be grounded, it should be connected with a #8 or larger copper wire to a solid earth ground such as a metal water pipe going into the ground for at least ten feet and having no insulated joints, or to the metal framework of a building which has been effectively grounded.

The U.S. National Electrical Code lists a number of alternate means of grounding electrical equipment. A machine grounding stud marked with the symbol  is provided on the front of the welder.

RANGER® 250



WELDING TERMINALS

The Ranger® 250 is equipped with a toggle switch for selecting "hot" welding terminal when in the "WELD TERMINALS ON" position or "cold" welding terminal when in the "REMOTELY CONTROLLED" position.

WELDING OUTPUT CABLES

With the engine off connect the electrode and work cables to the output studs. The welding process dictates the polarity of the electrode cable. These connections should be checked periodically and tightened with a 3/4" wrench.

Table A.1 lists recommended cable sizes and lengths for rated current and duty cycle. Length refers to the distance from the welder to the work and back to the welder. Cable diameters are increased for long cable lengths to reduce voltage drops.

TABLE A-1

TOTAL COMBINED LENGTH OF ELECTRODE AND WORK CABLES	
Cable Length	Cable Size for 250 Amps 100% Duty Cycle
0-100 Ft. (0-31 meters)	1 AWG
100-150 Ft. (30-46 meters)	1 AWG
150-200 Ft. (46-61 meters)	1/0 AWG

CABLE INSTALLATION

Install the welding cables to your RANGER® 250 as follows.

1. The engine must be OFF to install welding cables.
2. Remove the flanged nuts from the output terminals.
3. Connect the electrode holder and work cables to the weld output terminals. The terminals are identified on the case front.
4. Tighten the flanged nuts securely.
5. Be certain that the metal piece you are welding (the "work") is properly connected to the work clamp and cable.
6. Check and tighten the connections periodically.

CAUTION

- Loose connections will cause the output terminals to overheat. The terminals may eventually melt.
- Do not cross the welding cables at the output terminal connection. Keep the cables isolated and separate from one another.

AUXILIARY POWER RECEPTACLES

The auxiliary power of the RANGER® 250 consists of two 20 Amp-120 VAC (5-20R) duplex receptacles and one 50 Amp 120/240 VAC (14-50R) receptacle. The 240 VAC receptacle can be split for single phase 120 VAC operation.

The auxiliary power capacity is 10,500 Watts Peak, 9500 Watts Continuous of 60 Hz, single phase power. The auxiliary power capacity rating in watts is equivalent to volt-amperes at unity power factor. The max permissible current of the 240 VAC output is 40 Amps. The 240 VAC output can be split to provide two separate 120 VAC outputs with a max permissible current of 40 Amps per output to two separate 120 VAC branch circuits (these circuits cannot be paralleled). Output voltage is within $\pm 10\%$ at all loads up to rated capacity. All auxiliary power is protected by circuit breakers.

The 120 V auxiliary power receptacles should only be used with three wire grounded type plugs or approved double insulated tools with two wire plugs. The current rating of any plug used with the system must be at least equal to the current capacity of the associated receptacle.

NOTE: The 240 V receptacle has two 120 V circuits, but are of opposite polarities and cannot be paralleled.

STANDBY POWER CONNECTIONS

The RANGER® 250 is suitable for temporary, standby or emergency power using the engine manufacturer's recommended maintenance schedule.

The RANGER® 250 can be permanently installed as a standby power unit for 240 VAC, 3 wire, single phase, 40 amp service. Connections must be made by a licensed electrician who can determine how the 120/240 VAC power can be adapted to the particular installation and comply with all applicable electrical codes.

1. Install the double-pole, double-throw switch between the power company meter and the premises disconnect. Switch rating must be the same or greater than the customer's premises disconnect and service over current protection.
2. Take necessary steps to assure load is limited to the capacity of the RANGER® 250 by installing a 40 amp, 240 VAC double pole circuit breaker. Maximum rated load for each leg of the 240 VAC auxiliary is 40 amperes. Loading above the rated output will reduce output voltage below the allowable - 10% of rated voltage which may damage appliances or other motor-driven equipment and may result in overheating of the RANGER® 250 engine and/or alternator windings.
3. Install a 50 amp, 120/240 VAC plug (NEMA Type 14-50) to the double-pole circuit breaker using No. 6, 4 conductor cable of the desired length. (The 50 amp, 120/240 VAC plug is available in the optional K802R plug kit or as part number T12153-9.)
4. Plug this cable into the 50 Amp, 120/240 Volt receptacle on the RANGER® 250 case front.

RANGER® 250



CONNECTION OF RANGER® 250 TO PREMISES

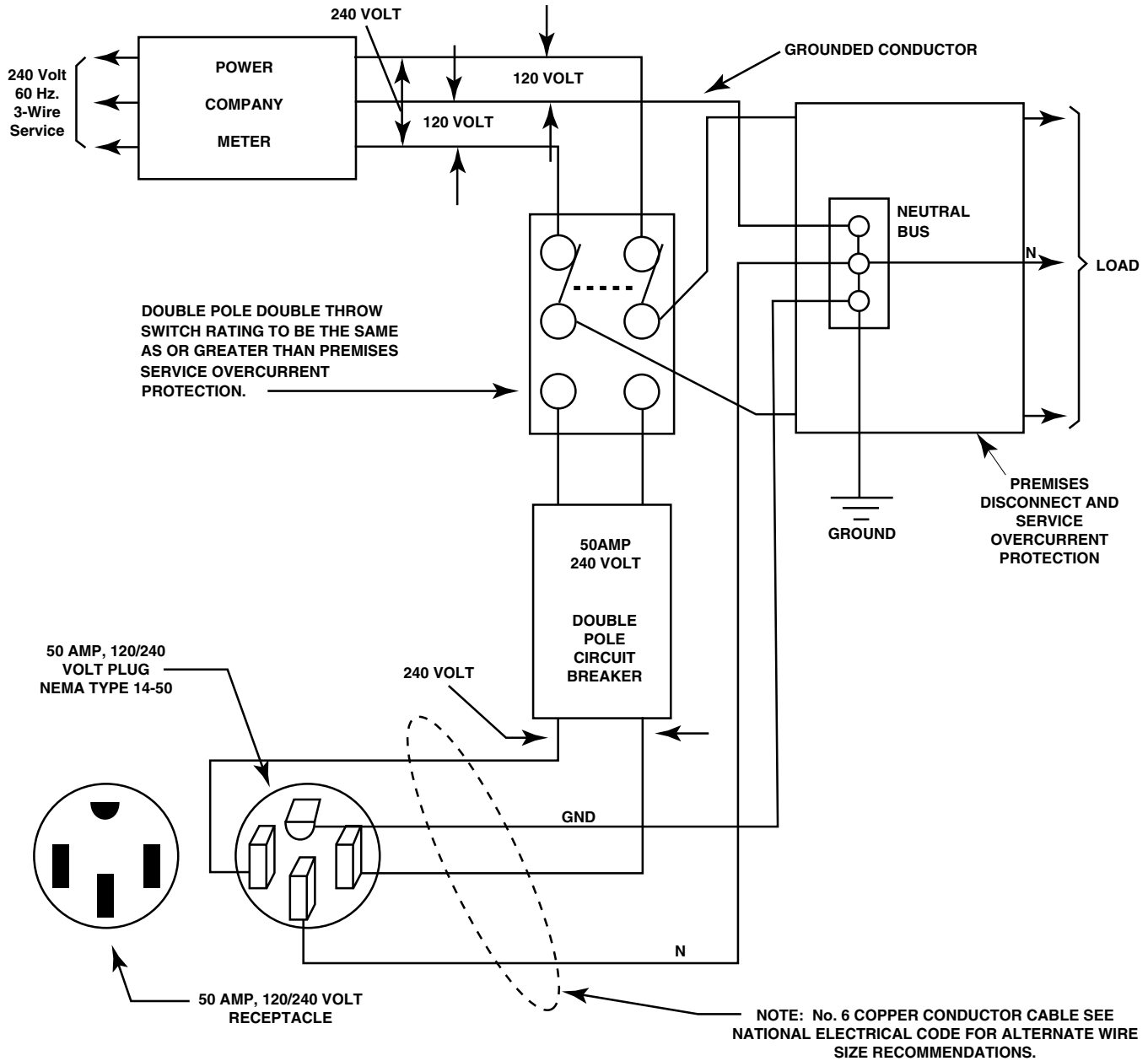

⚠ WARNING

- Only a licensed, certified, trained electrician should install the machine to a premises or residential electrical system. Be certain that:
 - The installation complies with the National Electrical Code and all other applicable electrical codes.
 - The premises is isolated and no feedback into the utility system can occur. Certain state and local laws require the premises to be isolated before the generator is linked to the premises. Check your state and local requirements.
 - A double pole, double throw transfer switch in conjunction with the properly rated double throw circuit breaker is connected between the generator power and the utility meter.

RANGER® 250

LINCOLN®
ELECTRIC

CONNECTION OF LINCOLN ELECTRIC WIRE FEEDERS

Connection of LN-7 or LN-8 to the Ranger® 250

1. Shut the welder off.
2. Connect the LN-7 or LN-8 per instructions on the appropriate connection diagram in Section F
3. Set the "WIRE FEEDER VOLTMETER" switch to either "+" or "-" as required by the electrode being used.
4. Set the "MODE" switch to the "CV WIRE " position.
5. Set the "ARC CONTROL" knob to "0" initially and adjust to suit.
- 6 Set the "WELD TERMINALS" switch to the "REMOTELY CONTROLLED" position.
7. Set the "IDLE" switch to the "HIGH" position.

Connection of LN-15 to the Ranger® 250

These connections instructions apply to both the LN-15 Across The-Arc and Control Cable models. The LN-15 has an internal contactor and the electrode is not energized until the gun trigger is closed. When the gun trigger is closed the wire will begin to feed and the welding process is started.

- Shut the welder off.
 - For electrode Positive, connect the electrode cable to the "+" terminal of the welder and work cable to the "-" terminal of the welder. For electrode Negative, connect the electrode cable to the "-" terminal of the welder and work cable to the "+" terminal of the welder.
- **Across The-Arc Model:**

Attach the single lead from the front of the LN-15 to work using the spring clip at the end of the lead. This is a control lead to supply current to the wire feeder motor; it does not carry welding current.

Set the "WELD TERMINALS" switch to "WELD TERMINALS ON"

• Control Cable Model:

Connect Control Cable between Engine Welder and Feeder.

Set the "WELD TERMINALS" switch to "REMOTELY CONTROLLED"

- Set the MODE switch to the "CV-WIRE " position.
- Set the "WIRE FEEDER VOLTMETER" switch to either "+" or "-" as required by the electrode polarity being used.
- Set the "ARC CONTROL" knob to "0" initially and adjust to suit.
- Set the "IDLE" switch to the "AUTO" position

Connection of the LN-25 to the Ranger® 250

The LN-25 with or without an internal contactor may be used with the Ranger® 250. See the appropriate connection diagram in Section F.

1. Shut the welder off.
2. For electrode Positive, connect the electrode cable from the LN-25 to the "+" terminal of the welder and work cable to the "-" terminal of the welder. For electrode Negative, connect the electrode cable from the LN-25 to the "-" terminal of the welder and work cable to the "+" terminal of the welder.
3. Attach the single lead from the front of the LN-25 to work using the spring clip at the end of the lead. This is a control lead to supply current to the wire feeder motor; it does not carry welding current.
4. Set the MODE switch to the "CV-WIRE " position.
5. Set the "WELD TERMINALS" switch to "WELD TERMINALS ON"
6. Set the "ARC CONTROL" knob to "0" initially and adjust to suit.

7. Set the "IDLE" switch to the "AUTO" position. When not welding, the Ranger® 250 engine will be at the low idle speed. If you are using an LN-25 with an internal contactor, the electrode is not energized until the gun trigger is closed.
8. When the gun trigger is closed, the current sensing circuit will cause the Ranger® 250 engine to go to the high idle speed, the wire will begin to feed and the welding process started. When welding is stopped, the engine will revert to low idle speed after approximately 12 seconds unless welding is resumed.

Connection of LN-742, K487-25 Spool Gun, and Cobramatic to Ranger® 250

1. Shut the welder off.
2. Connect per instructions on the appropriate connection diagram in Section F.

SAFETY PRECAUTIONS

Read and understand this entire section before operating your Ranger® 250.

Do not attempt to use this equipment until you have thoroughly read all operating and maintenance manuals supplied with your machine. They include important safety precautions, detailed engine starting, operating and maintenance instructions and parts lists.



ELECTRIC SHOCK can kill.

- Do not touch electrically live parts such as output terminals or internal wiring.

- Insulate yourself from the work and ground.

- Always wear dry insulating gloves.



ENGINE EXHAUST can kill.

- Use in open, well ventilated areas or vent exhaust outside

- Do not stack anything near the engine.



MOVING PARTS can injure.

- Do not operate with doors open or guards off.

- Stop engine before servicing.

- Keep away from moving parts

- Only qualified personnel should operate this equipment.

ADDITIONAL SAFETY PRECAUTIONS

Always operate the welder with the hinged door closed and the side panels in place as these provide maximum protection from moving parts and insure proper cooling air flow.

GENERAL DESCRIPTION

The Ranger® 250 is a gasoline engine powered DC multi-process welding power source and 120 / 240 volt AC power generator. The engine drives a generator that supplies three phase power for the DC welding circuit and single phase power for the AC auxiliary outlets. The DC welding control system uses state of the art Chopper Technology  for superior welding performance. The Ranger® 250 is **not recommended** for pipe thawing.

DESIGN FEATURES

ENGINE OPERATION

Before Starting the Engine:

1. Be sure the machine is on a level surface.
2. Open top engine door and remove the engine oil dipstick and wipe it with a clean cloth. Reinsert the dipstick and check the level on the dipstick. 
3. Add oil (if necessary) to bring the level up to the full mark. Do not overfill. Close engine door.
4. See Engine Owner's Manual for specific oil recommendations.

ADD FUEL



WARNING

GASOLINE can cause fire or explosion.



- Stop engine when fueling.

- Do not smoke when fueling.

- Do not overfill tank.

- Avoid contact with skin or breathing of vapor.

- Keep sparks and flame away from tank.

1. Remove the fuel tank cap.
2. Fill the tank approximately 4 inches (100mm) from the top of the filler neck to allow for fuel expansion **DO NOT FILL THE TANK TO THE POINT OF OVERFLOW.**
3. Replace the fuel cap and tighten securely.
4. See Engine Owner's Manual for specific fuel recommendations.

RANGER® 250



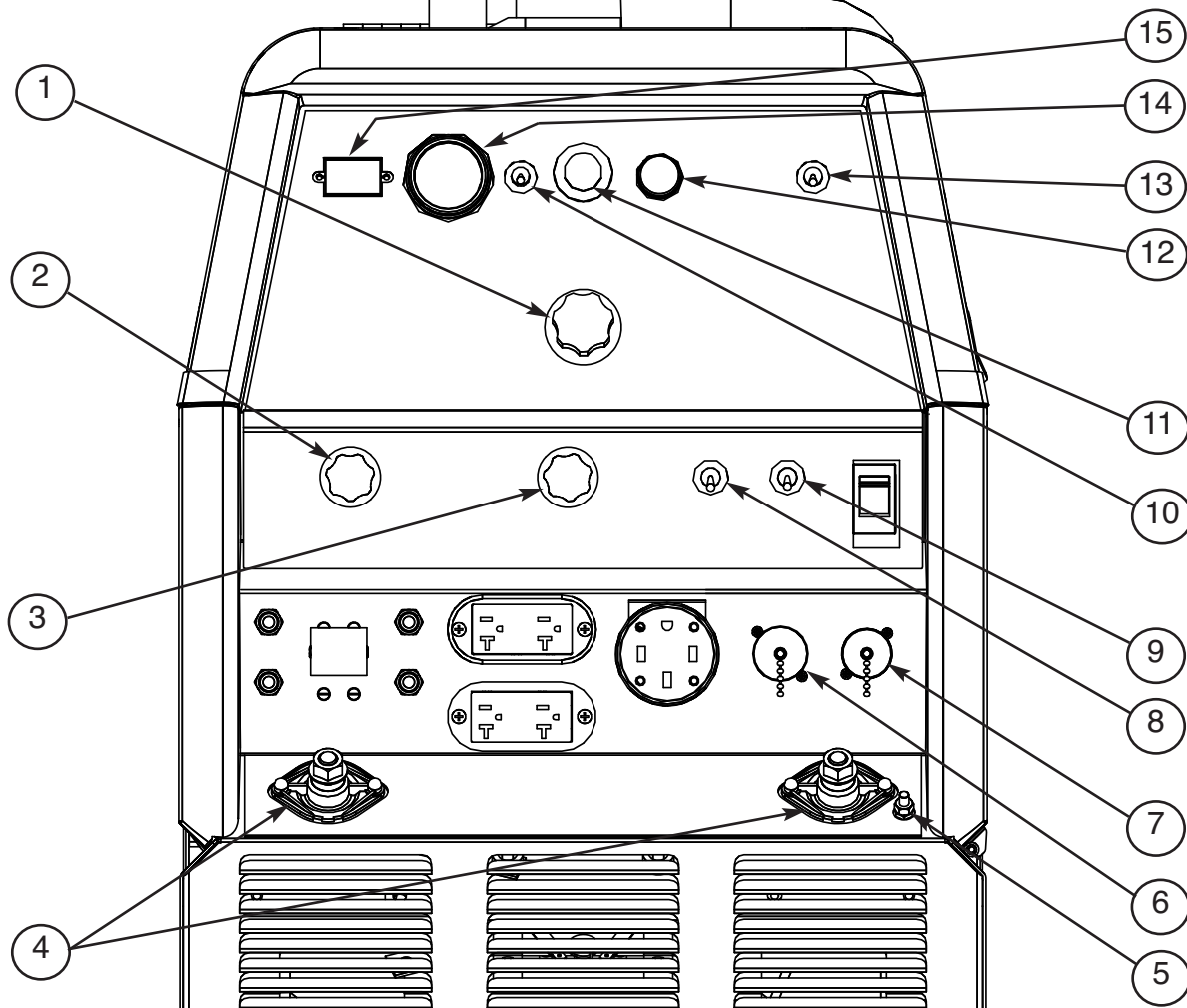

WELDING CONTROLS:

1. OUTPUT CONTROL: The CONTROL dial provides continuous control of the welding current or welding voltage depending on the selected welding mode. This control is not active in the CC-STICK, DOWN HILL PIPE, and CV-WIRE modes when a remote control or wire feeder with remote control is connected to either the 6 pin or 14 pin Amphenol.

2. WELD MODE SELECTOR SWITCH:

(Provides four selectable welding modes)

- CV-WIRE
- DOWN HILL PIPE
- CC-STICK
- TOUCH START TIG

3. ARC CONTROL :

The ARC CONTROL WIRE/STICK dial is active in the WIRE, STICK and DOWN HILL PIPE modes, and has different functions in these modes. This control is not active in the TIG mode.

CC-STICK mode: In this mode, the ARC CONTROL dial sets the short circuit current (arc-force) during stick welding to adjust for a soft or crisp arc. Increasing the number from -10(soft) to +10(crisp) increases the short circuit current and prevents sticking of the electrode to the plate while welding. This can also increase spatter. It is recommended that the ARC CONTROL be set to the minimum number without electrode sticking. Start with a setting at 0.

DOWNHILL PIPE MODE: In this mode, the ARC CONTROL dial sets the short circuit current (arc force) during stick welding to adjust for a soft or a more forceful digging arc (crisp). Increasing the number from -10(soft) to +10(crisp) increases the short circuit current which results in a more forceful digging arc. Typically a forceful digging arc is preferred for root and hot passes. A softer arc is preferred for fill and cap passes where weld puddle control and deposition ("stacking" of iron) are key to fast travel speeds. It is recommended that the ARC CONTROL be set initially at 0.

CV-WIRE mode: In this mode, turning the ARC CONTROL clockwise from -10 (soft) to +10 (crisp) changes the arc from soft and washed-in to crisp and narrow. It acts as an inductance control. The proper setting depends on the procedure and operator preference. Start with a setting at 0.

RANGER® 250

LINCOLN
ELECTRIC

4. WELD OUTPUT TERMINALS WITH FLANGE NUT:

Provides a connection point for the electrode and work cables. Output stud covers provided on code 11270 and above.

5. GROUND STUD: (graphic)

Provides a connection point for connecting the machine case to earth ground for the safest grounding procedure.

6. 14-PIN CONNECTOR:

For attaching wire feeder control cables to the Ranger® 250. Includes contactor closure circuit, auto-sensing remote control circuit, and 120V and 42V power. The remote control circuit operates the same as the 6-Pin Amphenol.

7. 6-PIN CONNECTOR:

For attaching optional remote control equipment. When in the CC-STICK, PIPE, and CV-WIRE modes and when a remote control is connected to the Amphenol, the auto-sensing circuit in the Ranger® 250 automatically switches the OUTPUT control from control at the welder to remote control .

When using the TOUCH START TIG mode with a TIG Module connected to the Ranger® 250, the OUTPUT control on the front of the Ranger® 250 is used to set the maximum current range of the CURRENT CONTROL on the TIG Module.

8. WELD TERMINALS CONTROL SWITCH:

In the WELD TERMINALS ON position, the output is electrically hot all the time. In the REMOTELY CONTROLLED position, the output is controlled by a wire feeder or amptrol device, and is electrically off until a remote switch is depressed.

9. WIRE FEEDER VOLTMETER SWITCH:

Matches the polarity of the wire feeder voltmeter to the polarity of the electrode.

ENGINE CONTROLS:

10. RUN/STOP SWITCH - RUN position energizes the engine prior to starting. STOP position stops the engine. The oil pressure interlock switch prevents battery drain if the switch is left in the RUN position and the engine is not operating.

11. CHOKE - When pulled out, it closes the choke valve on the engine carburetor for quick starting.

12. START PUSH BUTTON - Energizes the starter motor to crank the engine.

13. IDLER SWITCH- Has two positions as follows:

- 1) In the HIGH position, the engine runs at the high idle speed controlled by the engine governor.
- 2) In the AUTO position, the idler operates as follows:

- When switched from HIGH to AUTO or after starting the engine, the engine will operate at full speed for approximately 12 seconds and then go to low idle speed.
- When the electrode touches the work or power is drawn for lights or tools (approximately 100 Watts minimum), the engine accelerates and operates at full speed.
- When welding ceases or the AC power load is turned off, a fixed time delay of approximately 12 seconds starts. If the welding or AC power load is not restarted before the end of the time delay, the idler reduces the engine speed to low idle speed.
- The engine will automatically return to high idle speed when there is welding load or AC power load reapplied.

14. ELECTRIC FUEL GAUGE-

The electric fuel gauge gives accurate and reliable indication as to how much fuel is in the fuel tank.

15. ENGINE HOUR METER –

Displays the total time that the engine has been running. This meter is useful for scheduling prescribed maintenance.

STARTING AND STOPPING THE ENGINE

1. Remove all plugs connected to the AC power receptacles.
2. Set IDLER switch to AUTO. 
3. Set the RUN/STOP switch to RUN.
4. Pull the choke to the full out position.
5. Press and hold the engine START button until the engine starts.
6. Release the engine START button when the engine starts.
7. Push the choke back in.
8. The engine will run at high idle speed for approximately 12 seconds and then go to low idle speed. Allow the engine to warm up at low idle for several minutes before applying a load and/or switching to high idle. Allow a longer warm up time in cold weather.

RANGER® 250



⚠ CAUTION

Operating the starter motor for more than 5 seconds can damage the motor. If the engine fails to start, release the switch and wait 10 seconds before operation the starter again. Do NOT push the START button while the engine is running because this can damage the ring gear and/or the starter motor.

NOTE: When starting a Ranger® 250 for the first time, or after an extended period of time of not operating, it will take longer than normal because the fuel pump has to fill the fuel line and carburetor.

FOR SUBARU ROBIN ENGINES

If engine is already warm starting should be done with one half or no choke applied.

STOPPING THE ENGINE

Remove all welding and auxiliary power loads and allow the engine to run at low idle speed for a few minutes to cool the engine.

Stop the engine by placing the RUN-STOP in the STOP position.

NOTE: A fuel shut off valve is not required on the Ranger® 250 because the fuel tank is mounted below the engine.

WELDER OPERATION

DUTY CYCLE is the percentage of time the load is being applied in a 10 minute period. For example, a 60% duty cycle represents 6 minutes of load and 4 minutes of no load in a 10 minute period.

DC STICK WELDING

The Ranger® 250 can be used with a broad range of DC stick electrodes.

The MODE switch provides two stick welding settings as follows:

CONSTANT CURRENT (CC-STICK) WELDING

The CC-STICK position of the MODE switch is designed for flat, horizontal and vertical-up welding with all types of electrodes, especially low hydrogen. The output CONTROL dial adjusts the full output range for stick welding.

The ARC CONTROL dial sets the short circuit current (arc-force) during stick welding to adjust for a soft or crisp arc. Increasing the number from -10(soft) to +10(crisp) increases the short circuit current and prevents sticking of the electrode to the plate while welding. This can also increase spatter. It is recommended that the ARC CONTROL be set to the minimum number without electrode sticking. Start with the dial set at 0.

DOWNHILL PIPE WELDING

This slope controlled setting is intended for "out-of-position" and "down hill" pipe welding where the operator would like to control the current level by changing the arc length. The output CONTROL dial adjusts the full output range for pipe welding. The ARC CONTROL dial sets the short circuit current (arc-force) during stick welding to adjust for a soft or more forceful digging arc (crisp). Increasing the number from -10(soft) to +10(crisp) increases the short circuit current which results in a more forceful digging arc. Typically a forceful digging arc is preferred for root and hot passes. A softer arc is preferred for fill and cap passes where weld puddle control and deposition ("stacking" of iron) are key to fast travel speeds. This can also increase spatter. It is recommended that the ARC CONTROL be set to the minimum number without electrode sticking. Start with the dial set at 0.

TYPICAL RANGER® 250 FUEL CONSUMPTION

	Kohler CH23S 23HP @ 3600 RPM Gal./Hr (Liters/Hr)	Subaru Robin EH65 22HP @ 3600 RPM Gal./Hr (Liters/Hr)	CH23/EH65 HOURS Approx. Run Time for 12 Gallon Tank (Hours)
Low Idle - No Load 2400 R.P.M.	0.6 (2.3)	0.5 (1.9)	20 / 24
High Idle - No Load 3700 R.P.M.	0.8 (3.0)	0.8 (3.0)	15 / 15
DC Weld Output 250 Amps @ 28 Volts	1.40 (5.3)	1.6 (5.9)	8.6 / 7.5
Auxiliary Power 9,500 Watts Continuous	1.64 (6.2)	1.9 (7.2)	7.3 / 6.3

RANGER® 250



TIG WELDING

The TOUCH START TIG setting of the MODE switch is for DC TIG (Tungsten Inert Gas) welding. To initiate a weld, the CONTROL dial is first set to the desired current and the tungsten is touched to the work. During the time the tungsten is touching the work there is very little voltage or current and, in general, no tungsten contamination. Then, the tungsten is gently lifted off the work in a rocking motion, which establishes the arc.

The ARC CONTROL is not active in the TIG mode. To STOP a weld, simply pull the TIG torch away from the work. When the arc voltage reaches approximately 30 Volts the arc will go out and the machine will reset the current to the Touch Start level. To reinitiate the arc, retouch the tungsten to the work and lift. Alternatively, the weld can be stopped by releasing the Amptrol or arc start switch.

The Ranger® 250 can be used in a wide variety of DC TIG welding applications. In general the 'Touch Start' feature allows contamination free starting without the use of a Hi-frequency unit. If desired, the K930-2 TIG Module can be used with the Ranger® 250. The settings are for reference.

Ranger® 250 settings when using the K930-2 TIG Module with an Amptrol or Arc Start Switch:

- Set the MODE Switch to the TOUCH START TIG setting.
- Set the "IDLER" Switch to the "AUTO" position.
- Set the "WELDING TERMINALS" switch to the "REMOTELY CONTROLLED" position. This will keep the "Solid State" contactor open and provide a "cold" electrode until the Amptrol or Arc Start Switch is pressed.

When using the TIG Module, the OUTPUT control on the Ranger® 250 is used to set the maximum range of the CURRENT CONTROL on the TIG Module or an Amptrol if connected to the TIG Module.

WIRE WELDING-CV

Connect a wire feeder to the Ranger® 250 according to the instructions in INSTALLATION INSTRUCTIONS Section.

The Ranger® 250 in the CV-WIRE mode, permits it to be used with a broad range of flux cored wire (Innershield and Outershield) electrodes and solid wires for MIG welding (gas metal arc welding). Welding can be finely tuned using the ARC CONTROL. Turning the ARC CONTROL clockwise from -10 (soft) to +10 (crisp) changes the arc from soft and washed-in to crisp and narrow. It acts as an inductance control. The proper setting depends on the procedure and operator preference. Start with the dial set at 0.

Listed below are some wires suitable for use on this machine:

- Innershield - NR-311, NS-3M, NR-207, NR-203 Ni 1%.
- Outershield - OS-70, OS-71M.
- Solid wires for MIG welding - .035 (0.9 mm), and .045 (1.1 mm), Super Arc L-50 and L-56, .035 (0.9 mm) and .045 (1.1 mm) Blue Max MIG 308 LS.

Contact your local authorized Lincoln Electric Distributor or the Lincoln Electric Company for specific wires used on certain applications with this machine.

TYPICAL CURRENT RANGES (1) FOR TUNGSTEN ELECTRODES(2)						
Tungsten Electrode Diameter in. (mm)	DCEN (-)	DCEP (+)	Approximate Argon Gas Flow Flow Rate C.F.H. (l /min.)		TIG TORCH Nozzle Size (4), (5)	
	1%, 2% Thoriated Tungsten	1%, 2% Thoriated Tungsten	Aluminum	Stainless Steel		
.010 (.25)	2-15	(3)	3-8 (2-4)	3-8 (2-4)	#4, #5, #6	
0.020 (.50)	5-20	(3)	5-10 (3-5)	5-10 (3-5)		
0.040 (1.0)	15-80	(3)	5-10 (3-5)	5-10 (3-5)		
1/16 (1.6)	70-150	10-20	5-10 (3-5)	9-13 (4-6)	#5, #6	
3/32 (2.4)	150-250	15-30	13-17 (6-8)	11-15 (5-7)	#6, #7, #8	
1/8 (3.2)	250-400	25-40	15-23 (7-11)	11-15 (5-7)		
5/32 (4.0)	400-500	40-55	21-25 (10-12)	13-17 (6-8)	#8, #10	
3/16 (4.8)	500-750	55-80	23-27 (11-13)	18-22 (8-10)		
1/4 (6.4)	750-1000	80-125	28-32 (13-15)	23-27 (11-13)		

(1) When used with argon gas. The current ranges shown must be reduced when using argon/helium or pure helium shielding gases.

(2) Tungsten electrodes are classified as follows by the American Welding Society (AWS):

Pure	EWP
1% Thoriated	EWTh-1
2% Thoriated	EWTh-2

Though not yet recognized by the AWS, Ceriated Tungsten is now widely accepted as a substitute for 2% Thoriated Tungsten in AC and DC applications.

(3) DCEP is not commonly used in these sizes.

(4) TIG torch nozzle "sizes" are in multiples of 1/16ths of an inch:

# 4 = 1/4 in.	(6 mm)
# 5 = 5/16 in.	(8 mm)
# 6 = 3/8 in.	(10 mm)
# 7 = 7/16 in.	(11 mm)
# 8 = 1/2 in.	(12.5 mm)
# 10 = 5/8 in.	(16 mm)

(5) TIG torch nozzles are typically made from alumina ceramic. Special applications may require lava nozzles, which are less prone to breakage, but cannot withstand high temperatures and high duty cycles.

RANGER® 250



ARC GOUGING

The Ranger® 250 can be used for limited arc gouging. For optimal performance, set the MODE switch to CC-STICK and the ARC CONTROL to +10.

Set the CONTROL knob to adjust output current to the desired level for the gouging electrode being used according to the ratings in the following table.

Carbon Diameter	Current Range (DC, electrode positive)
1/8" (3.2mm)	60-90 Amps
5/32" (4.0mm)	90-150 Amps
3/16" (4.8mm)	200-250 Amps

AUXILIARY POWER:

Start the engine and set the IDLER control switch to the desired operating mode. Full power is available regardless of the welding control settings providing no welding current is being drawn.

The auxiliary power of the RANGER® 250 consists of two 20 Amp-120 VAC (5-20R) duplex receptacles and one 50 Amp 120/240 VAC (14-50R) receptacle. The 240 VAC receptacle can be split for single phase 120 VAC operation.

The auxiliary power capacity is 10,500 Watts Peak, 9500 Watts Continuous of 60 Hz, single phase power. The auxiliary power capacity rating in watts is equivalent to volt-amperes at unity power factor. The max permissible current of the 240 VAC output is 40 Amps. The 240 VAC output can be split to provide two separate 120 VAC outputs with a max permissible current of 40 Amps per output to two separate 120 VAC branch circuits (these circuits cannot be paralleled). Output voltage is within $\pm 10\%$ at all loads up to rated capacity. All auxiliary power is protected by circuit breakers.

The 120 V auxiliary power receptacles should only be used with three wire grounded type plugs or approved double insulated tools with two wire plugs. The current rating of any plug used with the system must be at least equal to the current capacity of the associated receptacle.

NOTE: The 240 V receptacle has two circuits, each of which measure 120 V to neutral but are of opposite polarities and cannot be paralleled.

Simultaneous Welding and Auxiliary Power Loads

The above auxiliary power ratings are with no welding load. Simultaneous welding and power loads are specified in the following table. The permissible currents shown assume that current is being drawn from either the 120 VAC or 240 VAC supply (not both at the same time).

Ranger® 250 Simultaneous Welding and Power Loads

Welding Output-Amps	Permissible Power-Watts (Unity Power Factor)	Permissible Auxiliary Current in -Amps	
		@120 VAC *	@ 240 VAC
0	9500	80**	40
100	7100	60**	30
150	5600	46**	23
200	4200	36	18
250	2300	20	10

* Each duplex receptacle is limited to 20 amps.

** Not to exceed 40 A per 120 VAC branch circuit when splitting the 240 VAC output.

Ranger® 250 Extension Cord Length Recommendations

(Use the shortest length extension cord possible sized per the following table.)

Current Voltage (Amps) Volts	Load (Watts)	Maximum Allowable Cord Length in ft. (m) for Conductor Size											
		14 AWG		12 AWG		10 AWG		8 AWG		6 AWG		4 AWG	
15 120	1800	30	(9)	40	(12)	75	(23)	125	(38)	175	(53)	300	(91)
20 120	2400			30	(9)	50	(15)	88	(27)	138	(42)	225	(69)
15 240	3600	60	(18)	75	(23)	150	(46)	225	(69)	350	(107)	600	(183)
20 240	4800			60	(18)	100	(30)	175	(53)	275	(84)	450	(137)
40 240	9500					50	(15)	90	(27)	150	(46)	225	(69)

Conductor size is based on maximum 2.0% voltage drop.

RANGER® 250



RECOMMENDED OPTIONAL EQUIPMENT

K957-1 HEAVY DUTY, TWO WHEEL TRAILER FOR SMALL WELDERS - For road, off-road and in-plant and yard towing. (For highway use, consult applicable federal, state and local laws regarding requirements for brakes, lights, fenders, etc.). Order:

K957-1 Trailer
 K958-1 Ball Hitch
 K958-2 Lunette Eye Hitch
 K959-2 Fender & Light Kit
 K965-1 Cable Storage Rack

K1737-1 FOUR WHEEL ALL-TERRAIN UNDER-CARRIAGE - For moving by hand at construction sites. Heavy duty puncture resistant pneumatic tires.

K1770-1 UNDERCARRIAGE (FACTORY)

For moving by hand on a smooth surface. Heavy duty puncture resistant pneumatic tires and front caster. One or two gas cylinders can be mounted on the rear of the undercarriage with the installation of K1745-1 Cylinder Holder(s).

K1739-1 CABLE CARRIER KIT - For use on K1737-1 and K1770-1 Undercarriages.

K1745-1 WELDING GAS CYLINDER LPG TANK HOLDER - For use on K1770-1 Undercarriage. One or two may be installed on an undercarriage.

K1788-1 ROLL CAGE - Gives added damage protection.

K886-2 CANVAS COVER - Protects machine when not in use.

K1898-1 SPARK ARRESTER - Mounts inside exhaust pipe.

K704 ACCESSORY SET - Includes 35 ft. (10m) of electrode cable and 30 ft. (9.1m) of work cable, head-shield, work clamp electrode holder. Cables are rated at 400 amps, 100% duty cycle.

K857 25 ft (7.5m) or **K857-1** 100 ft. (30.4m) **REMOTE CONTROL** - Portable control provides same dial range as the output control on the welder. Has a convenient 6 pin plug for easy connection to the welder.

K1690-1 GFCI RECEPTACLE KIT - Includes one UL approved 120V ground fault circuit interrupter duplex type receptacle with cover and installation instructions. Replaces the factory installed 120V duplex receptacle. Each receptacle of the GFCI Duplex is rated at 20 Amps, the maximum total current from the GFCI Duplex is limited to the 20 Amps. Two kits are required.

K802N POWER PLUG KIT

Provides four 120 volt plugs rated at 20 amps each and one dual voltage, full KVA plug rated at 120/240 volts, 50 amps.

K802R POWER PLUG KIT

Provides four 120 volt plugs rated at 15 amps each and one dual voltage, full KVA plug rated at 120/240 volts, 50 amps.

T12153-9 50 AMP, 120/240V POWER PLUG

K1816-1 FULL KVA ADAPTER KIT

Plugs into the 120/240V NEMA 14-50R receptacle on the case front (which accepts 4-prong plugs) and converts it to a NEMA 6-50R receptacle, (which accepts 3-prong plugs.)

TIG Welding

K1783-9 TIG Torch PTA-26V (25ft.)
K963-3 Hand Amptrol
K870 Foot Amptrol
KP509 Magnum Parts Kit

Spool Gun

K487-25 Magnum Spool Gun
K488 Magnum Control Module

K691-10 Input Cable

SAFETY PRECAUTIONS

⚠ WARNING

- Have qualified personnel do all maintenance and troubleshooting work.
- Turn the engine off before working inside the machine or servicing the engine.
- Remove guards only when necessary to perform maintenance and replace them when the maintenance requiring their removal is complete. If guards are missing from the machine, obtain replacements from a Lincoln Distributor. (See Operating Manual Parts List.)

Read the Safety Precautions in the front of this manual and in the Engine Owner's Manual before working on this machine.

Keep all equipment safety guards, covers, and devices in position and in good repair. Keep hands, hair, clothing, and tools away from the gears, fans, and all other moving parts when starting, operating, or repairing the equipment.

Routine Maintenance

At the end of each day's use, refill the fuel tank to minimize moisture condensation in the tank. Running out of fuel tends to draw dirt into the fuel system. Also, check the crankcase oil level and add oil if indicated.

KOHLER ENGINE

FREQUENCY	MAINTENANCE REQUIRED
Daily or Before Starting Engine	<ul style="list-style-type: none"> • Fill fuel tank. • Check oil level. • Check air cleaner for dirty, loose, or damaged parts. • Check air intake and cooling areas, clean as necessary.
5 Hours	<ul style="list-style-type: none"> • First Oil Change
Every 25 Hours	<ul style="list-style-type: none"> • Service air pre-cleaner..
Every 100 Hours Every 100 Hours Every 100 Hours	<ul style="list-style-type: none"> • Change engine oil. ⁽¹⁾ • Replace fuel filter element. • Clean or replace air filter element. ⁽¹⁾
Every 100 Hours Every 200 Hours Every 200 Hours	<ul style="list-style-type: none"> • Spark Arrester • Replace oil filter. ⁽¹⁾ • Check spark plug and gap
	<ul style="list-style-type: none"> • Check fuel lines and clamps.

(1) Service more frequently when used in dusty areas and/or at high ambient temperatures.

SUBARU ROBIN ENGINE

FREQUENCY	MAINTENANCE REQUIRED
Daily or Before Starting Engine	<ul style="list-style-type: none"> • Fill fuel tank. • Check oil level. • Check air cleaner for dirty, loose, or damaged parts. • Check air intake and cooling areas, clean as necessary. • Inspect for loose hardware and retighten. • Check for fuel leakage from fuel system. Repair if needed.
After initial 20 Hours	<ul style="list-style-type: none"> • Change oil and oil filter.
Every 50 Hours	<ul style="list-style-type: none"> • Clean spark plugs. • Clean outer element of air cleaner.
Every 100 Hours	<ul style="list-style-type: none"> • Change engine oil. ⁽¹⁾
Every 200 Hours	<ul style="list-style-type: none"> • Clean fuel strainer. • Replace air cleaner assembly. ⁽¹⁾ • Inspect, clean, and re-gap Spark Plugs. • Change engine oil filter. ⁽¹⁾
Every 500 Hours	<ul style="list-style-type: none"> • Clean Carburetor. • Clean cylinder head. • Adjust engine valve clearance. • Replace spark plugs.
Every 1000 Hours	<ul style="list-style-type: none"> • Replace fuel lines and filter.

(1) Service more frequently when used in dusty areas and/or at high ambient temperatures.

ENGINE MAINTENANCE COMPONENTS

ITEM	MAKE AND PART NUMBER	
	KOHLER CH23S ENGINE Code Numbers 11401 and above	SUBARU ROBIN EH65 ENGINE Code Number 11422 and above
Oil Filter	Kohler 12 050 01, Fram PH8172	Subaru Robin 248-65801-00, Fram PH4967
Air Filter Element	Kohler 47 083 03, Fram CA79	Subaru Robin 263-32610-A1
Air Filter Pre-Cleaner	Kohler 24 083 02	N/A
Fuel Filter	Kohler 24 050 13	Subaru Robin 011-00600-20
Spark Plug	Champion RC12YC (.030" Gap)	Subaru Robin X65-01407-30, NGK BPR4EY
Battery	BCI Group 58 (435 CCA)	BCI Group 58 (435 CCA)

RANGER® 250



ENGINE OIL CHANGE

Drain the oil while the engine is warm to assure rapid and complete draining.

- Remove the oil filler cap and dipstick. Remove the yellow cap from the oil drain valve and attach the flexible drain tube supplied with the machine. Push in and twist the drain valve counterclockwise. Pull the valve out and drain the oil into a suitable container.
- Close the drain valve by pushing in and twisting clockwise. Replace the yellow cap.
- Refill to the upper limit mark on the dipstick with the recommended oil. Tighten the oil filler cap securely.

ENGINE OIL REFILL CAPACITIES

Without oil filter replacement:

- 1.7qt. (1.6 liter)-Kohler
- 1.5 qt. (1.4 liter)-Subaru Robin

With oil filter replacement:

- 2.0 qt. (1.9 liter)-Kohler
- 1.65 qt. (1.6 liter)-Subaru Robin

Use 4-stroke motor oil that meets or exceeds the requirements for API service classification SG or SH. Always check the API SERVICE label on the oil container to be sure it includes the letters SG or SH.

SAE 10W-30 is recommended for general, all-temperature use, -5° F to 104° F (-20° C to 40° C). For the Subaru Robin engine, it is recommended that SAE 30 oil be used above 82° F (27° C).

See Engine Owner's Manual for more specific information on oil viscosity recommendations.

Wash your hands with soap and water after handling used oil.

Please dispose of used motor oil in a manner that is compatible with the environment. We suggest you take it in a sealed container to your local service station or recycling center for reclamation. Do not throw it in the trash, pour it on the ground or down a drain.

OIL FILTER CHANGE

1. Drain the engine oil.
2. Remove the oil filter, and drain the oil into a suitable container. Discard the used oil filter.
3. Clean the filter mounting base, and coat the gasket of the new oil filter with clean engine oil.

4. Screw on the new oil filter by hand, until the gasket contacts the filter mounting base, then use an oil filter socket tool to tighten the filter an additional 1/2 to 7/8 turn.
5. Refill the crankcase with the specified amount of the recommended oil. Reinstall the oil filler cap.
6. Start the engine and check for oil filter leaks.
7. Stop the engine, and check the oil level. If necessary, add oil to the upper limit mark on the dipstick.

AIR CLEANER SERVICE

A dirty air cleaner will restrict air flow to the carburetor. To prevent carburetor malfunction, service the air cleaner regularly. Service more frequently when operating the engine in extremely dusty areas.

WARNING

- **Never use gasoline or low flash point solvents for cleaning the air cleaner element. A fire or explosion could result.**

CAUTION

- **Never run the engine without the air cleaner. Rapid engine wear will result from contaminants, such as dust and dirt being drawn into the engine.**

AIR PRE-CLEANER SERVICE

1. Loosen the cover retaining knob and remove the cover.
2. Remove the pre-cleaner from the paper element.
3. Wash the pre-cleaner in warm water with detergent. Rinse the pre-cleaner thoroughly until all traces of detergent are eliminated. Squeeze out excess water (do not wring). Allow the pre-cleaner to air dry.
4. Saturate the pre-cleaner with new engine oil. Squeeze out all excess oil.
5. Reinstall the pre-cleaner over the paper element.
6. Reinstall the air cleaner cover. Secure cover with the cover retaining knob.

AIR FILTER PAPER ELEMENT

1. Loosen the cover retaining knob and remove the cover.
2. Remove the pre-cleaner from the paper element.
3. Remove the element cover nut, element cover, and paper element.
4. Do not wash the paper element or use pressurized air, as this will damage the element. Replace a dirty, bent, or damaged element with a new element. Handle new elements carefully; do not use if the sealing surfaces are bent or damaged.
5. When servicing the air cleaner, check the air cleaner base. Make sure it is secured and not bent or damaged. Also check the element cover for damaged or improper fit. Replace all damaged air cleaner components.

NOTE: Before air cleaner is reassembled make sure rubber seal is in position around stud. Inspect, making sure it is not damaged and seals with the element cover.

6. Reinstall the paper element, pre-cleaner, element cover, element cover nut, and air cleaner cover. Secure cover with the cover retaining knob.

SPARK PLUG

To ensure proper engine operation, the spark plug must be properly gapped and free of deposits.

WARNING

NOTE: Before removing spark plug, the muffler becomes very hot during operation and remains hot for a while after stopping the engine. Be careful not to touch the muffler while it is hot.

SPARK PLUG SERVICE

To ensure proper engine operation, the spark plug must be properly gapped and free of deposits.

1. Remove the spark plug cap.
2. Clean any dirt from around the spark plug base.
3. Use a plug wrench to remove the spark plug.
4. Visually inspect the spark plug. Discard them if the insulator is cracked or chipped. Clean the spark plug with a wire brush if it is to be reused.

5. Measure the plug gap with a feeler gauge. Correct as necessary by bending the side electrode.
6. Check that the spark plug washer is in good condition and thread the spark plug in by hand to prevent cross-threading.
7. After the spark plug is seated, tighten with a spark plug wrench to compress the washer. (See proper **spark plug torque** which is specified below).

Spark Plug Gap:

- .030 in. (0.76 mm)-Kohler engine
- .025 in. (0.64 mm)-Robin-Subaru engine

Spark Plug Torque:

- 20 ft. Lb. (27 N-m)-Kohler engine
- 11 ft. Lb. (14 N-m)-Robin-Subaru engine

CAUTION

The spark plug must be securely tightened. An improperly tightened spark plug can become very hot and may cause engine damage. Use only the recommended spark plug or equivalent. A spark plug which has an improper heat range may cause engine damage.

FUEL FILTER

1. Check the fuel filter for water accumulation or sediment.
2. Replace the fuel filter if it is found with excessive water accumulation or sediment.

ENGINE ADJUSTMENT

OVERSPEED IS HAZARDOUS

The maximum allowable high idle speed for this machine is 3750 RPM, no load. Do NOT tamper with governor components or setting or make any other adjustments to increase the maximum speed. Severe personal injury and damage to the machine can result if operated at speeds above maximum.

Adjustments to the engine are to be made only by a Lincoln Service Center or an authorized Field Service Shop.

BATTERY MAINTENANCE

To access the battery, Remove the 2 screws from the rear battery tray using a screwdriver or a 3/8" socket. Slide the battery tray out only far enough to access the battery terminals.

WARNING

GASES FROM BATTERY can explode.

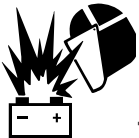

- **Keep sparks, flame and cigarettes away from battery.**

To prevent **EXPLOSION** when:

- **INSTALLING A NEW BATTERY** — disconnect negative cable from old battery first and connect to new battery last.
- **CONNECTING A BATTERY CHARGER** — remove battery from welder by disconnecting negative cable first, then positive cable and battery clamp. When reinstalling, connect negative cable last. Keep well ventilated.
- **USING A BOOSTER** — connect positive lead to battery first then connect negative lead to negative battery lead at engine foot.

BATTERY ACID can burn eyes and skin.



- **Wear gloves and eye protection and be careful when working near battery.**

- **Follow instructions printed on battery.**

CLEANING THE BATTERY

Keep the battery clean by wiping it with a damp cloth when dirty. If the terminals appear corroded, disconnect the battery cables and wash the terminals with an ammonia solution or a solution of 1/4 pound (0.12 kg) of baking soda and 1 quart (0.1 liter) of water. Be sure the battery vent plugs (if equipped) are tight so that none of the solution enters the cells.

After cleaning, flush the outside of the battery, the battery compartment, and surrounding areas with clear water. Coat the battery terminals lightly with petroleum jelly or a non-conductive grease to retard corrosion. Keep the battery clean and dry. Moisture accumulation on the battery can lead to more rapid discharge and early battery failure.

CHECKING THE ELECTROLYTE LEVEL

If battery cells are low, fill them to the neck of the filler hole with distilled water and recharge. If one cell is low, check for leaks.

CHARGING THE BATTERY

When you charge, jump, replace, or otherwise connect battery cables to the battery, be sure the polarity is correct. Improper polarity can damage the charging circuit. The RANGER® 250 positive (+) battery terminal has a red terminal cover.

If you need to charge the battery with an external charger, disconnect the negative cable first, then the positive cable before you attach the charger leads. After the battery is charged, reconnect the positive battery cable first and the negative cable last. Failure to do so can result in damage to the internal charger components.

Follow the instructions of the battery charger manufacturer for proper charger settings and charging time.

SERVICING OPTIONAL SPARK ARRESTER

Clean every 100 hours.

WARNING

MUFFLER MAY BE HOT

- **ALLOW ENGINE TO COOL BEFORE INSTALLING THE SPARK ARRESTER!**
- **DO NOT OPERATE ENGINE WHILE INSTALLING THE SPARK ARRESTER!**

WELDER / GENERATOR MAINTENANCE

STORAGE: Store the RANGER® 250 in clean, dry protected areas.

CLEANING: Blow out the generator and controls periodically with low pressure air. Do this at least once a week in particularly dirty areas.

BRUSH REMOVAL AND REPLACEMENT: It's normal for the brushes and slip rings to wear and darken slightly. Inspect the brushes when a generator overhaul is necessary.

CAUTION

- Do not attempt to polish slip rings while the engine is running.

WARNING

- Service and Repair should only be performed by Lincoln Electric Factory Trained Personnel. Unauthorized repairs performed on this equipment may result in danger to the technician and machine operator and will invalidate your factory warranty. For your safety and to avoid Electrical Shock, please observe all safety notes and precautions.
-

HOW TO USE TROUBLESHOOTING GUIDE

WARNING

Service and Repair should only be performed by Lincoln Electric Factory Trained Personnel. Unauthorized repairs performed on this equipment may result in danger to the technician and machine operator and will invalidate your factory warranty. For your safety and to avoid Electrical Shock, please observe all safety notes and precautions detailed throughout this manual.

This Troubleshooting Guide is provided to help you locate and repair possible machine malfunctions. Simply follow the three-step procedure listed below.

Step 1. LOCATE PROBLEM (SYMPTOM).

Look under the column labeled "PROBLEM (SYMPTOMS)". This column describes possible symptoms that the machine may exhibit. Find the listing that best describes the symptom that the machine is exhibiting.

Step 2. POSSIBLE CAUSE.

The second column labeled "POSSIBLE CAUSE" lists the obvious external possibilities that may contribute to the machine symptom.

Step 3. RECOMMENDED COURSE OF ACTION

This column provides a course of action for the Possible Cause, generally it states to contact your local Lincoln Authorized Field Service Facility.

If you do not understand or are unable to perform the Recommended Course of Action safely, contact your local Lincoln Authorized Field Service Facility.

CAUTION

If for any reason you do not understand the test procedures or are unable to perform the tests/repairs safely, contact your **Local Lincoln Authorized Field Service Facility** for technical troubleshooting assistance before you proceed.

Observe all Safety Guidelines detailed throughout this manual

PROBLEMS (SYMPTOMS)	POSSIBLE CAUSE	RECOMMENDED COURSE OF ACTION
Major Physical or Electrical Damage is Evident.	1. If all recommended possible areas of misadjustment have been checked and the problem persists, Contact your local Lincoln Authorized Field Service Facility.	If all recommended possible areas of misadjustment have been checked and the problem persists, Contact your local Lincoln Authorized Field Service Facility.
Engine will not "crank".	<ol style="list-style-type: none"> 1. Battery is low. 2. Loose battery cable connections. 3. Faulty engine starter motor. 4. "Battery Circuit" circuit breaker is tripped. 	
Engine will "crank" but not start.	<ol style="list-style-type: none"> 1. Out of fuel. 2. Faulty fuel solenoid or faulty PC board or ignition system. 3. Fuel pump not working. 	
Engine shuts down shortly after starting.	<ol style="list-style-type: none"> 1. Low oil level. 2. Faulty oil pressure switch or other engine component. 	
Battery does not stay charged.	<ol style="list-style-type: none"> 1. Faulty battery. 2. Loose connections at battery or alternator. 3. Faulty engine alternator or charger module. 	

 **CAUTION**

If for any reason you do not understand the test procedures or are unable to perform the tests/repairs safely, contact your **Local Lincoln Authorized Field Service Facility** for technical troubleshooting assistance before you proceed.

RANGER® 250



Observe all Safety Guidelines detailed throughout this manual

PROBLEMS (SYMPTOMS)	POSSIBLE CAUSE	RECOMMENDED COURSE OF ACTION
Engine will not idle down to low speed.	<ol style="list-style-type: none"> 1. Idler switch in High idle position. 2. External load on welder or auxiliary power. 3. Faulty PC board or idler solenoid. 	<p>If all recommended possible areas of misadjustment have been checked and the problem persists, Contact your local Lincoln Authorized Field Service Facility.</p>
Engine will not go to high idle when attempting to weld.	<ol style="list-style-type: none"> 1. Poor work lead connection to work. 2. "Contactor" switch is in wrong position. 3. Faulty PC board. Low idle speed set to low. 	
Engine will not go to high idle when using auxiliary power.	<ol style="list-style-type: none"> 1. Auxiliary power load is less than 100 watts. 2. Faulty PC board. 	
Engine does not develop full power.	<ol style="list-style-type: none"> 1. Fuel filter clogged. 2. Fuel lift pump not working. 3. Air filter clogged. 4. Fouled spark plugs. 5. Valves out of adjustment. 	

 **CAUTION**

If for any reason you do not understand the test procedures or are unable to perform the tests/repairs safely, contact your **Local Lincoln Authorized Field Service Facility** for technical troubleshooting assistance before you proceed.

RANGER® 250



Observe all Safety Guidelines detailed throughout this manual

PROBLEMS (SYMPTOMS)	POSSIBLE CAUSE	RECOMMENDED COURSE OF ACTION
No welding power output.	<ol style="list-style-type: none"> 1. Poor work lead connection to work. 2. "Weld Terminals" switch in wrong position. 3. Faulty PC board or welder alternator. 	<p>If all recommended possible areas of misadjustment have been checked and the problem persists, Contact your local Lincoln Authorized Field Service Facility.</p>
Welder has output but no control.	<ol style="list-style-type: none"> 1. Poor remote / control cable connection to 6 pin or 14 pin Amphenol connector. 2. Faulty remote cable or faulty wire feeder or wire feeder cable. 3. Faulty control potentiometer or PC board. 	
Wire feeder does not work when control cable is connected to 14 pin Connector.	<ol style="list-style-type: none"> 1. Wire Feeder Power circuit breaker open. 2. Faulty control cable. 3. Faulty wire feeder. 	
No auxiliary power.	<ol style="list-style-type: none"> 1. Open circuit breakers. 2. Faulty connections to auxiliary receptacles. 3. GFCI tripped (if installed). 4. Brushes worn or not on contact with slip rings. 5. Rotor winding not receiving flashing current from PC board. 6. Rotor winding open. 	

 **CAUTION**

If for any reason you do not understand the test procedures or are unable to perform the tests/repairs safely, contact your **Local Lincoln Authorized Field Service Facility** for technical troubleshooting assistance before you proceed.

RANGER® 250



Observe all Safety Guidelines detailed throughout this manual

PROBLEMS (SYMPTOMS)	POSSIBLE CAUSE	RECOMMENDED COURSE OF ACTION
<p>The welding arc is "cold." The welding arc is not stable or is not satisfactory. the engine runs normally. The auxiliary power is normal.</p>	<ol style="list-style-type: none"> 1. Make sure the MODE selector switch is in the correct position for the process being used. (For example, CV-WIRE, PIPE, CC-STICK.) 2. Make sure the electrode (wire, gas, voltage, current etc.) is correct for the process being used. 3. Check for loose or faulty connections at the weld output terminals and welding cable connections. 4. The welding cables may be too long or coiled, causing an excessive voltage drop. 	<p>If all recommended possible areas of misadjustment have been checked and the problem persists, Contact your local Lincoln Authorized Field Service Facility.</p>

 **CAUTION**

If for any reason you do not understand the test procedures or are unable to perform the tests/repairs safely, contact your **Local Lincoln Authorized Field Service Facility** for technical troubleshooting assistance before you proceed.

RANGER® 250



RANGER 250G - WIRING DIAGRAM

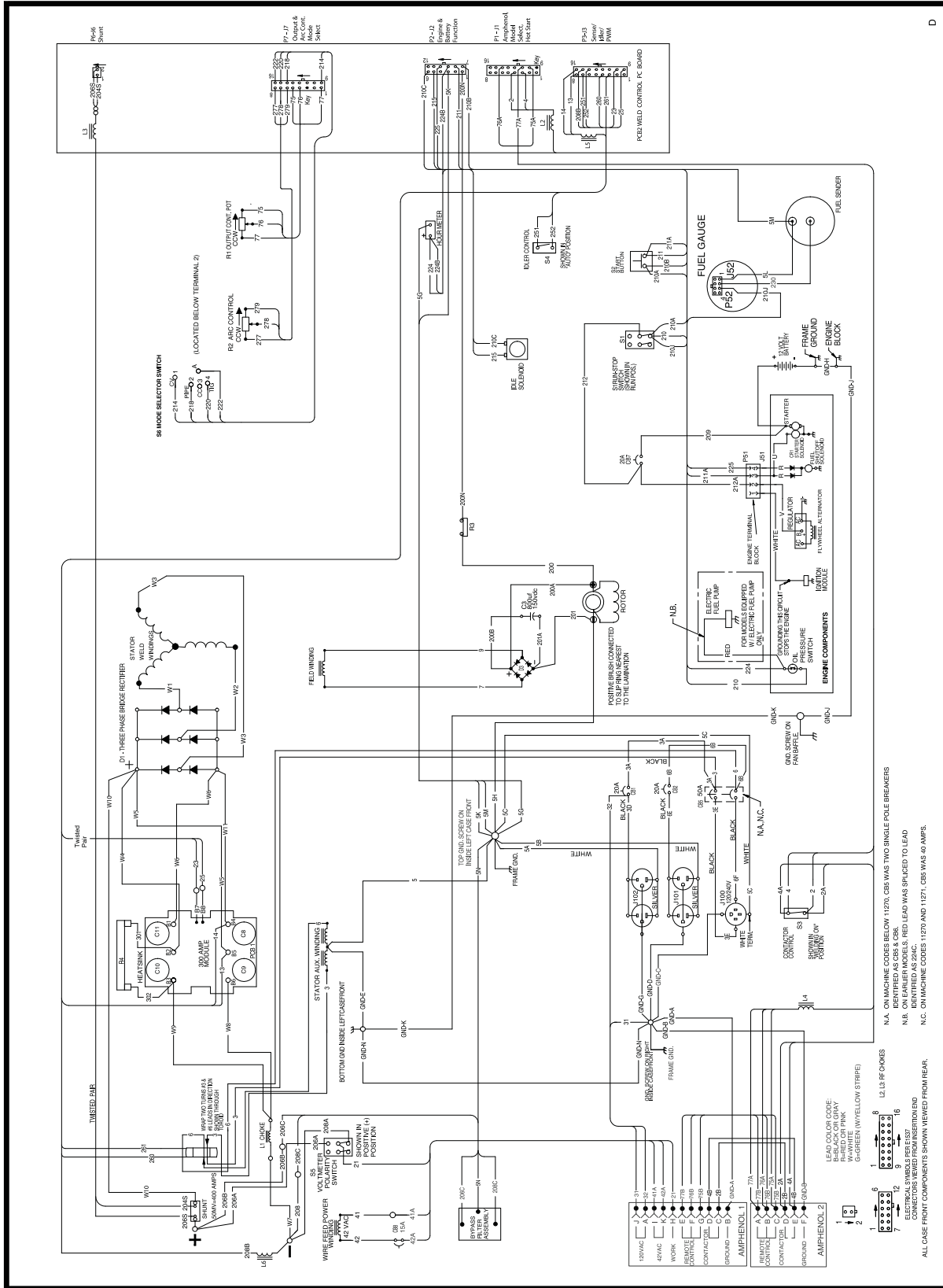

G4568

NOTE: This diagram is for reference only. It may not be accurate for all machines covered by this manual. The specific diagram for a particular code is pasted inside the machine on one of the enclosure panels. If the diagram is illegible, write to the Service Department for a replacement. Give the equipment code number.

ENGINE WELDERS /LN-25 ACROSS THE ARC CONNECTION DIAGRAM WITH OPTIONAL K857 REMOTE CONTROL

	WARNING	
<ul style="list-style-type: none"> • Do not operate with panels open. • Disconnect NEGATIVE (-) Battery lead before servicing. • Do not touch electrically live parts. 		<ul style="list-style-type: none"> • Keep guards in place. • Keep away from moving parts. • Only qualified personnel should install, use or service this equipment.

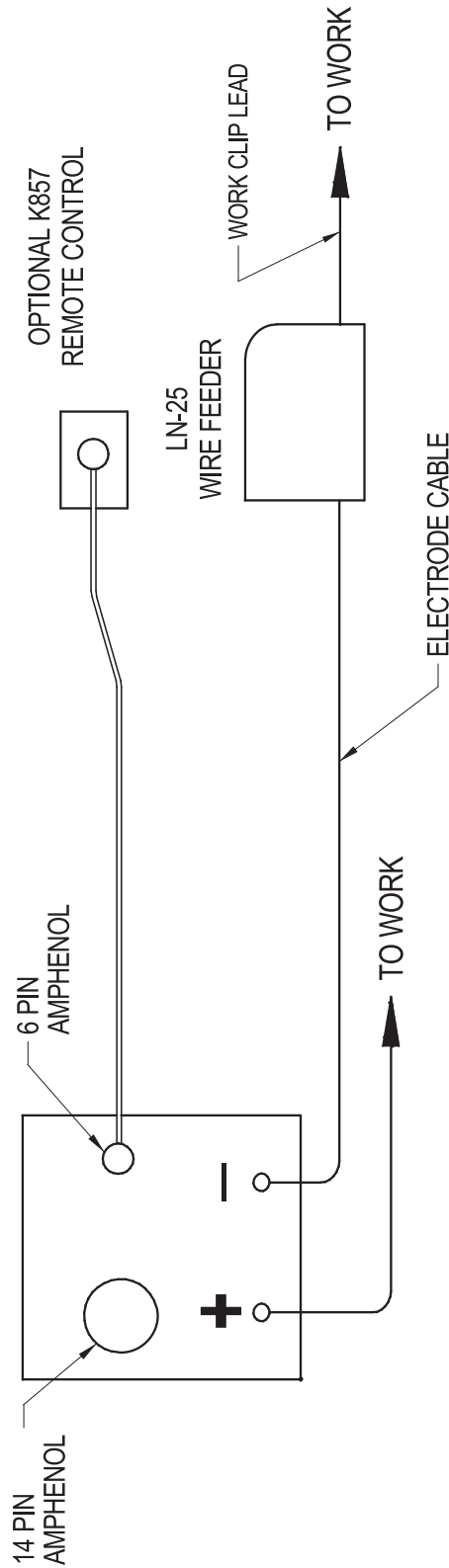

- N.A. WELDING CABLES MUST BE OF PROPER CAPACITY FOR THE CURRENT AND DUTY CYCLE OF IMMEDIATE AND FUTURE APPLICATIONS. SEE OPERATING MANUAL.
- N.B. CONNECT WELDING CABLES TO OUTPUT STUDS FOR DESIRED POLARITY. POSITION THE WIRE FEEDER VOLT/METER SWITCH TO MATCH THE POLARITY OF THE ELECTRODE CABLE.
- N.C. PLACE THE MODE SWITCH IN THE "CV-WIRE" POSITION.
- N.D. PLACE THE WELDING TERMINALS SWITCH IN THE "WELD TERMINALS ON" POSITION.
- N.E. PLACE IDLER SWITCH IN "AUTO" OR "HIGH" IDLE POSITION AS DESIRED.

10-27-2000

S24787-1

ENGINE WELDERS /LN-25 ACROSS THE ARC CONNECTION DIAGRAM WITH OPTIONAL K444-1 REMOTE CONTROL

	WARNING	
<ul style="list-style-type: none"> Do not operate with panels open. Disconnect NEGATIVE (-) Battery lead before servicing. Do not touch electrically live parts. 		<ul style="list-style-type: none"> Keep guards in place. Keep away from moving parts. Only qualified personnel should install, use or service this equipment.

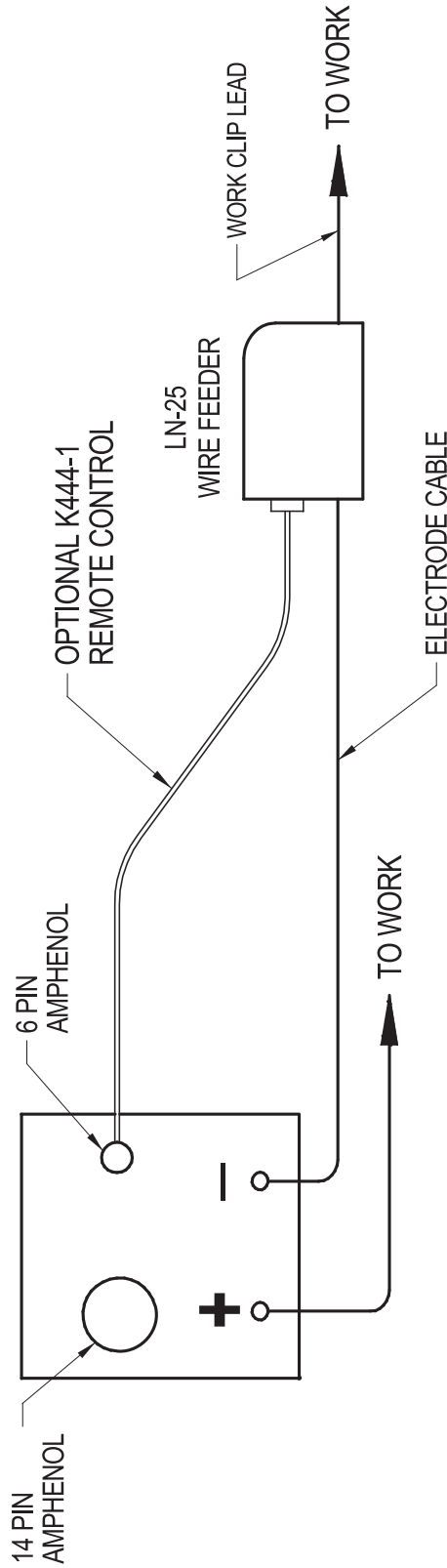

- N.A. WELDING CABLES MUST BE OF PROPER CAPACITY FOR THE CURRENT AND DUTY CYCLE OF IMMEDIATE AND FUTURE APPLICATIONS. SEE OPERATING MANUAL.
- N.B. CONNECT WELDING CABLES TO OUTPUT STUDS FOR DESIRED POLARITY. POSITION THE WIRE FEEDER VOLT METER SWITCH TO MATCH THE POLARITY OF THE ELECTRODE CABLE.
- N.C. PLACE THE MODE SWITCH IN THE "CV-WIRE" POSITION.
- N.D. PLACE THE WELDING TERMINALS SWITCH IN THE "WELD TERMINALS ON" POSITION.
- N.E. PLACE IDLER SWITCH IN "AUTO" OR "HIGH" IDLE POSITION AS DESIRED.

10-27-2000

S24787-2

ENGINE WELDERS /LN-25 WITH K624-1 42 VOLT REMOTE OUTPUT CONTROL MODULE CONNECTION DIAGRAM

	<h2>WARNING</h2>	
<ul style="list-style-type: none"> ● Do not operate with panels open. ● Disconnect NEGATIVE (-) Battery lead before servicing. ● Do not touch electrically live parts. 		<ul style="list-style-type: none"> ● Keep guards in place. ● Keep away from moving parts. ● Only qualified personnel should install, use or service this equipment.

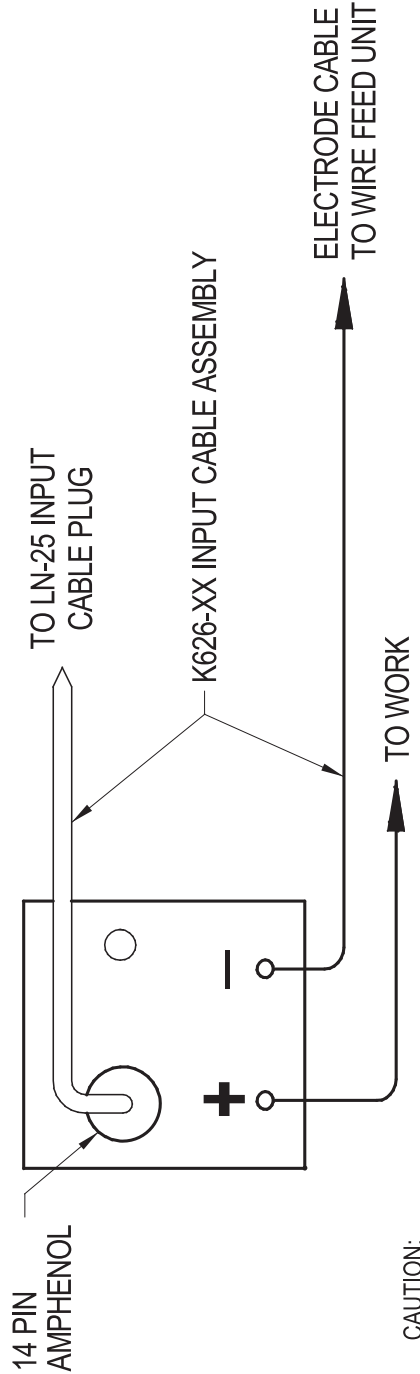

CAUTION:

ANY INCREASE OF THE HIGH IDLE ENGINE RPM BY CHANGING THE GOVERNOR SETTING OR OVERRIDING THE THROTTLE LINKAGE WILL CAUSE AN INCREASE IN THE AC WIRE FEEDER VOLTAGE, WHICH CAN DAMAGE THE CONTROL CIRCUIT. THE ENGINE GOVERNOR SETTING IS PRE-SET AT THE FACTORY – DO NOT ADJUST ABOVE RPM SPECIFICATIONS LISTED IN THE ENGINE WELDER OPERATING MANUAL.

- N.A. PLACE THE MODE SWITCH IN THE "CV-WIRE" POSITION. PLACE WELDER TERMINALS SWITCH TO "REMOTELY CONTROLLED" POSITION.
- N.B. CONNECT WELDING CABLES TO OUTPUT STUDS FOR DESIRED POLARITY. POSITION THE WIRE FEEDER VOLTMETER SWITCH TO MATCH THE POLARITY OF THE ELECTRODE CABLE.
- N.C. WELDING CABLES MUST BE OF PROPER CAPACITY FOR THE CURRENT AND DUTY CYCLE OF IMMEDIATE AND FUTURE APPLICATIONS. SEE OPERATING MANUAL.
- N.D. PLACE IDLER SWITCH IN "AUTO" OR "HIGH" IDLE POSITION AS DESIRED.

10-27-2000

S24787-3

ENGINE WELDERS /LN-7 CONNECTION DIAGRAM

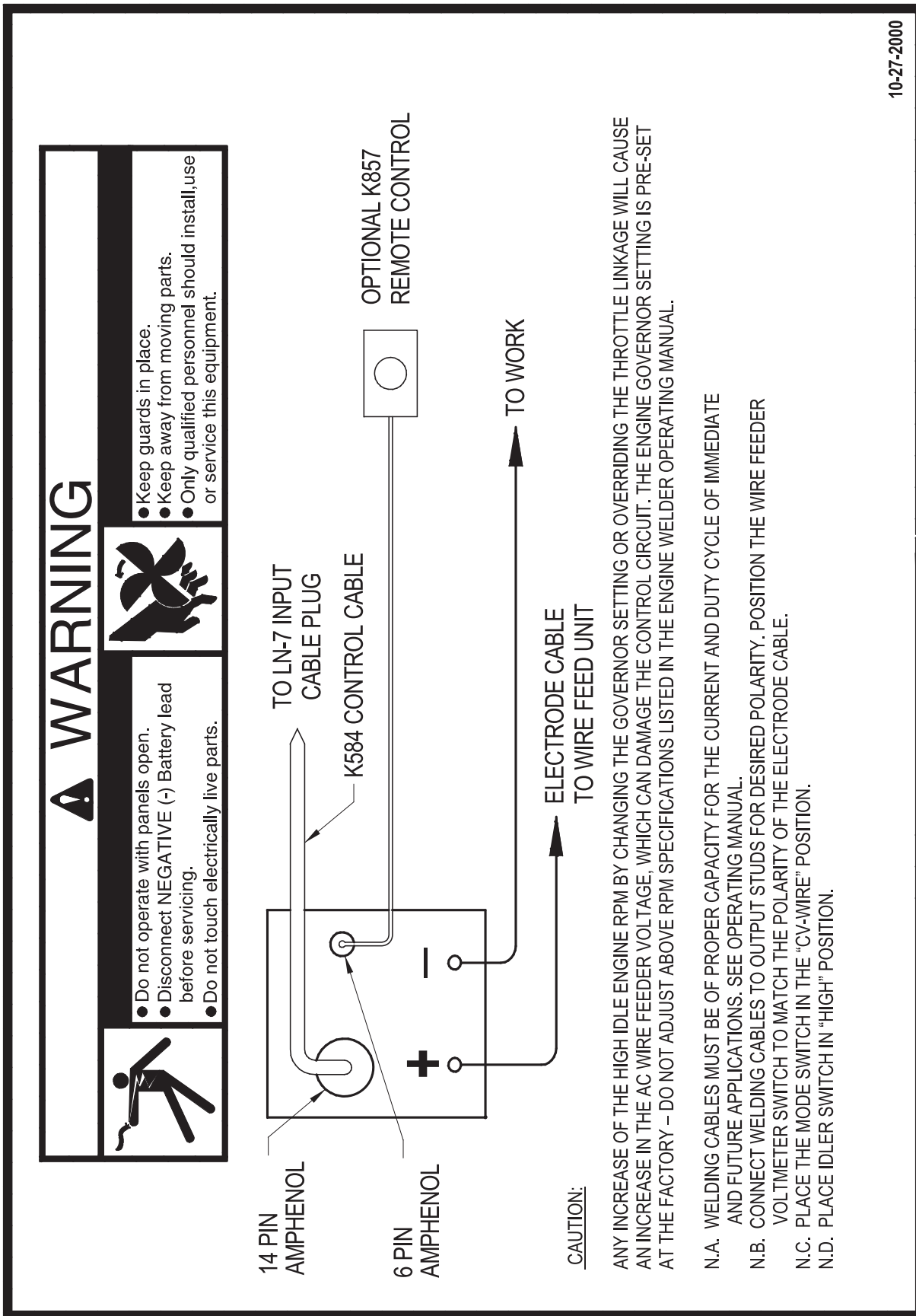

ENGINE WELDERS /LN-742 CONNECTION DIAGRAM

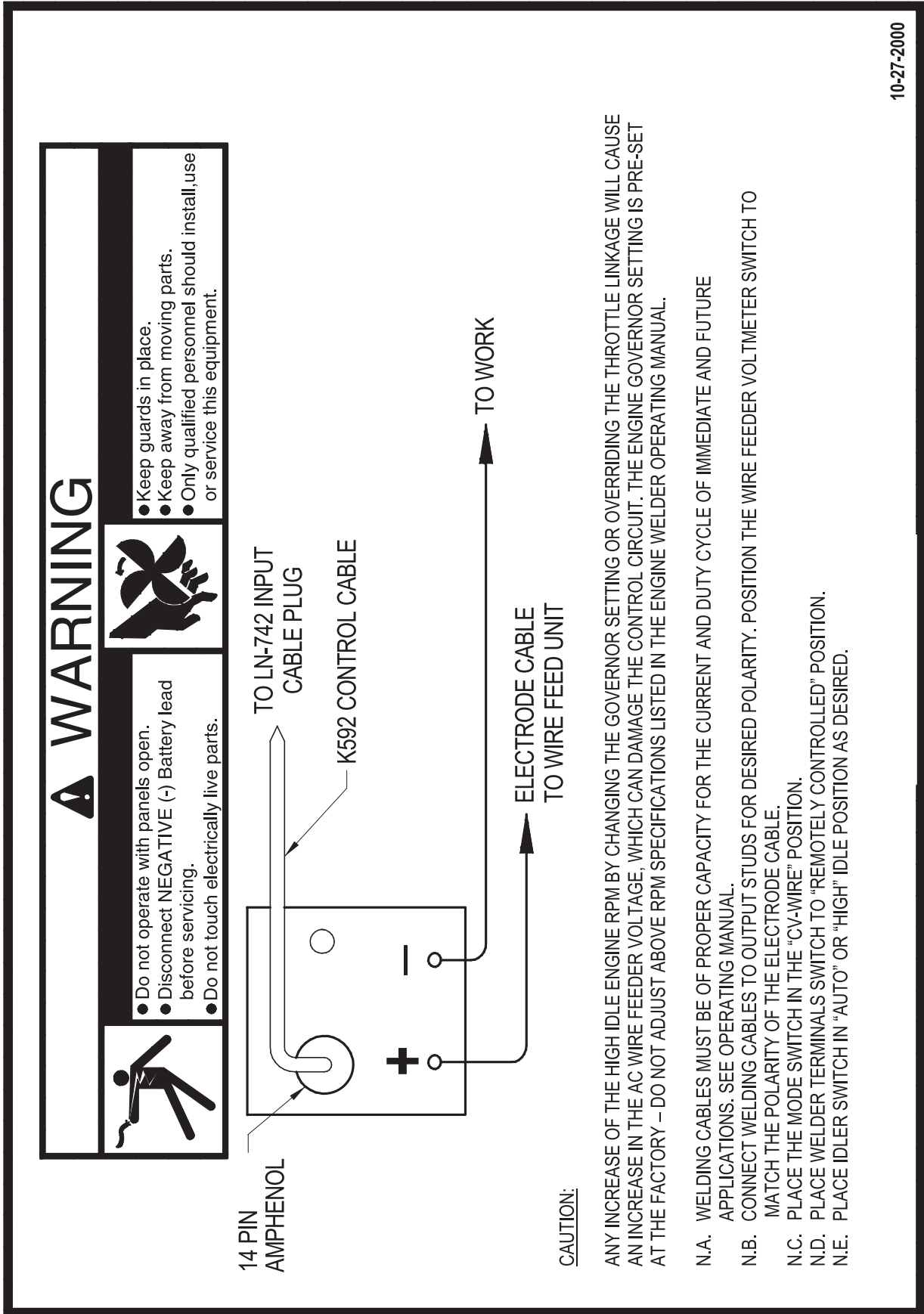

RANGER® 250

LINCOLN
ELECTRIC

ENGINE WELDERS /LN-8 CONNECTION DIAGRAM

	<h2>WARNING</h2>	
<ul style="list-style-type: none"> • Do not operate with panels open. • Disconnect NEGATIVE (-) Battery lead before servicing. • Do not touch electrically live parts. 		<ul style="list-style-type: none"> • Keep guards in place. • Keep away from moving parts. • Only qualified personnel should install, use or service this equipment.

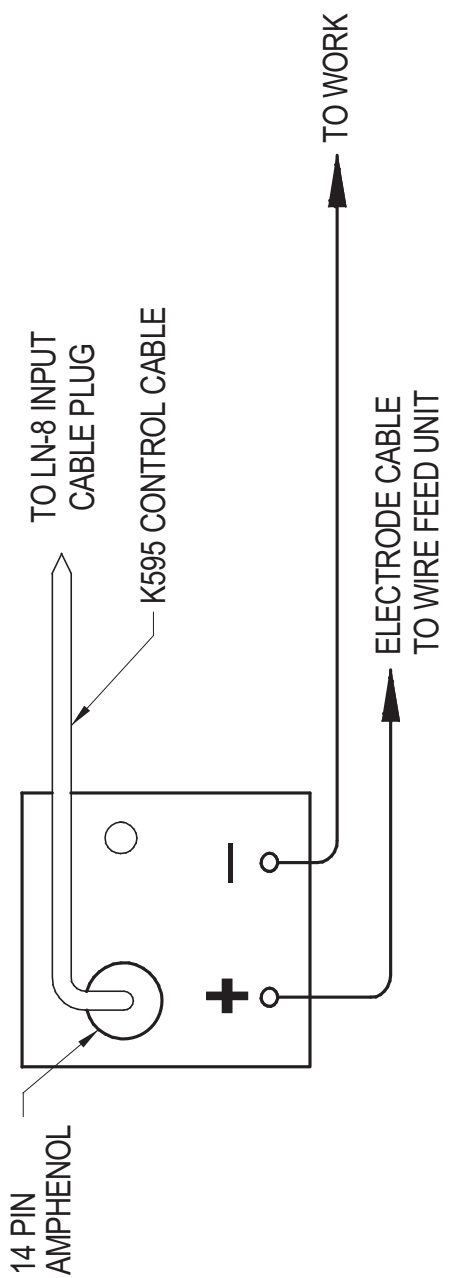

CAUTION:

ANY INCREASE OF THE HIGH IDLE ENGINE RPM BY CHANGING THE GOVERNOR SETTING OR OVERRIDING THE THROTTLE LINKAGE WILL CAUSE AN INCREASE IN THE AC WIRE FEEDER VOLTAGE, WHICH CAN DAMAGE THE CONTROL CIRCUIT. THE ENGINE GOVERNOR SETTING IS PRE-SET AT THE FACTORY - DO NOT ADJUST ABOVE RPM SPECIFICATIONS LISTED IN THE ENGINE WELDER OPERATING MANUAL.

N.A. WELDING CABLES MUST BE OF PROPER CAPACITY FOR THE CURRENT AND DUTY CYCLE OF IMMEDIATE AND FUTURE APPLICATIONS. SEE OPERATING MANUAL.

N.B. CONNECT WELDING CABLES TO OUTPUT STUDS FOR DESIRED POLARITY. POSITION THE WIRE FEEDER VOLT/METER SWITCH TO MATCH THE POLARITY OF THE ELECTRODE CABLE.

N.C. PLACE IDLER SWITCH IN "HIGH" POSITION.

4-14-2000

S24787-6

ENGINE WELDERS TO K867 CONTROL CABLE ADAPTER CONNECTION DIAGRAM

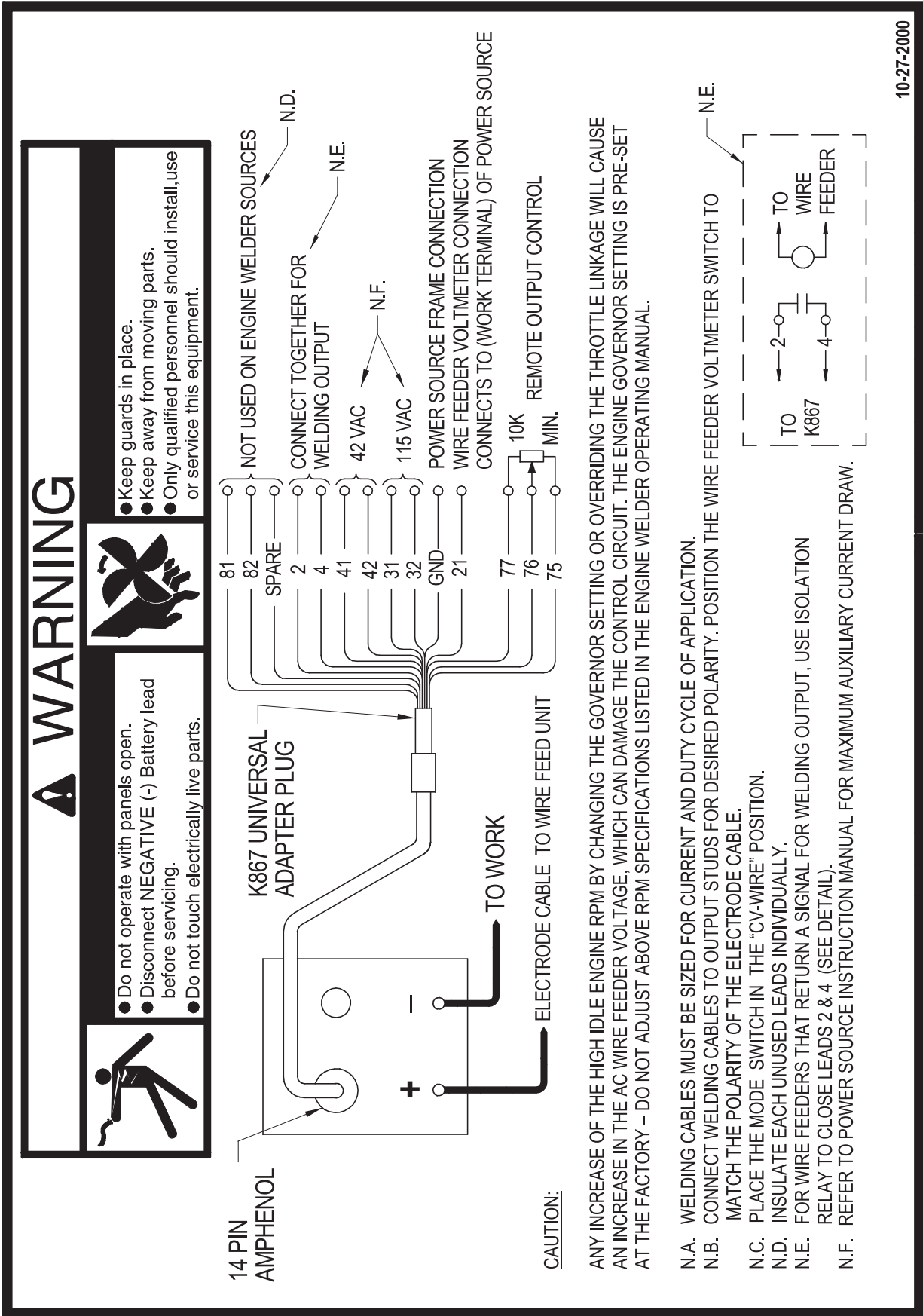

ENGINE WELDERS / K691-10 / K488 / K487 SPOOL GUN CONNECTION DIAGRAM

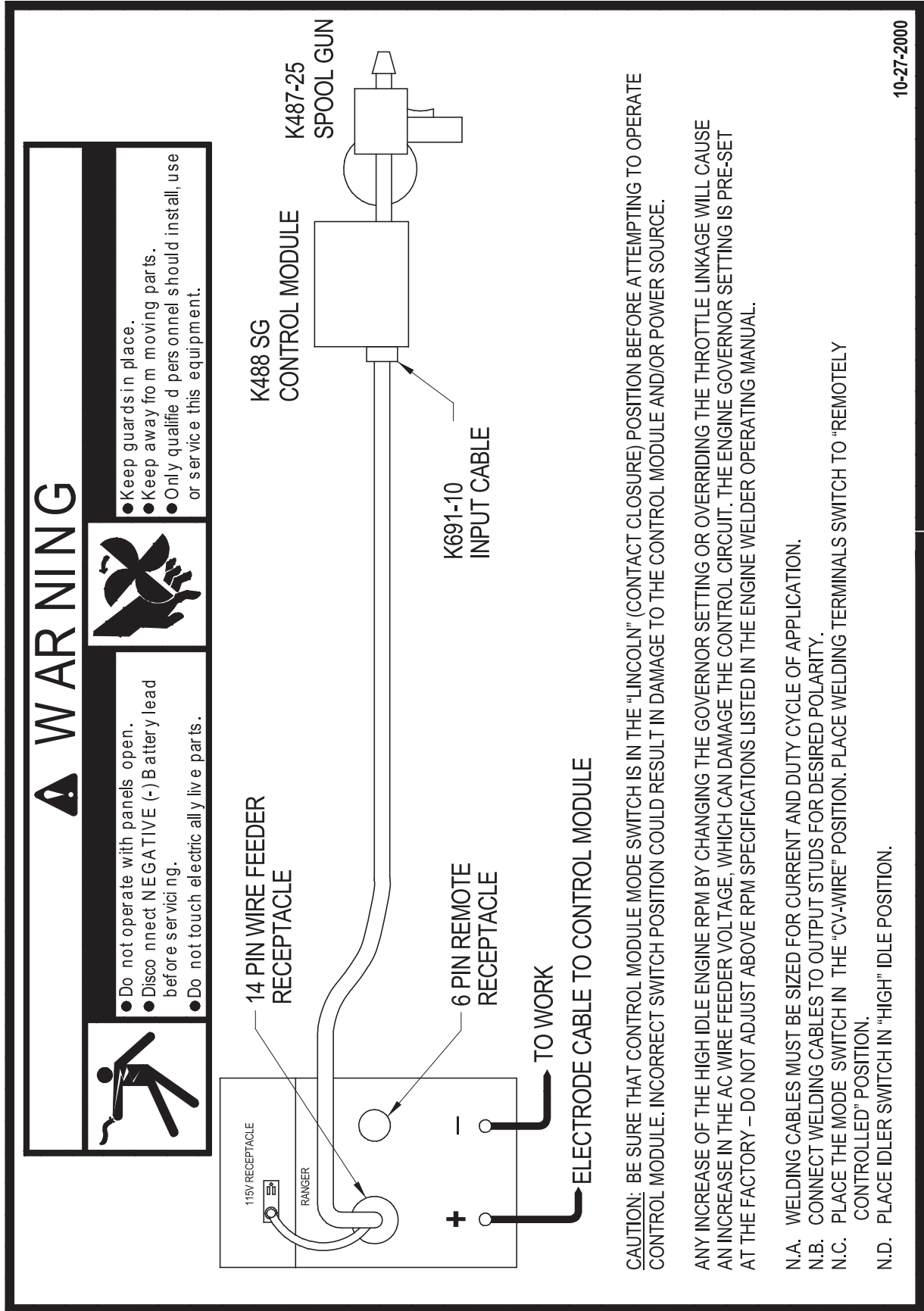

ENGINE WELDERS / K930 TIG MODULE / CONNECTION DIAGRAM

WARNING



- Do not operate with panels open.
- Disconnect NEGATIVE (-) Battery lead before servicing.
- Do not touch electrically live parts.



- Keep guards in place.
- Keep away from moving parts.
- Only qualified personnel should install, use or service this equipment.

REGULATOR FLOWMETER

ARGON GAS CYLINDER

14 PIN AMPHENOL

TO GAS INPUT FITTING

K936-1 CONTROL CABLE

ELECTRODE

TO WORK

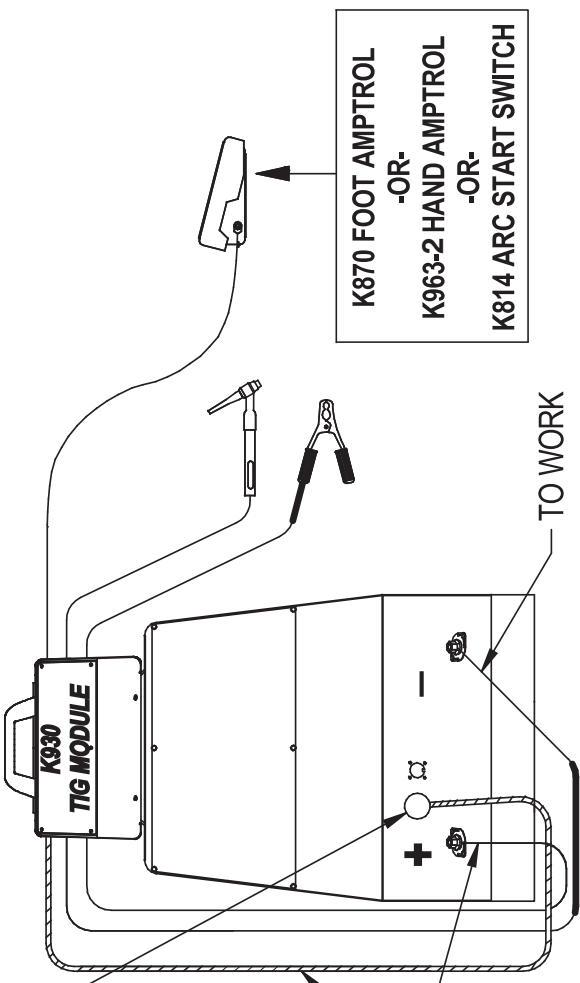

CAUTION:

ANY INCREASE OF THE HIGH IDLE ENGINE RPM BY CHANGING THE GOVERNOR SETTING OR OVERRIDING THE THROTTLE LINKAGE WILL CAUSE AN INCREASE IN THE AC WIRE FEEDER VOLTAGE, WHICH CAN DAMAGE THE CONTROL CIRCUIT. THE ENGINE GOVERNOR SETTING IS PRE-SET AT THE FACTORY – DO NOT ADJUST ABOVE RPM SPECIFICATIONS LISTED IN THE ENGINE WELDER OPERATING MANUAL.

N.A. WELDING CABLES MUST BE OF PROPER CAPACITY FOR THE CURRENT AND DUTY CYCLE OF IMMEDIATE AND FUTURE APPLICATIONS. SEE OPERATING MANUAL.

N.B. CONNECT WELDING CABLES TO OUTPUT STUDS FOR DESIRED POLARITY.

N.C. PLACE THE MODE SWITCH IN THE "TIG" POSITION.

N.D. PLACE OUTPUT CONTROL SWITCH IN "REMOTE CONTROL" POSITION.

N.E. PLACE IDLER SWITCH IN "AUTO" OR "HIGH" IDLE POSITION AS DESIRED.

9/03

S24787-9

ENGINE WELDERS / K1587-1 COBRAMATIC CONNECTION DIAGRAM

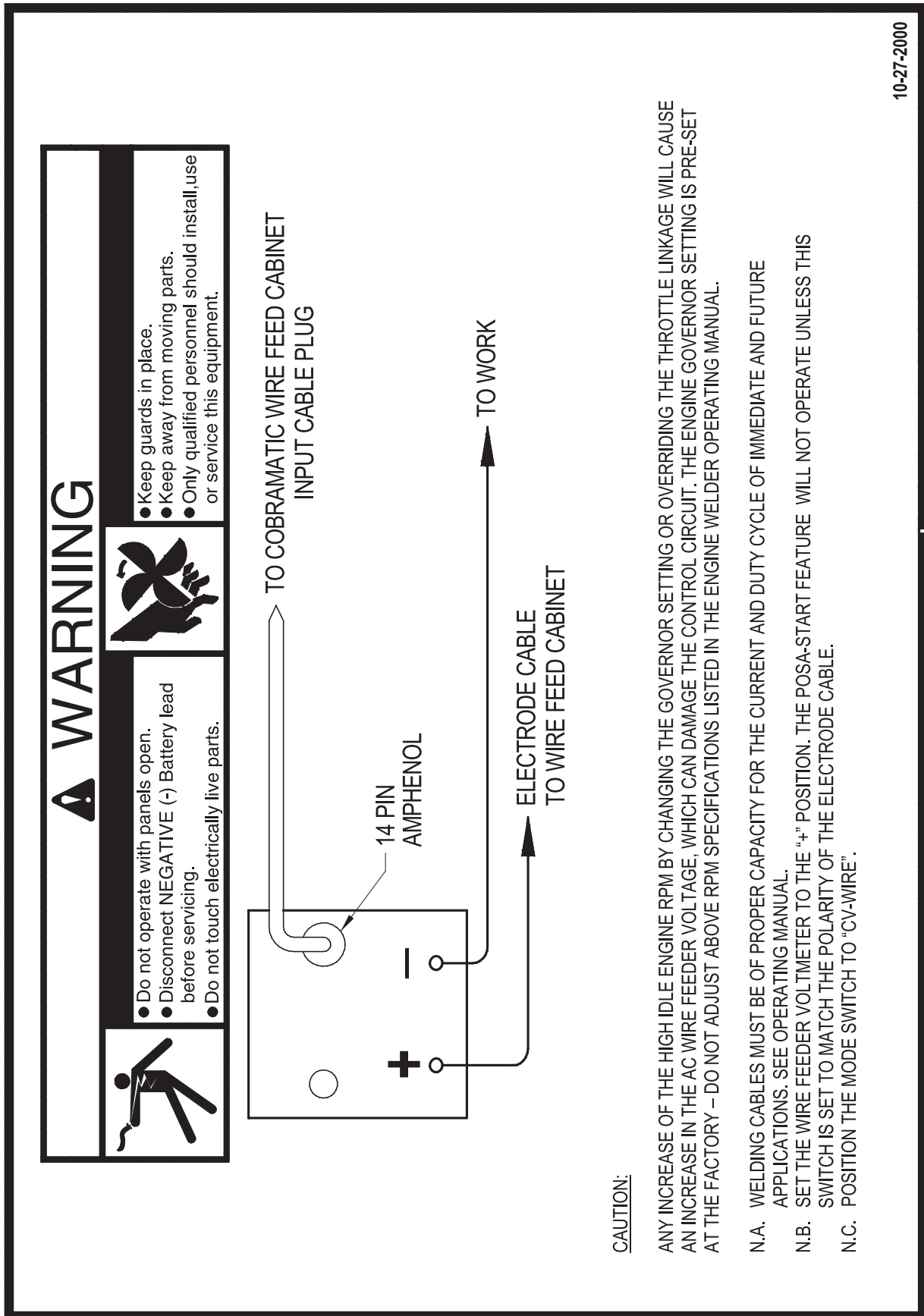

RANGER® 250

LINCOLN
ELECTRIC

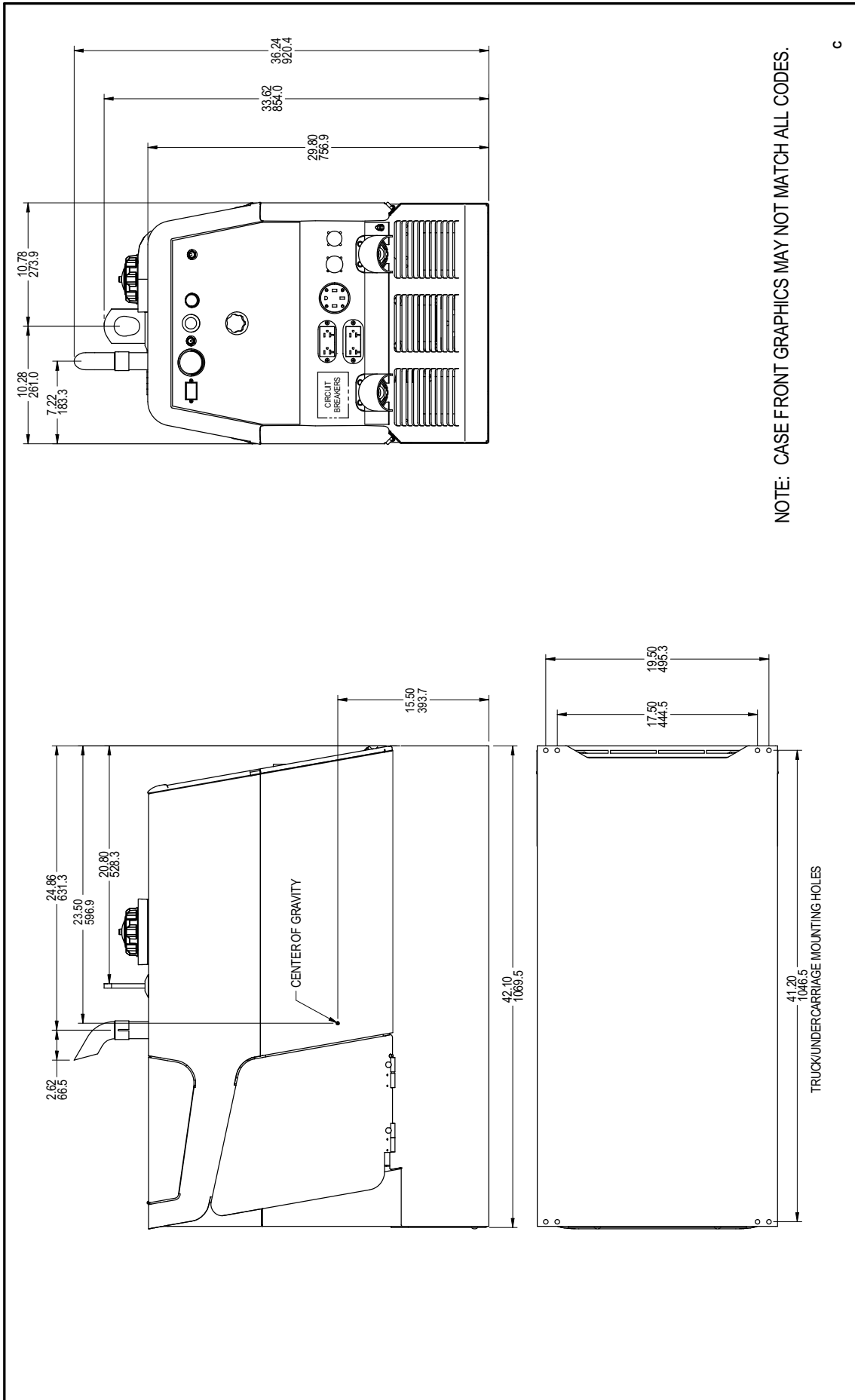

NOTE: CASE FRONT GRAPHICS MAY NOT MATCH ALL CODES.

c

M20333

RANGER® 250



WARNING	<ul style="list-style-type: none"> Do not touch electrically live parts or electrode with skin or wet clothing. Insulate yourself from work and ground. 	<ul style="list-style-type: none"> Keep flammable materials away. 	<ul style="list-style-type: none"> Wear eye, ear and body protection.
Spanish AVISO DE PRECAUCION	<ul style="list-style-type: none"> No toque las partes o los electrodos bajo carga con la piel o ropa mojada. Aislese del trabajo y de la tierra. 	<ul style="list-style-type: none"> Mantenga el material combustible fuera del área de trabajo. 	<ul style="list-style-type: none"> Protéjase los ojos, los oídos y el cuerpo.
French ATTENTION	<ul style="list-style-type: none"> Ne laissez ni la peau ni des vêtements mouillés entrer en contact avec des pièces sous tension. Isolez-vous du travail et de la terre. 	<ul style="list-style-type: none"> Gardez à l'écart de tout matériel inflammable. 	<ul style="list-style-type: none"> Protégez vos yeux, vos oreilles et votre corps.
German WARNUNG	<ul style="list-style-type: none"> Berühren Sie keine stromführenden Teile oder Elektroden mit Ihrem Körper oder feuchter Kleidung! Isolieren Sie sich von den Elektroden und dem Erdboden! 	<ul style="list-style-type: none"> Entfernen Sie brennbares Material! 	<ul style="list-style-type: none"> Tragen Sie Augen-, Ohren- und Körperschutz!
Portuguese ATENÇÃO	<ul style="list-style-type: none"> Não toque partes elétricas e electrodos com a pele ou roupa molhada. Isole-se da peça e terra. 	<ul style="list-style-type: none"> Mantenha inflamáveis bem guardados. 	<ul style="list-style-type: none"> Use proteção para a vista, ouvido e corpo.
Japanese 注意事項	<ul style="list-style-type: none"> 通電中の電気部品、又は溶材にヒフやぬれた布で触れないこと。 施工物やアースから身体が絶縁されている様にして下さい。 	<ul style="list-style-type: none"> 燃えやすいものの側での溶接作業は絶対にしてはなりません。 	<ul style="list-style-type: none"> 目、耳及び身体に保護具をして下さい。
Chinese 警告	<ul style="list-style-type: none"> 皮肤或湿衣物切勿接触带电部件及焊条。 使你自已与地面和工作件绝缘。 	<ul style="list-style-type: none"> 把一切易燃物品移离工作场所。 	<ul style="list-style-type: none"> 佩戴眼、耳及身体劳动保护用具。
Korean 위험	<ul style="list-style-type: none"> 전도체나 용접봉을 젖은 형갑 또는 피부로 절대 접촉치 마십시오. 모재와 접지를 접촉치 마십시오. 	<ul style="list-style-type: none"> 인화성 물질을 접근시키지 마십시오. 	<ul style="list-style-type: none"> 눈, 귀와 몸에 보호장구를 착용하십시오.
Arabic تحذير	<ul style="list-style-type: none"> لا تلمس الاجزاء التي يسري فيها التيار الكهربائي أو الألكترود بجسد الجسم أو بالملابس المبللة بالماء. ضع عازلا على جسمك خلال العمل. 	<ul style="list-style-type: none"> ضع المواد القابلة للاشتعال في مكان بعيد. 	<ul style="list-style-type: none"> ضع أدوات وملابس واقية على عينيك وأذنيك وجسمك.

READ AND UNDERSTAND THE MANUFACTURER'S INSTRUCTION FOR THIS EQUIPMENT AND THE CONSUMABLES TO BE USED AND FOLLOW YOUR EMPLOYER'S SAFETY PRACTICES.

SE RECOMIENDA LEER Y ENTENDER LAS INSTRUCCIONES DEL FABRICANTE PARA EL USO DE ESTE EQUIPO Y LOS CONSUMIBLES QUE VA A UTILIZAR, SIGA LAS MEDIDAS DE SEGURIDAD DE SU SUPERVISOR.

LISEZ ET COMPRENEZ LES INSTRUCTIONS DU FABRICANT EN CE QUI REGARDE CET EQUIPMENT ET LES PRODUITS A ETRE EMPLOYES ET SUIVEZ LES PROCEDURES DE SECURITE DE VOTRE EMPLOYEUR.

LESEN SIE UND BEFOLGEN SIE DIE BETRIEBSANLEITUNG DER ANLAGE UND DEN ELEKTRODENEINSATZ DES HERSTELLERS. DIE UNFALLVERHÜTUNGSVORSCHRIFTEN DES ARBEITGEBERS SIND EBENFALLS ZU BEACHTEN.

			
<ul style="list-style-type: none"> ● Keep your head out of fumes. ● Use ventilation or exhaust to remove fumes from breathing zone. 	<ul style="list-style-type: none"> ● Turn power off before servicing. 	<ul style="list-style-type: none"> ● Do not operate with panel open or guards off. 	WARNING
<ul style="list-style-type: none"> ● Los humos fuera de la zona de respiración. ● Mantenga la cabeza fuera de los humos. Utilice ventilación o aspiración para gases. 	<ul style="list-style-type: none"> ● Desconectar el cable de alimentación de poder de la máquina antes de iniciar cualquier servicio. 	<ul style="list-style-type: none"> ● No operar con panel abierto o guardas quitadas. 	Spanish AVISO DE PRECAUCION
<ul style="list-style-type: none"> ● Gardez la tête à l'écart des fumées. ● Utilisez un ventilateur ou un aspirateur pour ôter les fumées des zones de travail. 	<ul style="list-style-type: none"> ● Débranchez le courant avant l'entretien. 	<ul style="list-style-type: none"> ● N'opérez pas avec les panneaux ouverts ou avec les dispositifs de protection enlevés. 	French ATTENTION
<ul style="list-style-type: none"> ● Vermeiden Sie das Einatmen von Schweißrauch! ● Sorgen Sie für gute Be- und Entlüftung des Arbeitsplatzes! 	<ul style="list-style-type: none"> ● Strom vor Wartungsarbeiten abschalten! (Netzstrom völlig öffnen; Maschine anhalten!) 	<ul style="list-style-type: none"> ● Anlage nie ohne Schutzgehäuse oder Innenschutzverkleidung in Betrieb setzen! 	German WARNUNG
<ul style="list-style-type: none"> ● Mantenha seu rosto da fumaça. ● Use ventilação e exaustão para remover fumo da zona respiratória. 	<ul style="list-style-type: none"> ● Não opere com as tampas removidas. ● Desligue a corrente antes de fazer serviço. ● Não toque as partes elétricas nuas. 	<ul style="list-style-type: none"> ● Mantenha-se afastado das partes moventes. ● Não opere com os painéis abertos ou guardas removidas. 	Portuguese ATENÇÃO
<ul style="list-style-type: none"> ● ヒュームから頭を離すようにして下さい。 ● 換気や排煙に十分留意して下さい。 	<ul style="list-style-type: none"> ● メンテナンス・サービスに取りかかる際には、まず電源スイッチを必ず切ってください。 	<ul style="list-style-type: none"> ● パネルやカバーを取り外したまま機械操作をしないで下さい。 	Japanese 注意事項
<ul style="list-style-type: none"> ● 頭部遠離煙霧。 ● 在呼吸區使用通風或排風器除煙。 	<ul style="list-style-type: none"> ● 維修前切斷電源。 	<ul style="list-style-type: none"> ● 儀表板打開或沒有安全罩時不準作業。 	Chinese 警告
<ul style="list-style-type: none"> ● 얼굴로부터 용접가스를 멀리하십시오. ● 호흡지역으로부터 용접가스를 제거하기 위해 가스제거기나 통풍기를 사용하십시오. 	<ul style="list-style-type: none"> ● 보수전에 전원을 차단하십시오. 	<ul style="list-style-type: none"> ● 판넬이 열린 상태로 작동치 마십시오. 	Korean 위험
<ul style="list-style-type: none"> ● ابعِد رأسك بعيداً عن الدخان. ● استعمل التهوية أو جهاز ضغط الدخان للخارج لكي تبعد الدخان عن المنطقة التي تتنفس فيها. 	<ul style="list-style-type: none"> ● اقطع التيار الكهربائي قبل القيام بأية صيانة. 	<ul style="list-style-type: none"> ● لا تشغيل هذا الجهاز اذا كانت الاغطية الحديدية الواقية ليست عليه. 	Arabic تحذير

LEIA E COMPREENDA AS INSTRUÇÕES DO FABRICANTE PARA ESTE EQUIPAMENTO E AS PARTES DE USO, E SIGA AS PRÁTICAS DE SEGURANÇA DO EMPREGADOR.

使う機械や溶材のメーカーの指示書をよく読み、まず理解して下さい。そして貴社の安全規定に従って下さい。

請詳細閱讀並理解製造廠提供的說明以及應該使用的銀焊材料，並請遵守貴方的有閣勞動保護規定。

이 제품에 동봉된 작업지침서를 숙지하시고 귀사의 작업자 안전수칙을 준수하시기 바랍니다.

اقرأ بتمعن وافهم تعليمات المصنع المنتج لهذه المعدات والمواد قبل استعمالها واتبع تعليمات الوقاية لصاحب العمل.



• World's Leader in Welding and Cutting Products •

• Sales and Service through Subsidiaries and Distributors Worldwide •

Cleveland, Ohio 44117-1199 U.S.A. TEL: 216.481.8100 FAX: 216.486.1751 WEB SITE: www.lincolnelectric.com

Download from [Www.Somanuals.com](http://www.Somanuals.com). All Manuals Search And Download.

Free Manuals Download Website

<http://myh66.com>

<http://usermanuals.us>

<http://www.somanuals.com>

<http://www.4manuals.cc>

<http://www.manual-lib.com>

<http://www.404manual.com>

<http://www.luxmanual.com>

<http://aubethermostatmanual.com>

Golf course search by state

<http://golfingnear.com>

Email search by domain

<http://emailbydomain.com>

Auto manuals search

<http://auto.somanuals.com>

TV manuals search

<http://tv.somanuals.com>